



University of HUDDERSFIELD

University of Huddersfield Repository

A-Yarubi, Qahtan and Lucas, Gary

Measurement of the Film Thickness, Film Velocity and Entrainment Fraction in a Liquid-Air Annular Flow Using a Conductance Flowmeter

Original Citation

A-Yarubi, Qahtan and Lucas, Gary (2009) Measurement of the Film Thickness, Film Velocity and Entrainment Fraction in a Liquid-Air Annular Flow Using a Conductance Flowmeter. In: Conference of the International Journal of Arts & Sciences, 23-26 February 2009, Malta.

This version is available at <http://eprints.hud.ac.uk/id/eprint/3655/>

The University Repository is a digital collection of the research output of the University, available on Open Access. Copyright and Moral Rights for the items on this site are retained by the individual author and/or other copyright owners. Users may access full items free of charge; copies of full text items generally can be reproduced, displayed or performed and given to third parties in any format or medium for personal research or study, educational or not-for-profit purposes without prior permission or charge, provided:

- The authors, title and full bibliographic details is credited in any copy;
- A hyperlink and/or URL is included for the original metadata page; and
- The content is not changed in any way.

For more information, including our policy and submission procedure, please contact the Repository Team at: E.mailbox@hud.ac.uk.

<http://eprints.hud.ac.uk/>

Measurement of the Film Thickness, Film Velocity and Entrainment Fraction in a Liquid-Air Annular Flow Using a Conductance Flowmeter

Q. Al-Yarubi, University of Huddersfield, UK
Prof. G.Lucas, University of Huddersfield, UK

Abstract: In certain older oil wells in the Middle East, the produced fluid is predominantly natural gas which flows at very high rates (e.g. $50,000 m^3 / day$). Smaller quantities of crude oil (e.g. $50 m^3 / day$) and water ($950 m^3 / day$) are also produced. Given the relatively much higher flow rate of the gas the flow regime is annular with most of the liquid flowing in a thin film on the pipe wall. The annular flow regime makes measurement of the total liquid flow rate difficult. It is even more difficult to measure the individual flow rate of either the oil or the water. In a vertical Perspex pipe (i.d. = 50 mm) using a newly-designed flow loop in the University of Huddersfield, annular flow was established and different measurements were carried out. At the first stage, only water-air annular flow was being used to investigate the possible measurement techniques to achieve the aim of this study. The techniques in this study include the use of conductivity probes to measure the liquid film thickness and to obtain the film velocity using the cross-correlation technique. The obtained results were compared to previous work by Zabaras and Dukler for the same pipe diameter. The results of the present work have shown a good agreement with Zabaras and Dukler's work which indicates the success of the new measurement techniques.

1. Introduction

Annular flow widely occurs in many industrial processes such as flow channels in nuclear reactors, steam generation and power plants, heating and refrigeration equipment and during transportation of crude oil and natural gas. In its simplest form, the flow is characterized by a gas core (gas phase with entrained liquid droplets) flowing in the centre of the tube and a liquid film flowing on the inner tube wall.

In this study, the following major features of annular flow were taken into account: the liquid film thickness (δ), liquid film velocity (V_f) and entrainment fraction (E). A conductance flow meter was designed which provides the film thickness at two points i.e. upstream and downstream. By cross correlating the two thickness signals from the flow meter probes, the film velocity can be obtained. The importance of liquid films in a wide variety of industrial processes has led to extensive experimental investigations into the phenomenon of film flow. In particular, knowledge of the thickness of these liquid films is useful in equipment design. As film thicknesses in two-phase applications are generally less than a few millimeters, accurate measurement is difficult, and this has led to the development of a diverse range of measurement techniques. A similar observation is valid for entrainment measurement. In general, the most common methods reported in the literature for entrainment fraction measurements can be categorized into two main groups: (a) the sampling probe method, and (b) the liquid film removal method.

2. Experimental Arrangement

Flow facility: The annular flow is established in an acrylic pipe, called the test section, for ease of visualisation. The outlet of the test section is either passed to a separator or to a storage tank as in our case. The idea of the annular flow rig designed for this study was generated from the idea of combining a water line with an air supply. The air supply was taken from the compressed air supply from the main university compressor. The water line was obtained from an existing flow facility at the University of Huddersfield.

In the experiments, air and water were supplied at room temperature and near atmospheric pressure conditions. The loop consists of four sections (Fig. 1) 1) an air supply section, 2) a water supply section, 3) a test section, 4) an outlet section. In the air supply section, the air flow rate is controlled by a hi-flow pressure regulator (FAIRCHILD 100) and measured by a rotameter (ABLE VA METER 50PTnAAI75) with an accuracy of 2%. Typical water and air flow rates which enable annular flow to be achieved are: $Q_w \cong 29L/\text{min}$ and $Q_g \geq 2940L/\text{min}$ respectively.

Conductance Probe: This method is the most commonly implemented film thickness measurement technique due to its relative ease of use and general applicability to most flow systems. For a conducting liquid such as water, film thickness can be determined by a calibrated linear relationship that can be established between probe conductance and the film thickness, within the range of measurements. In this study's approach, the electrodes are two parallel thin stainless steel needles which together form a 'probe'. These electrodes protrude from the pipe wall supported only at one end. As the film thickness increases, the surface area of electrodes covered by water increases and the resistance decreases. An inverting amplifier is used for each probe which gives an output voltage proportional to the measured probe conductance. The film thickness/output voltage relationship is obtained by calibration. For the flow meter described in this paper, two conductance probes were used in a pipe of 50mm internal diameter. The axial separation between the probes was 70mm.

For each probe, the electronic circuitry involves the application of a high frequency, constant amplitude A.C. voltage from a sine wave signal generator across the electrode pair. The 'film thickness dependent' output voltage from the circuit is then measured. The designed circuit consists of: (A) An inverting amplifier which provides an output voltage proportional to the probe conductance, (B) Non-inverting amplifier, (C) Full wave rectifier, (D) Low-pass filter, (E) Non-inverting amplifier, (F) Zero offset adjust and (G) RC ripple filter. A bench test was run before designing the flow meter to obtain the best separation between the two electrodes of each probe to reduce the effect of the meniscus. A 20 mm distance between the electrodes was found to be a reasonable separation with a fairly linear output. The calibration method was performed on a laboratory bench. It was accomplished by placing different sizes of solid cylindrical cores concentrically located in the main body of the flow meter. The gap between the pipe inner diameter and the outer diameter of the solid cores represents the annular film when the flow meter is filled with water during the calibration process. The calibration was performed and gave the following equation for both probes:

$$y = 0.0699\delta - 0.0039 \quad (1)$$

where: y is the output voltage and δ is the water film thickness. The two electrodes of each probe had an outer diameter is 1.2 mm. The flow meter, Fig. 2, was made of Perspex pipe of 50 mm internal diameter to match the test section inner diameter.

Two boss connections were fitted to the pipe to hold the probes and were machined to match the shape of the inner surface of the main flow meter body.

3. Data Acquisition & Control System

Data acquisition was performed via a computer based system. Most flow loop controls were automated by using a Matlab program. However the valves controlling the air and water flow rates were adjusted manually. Data were collected at a sampling rate of 1 KHz for each probe. A USB based data acquisition module was used to record the data.

4. Measurements And Results

Using the conductivity flow meter, the film thickness was measured at different flow conditions. Fig. 3 shows a plot of film thickness from the upstream and downstream probes of the flow meter. The cross correlation technique has been implemented in this study to achieve the film velocity measurement. Cross-correlation is the process of matching two similar signals as a function of the time delay between them. The principle involves calculating the sum of the differences between the two signals at every acquired point. This process can be summarised by:

$$R_{xy}(\tau) = \lim_{T \rightarrow \infty} \frac{1}{T} \int_0^T x(t-\tau).y(t)dt \quad (2)$$

Where: $R_{xy}(\tau)$ is defined as the cross-correlation function and the two sensors are referred to as x and y. T is the total time period for which data was acquired. Unless normalised, the magnitude of $R_{xy}(\tau)$ is proportional to the magnitudes of the input signals.

By applying a simple calculation on any random flow condition, say $Q_{w,ref} = 4.172 \times 10^{-4}$ m³/s, hence the area of the film $A_f = 3.0578 \times 10^{-4}$ m², a 'reference' transit time τ_t of liquid in the film between the two probes is given by

$$\tau_t = \frac{A_f L}{Q_{w,ref}} \quad (3)$$

where L is the axial probe separation. For the flow condition under consideration equation 3 gives a value of 52 ms for τ_t .

By applying the cross-correlation technique on the output voltages from the two conductance probes at this flow condition, Fig. 4, shows that the time τ_p for the peak value of the correlogram occurs at 55.5 ms which is in a fair agreement with the value for τ_t given above.

Cross correlation film velocity readings were obtained for a range of flow conditions and a percentage error ξ defined as follows was calculated.

$$\xi = \frac{\frac{L}{\tau_p} - \frac{L}{\tau_t}}{\frac{L}{\tau_t}} \quad (4)$$

Fig. 5, shows a negative value for ξ for all flow conditions - which is very predictable. The reason behind this is due to the assumption that all of the water is in the film whereas actually some water is entrained as drops in the core. In annular flow, part of the liquid flows in the form of a film on the tube wall while the other part flows as entrained liquid droplets in the gas core. This phenomenon is called entrainment.

If $Q_{f,m}$ is the measured water flow rate in the film:

$$Q_{f,m} = U_{w,f,xcor} A_f \quad (5)$$

and Q_e is the water flow rate in the core:

$$Q_e = Q_{w,ref} - Q_{f,m} \quad (6)$$

So, the entrainment fraction, E, can be given by:

$$E = \frac{Q_e}{Q_e + Q_{f,m}} \quad (7)$$

Further investigation was carried to ensure that the above measurements are satisfactory. The present study was compared to a previous study carried by Zabararas and Dukler. To make the investigation more feasible and clear, the units of the flow rates were converted to mass flow rates since Zabararas and Dukler presented their results in mass flow rates. As predicted, the liquid film thickness decreases as the gas flow rate increases, Fig. 6. At higher liquid superficial velocities, a greater reduction in the film thickness occurs than with the lower liquid superficial velocities.

Eq.5, eq6 & eq.7 were applied to obtain the required measurements. The obtained results show a similar trend with Zabararas and Dukler's readings. As the gas mass flow rate increases, the entrainment mass flow rate increases till a dry out point starts to occur, Fig. 7. This increase is more dependent on the gas flow rate than the liquid flow rate due to the effect of the gas shearing off the liquid. Zabararas and Dukler results agreed with Smith et al. results. Fig. 8 gives an idea about the behavior of the entrainment fraction as the gas flow rate increases for different liquid feed Reynolds number. It shows that the entrainment fraction is mostly dependent on the gas flow rate. Fig. 9 shows that the entrainment fraction increases more in the direction of increasing the gas superficial velocity i.e. gas flow rate. This is due to the increase in the ability of the gas phase shearing off the liquid film. Comparing the flow rate of the liquid film, Fig. 10, it fits with the trend of the study by Zabararas and Dukler. The characteristic trend of the liquid film flow rate seems to be increasing to a maximum point as the gas flow rate increases, then starts to be constant till a dry out phenomenon occurs. Another liquid flow rate independency is the liquid film velocity. Fig. 11 shows that the liquid film velocity increases in the direction of increase of the gas flow rate. However, it can be seen that this does not depend on the liquid flow rate as the three shown plots scatter within each other.

5. Summary

These data are presented for vertical upward annular flow. Analysis of these data in a variety of ways suggests that the designed conductivity flow meter is able to measure the film thickness to a good accuracy. The new adapted technique of cross-correlation works very well in term of measuring the liquid film velocity provided that an enough sampling rate is being used. This can be verified when results were compared to some previous work. The measurement of the entrainment fraction shows a great independency of the liquid flow rate. The gas flow rate has the major influence on both the entrainment and the liquid film velocity. From this measurement technique, the liquid flow rate, $Q_{f,m}$, can be measured by assuming the entrainment fraction, E , depends on the gas flow rate.

Overall, good quantitative and qualitative agreements were obtained between the present work and a previous in similar experimental situation but different techniques.

References

- Zabaras G., Dukler A. E. and Moalem-Maron D. (1986). Vertical Upward Cocurrent Gas-Liquid Annular Flow. *AIChE JOURNAL* May 1986.
- Smith L., Chopra A. and A. E. Dukler (1984). Flooding and Upward Film Flow in Tubes. I: Experimental studies. *Int. J. Multiphase Flow*. 10,585 (1984).

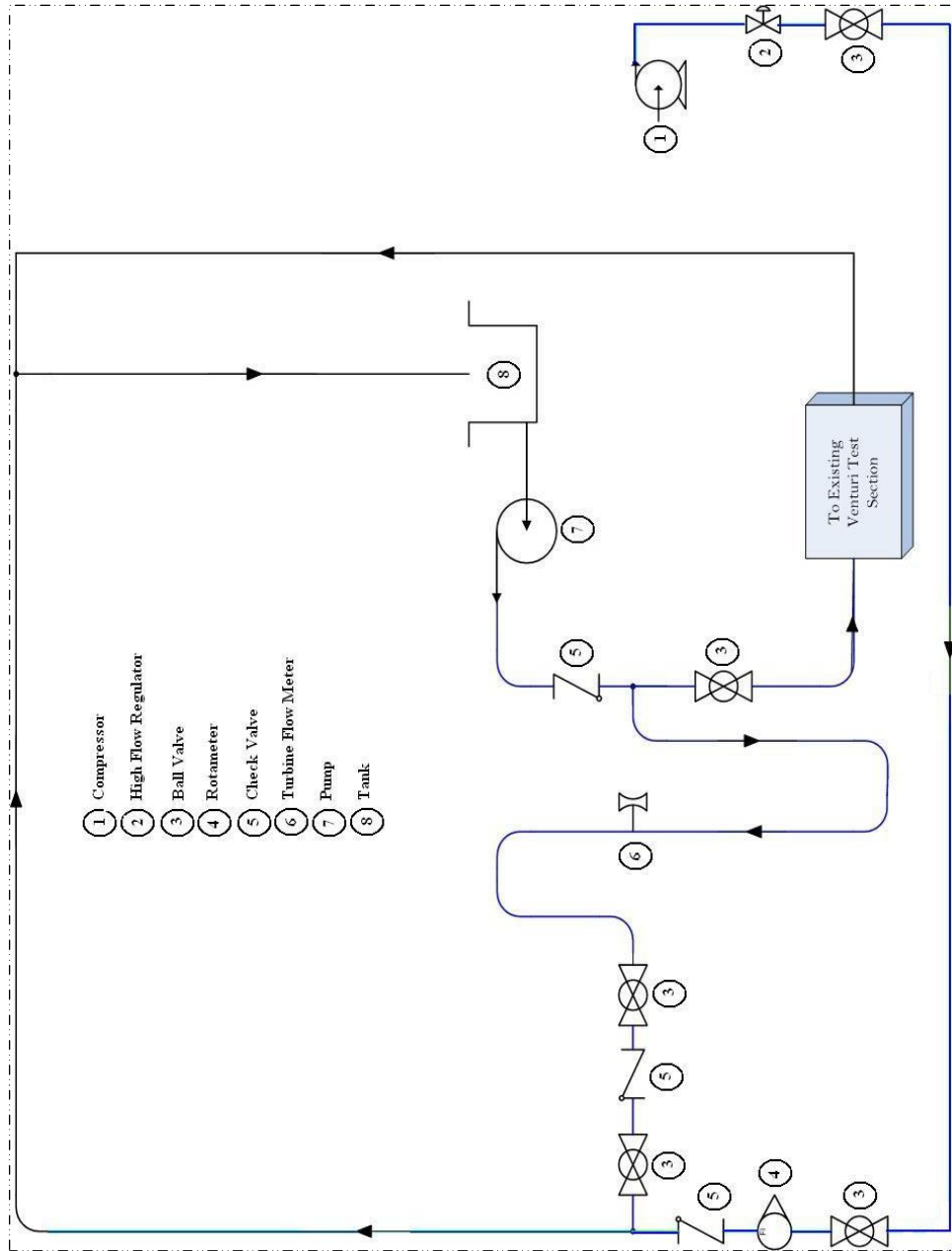

Figure 1 Schematic of flow facility

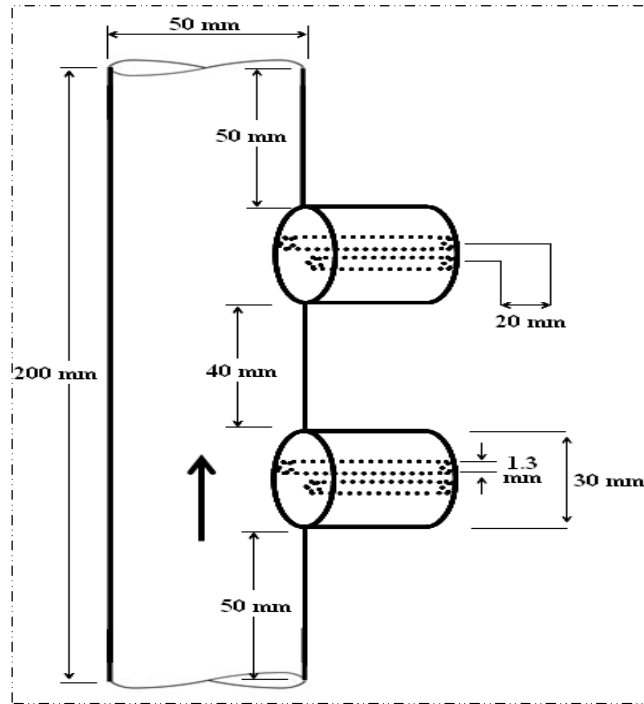

Figure 2 Conductance Flow Meter

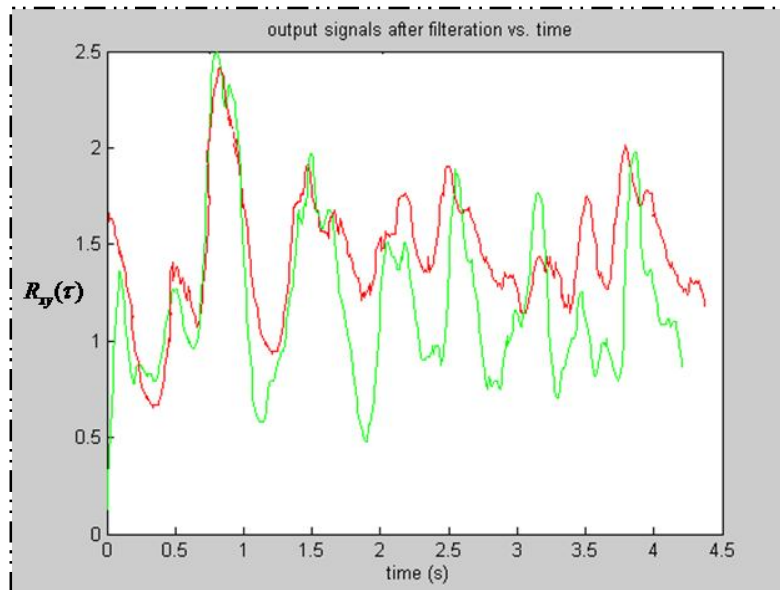

Figure 3 Film thickness signals from both upstream and downstream sensors

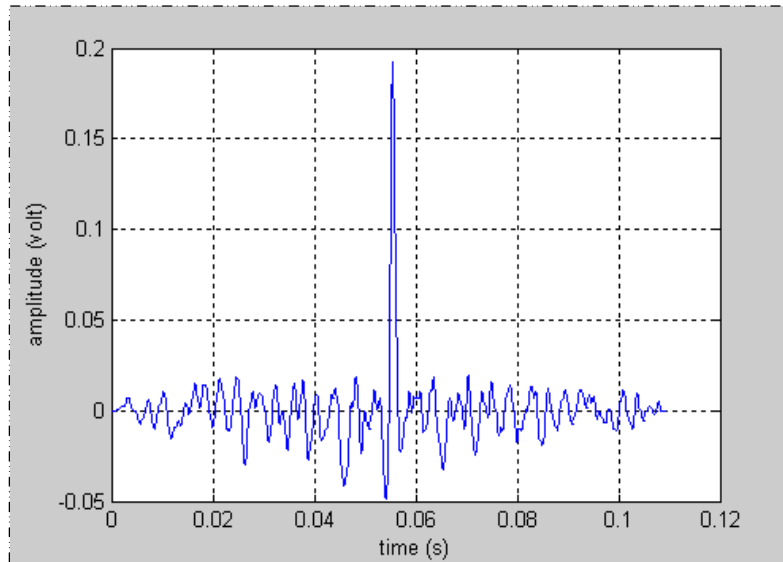

Figure 4 Cross-correlating two signals of a given flow condition

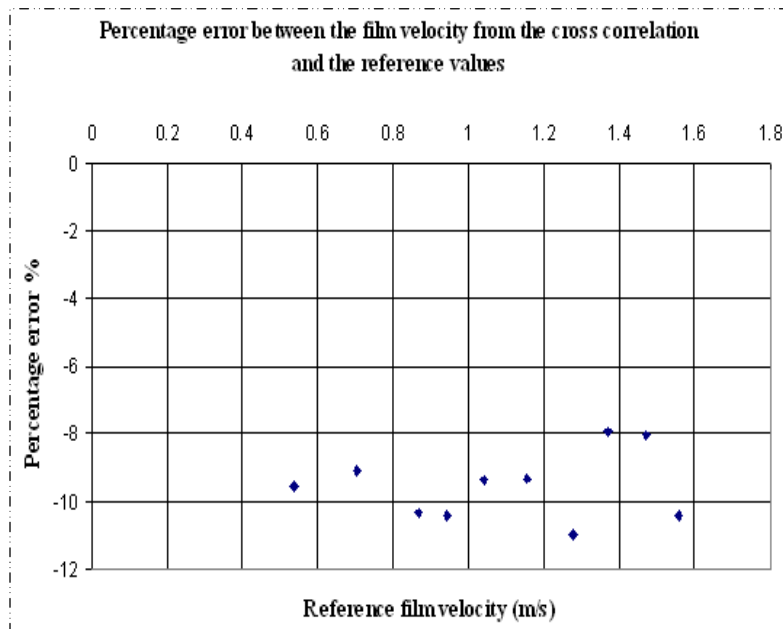

Figure 5 Percentage error

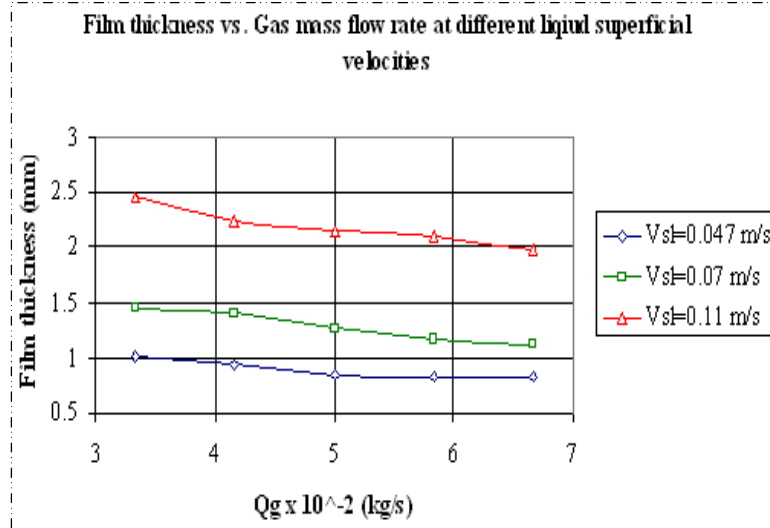

Figure 6 Liquid film thicknesses at different liquid superficial velocities

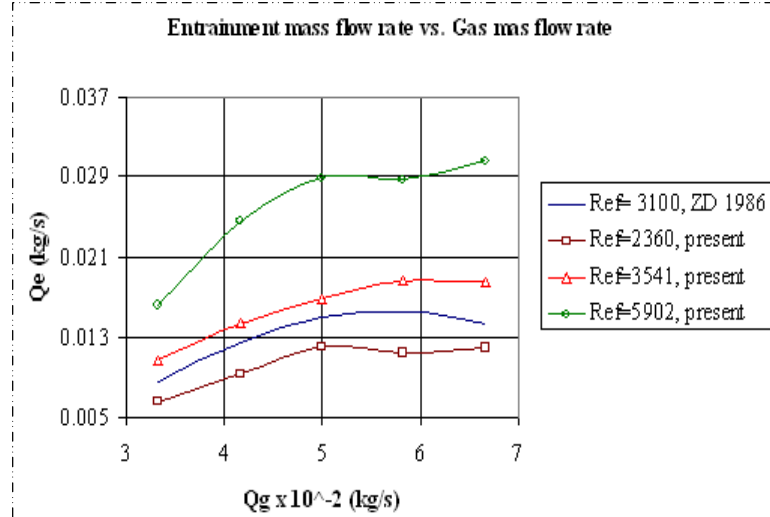

Figure 7 Entrainment mass flow rate at different liquid feed Reynolds number

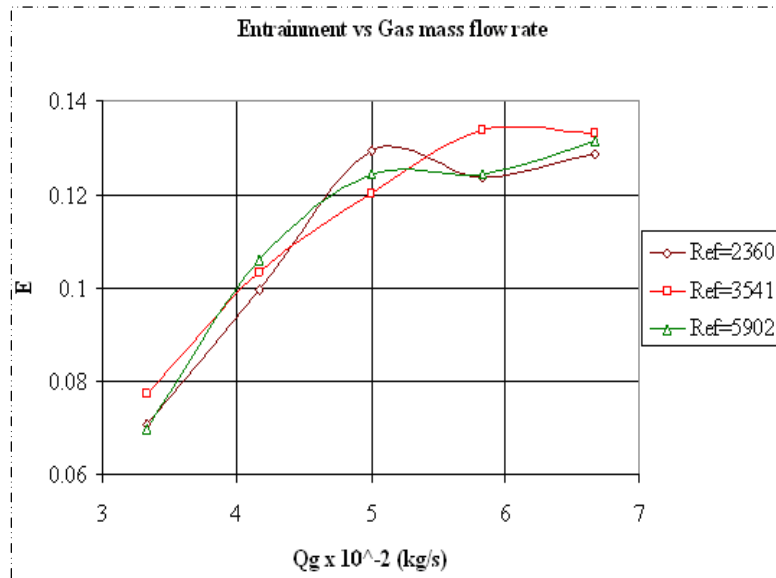

Figure 8 Entrainment at different liquid feed Reynolds number

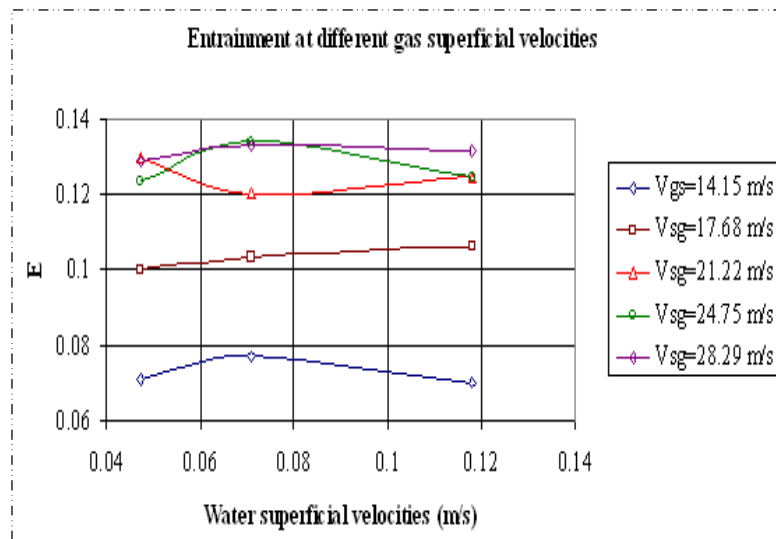

Figure 9 Entrainment at different gas superficial velocities

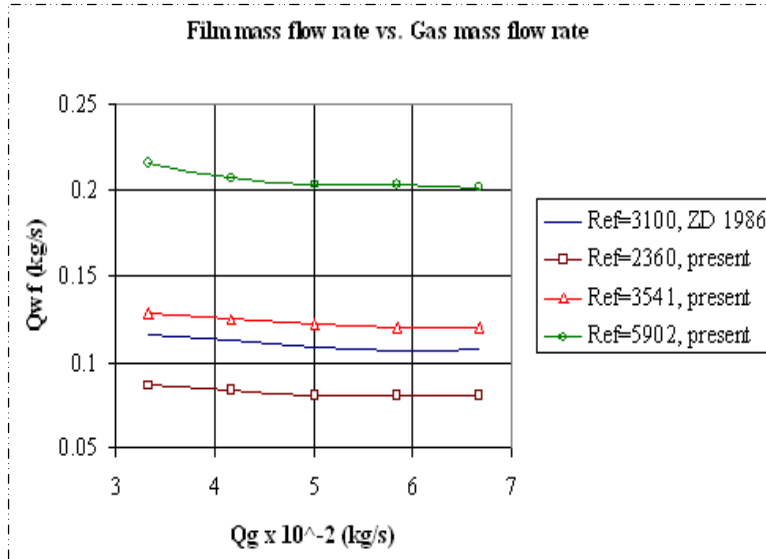

Figure 10 Liquid film mass flow rate at different liquid feed Reynolds number

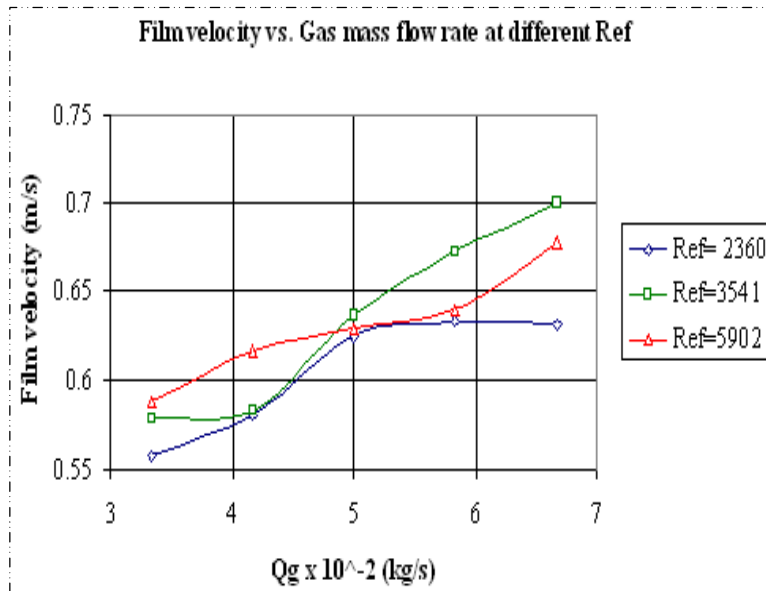

Figure 11 Liquid film velocity at different liquid feed Reynolds number