



University of HUDDERSFIELD

University of Huddersfield Repository

Raharjo, Parno, Tesfa, Belachew, Gu, Fengshou and Ball, Andrew

A Comparative Study of the Monitoring of a Self Aligning Spherical Journal using Surface Vibration, Airborne Sound and Acoustic Emission

Original Citation

Raharjo, Parno, Tesfa, Belachew, Gu, Fengshou and Ball, Andrew (2012) A Comparative Study of the Monitoring of a Self Aligning Spherical Journal using Surface Vibration, Airborne Sound and Acoustic Emission. *Journal of Physics: Conference Series*, 364. 012035. ISSN 1742-6596

This version is available at <http://eprints.hud.ac.uk/id/eprint/14189/>

The University Repository is a digital collection of the research output of the University, available on Open Access. Copyright and Moral Rights for the items on this site are retained by the individual author and/or other copyright owners. Users may access full items free of charge; copies of full text items generally can be reproduced, displayed or performed and given to third parties in any format or medium for personal research or study, educational or not-for-profit purposes without prior permission or charge, provided:

- The authors, title and full bibliographic details is credited in any copy;
- A hyperlink and/or URL is included for the original metadata page; and
- The content is not changed in any way.

For more information, including our policy and submission procedure, please contact the Repository Team at: E.mailbox@hud.ac.uk.

<http://eprints.hud.ac.uk/>

A Comparative Study of the Monitoring of a Self Aligning Spherical Journal using Surface Vibration, Airborne Sound and Acoustic Emission

P Raharjo, B Tesfa, F Gu and A D Ball

School of Computing and Engineering, University of Huddersfield,
Queensgate, Huddersfield, HD1 3DH, UK

E-mail: U0874514@hud.ac.uk

Abstract. A Self aligning spherical journal bearing is a plain bearing which has spherical surface contact that can be applied in high power industrial machinery. This type of bearing can accommodate a misalignment problem. The journal bearing faults degrade machine performance, decrease life time service and cause unexpected failure which are dangerous for safety issues. Non-intrusive measurements such as surface vibration (SV), airborne sound (AS) and acoustic emission (AE) measurement are appropriate monitoring methods for early stage journal bearing fault in low, medium and high frequency. This paper focuses on the performance comparison using SV, AS and AE measurements in monitoring a self aligning spherical journal bearing for normal and faulty (scratch) conditions. It examines the signals in the time domain and frequency domain and identifies the frequency ranges for each measurement in which significant changes are observed. The results of SV, AS and AE experiments indicate that the spectrum can be used to detect the differences between normal and faulty bearing. The statistic parameter shows that RMS value and peak value for faulty bearing is higher than normal bearing.

Keyword: Self aligning spherical journal bearing, Surface vibration, Airborne sound, Acoustic-emission, Scratching.

1. Introduction

Bearings are critical parts of rotating machines, which are key machine components ensuring safety and efficient operation. The function of this element is to support the load and transfer power and rotation. There are two broad types of bearing widely used in machinery: journal and roller bearings. The self-aligning spherical journal bearing consists of a spherical plain bearing which has a spherical contact surface and permits the bearing to move freely in all directions. This gives the capability to self-align, which means it can accommodate a degree of misalignment. This bearing uses an oil ring lubrication system. The self-aligning spherical journal bearing (SASJB) is a relatively new type of journal bearing [1].

The study of the vibro-acoustic characteristic of the bearing has shown relatively little information especially for faulty journal bearing characteristics. Experience has indicated that most machinery problems are caused by bearing failure, with over 40% of motor failures in machines of 100HP (75kW) or more, due to bearing problems [2]. Induction machine failure surveys have found that the most common failure causes are bearing related faults (40%), stator related (36%) and other faults (22%) [3]. Clevite also reported that the most common causes of premature machine bearing failure

are the ingress of dirt (45%), misassemble (13%), misalignment (13%), insufficient lubrication (11%), overloading (8%), corrosion (4%), improper journal finish (3%), and other (3%) [4].

The SASJB may be relatively cheap, but because it transmits high powers if it is damaged it may fail catastrophically which could include not only loss of production and complete loss of the machine, but also serious health and safety issues.

Based on the time frame in which the event occurs failure can be classified as maladjustment, out of tolerance intermittent, and catastrophic, based on their severity [5]. The presence of contaminants in the bearing system is the most common cause of bearing failure. The contaminant can be solid, liquid or gas, and it may originate from external and/or internal sources for examples from the environment such as sand and wear particles. It can cause high friction, wiping damage and loss of clearance. Wiping damage is the rubbing of the journal bearing in the absence of a hydrodynamic lubricating film, possibly at start-up before a film has developed. Loss of clearance in the journal bearing causes wiping at bearing centre.

An inadequate supply of lubricant can occur due to too low viscosity lubricant, too high bearing temperature, misalignment between the shaft and the bush and excessive load. The other major problem of bearing faults is wear. Wear is subsurface fatigue that occurs after many working cycles which apply a high-stress to the metal. The wear can be divided into abrasive wear, adhesive wear, erosion wear and corrosive wear. Abrasive wear or scratching is the most common form of wear in lubricated machinery and occurs with contact, usually due to particle contamination. Two-body abrasion occurs when the metal surface roughness on one surface cuts directly into a second metal surface [6].

The failure of a machine bearing commonly leads to serious problems including the need for a complete overhaul. The early detection of the symptoms of faults that could lead to failure in journal bearings is crucial to allow remedial action to be taken to prevent possible catastrophic failure. By undertaking bearing condition monitoring, early faults and symptoms of failure can be detected, so that catastrophic failure can be avoided.

Based on the interaction contact between two surfaces in relative motion, monitoring techniques can be deployed in the early wear regime, such as lubricating oil analysis (fluid property, fluid contamination and wear debris analysis), vibro-acoustic analysis (vibration, vibro-acoustic and acoustic emission analysis) and bearing performance analysis (temperature, pressure and thermograph analysis). Lubricant analysis has been applied for many years. The railway companies in the United States started using this approach in the late 1940s [7].

Today, vibration analysis is one of the most commonly used condition monitoring techniques in industry. It has the great advantage that it yields relevant data in a quantitative format and can be operated remotely in real-time. Based on the measured signal, pre-set alarm limits can be triggered automatically [8].

Acoustic or sonic analysis is the measurement of sound pressure waves generated by component contact inside equipment and radiated from the surface of the machine. The acoustic analysis application in industry with respect to monitoring bearing faults is relatively new [9].

Acoustic emission (AE) is an inspection technique which detects elastic waves generated by such sources as cracking, cleavage, fretting and so forth. To treat AE waves theoretically, elasticity dynamics is needed to model AE sources and solve the wave propagation equations [10]. The surface vibration, sound acoustic and acoustic emission is suitable for SASJB monitoring techniques.

2. Sources of Surface Vibration, Airborne Sound and Acoustic Emission

Vibration accompanies the working of all machinery, but excessive vibration, noise and energy emission are usually a warning of a developing fault. Vibration is a repetitive, periodic, or oscillatory response of a mechanical system to an applied force.

2.1. Surface vibration source

Vibration can occur naturally in machinery and will be representative of its free and natural behaviour. Vibration may also be forced by some applied excitation [11]. There are three common parameters used to measure vibration, depending on the frequency range. The displacement of the vibrating surface is usually used in analyzing low frequency vibration ($< 10\text{Hz}$), the vibration velocity is used for vibration in the range of about 10Hz to 1kHz and the vibration acceleration is used to analyze higher frequency vibration phenomena ($> 1\text{kHz}$) [12]. Spherical self-aligning journal bearing may be modelled as a rotating spherical mass system, see Figure 1. The rotating mass system model of self-aligning spherical journal bearing vibration contains damped forced vibration of 6 degrees of freedom. However, a simplified model using damped forced vibration with 4 degrees of freedom can be obtained by neglecting torsion (θ_x) motion and displacement in the x direction. Torsion and axial load in the x direction are relatively small. A schematic diagram of transverse vibration in the y and z direction is shown in Figure 2.

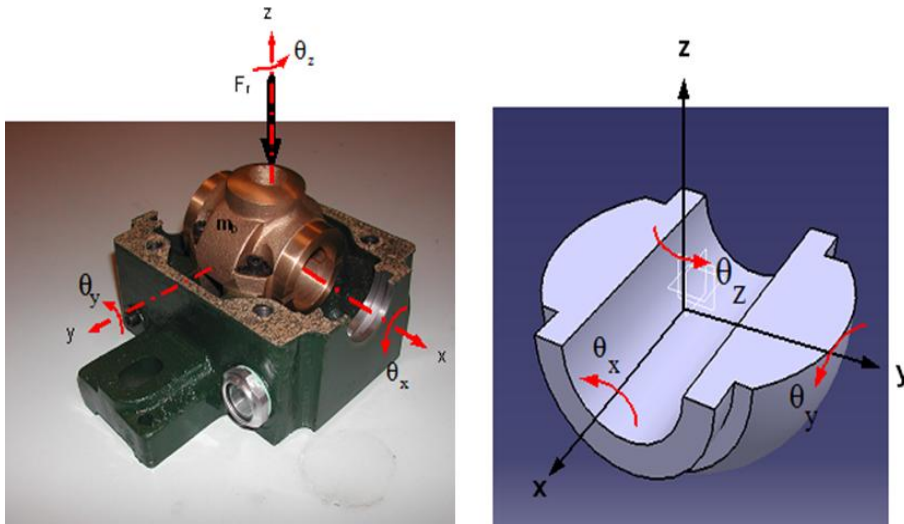

Figure 1. Rotating spherical mass system on SASJB.

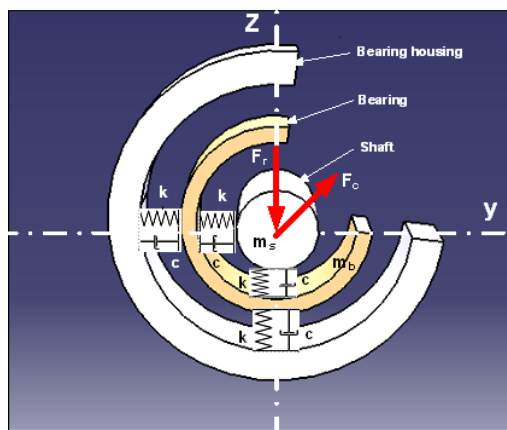

Figure 2. Schematic diagram of transverse vibration in y and z directions.

The bearing receives combination radial load and torsion load. The radial load consists of radial load in z axis (F_z) and centrifugal load in y axis (F_{cy}). Torsion load can come from a torsion on the y axis (T_y) and torsion on the x axis (T_x). The torsion load depends on the power and speed. This dynamic vibration system is influenced also by mass of shaft (m_s), mass of bearing (m_b) and mass

moment of inertia (J) of bearing. The contact between shaft and bearing also between bearing and bearing housing are separated by stiffness (k) and damping coefficient (c) for radial direction load. When the bearing under torsion load contact between shaft and bearing are influenced by torsion stiffness (k_t) and torsion damping coefficient (c_t). The stiffness and the damping coefficient are determined by asperity contact characteristics including surface accuracy, material and viscosity of lubricant.

If [M] is mass matrix, [C] is damping matrix, [K] is stiffness matrix and {F} is force or torsion vector for multiple degrees of freedom, the equations of motion for the vibration may be written in the following matrix notation.

$$[M]\{\ddot{y}\} + [C]\{\dot{y}\} + [K]\{y\} = \{F\} \quad (1)$$

Where the mass matrix, damping matrix, linear and angular acceleration vector, stiffness matrix, linear and angular velocity vector, linear and angular displacement vector and force or torsion vector as follows:

$$|M| = \begin{bmatrix} m_s & 0 & 0 & 0 & 0 & 0 \\ 0 & m_b & 0 & 0 & 0 & 0 \\ 0 & 0 & m_s & 0 & 0 & 0 \\ 0 & 0 & 0 & m_b & 0 & 0 \\ 0 & 0 & 0 & 0 & J & 0 \\ 0 & 0 & 0 & 0 & 0 & J \end{bmatrix} \quad |C| = \begin{bmatrix} c & -c & 0 & 0 & 0 & 0 \\ 0 & -c & 2c & 0 & 0 & 0 \\ 0 & 0 & c & -c & 0 & 0 \\ 0 & 0 & 0 & -c & 2c & 0 \\ 0 & 0 & 0 & 0 & c_t & 0 \\ 0 & 0 & 0 & 0 & 0 & c_t \end{bmatrix} \quad \{\ddot{y}\} = \begin{matrix} \ddot{z}_1 \\ \ddot{z}_2 \\ \ddot{y}_1 \\ \ddot{y}_2 \\ \ddot{\theta}_y \\ \ddot{\theta}_z \end{matrix} \quad (2)$$

$$|K| = \begin{bmatrix} k & -k & 0 & 0 & 0 & 0 \\ 0 & -k & 2k & 0 & 0 & 0 \\ 0 & 0 & k & -k & 0 & 0 \\ 0 & 0 & 0 & -k & 2k & 0 \\ 0 & 0 & 0 & 0 & k_t & 0 \\ 0 & 0 & 0 & 0 & 0 & k_t \end{bmatrix} \quad \{\dot{y}\} = \begin{matrix} \dot{z}_1 \\ \dot{z}_2 \\ \dot{y}_1 \\ \dot{y}_2 \\ \dot{\theta}_y \\ \dot{\theta}_z \end{matrix} \quad \{y\} = \begin{matrix} z_1 \\ z_2 \\ y_1 \\ y_2 \\ \theta_y \\ \theta_z \end{matrix} \quad \{F\} = \begin{matrix} F_z \\ 0 \\ F_{cy} \\ 0 \\ T_y \\ T_z \end{matrix} \quad (3)$$

The Matlab 2nd – 3rd order Ordinary Differential Equation (ODE) solver with variable steps is used to solve the six degree of freedom equation of motion described above.

The journal bearing under higher external load and speed will cause higher vibration amplitude. If the bearing use a lower viscosity of lubricant it will result in the depletion of oil film and increases the asperity area or multi-asperity contact. Contact time for a single pointed asperity can be very fast; therefore the vibration response occurs at high frequency in random signals.

2.2. AE in a self aligning journal bearing

Vibration analysis is a commonly used CM technique for rotating machines but the accelerometer used for vibration measurement only detects signal in the sonic frequency range (<20KHz) and not signals in ultrasonic frequency range (>20kHz). The frequency range of AE signals extends from the audible to the ultrasonic range up to and above 100 kHz [13].

AE is the phenomenon of transient elastic wave generation in a material under stress. When materials are subjected to stress above a certain level, a rapid release of strain energy takes places in the form of elastic waves which can be detected by an AE transducer placed close by [14]. AE has

been detected from a tribosystem, i.e. a system of tribological components which rub against or slide over each other, generating friction and wear, such as bearings [15]. The sources of AE signals generated by mechanical loading and failure of materials include such friction effects as plastic deformation, change in surface structure and appearance of wear debris and formation of fatigue pits. Journal bearings reduce friction for really heavy shafts in sliding contact, therefore AE signal analysis may be of use in detecting journal bearing early failure.

When two solid bodies are in contact with each other, the true contact between them occurs at only a limited number of points. The pressures on those points are very high and this asperity contact was found to be the main acoustic emission source in sliding friction [16]. The two components of a bearing are usually separated to a certain degree by a lubricant film. If the lubricant film is thick enough to fully separate the components' surfaces, then the friction coefficient is reduced and that results in longer bearings life.

AE analysis is an appropriate measurement to detect incipient failure of sliding bearings because of the correlation between emitted acoustic signal and energy dissipated in the sliding metallic contact, resulting in substantial increase of the signal amplitude in the frequency range around 100 kHz. Damage or failure can be recognized independently by contact geometry, sliding speed, shell and lubricant temperatures [15]. There will be a relationship between AE and power loss; if the increase in AE signal is due to increased asperity contact there will be increased friction and increased power loss. [17].

The acoustic emission energy magnitude is influenced by external load, component materials, roughness or asperity, geometrical occurrence and lubricant viscosity. The increasing of these parameters may create the acoustic emission energy amplitude increase except for lubricant viscosity.

2.3. The sound generation source

Sound is produced by every vibrating component of a machine or item of equipment, and travels as a wave through the surrounding air to reach the listener. Sound is a variation in local pressure in a medium that moves or transmits through the material at a speed which depends on the properties of the material. Noise produced by a machine or item of equipment may indicate the problems and need for maintenance [18].

Sound or noise can be evaluated both quantitatively and qualitatively. Quantitatively would be an overall measure of the sound level, qualitatively would include temporal and spectral characteristics. The quantitative level would be an indication of the presence of a fault and the qualitative measures would locate the fault. The acoustic transducer would usually be a microphone.

Noise from the machinery or rotating equipment can be aerodynamic, electromagnetic and structural or mechanical noise, with every component generating noise at a specific frequency corresponding to its natural frequencies [19].

In industry, aerodynamic noise is most commonly generated by pneumatic discharge systems, blow-off nozzles and leaking high pressure lines. However, aerodynamic noise also occurs where there is a large relative velocity between a solid object and the surrounding air, e.g. fan blades. The acoustic power generated is determined largely by the speed of the solid object. However, other factors can be important such as when the blades of a fan or pump pass a solid object and the fundamental frequency is the blade passing frequency.

Electromagnetic noise is produced by electromagnetic force that generate from the interaction between magnetic and the electrical supply in the electromotor. The magnetic noise amplitude appears at twice that of the electrical line frequency.

Structural noise is generated by mechanical vibration. Bearings are a major cause of such mechanical noise and this will be exacerbated if faults are present, e.g. lack of lubrication, misalignment, rotor unbalance and rubbing between bearing stator and bearing rotor. The production of hydrodynamic pressure within the journal bearing also generates noise. Noise is also generated by friction. Friction on two different materials' contact surface in sliding motion influences the energy of noise and vibration [20].

In a journal bearing the shaft rotate within the bearing. In this bearing oil is used to decrease the friction and prevent metal to metal contact between shaft and bearing. The shaft and bearing surface are not perfectly smooth, and when the shaft rotates in the bearing it will create a scraping or rubbing noise without an adequate layer of lubricating oil. However, the generation of hydrodynamic oil pressure in the journal bearing also creates noise. In the journal bearing, sound or acoustic wave travels in the radial direction from the component outwards through the lubricant (fluid), the bearing housing (solid) and the surrounding air.

3. Test Rig and Experiment Program

For investigation of self-aligning spherical journal bearing, the surface vibration, airborne sound and acoustic emission characteristics are used for early fault diagnosis. The test rig which is developed in the lab consists of an electrical motor drive, torque load system, measurement and data acquisition systems, hydraulic ram, hand pump, the self-aligning spherical journal bearing, load cell and main drive shaft and flexible hard rubber coupling. The torsion load was a 9.9kW DC generator placed at the end of the rig. The AC electrical drive motor 12.5 kW, 3-phase, 4 pole electric induction motor with maximum speed 1460 rpm was connected to the main test rig and DC generator by a hard rubber coupling. The test rig was equipped with one accelerometer to measure the vibration signal, one microphone to measure the near field acoustic signal and one AE sensor for each bearing as shown in Figure 3.

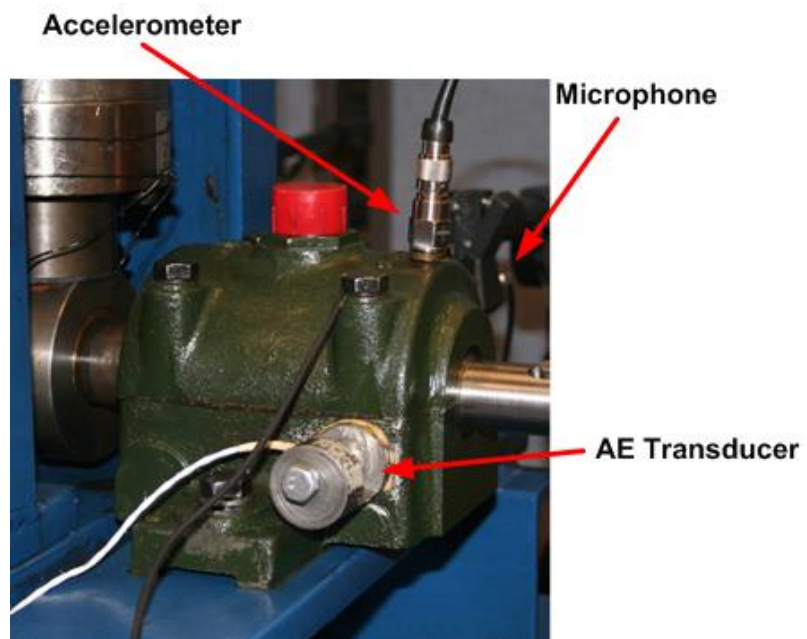

Figure 3. Accelerometer, microphone and AE sensor installation.

A Park 690 AC drive with Siemens Micro Master Controller was installed so that the motor could be run at different speeds and different torsion load. A Global Sensor Technology YE6232B, 16 channel, 16 bit, DAS system was employed to record all the measurements at a sampling rate of 96 kHz. The data was sent to Mathlab™ for analysis, diagnosis and interpretation.

The accelerometers attached to the test rig were Global Sensor Technology (GST) model CA-YD-185TNC. These were attached to the NDE bearing with frequency range 0.5 Hz to 5000 Hz and sensitivity 4.96mV/m/s². The accelerometers were attached to the bearing housing casing by a threaded bronze stud. The vibration transducers were each connected to DAS and then to the computer via a USB port.

The acoustic sensor or microphone was used to measure the airborne sound radiated from journal bearing to its surrounding. The microphones were GST model BAST YG 201 07067 for the DE

bearing and model BAST YG 201 07065 for the NDE bearing with 20Hz to 100 kHz \pm 0.2 dB range and 50 mV/Pa. The microphones were placed 200 mm away behind the accelerometer pick up. The microphone was directly connected to the DAS and then connected with the computer by USB.

The AE sensor was a Transducer Acoustic Emission, Physical Acoustic Corporation, Acoustic Group WD SN AJ64. The output signal from AE sensor was pre-amplified by 40 dB, type wideband AE Sensor, sensor name WD, sensor S/N FQ35, maximum value -64.50 dB, peak frequency 263,67 kHz and sensitivity dB ref 1V/ μ bar. The AE sensor was connected to the AE data acquisition system AEWin™ for PCI2 version E1.55 pre amplified by 40 dB.

The surface vibration, airborne sound and acoustic emission experiment were conducted by comparing the two journal bearings under different condition for the same speed and load. The bearing is a SA35M self aligning spherical journal bearing (DE bearing) with scratching fault and the second bearing (NDE bearing) as a reference. These experiments were conducted under constant torsion load 10% of the maximum value, 45.3N radial load and at speed variable 20, 40, 60, and 80% speed. Power maximum of the motor was 11kWatt. The bearing was lubricated by specified lubricant ISO VG 46.

Time-domain, frequency-domain and load correlation were used. In the time-domain, RMS, Peak value, Peak factor and Kurtosis of the signal were used to evaluate the vibration signal. In the frequency-domain, trending, descriptive and comparative analysis were also used. The self aligning spherical journal bearing with a scratching seeded faults every 2 mm along in the inner surface is shown in the figure 4.b and without scratching is shown in Figure 4.a.

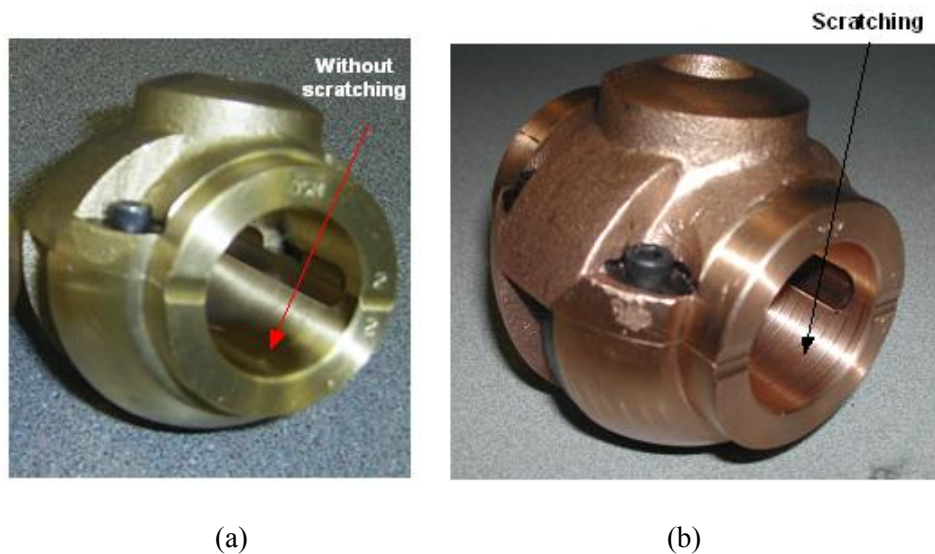

Figure 4. Self aligning spherical journal bearing normal and scratching.

4. Result and Discussion

The results of experiment are grouped in to surface vibration, airborne and acoustic emission measurement. The analysis uses time domain, spectrum, trending, comparative and statistical analysis parameter such as RMS value and Peak value.

4.1. Surface vibration measurement results

Figure 5 presents the surface vibration response in time-domain and frequency domain of a self-aligning journal bearing with and without scratching under 10% torsion load, 45.3N radial loads and at 80% speed. It appears that there is an insignificant difference between the amplitude of surface vibration signal of normal and scratching journal bearing.

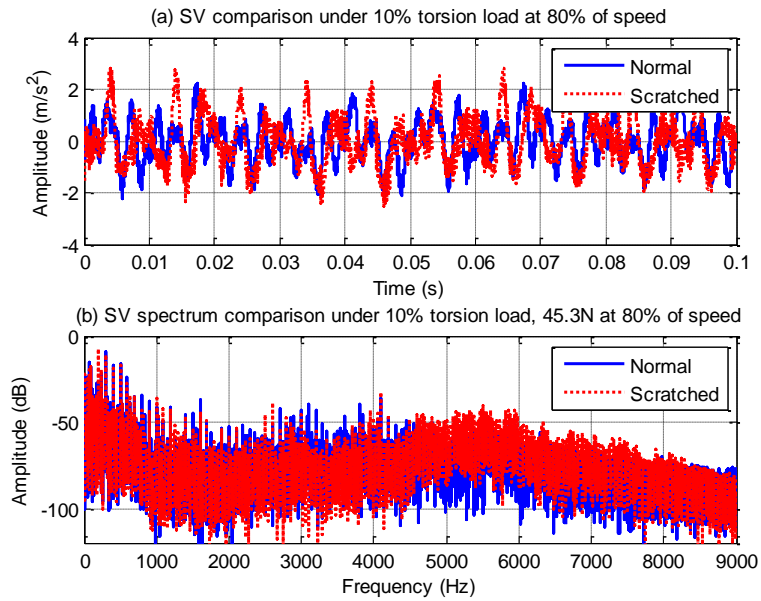

Figure 5. SV signal comparison between normal and scratching fault under 10% torsion load at 80% speed.

Figure 6 shows the frequency domain response of surface vibration on scratching and normal self-aligning spherical journal bearing under 45.3N, 10% torsion load and at speeds of 40%, 60% and 80% at high frequency: 4000Hz to 8000Hz

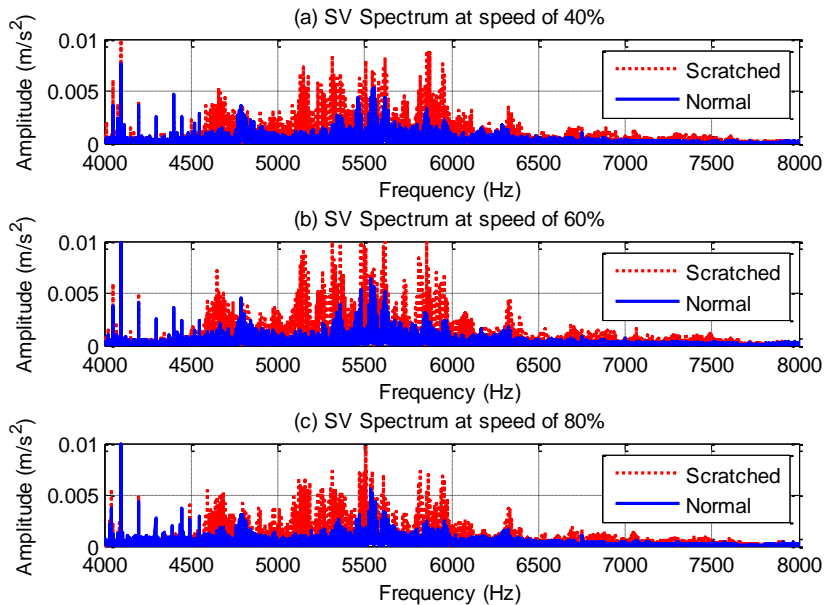

Figure 6. SV spectrum comparisons between normal and scratching fault.

It can be seen that there is a significant difference in amplitude of normal and scratching bearing. The surface vibration amplitude occur from 4250Hz to 8000Hz, but the higher amplitude is seen around a frequency of 5500Hz. This amplitude originates from frictional problems generated by scratching surface bearing.

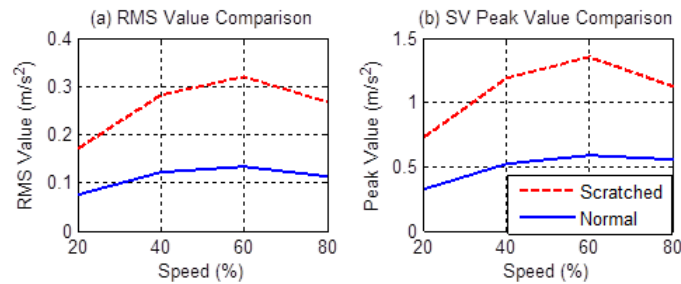

Figure 7. SV RMS and Peak value comparison between normal and seeded scratching fault.

Figure 7 depicts the surface vibration waveform statistic parameters of scratched and normal bearing. It consists of RMS value and peak value due to variation in speed. The figure shows that RMS of SV value of scratching bearing is greater than RMS value of normal bearing. The Peak value indicates similar phenomenon to RMS value.

4.2. Airborne sound measurement result

The airborne-sound characteristic of self-aligning spherical journal bearing with scratching fault was conducted under constant torsion load 10%, 45.3N radial load and at speed variable 20%, 40%, 60%, and 80% speed. The bearing was lubricated with specified lubricant ISO VG 46. The microphones were placed 200 mm from bearing housing.

Time-domain, frequency-domain and load correlation were used. In the time-domain, RMS value and peak value of the signal were used to evaluate the airborne sound signal. In the airborne sound frequency-domain, descriptive and comparative analysis was also used. Figure 8 shows the result of airborne sound signal measurement on the journal bearing using normal condition and scratching conditions which were operated under a torsion load of 10% and at speed of 80%. It can be seen that the difference of signal amplitude of scratching and normal journal bearing are relatively small at time domain. To determine the frequency at which the amplitude change is significant, further analysis was carried out at frequency domain and is shown in Figure 9.

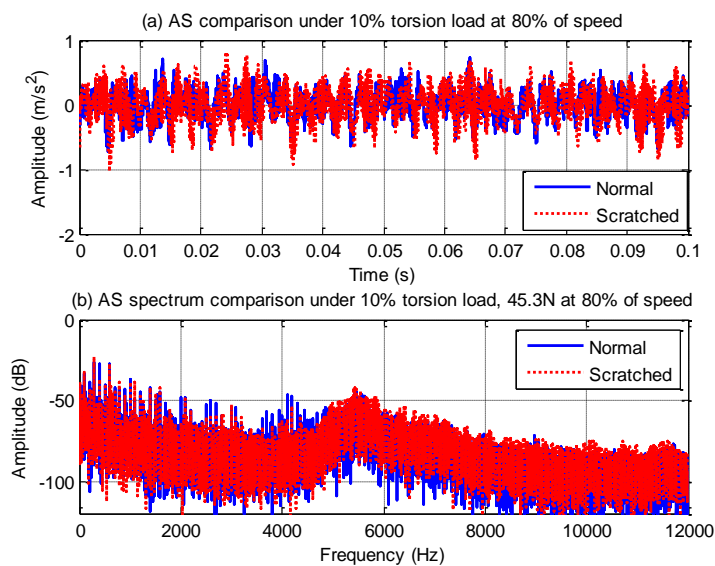

Figure 8. AS signal comparison between normal and scratching fault at 80% speed.

Figure 9 represents the airborne sound spectrum in frequency domain obtained information that a significant amplitude difference lies at the frequency of 5500Hz, also airborne sound occurs at a wide range of frequency between 4250Hz to 7750Hz. This amplitude also originates from scratching problems.

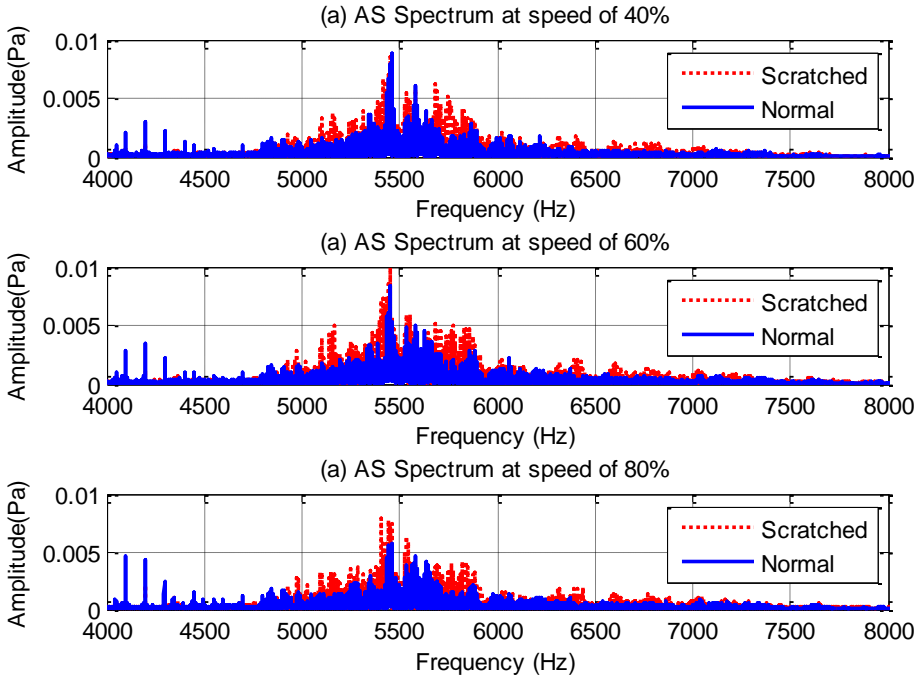

Figure 9. Airborne Sound spectrum comparisons between normal and scratching fault.

Figure 10 is a waveform statistics parameter analysis under different speeds. The figure explains that the airborne sound RMS value and peak value on the scratching bearing is always higher than normal bearing at different speeds. The result also indicates that when speed increases the RMS and Peak value also increases.

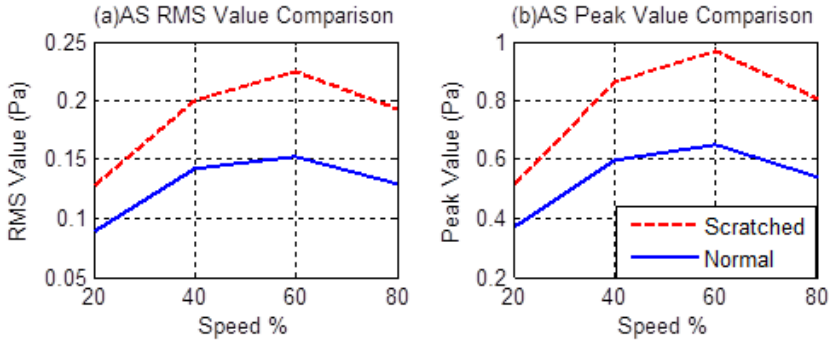

Figure 10. AS RMS and Peak value comparison between normal and scratching bearing

4.3. Acoustic emission measurement result

The acoustic emission characteristic of self aligning spherical journal bearing with scratching fault investigation was conducted under constant torsion load 10% of the maximum value, 45.3N radial load and at speed variable 20, 40, 60, and 80% speed. The bearing was lubricated with specified lubricant ISO VG 46.

In this experiment Figure 11 represents the comparison AE signal response between scratching and normal bearing in time-domain under 10% torsion load, 45.3N radial load at 80% speed. The figure indicates that there is a clear difference between AE signal in time domain between scratching and normal bearing.

In the statistic parameter analysis, RMS value and peak value of the signal were used to evaluate correlation of speed and amplitude. In the frequency-domain, descriptive and comparative analysis was also used.

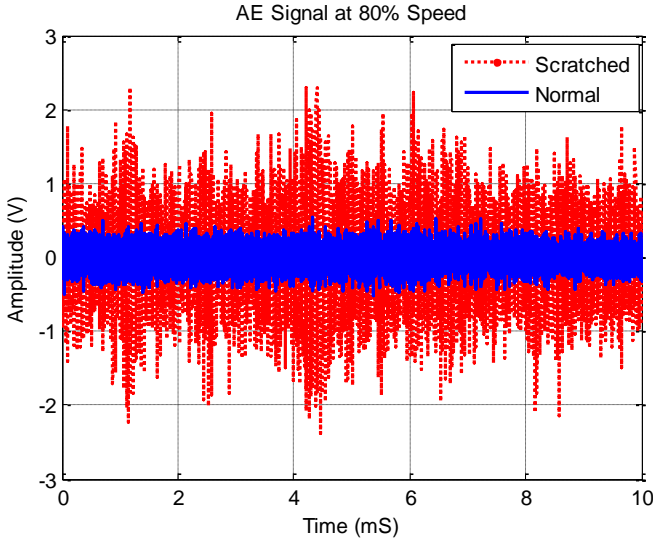

Figure 11. AE Signal comparisons between normal and scratching fault.

Figure 11 shows AE signal comparison between normal and scratching fault. It can be seen that amplitude difference of normal and scratching bearing faults are significant.

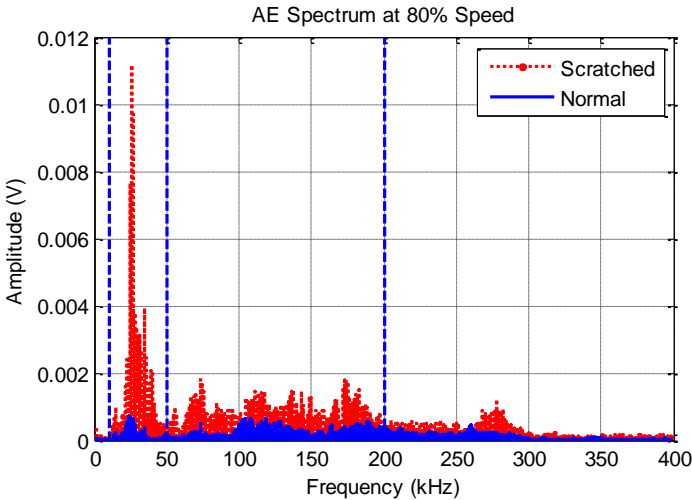

Figure 12. AE Spectrum comparisons between normal and scratching fault.

Figure 12 shows AE Spectrum comparison between normal and scratching fault at a speed of 80% in frequency domain. It can be seen clearly that the normal and scratched bearing resulted in a significant difference. In addition, the pattern form AE spectrum shows high amplitude occurs at frequency between 10 kHz to 50 kHz followed at 50 kHz to 200 kHz and finally followed at frequency greater than 200 kHz. While the high amplitude of spectrum concentrate at frequency 25 kHz. The amplitude of AE spectrum is higher than normal bearing at any frequency. The effect of speed to AE RMS value and Peak value on healthy and scratching journal bearing can be seen in Figure 13.

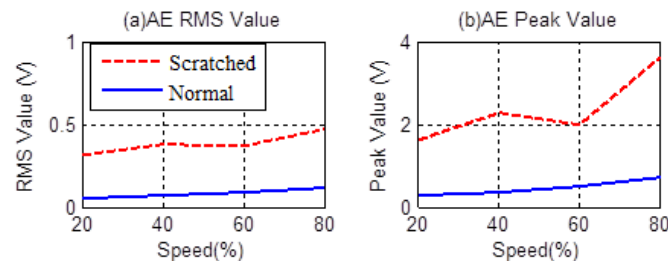

Figure 13. AE RMS and Peak value comparison between normal and scratching bearing.

The figure depicts that the RMS, AE value and AE Peak value on scratching bearing is higher than healthy bearing and there is positive correlation between speed RMS and Peak value

5. Conclusion

This paper focused on the comparison of detection performance between SV, AS and AE measurements from a self aligning spherical journal bearing under healthy and internal surface scratching marks. From the investigation, the following conclusions can be drawn:

1. The differences of three signals are quite significant between the healthy and faulty conditions in the high frequency range, which are mainly due to the mixing lubrication process caused by the scratching. The difference in the low frequency range was observed due to rotor dynamics.
2. The surface vibration amplitude occurs in a frequency range from 4250Hz to 8000Hz due to scratching. The highest amplitude is seen at frequency of 5500Hz.
3. The RMS of surface vibration for scratching increases with shaft speeds but remains higher than that of a healthy case, which shows that the vibration responses are well correlated to asperity contact characteristics.
4. The airborne sound amplitude due to scratching appears at frequency between 4250Hz to 7750Hz and high amplitude lie in the frequency 5500Hz.
5. The pattern form AE spectrum shows high amplitude occur at frequency between 10 kHz to 50 kHz followed by at 50 kHz to 200 kHz
6. The increasing of speed influence the rising of the RMS and Peak value of SV, AS and AE spectrum.
7. The SV, AS and AE monitoring methods can be used for determining bearing conditions. The AE monitoring method is more sensitive for scratching bearing fault.

References

- [1] Arvis 2009 *Arvis Bearings*, Catalogue, Criptic Arvis Ltd Croft Grange Works 16 Bridge Park Road Thurmaston LE4 8BL Leicester UK
- [2] Schoen R R, Habetler T G, Kamran F and Bartheld R.G 1995 *Motor bearing damage detection using stator current monitoring* IEEE Trans. On Industry Application Vol. **31** No. 6 pp. 1274-9
- [3] Sin M L, Soong W L and Ertugrul N 2003 *Induction machine on-line condition monitoring and fault diagnosis, a survey* University of Adelaide

- [4] Clevite 2002 *Engine Bearing Failure Analysis Guide, A guide to analysis and correction of premature engine bearing failure* Clevite 77 Issue Form CL77-3-402
- [5] Kreith F 1998 *The CRC Handbook of Mechanical Engineering* CRC Press Inc. USA.
- [6] Scott R 2008 *Basic wear modes in lubricated systems*. Machinery Lubrication Noria Publication No. **1375**
- [7] Poley J 2007 *The History of Oil Analysis, Machinery Lubrication* Noria Publication No. **1113**
- [8] Roylance B J 2003 *Machine failure and its avoidance-what is tribology's contribution to effective maintenance of critical machinery?* Proc IMechE Volume **217** Part J Engineering Tribology J05302
- [9] Gribble J 2006 *Acoustic analysis for the rest of us* Machinery Lubrication Noria Publication No. **839**
- [10] Ohtsu M 2000 *Moment tensor analysis of AE and sigma code Acoustic Emission Beyond Millennium* Elsevier Tokyo, Japan
- [11] De Silva C W 2007 *Vibration, fundamentals and practice* Second Edition Taylor and Francis CRC Press USA.
- [12] Tucan D 2009 *Multi parameter vibration analysis of various defective stages of mechanical components* SKF Reliability System.
- [13] Dickerhof M, Albers A, Burger W and Sovino R. 2006 *Monitoring Lubrication Regimes in Sliding Bearings – Using Acoustic Emission Analysis* Practicing Oil Analysis May Noria Publication
- [14] Choudhury A and Tandon N 2000 *Application of acoustic technique for detection of defect in rolling element bearing* Tribology International **33** pp. 39-45
- [15] Kolubaev E, Kolubaev A and Sizova O 2010 *Analysis of Acoustic Emission during Sliding Friction of Manganese Steel* Pleiades Publishing Ltd. ISSN 1063-7850 Technical Physics Letters No. **8** pp. 762-765
- [16] Bonnes R and McBride S 1991 *Adhesive and abrasive wear studies using acoustic emission techniques* Wear Volume **149** Issues 1-2 pp. 41-53
- [17] Ali M and Mba D 2008 *Observation of Acoustic Emission in A Hydrodynamic Bearing*, The 2nd International Conference on Technical Inspection and TINDT October Teheran Iran.
- [18] Barron F 2001 *Industrial Noise Control and Acoustic* Marcel Dekker Inc New York.
- [19] Kim M, Jang G, Lee C and Lim D 2010 *Experimental identification of abnormal noise and vibration in a high speed polygon mirror scanner motor due to mechanical contact of plain journal bearing*, Springer Verlag Microsystem Technology **16** pp.3-8
- [20] Rorrer R and Juneja V 2002 *Friction-induced vibration and noise generation of instrument panel material pairs* Elsevier Tribology International No. **35** pp. 523-531