



University of HUDDERSFIELD

University of Huddersfield Repository

Fazenda, Bruno

Perception of room modes in critical listening spaces

Original Citation

Fazenda, Bruno (2004) Perception of room modes in critical listening spaces. Doctoral thesis, University of Salford.

This version is available at <http://eprints.hud.ac.uk/id/eprint/3601/>

The University Repository is a digital collection of the research output of the University, available on Open Access. Copyright and Moral Rights for the items on this site are retained by the individual author and/or other copyright owners. Users may access full items free of charge; copies of full text items generally can be reproduced, displayed or performed and given to third parties in any format or medium for personal research or study, educational or not-for-profit purposes without prior permission or charge, provided:

- The authors, title and full bibliographic details is credited in any copy;
- A hyperlink and/or URL is included for the original metadata page; and
- The content is not changed in any way.

For more information, including our policy and submission procedure, please contact the Repository Team at: E.mailbox@hud.ac.uk.

<http://eprints.hud.ac.uk/>

**PERCEPTION OF ROOM MODES IN
CRITICAL LISTENING SPACES**

Bruno Fazenda

Research Institute for the Built and Human Environment

University of Salford, Salford, UK

**Submitted in Partial Fulfilment of the Requirements of the
Degree of Doctor of Philosophy, August 2004**

List of Figures and Tables	vi
Figures.....	vi
Tables	ix
Acknowledgements.....	x
Abstract.....	xii
1 Introduction.....	1
1.1 Introduction.....	1
1.2 Critical listening rooms.....	1
1.3 Research problem – room modes.....	2
1.4 Research aim and objectives.....	3
1.5 Methodology.....	3
1.5.1 Scope.....	3
1.5.2 Qualitative study.....	4
1.5.3 Subjective tests.....	4
1.5.4 Headphone reproduction and models of real conditions.....	4
1.6 Contributions and main findings.....	5
1.7 Thesis structure.....	6
2 Literature Review.....	9
2.1 Introduction.....	9
2.2 Modal theory.....	10
2.3 Modal control.....	11
2.4 Subjective perception of resonances.....	19
2.5 Summary.....	23
3 Sound Fields in Enclosed Spaces	25
3.1 Introduction.....	25
3.2 Rectangular room with hard walls – modal theory.....	25
3.2.1 No source.....	29
3.2.2 Source excitation.....	30
3.2.2.1 Point source.....	31
3.2.2.2 Rectangular piston.....	35
3.3 Summary.....	39
4 Preferences and Views of Control Room Users – a Qualitative Study.....	41
4.1 Introduction.....	41

4.2	Research technique.....	41
4.3	Analysis and discussion	42
4.4	Summary	45
5	Control of Room Modes	48
5.1	Introduction.....	48
5.2	Resonant membrane absorbers.....	51
5.2.1	Case study 1 – Low frequency absorption in a studio control room.....	53
5.2.2	Case study 2 – Correction of a listening room.....	56
5.2.3	Performance of membrane absorbers.....	58
5.3	Rationale for the use of DML to excite low frequencies	62
5.3.1	Prediction models for distributed sources in rooms.....	66
5.3.1.1	Classical plate theory review	66
5.3.1.2	Analytical model for simply supported plate in room	69
5.3.1.3	Superposition model	70
5.3.2	Applications to low frequency room excitation.....	72
5.4	Summary	83
6	Subjective Perception of Modal Distribution – Dependence on Room Aspect Ratios.....	85
6.1	Introduction.....	85
6.2	Modal density and distribution.....	85
6.3	Metrics	86
6.4	Binaural model of a listening space	92
6.4.1	High frequency binaural impulse responses	93
6.4.2	Low frequency model	94
6.4.3	Audition samples.....	95
6.4.4	Headphone reproduction	95
6.5	Test method.....	96
6.6	Results and discussion	98
6.6.1	Test A - Two metrics, three music styles.....	98
6.6.2	Test B - Effect of key transposition	102
6.7	Summary	107
7	Effects of Resonances on Single Tones.....	108
7.1	Introduction.....	108
7.2	Low frequency resonances.....	109
7.3	Temporal aspects of input stimuli.....	113

7.3.1	System response to long stimulus	116
7.3.2	System response to transient stimulus	123
7.3.3	Discussion for the temporal effects of input stimulus.....	132
7.4	Subjective perception tests.....	133
7.5	Results and discussion	134
7.5.1	Effects of temporal structure of stimulus.....	134
7.5.2	Effects of resonant response.....	137
7.5.3	Effects of Q-factor of resonances.....	138
7.5.4	Discussion of results	138
7.6	Summary	140
8	Difference Limen for Q-factor of Room Modes	141
8.1	Introduction.....	141
8.2	Binaural model of a listening space	142
8.2.1	Low frequency room model.....	143
8.2.2	Forming a model room.....	144
8.3	Test method.....	146
8.4	Results and discussion	147
8.5	Summary	158
9	Conclusions	159
9.1	Introduction.....	159
9.2	Results from a qualitative study into the views and preferences of control room users	159
9.3	An investigation into modal control techniques.....	160
9.3.1	Modular resonant membrane absorbers	160
9.3.2	The distributed mode loudspeaker as a low frequency radiator.....	161
9.4	Subjective perception of room modes.....	162
9.4.1	Results for the perception of modal distribution.....	163
9.4.2	Results for the effects of resonances in single tones and the importance of temporal information	163
9.4.3	Results for a difference limen for the Q-factor of room modes.....	165
9.5	Implications to room design.....	167
9.6	Further work.....	169
9.6.1	Linear relationship of difference limen for Q-factor.....	169
9.6.2	Difference limen for Q-factor depending on frequency.....	170
9.6.3	Comparison of modal equalisation methods.....	171

9.6.4	Difference limen for decay rates of single modes.....	172
9.6.5	Quality rating of modal distribution.....	173
Appendix I	Qualitative Study.....	175
Appendix I.i	Survey Questionnaire.....	176
Appendix I.ii	Interview Structure.....	177
Appendix I.iii	Interview transcription.....	178
Appendix II	Room measurements.....	185
Appendix II.i	Steady state modal sound field.....	185
Appendix II.ii	Reverberation time.....	185
Appendix III	Distributed Source Derivations.....	187
Appendix III.i	Derivation for source shape function for a rectangular piston – front radiation only	187
Appendix III.ii	Coefficients in frequency equation for distributed plates.....	190
Appendix III.iii	Derivation for source shape function for a simply supported plate – front radiation only.....	191
Appendix IV	Statistics.....	196
Appendix IV.i	Null hypothesis and significant levels.....	196
Appendix IV.ii	Chi-Square tests.....	197
Appendix IV.iii	Normal distribution.....	197
Appendix IV.iv	Parametric and non-parametric analysis of variance.....	200
Appendix V.	List of References.....	206

List of Figures and Tables

Figures

Figure 3.1 – Measured and predicted magnitude frequency responses for an ideal point source in a room. Measurement using a large 0.05 m ² cone loudspeaker.	34
Figure 3.2 – Definition of the coordinate system for a rectangular piston in a room. The coordinate x_0 is magnified for illustrative purposes. In the modelled situations $x_0=0$	36
Figure 3.3 – Magnitude frequency room response in the room. Comparison of measured data with a closed box loudspeaker to predicted values for a rectangular piston of the same area.	37
Figure 3.4 – Convergence with distance for modelled point and rectangular piston source. For very small distances the results for point source (solid red line) converge to free field radiation (dot dash line). A large rectangular piston (solid blue line) still produces large amplitude variations, whilst a small piston (dashed blue line) has similar characteristics to a point source.....	38
Figure 5.1 – Cut view of a membrane resonant absorber with thin plywood membrane.	51
Figure 5.2 – Modal Response of Control Room. Measured room responses are shown before (- -) and after (-) low frequency treatment with resonant membrane modules. Room eigenfrequencies are indicated in dots.....	54
Figure 5.4 – Reverberation time measured in the control room before and after the introduction of low frequency control modules.	55
Figure 5.6 – Magnitude frequency response of a listening room before and after low frequency control.	57
Figure 5.7 – Reverberation time for listening room measure before and after low frequency treatment. ...	58
Figure 5.6 – DML in position 1.....	64
Figure 5.7 – DML in position 2.....	64
Figure 5.10 – Modal frequency response for point source and distributed mode loudspeaker in a 1:5 scale room. Numbers indicate the modal order in each of the room dimensions (x-length, y—width, z-height). Two DML positions are shown.	65
Figure 5.9 – Comparison between analytical and numerical based prediction models for a simply supported plate in a rectangular room.....	71
Figure 5.10 – Modal response of a rectangular duct using distributed mode plates. Results are compared to excitation from a large rectangular piston shown in the solid black line. All plates are positioned at one end of the duct.....	73
Figure 5.11 – Plate defined as one surface of the duct.	74
Figure 5.12 - Modal response of a rectangular duct using distributed mode plates. Results are compared to excitation from a large rectangular piston shown in the solid black line. All plates are positioned along the longest dimension of the duct	74
Figure 5.13 - Modal response of a rectangular duct excited by a simply supported plate. Results are compared to point source excitation shown in dashed line. Two plate situations are shown, with modal matching at second and third modes on the plate.	76
Figure 5.14 – Variation of pressure in a rectangular duct predicted at the first axial mode (72 Hz). The top plot shows the response to point source excitation. Bottom plot shows the response to simply supported plate with the 3rd eigenfrequency of the plate matching the first axial room mode.	78
Figure 5.15 – Comparison of modal sound field in a rectangular room for point source defined at one corner and simply supported plate defined to cover one wall. Two plate damping settings are shown. Response position is defined at opposite corner.....	80
Figure 5.16 – Impulse response for model of real size room when using a simply supported plate as a source. Two plate damping cases are shown.	82
Figure 6.1 – Performance for two rooms on Metric 1 based on pressure distribution.	87

Figure 6.2 - Performance for two rooms on Metric 2 based on modal spacing.....	89
Figure 6.3 - Comparison of the two metrics under study.....	90
Figure 6.4 – Magnitude pressure response for room 1.....	91
Figure 6.5 – Schematic for the generation of audition samples.....	93
Figure 6.6 – Calibration of prediction model output levels, adjusted to similar conditions in the real room.	95
Figure 6.7 – Frequency response of Sennheiser HD600 headphones measured on B&K type 4128c Head and Torso simulator.....	96
Figure 6.8 – ABX test software interface. www.pcabx.com	97
Figure 6.9 – Results for Test A. Correct answers for each music style and according to the two contrasts tested.....	99
Figure 6.10 – Results for test A averaged across music style.....	100
Figure 6.11 – Interaction between room response and power spectra of one note present in the input signal. A bass note is shown as original and transposed upwards in frequency.....	103
Figure 6.12 – Results for test B. Correct answers for each frequency content and according to the two contrasts tested.....	104
Figure 7.1 – Magnitude and phase response for a resonant system with centre frequency 80 Hz and Q- factor of 20. Modelled using a single bi-quad pole/zero configuration.....	111
Figure 7.3 – Impulse response of resonant system with one single resonance of 80 Hz and Q-factor 20.....	111
Figure 7.5 – Pole/Zero plot for a bi-quad IIR filter with centre frequency 80 Hz and Q-factor of 20. Sampling frequency is 800 Hz.....	112
Figure 7.7 – Three resonant conditions commonly found in rooms at the frequency of excitation.....	113
Figure 7.8 – System input signal modelled as various cycles of a single tone of frequency 80 Hz and with a smooth amplitude envelope. The amplitude envelope is a Tukey window with a tapered to non- tapered ratio of 1.....	115
Figure 7.9 – Power spectra for a smoothly varying sine burst centred at 80 Hz. Response obtained by Fourier transforming the time domain input.....	116
Figure 7.10 – Output response of a single resonance at 80 Hz when subjected to a smoothly varying 80 Hz sine burst.....	117
Figure 7.12 – Output power spectra for a single 80 Hz resonance when subjected to a smoothly varying 80 Hz sine burst.....	118
Figure 7.14 - Output response of resonant system comprised of two components at 70 Hz and 90 Hz when subjected to a smoothly varying 80 Hz sine burst.....	118
Figure 7.16 - Output power spectra for two resonances at 70 Hz and 90 Hz when subjected to a smoothly varying 80 Hz sine burst.....	119
Figure 7.17 – Output power spectral decay for a dual resonant system with long input at 80 Hz. The forced response is dominated by the input stimulus, whilst the natural response shows evidence of the two resonant components.....	120
Figure 7.18 - Output response of an anti-resonance at 80 Hz when subjected to a smoothly varying 80 Hz sine burst.....	121
Figure 7.19 - Output power spectra for an anti-resonance at 80 Hz when subjected to a smoothly varying 80 Hz sine burst.....	122
Figure 7.20 - Output power spectral decay for an anti-resonant system with long input at 80 Hz. The forced response is dominated by the input stimulus, whilst the natural response shows evidence of the two resonant components.....	122
Figure 7.21 – Time representation of a single frequency transient tone (80 Hz) with fast onset. This waveform is representative of a ‘plucked’ string instrument such as a bass guitar.....	123
Figure 7.22 – Power spectra for transient input signal. The wideband levels are evident. This increase in wideband energy is associated with the transient behaviour of the signal.....	124

Figure 7.23 – Pressure response output of a single resonant system with matching stimulus and resonant frequencies (80 Hz). Stimulus is modelled as a transient tone.	125
Figure 7.24 – Output power spectra for a single resonant system with matching stimulus and resonant frequencies (80 Hz). There is no evidence of the introduction of extra spectral components.	126
Figure 7.25 – Output pressure response for a dual resonant system with a transient stimulus. The response shows a slower onset time and amplitude fluctuations due to the interaction between the spectral components of the system. There is evidence of a decay longer than the original input stimulus..	127
Figure 7.26 – Output power spectra for a dual resonant system with a transient single frequency input. The two resonances appear as spectral content approximately 15 dB below the input spectral component.	127
Figure 7.27 – Output spectral decay for a dual resonant system with a transient single tone input. There is evidence of the two resonant spectral components at the onset and natural responses of the system.	128
Figure 7.28 – Output pressure response for an anti-resonance with a transient single tone input. The response shows a fast onset time and amplitude fluctuations caused by the interaction between the spectral components of the system.	129
Figure 7.29 - Output power spectra for an anti-resonance with a transient stimulus. The two resonances that form the anti-resonance appear as high-level spectral content on each side of the input stimulus.	130
Figure 7.30 - Output spectral decay for an anti-resonant system with a transient single tone input. There is evidence of the two high level resonant spectral components at the onset and natural responses of the system.	131
Figure 7.31 – Results for detection of differences grouped according to stimulus duration.	135
Figure 7.32 – Results for the detection of resonances on a single tone.	136
Figure 8.1 - Frequency response for two Q-factor cases of the modal response obtained using parallel addition of bi-quad IIR filters.	144
Figure 8.2 – PEST convergence results for one subject in all tested cases; a) Low RT, b) High RT.	147
Figure 8.3 – Results for the difference limen for the Q-factor of room modes.	151
Figure 8.4 – Data representing a generic difference limen for the Q-factor of room modes. Experimental data contrasted with a regression analysis prediction.	153
Figure 8.5 – Equivalent decay rates for the experimental Q-factor difference limen. The decay rates are calculated for each octave band centre frequency of the lower auditory range.	155

Tables

Table 5.1 – Obtained values for CHANGES in RT and Q-Factor, according to measurements BEFORE and AFTER low frequency control. Alterations to the decay values have been converted to Q-factor values in order to evaluate the subjective perception of changes, according to new difference limen defined in Chapter 8.	60
Table 5.2 – Difference limen for the Q-factor of room modes for each Q-factor target value.....	61
Table 5.3 – Decay times in seconds for the sound field in a duct when excited by two different simply supported plate configurations. The eigenfrequencies on the plate are adjusted so that a specific match is obtained with the frequency of the first room mode. Mode 3 corresponds to the third eigenfrequency of the plate matching the first room mode. Mode 2 corresponds to the second plate eigenfrequency matching the first room mode. Results are contrasted to point source excitation. ..	79
Table 5.4 – Corresponding decay times, in seconds, for a prediction model of a real size room. Two different simply supported plate cases are contrasted with point source. The effects of plate damping on the low frequency decay are shown.	81
Table 6.1 – Room ratios under study and corresponding score on each of the metrics. Metric 1 has values for standard deviation from a constant pressure level. Metric 2 has values for standard deviation to ‘desired’ modal distribution as defined by Bolt (1939).	91
Table 6.2 – Chi-square test results for rate of detection for each experimental case.	99
Table 6.3 – Non-parametric analysis of variance for test A on the detection of changes in modal distribution. The effects of the factors Music Style and Contrast are determined.	100
Table 6.4 – Chi-square test results for rate of detection – test B.....	105
Table 6.5 – Test B - Analysis of variance for effects of transposition and contrast.....	105
Table 7.1 – Chi Square test for each experimental case. Low values of p ($p < 0.05$) indicate statistical support that the results obtained are significant.....	136
Table 7.2 – Results for the effects of Q-factor on the detection of resonances.	138
Table 8.1 – Centre frequencies and gain for the modes included in the model. These settings were taken from measurements of a real room.	145
Table 8.2– ANOVA including three factors; RUN, RT and Q.	148
Table 8.3– ANOVA results performed on each of the three runs individually.	148
Table 8.4– Statistical factors for the analysis of variance.	149
Table 8.5 - ANOVA for Run number 3.....	150
Table 8.6– Difference Limen for Q-factor in room modes.	150
Table 8.7– Average values for Q-factor difference limen at two RT cases.	151
Table 8.8– Average values for Q-factor difference limen at three reference Q cases.	152
Table 8.9 –Tests for Linear Trends in experimental data.....	152
Table 8.10- Decay rates (in seconds) for experimental difference limen of Q-factor. Reference Q value for each case is indicated.....	155
Table 8.11 – Equivalent Rectangular Bandwidth of auditory filter and corresponding Q-factor and decay vales for low frequency octave bands.....	156
Table 9.1 – Average values for the difference limen of Q-factor in room modes.....	165

Acknowledgements

I am thankful to the Portuguese Ministry of Science and Education – Fundação Para a Ciência e a Tecnologia (PRAXIS XXI), and to the Marie Curie fellowships (EDSVS) for their financial support.

I would also like to gratefully acknowledge the support of many people whose help has been precious in many ways.

All those who participated in the interviews and experiments, for their valuable contributions.

All the staff and research members from the Acoustic Departments at the University of Salford and the Technical University of Denmark, for their indispensable support.

Dr. Finn Jacobsen for his critical observations and meaningful discussions, which helped the clarification of many important issues.

Special appreciation is owed to the research supervisors, Dr. William Davies for his guidance and encouragement, and Dr. Mark Avis for his unconditional support, inspiration and ‘omniscience’.

Finally, I express my grateful admiration to all close to me whose true friendship and love were never dwindled by distance.

Financial Support:

Fundação para a Ciência e a Tecnologia (Programa Praxis XXI): January 2000-December 2003

Marie Curie Fellowships (European Doctorate for Sound and Vibration Studies): February 2004-July2004

To my parents

Abstract

Room modes are a recognised problem in small critical listening rooms and are known to cause colouration of sound reproduced within them.

Investigations on the causes and solutions for this problem have been carried out for some time. Interest in the topic has extended to loudspeaker manufacturers who have mainly concentrated in developing methods for controlling the loudspeaker-room interaction in order to ameliorate low frequency reproduction.

Compared to objective work on passive and active control methods, the study of the subjective perception of room resonances has been somewhat neglected. Available publications mostly concern the effects of single resonances, which are perhaps not fully representative of conditions as experienced in real rooms.

A study into the subjective perception of room modes is presented. The experimental methodology employs psychoacoustic techniques to study the perception of factors such as modal distribution, and effects of resonances on single tones. Results show that the subjective perception of room modes is strongly affected by temporal issues, and that changes exerted merely on magnitude frequency response are detectable but not likely to remove the effects of resonances for all listeners.

Furthermore, it is shown that a reduction of the modal Q-factor, associated with a reduction of decay rates, has a significant effect in decreasing the detection of resonances. Q-factor difference limen were evaluated for three reference decay characteristics corresponding to reference Q-factors of 30, 10 and 1. The limen were 6 ± 2.8 , 10 ± 4.1 and 16 ± 5.4 respectively, meaning that detection of changes to modal decay decreases with decreasing decay time.

These results may be used to define more perceptually relevant design guidelines for critical listening environments, and indicate target criteria for control techniques used in room correction. The outcomes of this investigation will have repercussions on the design of better rooms for critical listening.

1 Introduction

1.1 Introduction

This chapter presents the introduction to the thesis. The main area of research is established with particular attention to the specific topic within this area. The research problem is then identified together with the acknowledgement of a gap in current knowledge. The research focus and aim are indicated, and the main objectives to be fulfilled in order to achieve this aim are listed. A short section describes the contributions to the field and their importance to the current academic and industrial fields. The proposed solutions for the research problem and the methodological approach adopted are set-up and explained. Finally, the thesis structure is described informing the reader where to find relevant information throughout the document.

1.2 Critical listening rooms

A critical listening room is a space used for tasks that require the monitoring of reproduced sound in a comfortable and correct manner. The definition of *correct* is in itself a difficult concept to assert, as, in this case, it is dependent on subjective aspects of human perception of sound. Indeed, this conceptual difficulty has always been inherent in fields of acoustic science that study objectively measurable conditions and attempt to link them to subjective perception. This is usually achieved by psychoacoustic testing that establishes links between the two fields. This investigation aims to provide one such link in the field of small room acoustics.

In the last decades, the design of rooms for critical listening has gained increasing interest as investigators and designers have strived to identify and achieve conditions where the sound was reproduced without the distracting effects of the room environment (Voelker 1985 a; Toyoshima et al. 1993; Newell 1995; Newell and Holland 1997).

With the growing importance of the rooms where music was being reproduced, many design philosophies have emerged (Davis and Davis 1980; Toyoshima et al. 1993; Newell et al. 1994; Angus 1996). These have often been based on underlying psychoacoustic assumptions, for example the effects of reflections on the perception of stereo (e.g. Wrightson 1986; Voelker 1998 b). In order to progress towards standard monitoring conditions and ensure that these are free from undesired problems, recommendations for the design of rooms for audio reproduction have been published (e.g. IEC 268-13 1985; BS 6840-Part13 1987).

The usual acoustic ‘tools’ available (absorption, redirection and diffusion) have been sufficient to address factors within critical listening rooms, such as reverberation time and first reflections.

However, other problems, such as room modes, have proven difficult to control using standard solutions. The research presented in this thesis is concerned with the latter – low frequency reproduction and perception in small rooms.

1.3 Research problem – room modes

One common characteristic of critical listening rooms is their small volume, usually below 200 m³. As a consequence, these rooms exhibit resonances, commonly known as room modes, which are sparsely distributed in the lower audible frequencies and cause large amplitude variations at specific frequencies and long decays of sound in this range. This causes the reproduction of sound in the room to be altered in such a way that accurate transmission from source to receiver is no longer possible (e.g. Kuttruff 2000). The repercussions of this are important, as they hinder the performance of users of such rooms. Typical performance tasks involve critical and prompt evaluation of complex auditory stimuli, and affect the quality of the work carried out in these rooms, which will ultimately determine the quality of the commercial audio media produced in them.

The issue of room modes has been researched for many decades (e.g. Bolt 1939 c; Louden 1971), and in more recent years, room designers and loudspeaker manufacturers have dedicated a good deal of research into its amelioration (e.g. Farnsworth et al. 1985; Makivirta et al. 2003). The solutions proposed have been widely varied, ranging from the use of room aspect ratios (e.g. Louden 1971; Bonello 1981), through to passive absorption (e.g. Newell et al. 1997; Fuchs et al. 2000) and more sophisticated techniques based on active control (e.g. Makivirta et al. 2003). This extensive scientific and industrial interest certainly indicates the central importance of such a problem.

All modal control techniques concentrate on the removal or reduction of objective factors associated with room modes. These techniques may address the modal distribution, the frequency response or the decay of sound in the room. Hitherto, these control techniques have been based on a few psychoacoustic studies carried on the subjective perception of resonances (Fryer 1975; Bucklein 1981; Olive et al. 1997), which have been somewhat specific to the detection of isolated resonances and consequently distanced from conditions commonly found in rooms. Frequently, authors publishing promising studies on control regimes express the requirement for more dedicated knowledge on the perception of room modes that could guide the selection of control targets and suggest subjectively accurate reproduction conditions (e.g. Makivirta 2003, Antsalò 2003).

It follows that important links between objective descriptors of low frequency room conditions (modal distribution, decay time, magnitude frequency response, etc) and their respective

percepts are still largely unknown or are described anecdotally. This shortage of specific studies on the perception of room modes in critical listening rooms has been identified as a gap in the current knowledge, which in turn prevents the definition of perceptually accurate listening conditions and has led to a great deal of confusion between the subjective efficacy of low frequency control techniques based on different principles (e.g. Antsalo 2003). In response to this, this dedicated study into the perception of room modes provides scientific evidence of the subjective factors that affect their perception with the intention that this knowledge will then be used in the prescription of more accurate listening conditions and as a guide in the design of perceptually efficient control methods.

1.4 Research aim and objectives

The aim of this investigation is to provide further knowledge on the subjective perception of room modes in the specific context of small critical listening spaces.

In order to achieve this aim, a set of objectives has been determined. The objectives for this investigation are:

- To capture the degree of anecdotal and experiential evidence amongst professional users concerning the extent of the problem of room modes in critical listening.
- To identify the perceptibility of factors, such as modal distribution, Q-factor and decay time, associated with modes in small rooms.
- To determine the importance and relevance of each factor as perceived by critical listening room users.
- To determine the difference limen¹ of subjectively important factors in order to provide control targets and aid in the subjective evaluation of control techniques.

1.5 Methodology

1.5.1 Scope

This research concerns the perception of reproduced sound at low frequencies in audio control rooms, with volumes under 200 m³. This type of room has been selected because it is where the problems of room modes may have most significant repercussions on the quality of sound being monitored. Wherever possible, the investigation is conducted in such a way that its results may

¹ Minimum noticeable difference.

be generalised to other listening environments or areas concerned with low frequency reproduction.

This thesis does not intend to present a study on control methods, as this is an area where much research has already been carried out. However, such work is highly relevant to this study, and various references may be found throughout the text to provide the reader with a context for the application of the perceptual investigations reported herein.

1.5.2 Qualitative study

The rationale for the investigation presented is based not only on the research devoted to the problem of room modes, but also on a qualitative study carried out to identify main problems in current state of the art control rooms. Low frequency reproduction is pointed out in this study as one of the most common problems perceived in control rooms and affecting users' performance. This provides empirical evidence for the occurrence of this problem in current state-of-the-art facilities and justifies the allocation of time and resources for the investigation.

1.5.3 Subjective tests

A quantitative research technique was used to identify the psychoacoustic effects affecting low frequency reproduction in rooms. More precisely, techniques for the absolute detection of differences as well as the determination of difference limen have been employed. These techniques have taken the form of *ABX* and *two-interval-forced-choice* testing. These are common psychoacoustic methods used to extract data from a group of subjects and are introduced in the chapters where they are used. The detection of an effect is obtained by applying systematic changes to the factor under study whilst controlling, as much as possible, all other confounding factors within the experimental context. Appropriate statistical analysis is then applied to identify trends in results and their scientific significance.

1.5.4 Headphone reproduction and models of real conditions

It was decided to employ experimental techniques that use headphone reproduction to present binaural acoustic stimuli to the subjects. This is obtained by the use of impulse responses recorded in real environments complemented by analytical models of low frequency sound fields. This experimental technique is common for all subjective tests presented in this thesis, and the process of creation for the audition samples is described in detail in section 6.4. The specific variations introduced to this process for each test are described in the relevant chapters.

This technique enables the audition of different experimental conditions sequentially. This avoids common problems experienced in tests which employ physical environments, related to poor acoustic memory and the long pauses needed to physically change acoustic conditions (Niaounakis and Davies 2002). Furthermore, the chosen method allows the modelling of low frequency sound fields that would be problematical to obtain in reality, and allows the independent variation of test dimensions for experimental purposes, which might not be physically orthogonal.

Where possible, it was decided to use real musical signals as opposed to test tones, although these are also used in one of the subjective tests presented. The choice of using commercially recorded music has been made in order to collect results, which may be interpreted as a closer representation of real listening conditions.

Various points of criticism regarding these issues may be raised. The first is that the use of music signals may provide results that are too specific for the style of music or, more specifically, the sample chosen. In some of the tests, this factor is actually investigated and the results show no significant effect of varying the music styles. This does not mean, however, that all tests are independent of the effects of the specific sample used and this is a fact that is taken into account when interpreting the results.

As far as headphone reproduction is concerned, it is understandable that the listening experience may be somewhat different to that gained in a real room, especially at low frequencies, where body vibration may be a significant perceptual factor. Furthermore, a mismatch necessarily occurs between the visual clues that inform the listener of the space s/he is in and the auditory spatial information provided during experimental audition. These are unavoidable factors that distinguish the test set-up from a real audio room environment and appear as limitations in its precise 'simulation'.

Despite these criticisms, the advantages outlined earlier are considered to supersede the possible negative effects that such assumptions may lead to. All the results should however be interpreted in the context of the experimental procedures.

1.6 Contributions and main findings

The work presented is novel in the fact that it studies the effects of room modes as perceived in the relevant acoustic sound fields rather than distanced from it in the form of isolated resonances. This is a topic that has been widely discussed but hitherto not largely addressed by research. The definition of the relative importance of factors such as modal distribution, frequency response or decay as experienced by listeners in rooms directly addresses the update of recommendations for critical listening conditions. Furthermore, the results found may be

used in guiding future techniques of modal control into those sound field parameters that are worthwhile addressing and in the definition of control targets that are associated with perceptual improvements.

In particular, the work presented demonstrates that subjective perception of room modes is strongly affected by temporal issues, and consequently the detection of the effects of resonances on the reproduced sound is very much dependent on the temporal distortions² introduced. It is also established that techniques based solely on frequency parameters are unreliable in describing the amelioration of low frequency conditions.

Furthermore, it is shown that reducing the Q-factor (quality factor) of resonances, therefore reducing their decay rates, has a significant effect in decreasing the detection of resonant effects. This indicates that a reduction of Q-factor is a subjectively powerful technique to ameliorate the problems of room modes. This result may appear self-evident, but the reader should beware the conflation of anecdotally accepted knowledge with the test evidence presented here.

Following this, the derivation of a *one sided*³ difference limen for reductions in Q-factor of resonances indicates the changes necessary to achieve perceptible differences in the room environment. The results presented show that the difference limen increases as the absolute value of Q-factor decreases, which means that perceptual changes in the modal sound field are increasingly more difficult to achieve as the low frequency decays in the room tend towards a lower value.

1.7 Thesis structure

The thesis has been structured so as to separate the research context from the author's contribution. Review work is presented in the earlier Chapters 2 and 3 and main contributions may be found in the later Chapters 6, 7 and 8, where the experimental procedures, results and discussions are detailed. Chapters 4 and 5 are presented as rationales for the investigation. Although with smaller impact, the results from these two chapters also contribute to further knowledge in the field under study and form an important link between the review and the main contribution material.

References to equations and figures include chapter number followed by the equation or figure number.

A brief description of the contents in each chapter is provided below.

²Throughout this thesis, 'distortion' is used to describe a change in the shape, appearance or sound of something. It should not be interpreted as an introduction of extra frequency components as is the case in non-linear systems.

³ Difference limen identified as the detection of a change in one direction only.

Relevant literature for the field under study is reviewed in Chapter 2. The literature reviewed enables the understanding of existing knowledge on the research issue and the identification of research gaps.

The underlying theory necessary to understand the problems of resonances in enclosed spaces is briefly reviewed and provides a basis for the theory review presented in Chapter 3.

Common methods for the control of room modes are reviewed. This provides an indication of the different control techniques available, the objective factors that each method addresses and the control changes imparted to these factors.

A review of the current research into the topic of perception of resonances is presented. This forms the most important part of the literature review, as it not only indicates gaps in the current knowledge for the specific issue addressed in the thesis but also guides in the basic understanding of the auditory perception of resonances.

Chapter 3 presents a review of the theory necessary for the understanding of the mechanisms underlying resonances in enclosed spaces. More specifically, the analytical expressions describing the sound field behaviour are revisited. A low frequency analytical model is used to study the objective effects of resonances in rooms. An understanding of this model is fundamental, as it will be used to generate room modal conditions in subsequent chapters. The derivation of a rectangular piston as a source, used in an investigation of the sound field generated by complex sources, is also demonstrated.

In Chapter 4, a qualitative study carried out on the preferences and views of control room users is presented. This demonstrates empirical evidence of the frequent occurrence of low frequency problems in current state-of-the-art control rooms and how this subject is still one of the main sources of concern in critical monitoring environments.

A practical study into the control of room modes is presented in Chapter 5. This was carried out in order to gain a deeper knowledge into the implications of modal control methods. Two types of control approach are presented. In the first part, the control of two critical listening spaces is implemented using resonant membrane absorbers. This practical application permits a study based on empirical evidence into the objective factors altered in the room, such as frequency response alterations and decay times. The practical results are evaluated in the light of the findings from the subjective investigations presented in later chapters.

The second part of Chapter 5 investigates the use of distributed mode loudspeakers as a means to obtain an improved modal excitation. This investigation is carried out using prediction models which are based on the theoretical model described in Chapter 3, but use more complex sources to generate the low frequencies. Analytical expressions that allow the evaluation of

distributed sources in rooms are derived and presented. This enables the prediction of sound fields generated by the interaction of distributed sources and the room. Their adequacy as a means to generate low frequencies in rooms is investigated. Objective issues, such as modal density and modal decay are studied.

Chapters 6, 7 and 8 concentrate on the subjective perception of resonances in rooms and form the main contribution from this investigation.

Chapter 6 presents a study into the perception of changes in modal distribution and its dependence on room aspect ratios. This study originates in the need to evaluate the usefulness of a difference limen based on metrics currently used to rank the subjective quality of rooms according to their aspect ratios. It is shown that, although changes in modal distribution are highly detectable, the use of room ratios as a means of modal control is insufficient, given that any modal distribution leads to high detection of resonance effects. The high detection identified even for cases with adjacent scores on the metrics studied suggests that the derivation of difference limen for modal distribution is perhaps meaningless.

During this investigation it is identified that the detection of resonances using music signals is strongly dependent on the relationship between the content of the signals both in time and frequency, and how single notes match specific frequencies in the room response.

This result was further investigated in Chapter 7 where a dedicated study of objective effects of room resonances on single tones is presented. The subjective detection of these is then investigated using two types of input signal (a transient signal and a long tone burst) and three common resonance situations found in rooms (i.e. resonance, anti-resonance and off-resonance). It is shown that if amplitude differences are removed, the detection of the effects of resonances is only possible with transient stimuli. Furthermore, it is shown that differences between resonances and anti-resonances are detected in the presence of transient input stimuli. A further test shows that when the Q-factor of the resonances is reduced, the detection ability is drastically compromised, even in the presence of transient stimuli.

With perceptible changes in Q-factor justified, in Chapter 8 a procedure to extract the difference limen for the Q-factor of room modes in the presence of music signals is presented. This study also investigates the effects of mid-frequency reverberation time on the ability to detect changes in the Q-factor of room modes. It is shown that the difference limen increases monotonically at higher mid-frequency reverberation time values. Furthermore, results indicate that subjective detection of differences in Q-factor diminishes as the target Q value becomes smaller. Guidance for practical use of the derived difference limen is suggested.

Finally, Chapter 9 presents the conclusions of the investigation and discusses the implications in both academic and industrial fields. Suggested investigations for further work are described.

2 Literature Review

2.1 Introduction

Chapter 1 set out the research problem and its rationale. Chapter 2 concentrates on presenting a review of the relevant literature on the research areas being investigated. Given the diverse range of fields covered in this thesis, the literature review is divided into sections that cover the relevant work in those areas that contributed to and determined the course of investigation.

Section 2.2 concentrates on the background theory necessary to understand the mechanisms underpinning the behaviour of room modes and the definition of analytical models that enable its study. These models not only provide an understanding of the problem from a physical perspective but also enable the simulation of modal sound-fields, which are used for subjective tests on the perception of modal factors. Although there are examples of other textbooks and journal publications covering these areas, there is no intention to present a full review of the literature in this field.

Section 2.3 reviews some of the most common methods developed to control room modes. This section presents a collection of the relevant work done in this field. The objective is to place in context the various control methods and identify the modal parameters modified by them. The review covers general areas such as the pre-definition of room aspect ratios, passive absorption, pre-and post- equalisation of source-room interaction and more sophisticated techniques based on active control. These areas are reviewed in the context of modifications imparted to objective parameters such as modal density, time and frequency responses and Q-factor of room modes. This review directs a focused and informed study of the effects of these parameters on Human perception, which is addressed in the latter chapters.

Finally, in section 2.5, a comprehensive review of previous research carried out on the subjective perception of resonances at low frequencies is presented. Knowledge on the subjective perception of parameters in room modes is of significant value and importance as it provides guidance and target levels for existing and novel control techniques. This is one of the most important fields reviewed, as it covers the area where most of the novelty in this thesis emerges. The review of previous work leads to an understanding of the perception of objective parameters associated with room modes and it also identifies the areas where further knowledge is required. Early research is reviewed in the areas of loudspeaker quality, perception of low frequency resonances and more focused experiments on the perception of room modes. This review provides an indication of the most important studies in the area hitherto and their relevance to the research problem being investigated.

2.2 Modal theory

Modal theory in this case is concerned with the study of enclosed sound fields. The study of rooms has commonly been divided into two frequency regions – high and low frequencies (Morse 1948). This division has emerged from the fact that the convenient statistical analysis commonly employed to study sound fields is only possible when the modal density in the room is high enough and the acoustical sound field may be assumed diffuse. Indeed, this division of frequency regions has a basis on subjective perception given that the criterion most commonly used to define the change over frequency, the *Schroeder frequency*, is based on the existence of at least three modes within one critical frequency bandwidth.

At low frequencies, the sound field in rooms is typically composed of specific modes, which are well separated in frequency. Its behaviour is best described by the use of wave theory. The wave solution, borrowing ideas from the Fourier analysis, presents the decomposition of pressure into an infinite summation of orthogonal components with specified spatial and frequency domain behaviour. Following some assumptions, which will be described later, this method allows a sufficiently accurate description of the general characteristics of modal sound fields such as modal density and time responses which are observable in most rooms.

The study of the sound field in an enclosed space is much simplified if the room is assumed to be rectangular and lightly damped. Although this describes an ideal situation, the results obtained for rectangular rooms may be extrapolated, at least qualitatively, to other more complex shapes (Kuttruff 2000). Furthermore, in many real applications for critical listening spaces, the assumption of a lightly damped cuboid may be considered as a truthful representation for the study of enclosed sound fields as most practical rooms are rectangular in shape and have reduced low frequency absorption.

The wave theory in rectangular rooms is presented in Kuttruff's *Room Acoustics* (Kuttruff 2000) in a clear and modern manner. The solution to the wave equation is derived for rectangular rooms with low damping. The *modal decomposition model* described in Chapter 3 is based on this work and is considered sufficient for modelling the sound field in most rooms at low frequencies.

These models have been used in studies on potential remedial techniques for the problem of room modes (Walker 1992 a and b). The predictions have been successfully validated by measurements in real rooms, providing further evidence that the model is a sufficient description of the sound field.

Other approaches have been used to model the sound field of rooms at low frequencies. Morjopoulos et al. (1991) presented an investigation into the use of all-pole and all-zero filters

for modelling room responses. The aim of this investigation was to implement a system to invert room transfer functions in order to solve the problem of room modes. The investigation shows that by reducing the order of digital filters to model the room, its response may be inverted more efficiently than using models based on filters with a much higher order, such as the ones obtained from direct inversion of transfer functions. It is shown that room approximations with all-pole models, which describe room transfer function resonances, are advantageous over all-zero models, representing transfer function notches. Similar models are used in Chapters 7 and 8, where room resonances are modelled using a cascade of bi-quad IIR filters.

The source-room interaction is successfully covered by the models referred earlier (e.g. Kuttruff 2000). Further studies into the effects of loudspeaker-room interface are demonstrated in the work by Ferekidis et al. (1996). In particular, this investigation determines that the modal response in the room is not only dependent on the source position but also on its polar radiation pattern. The effects of low frequency room excitation using monopole and dipole sources are demonstrated, and it is shown that, due to their different radiating behaviour, dipole sources may be orientated with regards to their directivity angle in order to achieve the desired coupling with the mode-shapes. The study suggests that the use of sources with different radiation patterns may provide a higher degree of control that could not possibly be matched by the use of a single monopole source.

2.3 Modal control

This section provides a review of the developments made in the field of modal control. The term *modal control* used in this review entails all possible treatment methods that attempt to ameliorate the effects of room resonances. This includes both passive types of treatment such as resonant and bulk absorption as well as active control techniques, which imply a de-convolution of the source-room transfer function either before it is generated in the room or by interaction with additional electroacoustic sources. Whilst an effort has been made to cover all fields of control and main developments in the area, the main purpose of this section is to provide the reader with a background of the various techniques available and to compare these in the context of the objective factors that are modified in the sound field.

The first method reviewed here is different in principle from all others, given that it is based on a preventive measure that establishes room aspect ratios to avoid modal degeneracy and achieve 'optimal' modal distribution.

The control of the modal sound field in rooms is a well known problem and indeed this matter has been the focus of much research for a number of decades (e.g. Bolt 1939 a,c; Louden 1971; Farnsworth et al. 1985; Antsalo et al. 2003).

Preventive methods have been employed to avoid the problem of degenerate modes. The methods are considered preventive rather than a means of control as they are based on the determination of the room aspect ratios prior to the construction of the room.

Changing the aspect ratio of a room alters the centre frequencies of its natural resonances, with larger consequences at the lower frequencies where the concentration of modes is sparse. The main objective of choosing appropriate aspect ratios concentrates on avoiding *degenerate modes*⁴ and large frequency regions without any modal support. This directly affects the modal distribution of a room.

Authors have suggested the ranking of room aspect ratios according to their subjective ‘quality’ based on measures of modal distribution (Bolt 1939; Louden 1971; Bonello 1985; Cox et al. 1997). Designers could then select from a list of available ratios in order to achieve a ‘good’ modal distribution and avoid problems of degeneracy.

Underpinning the work on aspect ratios is the frequency distribution of room resonances. Bolt concentrated on the distribution of resonances in rooms as early as 1939 (Bolt 1939 a). The theory previously published by Morse (1936) is revisited and expressions are derived for the average number of modes expected below a designated frequency. Maa (1939), also during this period, arrives to a new set of equations that describe the same quantity.

On a second visit to the issue of frequency spacing for room modes, Bolt (1947) presents the derivation of an index that describes the average frequency spacing for modes, independently of room volume. This enables a study of room proportions unbiased from the influence of room volume.

The issue of room aspect ratios is studied further by Louden (1971), which makes use of the equations for modal density previously used by Morse, Bolt and others. Louden ranks the acoustical quality of room aspect ratios according to their score on a metric based on the standard deviation of frequency spacing between modes, and publishes a list of suggested aspect ratios with corresponding metric scores from best to worse.

In 1981, Bonello devised a new criterion to qualify room aspect ratios. This criterion is based on the assumption that modes within one critical bandwidth will be perceived as a total sound energy rather than discriminated as individual resonances. This assumption is derived from

⁴ Two or more resonances with the same centre frequency.

previous research on the auditory response to musical intervals (Moore 2003). In Bonello's criterion, an analysis is made of the number of modes within a predetermined relative bandwidth, up to a cut off frequency. The criterion prescribes that the number of modes in subsequent bandwidths should be equal or larger than the ones in the preceding bandwidth, to ensure a 'good' modal response. Degeneracy is not allowed unless the band in question has three or more non-degenerate modes to counteract the large amplitude caused by the two coincident ones. The general psychoacoustic assumptions underlying this method make it a powerful method to decide on suitable aspect ratios. However, using this technique, to determine if a certain aspect ratio qualifies as a 'good' room, one has to calculate the centre frequencies of all the possible modes and apply the criteria. This fact makes the decision of an optimum aspect ratio rather protracted, as the criteria only validates rather than determine good aspect ratios.

A comparison is made with other criteria for room ratios, including the famous Bolt chart for optimum aspect ratios (Listed in Irvine et al. 1997). Bonello's criterion validates some of the rooms considered optimum in Bolt's chart. However, it also validates rooms outside the optimum area and excludes others well inside. This discrepancy is attributed to the dependence on room volume in Bolt's work.

The work reviewed on room aspect ratios has hitherto been based on the determination of all supported modes in the room without knowledge of damping characteristics and source-receiver position in the room. Notwithstanding, in Bonello's criterion (Bonello 1981), the possibility of some control on the bandwidth within which one should take modes into account may enable the factor of damping to be introduced. Notwithstanding, all methods discussed up to this point assume that all resonances will equally contribute to the low frequency response in the room, and that only the 'correct' distribution of all modes will lead to an overall improvement of perception in the whole space.

Other authors have departed from this concept and their methods take into account the magnitude frequency response variation determined for a single source-receiver transfer function (Cox and D'Antonio 1997). This technique addresses the problem of frequency response irregularities in rooms by predicting the impulse response at the listener position according to a specific source location in the room. Its potential is that the results are also dependent on source-receiver positions and the damping characteristics in the room, although the validity of the latter is dependent on the models of prediction used. An optimisation procedure is suggested, that elects room ratios and optimal source and receiver locations based on a figure of merit that is determined from the magnitude frequency response. The optimisation process looks for the combination of factors that result in the flattest frequency response at the listener position. In this case, the process converges to a minimum in an optimisation 'error'

parameter. Hitherto, this minimum has been decided somewhat arbitrarily, but could be guided by a difference limen for changes in modal distribution. This topic will be further addressed in Chapter 6.

The investigations on modal control presented hitherto have concentrated on preventive means of avoiding the problem of strong modal degeneracy and its associated pressure fluctuation by altering the room dimensions. Although an efficient method to avoid extreme modal problems, this technique is only capable of changing the centre frequencies of the resonances, without any effect on their individual magnitude or decay responses. Furthermore, the technique may only be used prior to the construction of the rooms making it unsuitable as a means of ‘treatment’ as is usually necessary. The next section presents examples of modal control techniques that may be applied to ‘correct’ the response of existing rooms.

The most common method for acoustic control is that of absorption. Passive means of absorption are well understood and have been employed with success in the control of reverberation times or early reflections in rooms at mid- to high frequencies (e.g. Newell 1995; Kuttruff 2000). However, their efficiency in the control of low frequencies is undermined by the large wavelengths involved. The need for more efficient and less space consumptive absorption methods has led to the development of resonators as absorbers.

The design of one common type of resonant absorber has been originally credited to Helmholtz. However, examples of this type of technique are found as far back as the Greek and Roman eras (Quoted in Everest 1994). The performance of a *helmholtz resonator* relies on a ‘mass’ of air forced to travel up and down a tube, which is terminated by an air cavity (Cox et al 2004). The system has a resonant frequency determined by the physical characteristics of its components. More modern applications of this technique are common in construction, e.g. by the use of gaps between bricks with an air cavity behind, and in acoustic control applications, e.g. perforated board.

Because it relies on the movement of air in and out of the cavity-tube system, helmholtz absorbers are more efficient when placed in zones with high particle velocity. Unfortunately, this means they should be placed away from the boundaries of the space and not on the walls where they are commonly installed.

Another type of resonator, by principle, works best when placed at high pressure zones, and is commonly referred to as a resonant membrane absorber. This type of absorber is comprised of a thin membrane, which forms the face of an enclosed volume of air (e.g. Fuchs et al. 2000; Kuttruff 2000; Cox and D’Antonio 2004). Its behaviour is typical of a mass on a spring system, and as such, has a ‘tuneable’ resonant frequency. The acoustic energy is transformed into heat by vibrational losses in the membrane and in the viscous material placed inside the cavity.

Absorbers of this type are commonly found in applications to control the effects of room modes (e.g. Fuchs et al. 2000).

Due to their resonant behaviour, resonant absorbers achieve high performance from a relatively shallow device, therefore making them more attractive for the control of low frequencies. The absorption performance is limited to a bandwidth around the resonant frequency, where maximum absorption is achieved (Everest 1994; Cox and D'Antonio 2004).

It is known that absorption reduces the reverberation time of rooms by removing energy from each reflection at the boundaries of the space. In the case of room resonances, efficient absorption is translated into a reduction of their decay rates and a consequential reduction of their Q-factor.

Absorption has also been found originating in the construction materials that form the boundaries of the room (Bradley 1997; Maluski and Gibbs 2004). This has been attributed to wall vibration, which imparts some damping to the room modes. Indeed, the issue of sound absorption is closely related to the sound isolation properties of the rooms. If the walls vibrate, sound energy is transmitted to the outside. Conservation of energy laws dictate that this energy is therefore removed from inside the room. If a rigid outer shell exists, then an enclosed volume of air, which is usually filled with viscous material, effectively backs the inner lighter walls. The whole system may be considered a full-scale resonant membrane absorber. This type of wall construction has been demonstrated to lower the Q-factor of resonances (Maluski and Gibbs 2004).

A complex wideband absorption system resulted from years of practical application and research in control room design (Newell and Holland 2003). The design approach has been rather pragmatic and based on experimental results. Studies on the behaviour of the whole system have recognised its performance from effects of membrane-wall absorption, 'seat-dip' attenuation and wave-guides. The technique uses a system of hanging panels covered with thin porous material and placed in arrays at specific angles in front of light partition inner walls. Its performance has been demonstrated to achieve decays as low as 200 milliseconds down to frequencies below 100 Hz (Newell and Holland 2003), albeit using deeper absorption areas than other conventional techniques.

In some applications, the installation of absorption material may be undesirable due to aesthetics or prohibitive use of space. In such cases, low frequency control is still possible but has to be addressed at the source of sound or through single or multiple source interaction with the modal sound field.

One technique that has claimed some control in the low frequency reproduction is that of magnitude equalisation. This technique, presupposes that the level of excitation of a certain

mode may be controlled either by the position of the source relative to the mode-shapes or by adjusting the gain of the source at that specific frequency (Groh 1971). Groh investigates a method where equalisation is achieved by placement of the source, and foresees the application of this using computer optimisation. A similar approach is later put into practice by Cox et al (1997).

Optimising the position of one or various sources has indeed found commercial applications especially in the 'home-cinema' type of systems. The use of a dedicated low frequency source allows for sound reproduction to be optimised by careful positioning of the source with regards to the mode-shapes. Loudspeaker manufacturers are now taking this approach further by applying this technique allied to the interaction effects between multiple coherent sources (e.g. Welti et al. 2003). Welti et al. (2003) explored a practical application in optimising low frequency reproduction in listening rooms. The method employs a number of low frequency sources (4 to 8) and optimisation parameters such as position, gain and filter settings to achieve the best possible response in an extended listening area. This optimisation is based on reducing the mean spatial variance, at various positions in a listening area, and the mean frequency variance, determined up to 80 Hz. It is shown that the method successfully improves listening conditions, but the coarse optional settings used for the control parameters (for example only three gain stages or three Q factor settings) hinder a better performance and optimum settings from being implemented.

As mentioned previously, magnitude equalisation may also be achieved by controlling the source gain at specific frequencies where problems are evident. Indeed, more attractive methods that don't require careful positioning of the source and rely on magnitude control over the source frequency response have been suggested for modal control applications (e.g. Boner 1965). Nowadays, dedicated systems are found in the market which specifically address the equalisation of room modes by offering control over gain, centre frequency and Q-factor (rivesaudio 2003). The reproduction system is installed in the room, sometimes without any regard to the actual coupling between source and mode-shape, and a conventional equaliser that 'corrects' the steady state response at a position in the room is then used. This method has been limited in the past by the fact that some of the room irregularities could exceed the range available in electronic equalisers as well as the power handling capabilities of loudspeakers (Groh 1971). The progress of digital devices has enabled this type of control to achieve a better performance in the proposed task (Pedersen 2003).

Despite their popularity, simple magnitude equalisation only addresses the forced response of the room, therefore allowing the effects of resonances to appear as the long decays of the modes dominate the natural response of the room (Darlington et al. 1996). Consequently, the benefits

introduced by this technique will be severely threatened in conditions where strong low frequency transient signals are present.

Much of the more recent work on the control of room modes finds its base on the advent of active control. This is an idea that was first patented in 1933 by a German physicist, Paul Lueg, who apparently did not receive the credit for its invention until many years after (Guicking, 1990). Active control presupposes the use of secondary radiators, which create selective perturbations in the sound field to achieve a complete de-convolution of the transmission path between source and receiver. These methods have allowed more powerful control over the modes that was not possible with conventional absorption, especially in the case of very high Q resonances (Bullmore et al. 1987; Herzog et al. 1995; Darlington et al. 1996).

More recent research has concentrated on solving the problem of room modes by attempting to deconvolve the room transfer function at some listening location (Neely 1979; Farnsworth 1985; Morjopoulos 1985). The control target, determined for a receiver position, is set as a delta function representing an unaltered impulse response from source to receiver. In general this practice is successful if the transfer function is minimum phase (Neely 1979). These are of particular importance due to the fact that their inverses are also minimum phase functions and lead to causal types of filter designs. If the impulse response to be inverted is not minimum phase, its inverse will be unstable and acausal, and a full deconvolution is not possible.

Other investigations on the benefits and design of active control have been pursued, where the aim has been to minimize pressure fluctuations over a relatively large listening area. The approach on this subject by Bullmore et al. (1987) uses rectangular pistons to model the control sources. The control target is defined as a minimisation of the sum of squared pressures at a number of discrete sensor locations. This concept has also been used by other authors (Asano et al. 1995). The success of the technique is dependent on the importance of sensor and control source location relative to the mode-shapes.

The inversion of transfer functions is promising in theory, as it completely removes the effects of source-room transmission path addressing both magnitude frequency as well as temporal problems. However, this de-reverberation process is reported by Fielder (2003) to suffer from errors that may introduce audible effects, again dependent on the phase conditions of the transfer function. Extreme sensitivity to the target location is also reported, making the method very critical for a single position in the room. It is shown that this technique is successful for a specific source-receiver pair but actually deteriorates the response at other receiver positions (Neely 1979; Farnsworth 1985).

Other authors have concentrated on the optimisation of the response at a specific point in a one dimensional sound field using digital signal processing techniques (Darlington et al. 1996; Avis

2002). It is shown that the implementation of a secondary source to act as a characteristic termination at the opposite end of the duct minimises the response by reducing the quality factor of resonances. This technique of controlling the Q-factor of offending resonances will later be put into practice in three-dimensional control systems (Makivirta et al. 2003). An interesting contrast is presented between normal magnitude equalisation and active absorption. It is shown that full control of the steady state and free response of the room is only possible using the latter method.

A similar approach relying on interaction between sources in the sound field has been proposed by Santillan (2001). This approach to sound field equalisation employs a considerable number of sources to generate a plane wave in one of the room's axis. The sources are placed in such positions to avoid excitation of modes in the other two coordinates. The sources at the end wall are then controlled to radiate in anti-phase with the impinging wave. The method is based on the minimisation of an error function at discrete sensor positions. However, parameters selected to model the damping, associated with a decay time of 0.2 seconds at 180 Hz, appear excessive for such low frequencies in lightly damped rooms and raise the question if any control would be subjectively required if such conditions are found *a priori*. It is shown that the method is effective in achieving a homogeneous sound field in a large portion of the enclosed volume, as it is desirable, although the use of a large number of sources may render this solution rather costly.

More recently, the growing interest in loudspeaker-room interaction, especially at low frequencies, has led many loudspeaker manufacturers to turn their attention not only to the 'measurable' quality of their loudspeaker in controlled conditions (anechoic rooms), but also to the subjective perception and interaction with the rooms where they will be used (Welti et al. 2003; Makivirta et al. 2003).

The current approaches by Makivirta et al. appear most promising as they address both the magnitude and temporal responses in the room (Makivirta et al. 2003; Antsallo 2003). Although using common dereverberation techniques, these authors depart from the objective of full deconvolution of the sound field at some target. The concentration on the low frequencies, where the wavelength is large compared to the size of the source imparts a higher degree of certainty in the control system. Furthermore, the control target in this case is to reduce low frequency decay rates in order to achieve internationally accepted recommendations for reverberation time in critical listening spaces (IEC 268-13 1985; ITU-R BS 1116-1 1994; BS 6840: Part 13 1987), rather than to attempt a complete deconvolution. This follows from previous findings by Darlington et al. (1996) who concentrated on the design of pole-zero filters to reduce the quality factor of resonances, therefore decreasing their decay rate. Also for Makivirta et al., the use of pole-zero filters is central to the control models.

A contrast between conventional magnitude equalisation and the above mentioned active control methods has been presented (Antsalò et al. 2003). An interesting subjective study queries the efficacy of the system given that the obtained results do not offer statistical support for the benefits of the more sophisticated active control methods. Further subjective studies are therefore solicited.

2.4 Subjective perception of resonances

An investigation into the subjective perception of the many factors associated with room resonances provides means of measuring the efficacy of the treatment methods, and guides future efforts into those factors that afford greater benefits to the control task.

A thorough investigation on the perception of resonances has to start on the first studies that concentrate on frequency selectivity and temporal auditory perception. These have been investigated and explained in reasonable depth by Moore (2003).

Concepts such as the *auditory critical bandwidth* and the *equivalent rectangular bandwidth* are the basis for many of the assumptions in the study of room modes, and indeed have been found in concepts such as the Schroeder frequency that defines the cross-over frequency between modal and statistical regions of enclosed sound fields. This measure is based on the existence of a minimum overlap between adjacent resonances that will be perceived by the auditory system as a single energy event (Howard et al. 1998).

The masking effects of low frequencies are also an important concept that reinforces the importance of solving the problems of room modes not only to support a correct reproduction of the low frequencies but also to allow it at the higher frequency range. Furthermore, amplitude modulation and more specifically the audibility of first order beats are also connected to the perception of resonances as will be further demonstrated in Chapter 7.

The dedicated study of the effects of resonances goes as far back as 1962. One of the first investigations that concentrated on the audibility of resonances is that of Bucklein, originally carried out in 1962 and published in 1981 (Bucklein 1981). Bucklein identifies that resonances are more audible than their equivalent anti-resonances. Standing out in Bucklein's research is the fact that the introduction of a time gap between the audition of the test samples increases the uncertainty of detection, especially when the difference between the distorted signal (with added resonance) and the reference signal is small (+5dB). This 'acoustic memory' effect seems to play an important role in the detection of differences. Bucklein also found that when the stimulus is composed of sound from musical instruments, detection is only possible when the played tones fall in the region of the resonance. Although emerging from different testing methods, this finding is further confirmed by the results in Chapter 6.

The work of Bucklein was followed by Fryer in 1975, who shows that the effects of resonances are more noticeable in the presence of pure tones as opposed to music signals. This is an important concept as it suggests that the more complex nature of musical signals may affect the detection of effects caused by resonances, therefore supporting investigations which replicate conditions as found in critical listening spaces.

Toole and Olive (1988) further investigated the existence of a room environment or reverberation during the detection tasks. Although the range of this study covers higher frequencies, the results extracted for the low frequencies ($f=200\text{Hz}$) show that in anechoic conditions, medium ($Q=10$) and low ($Q=1$) Q resonances appear to be more easily detected in the presence of broadband signals, whereas in typical listening conditions, the temporal nature of the signals does not appear to affect detection regardless of Q. Other results indicate that the detection of resonances in broadband signals is not affected by listening conditions. Conversely, it is shown that when a transient signal is used (10ms pulses at 10 Hz rate), lower and medium Q resonances are more easily detected in a typical listening room environment. This reveals that added reverberation increases the detection of low Q resonances, but does not alter the perception of high Q resonances. The explanation given for this is that low frequency, high Q resonances when repeated at this rate, do actually form a more continuous signal since the 'ringing' tails join each pulse to the adjacent one. This is an important factor, due to increasingly longer resonant decays as frequency decreases. This may explain why at the full experimental frequency range (200 Hz – 10 KHz) in Toole and Olive's research, lower Q resonances are more audible than higher Q ones, given that at this range the decays of resonances are shorter and therefore the changes in the frequency response become more noticeable than their associated decays.

It is interesting to note that most of the above mentioned studies have led to similar conclusions. For example, it is shown that resonances are more audible than their equivalent anti-resonances, especially using steady state signals such as white or pink noise. Results also show that lower Q-factors are usually associated with a higher level of detection. However, this may be an issue for discussion, given that while Bucklein has tested a range of Q from 1.8 to 5, which may be considered quite low, later investigation tested for Q-factors ranging from 1 to above 30. Another interesting common result is that resonances appear to be more easily detected in the presence of broadband steady state signals. Most of this investigation reveals that the detection thresholds are increased when music or speech signals are used (Bucklein 1981; Toole and Olive 1988), indicating that the effects of resonances are most difficult to detect in the presence of real signals.

In general the above work has concentrated on the 150 Hz to 10 KHz frequency range. In 1997, Olive et al. investigated the low frequency region in more detail. Specific attention has been

devoted to the low frequency range 63Hz to 500 Hz. Indeed, the research by Olive et al. confirms previous findings (Bucklein 1981) that in the presence of pink noise the detection rates decrease with increasing Q factor. It is also shown that, for broadband steady state signals, detection worsens as frequency decreases with exception of lower Q resonance detection, which appears to be independent of frequency. However, an interesting result shows that temporal aspects of the signal are important in the detection of resonances, and that when transient signals (pulses) are used, the detection thresholds actually decrease considerably at higher Q values ($Q=30$). Additionally, and under such conditions (transient signal, high Q), anti-resonances are as detectable as their equivalent resonances. These results suggest that, in the presence of music signals, which are in nature comprised of many transients, room resonances may impart a much different perception when compared to broadband steady state signals. Moore (2003), albeit indirectly, also makes reference to this issue, stating that the detection of gaps is dramatically different at very low frequencies (below 200 Hz) from that measured at the rest of the auditory range. This is shown to be associated with a 'ringing' property of the auditory filter which is experimentally determined around 18 ms. Although this is much shorter than any of the effects detected in room situations, it shows that the behaviour of the auditory system at low frequencies becomes considerably different to that across the rest of the auditory range, and that inferences made for a higher frequency range may not be applicable at low frequencies.

On a general review concerned with subjective perception of resonances, Toole presents interesting remarks regarding the existence of irregularities in loudspeaker performance (1986). Toole assumes the viewpoint that even though intuitively one would expect high Q, longer resonant modes to be more perceptible, in reality those of wider bandwidth are more detectable. One hypothesis suggested is that from a statistical point of view, a broader resonance is more often excited by musical sounds than a narrower resonance, due to its 'spread' in frequency. Furthermore, the sounds that are likely to 'drive' these resonances will be of a transient nature, therefore exciting full amplitude low Q resonances more often and more quickly than those of high Q, which have an inherently long temporal behaviour. Moreover, due to their frequency bandwidth, higher Q resonances are more likely to resonate at the same frequency of the exciting sound, whereas lower Q resonances will shift in frequency as the excitation sound is removed and impart a monotonical sound to a larger range of exciting frequencies, hence making this type of resonance more likely to be detected. Although speculative and lacking in empirical evidence from subjective listening experiments, these are interesting remarks. The findings in Chapters 7 and 8 actually contradict some of these remarks offering an explanation to the effects observed.

The issue of perception of reverberation in critical listening rooms is addressed by Newell et al. (1994) and Newell and Holland (1997). It is argued that reverberation interferes with the clear

perception of the sound being monitored. Uniformity of listening conditions is suggested by removing this ‘variable’ from the monitoring environment. The exposition of this idea goes further pointing out that the large qualitative differences perceived between monitoring rooms used for critical listening are particularly associated with the effects of room resonances and the alterations these induce on the perception of sound. This is not surprising given that the modal range is the most difficult to control. This fact is further reinforced by the results of the qualitative study carried out in Chapter 4. Furthermore, these remarks reinforce the importance of controlling the long decays originated in room resonances in order to achieve uniformity in low frequency reproduction in critical listening spaces.

The specific perception of room modes is studied by Salava (1991) in the performance of listening rooms at low frequencies. The use of specifically tuned tone burst signals (short windowed sine waves) is employed to excite the room responses, and this is a technique that is revisited in Chapter 7. An informal subjective appraisal of the differences between a signal and its simulated response to a resonance is carried out. Unfortunately the author provides little information about the experimental method and no critical discussion of the implications of results is given.

Loudspeaker positioning in rooms and its effect on listener preference is a subject that has been studied specifically (Olive et al. 1994; Bech 1994). Bech demonstrated that this issue is directly related to the spatial distribution of modes. The results presented by Olive et al. (1994) and Bech (1994) clearly demonstrate that the preference of listeners is more strongly influenced by the position of the source or the size of the room than by the different loudspeakers used. Bech also states that moving the loudspeaker by a radius of about 0.5 metres does not introduce significant changes. This clearly suggests that most of these preferences and effects are in fact associated with the coupling between the source and mode-shapes given the large wavelength involved and the small effect of short source displacements.

In general, tests on the subjective perception of resonances were carried out using common test signals such as noise or pulses (Fryer 1975; Bucklein 1981; Toole and Olive 1988; Olive et al. 1997). Although utilising signals with well known characteristics and therefore easier to analyse, these tests have been somewhat distanced from real applications since most of the audio industry is concerned with the recording-reproduction of musical and speech signals. Despite this, results from these experiments have provided a basis on which to model possible control methods and further subjective investigation. Indeed, many of the experiments reported do actually develop onto a second stage, where more ‘real’ music and speech signals are used (Fryer 1975; Bucklein 1981). This encourages the methods utilised in this thesis where most experiments are carried out with ‘real’ music samples.

It has been referred throughout this review that the effects of control methods impart a change to the decay times of resonances. Although concentrating on the mid-frequency range, Niaounakis and Davies (2002) discuss the determination of a difference limen for changes in reverberation time in small rooms. These results may be used as a departing point to assess the suitability of certain methods in achieving a subjectively perceptible change in room decays. The study reveals a detection of reverberation changes as small as 0.042 seconds, when in the presence of music stimuli. Unfortunately, the authors do not reveal the frequency range of their results, which renders these results indicative rather than a definite reference when comparing to values presented in this thesis.

Finally, a recent study on the subjective perception of temporal decay of modes is presented by Karjalainen et al. (2004). Just noticeable differences are presented for a single resonance with variable centre frequency in the presence of other room resonances in the range 50 Hz to 800 Hz. The results show that an increase of 25 % on a reverberation time of 0.3 seconds down to 100 Hz is just noticeable, whilst below this frequency, changes to the reverberation time in excess of 2 seconds are not noticeable. These results are larger than the difference limen (DL) defined in Chapter 8 of this thesis, but the different methods used in extracting them may account for these differences. Notwithstanding, the findings by Karjalainen et al. contradict to some extent those by Niaounakis et al. that suggest a DL of merely 0.042 seconds at mid frequencies contrasted to the values of 0.26 and 0.28 seconds found by Karjalainen for the frequencies 400 Hz and 800 Hz.

2.5 Summary

This chapter presented a review of the most relevant literature on topics directly related to the work presented in this thesis.

A brief review of theoretical models used for describing the sound fields in enclosed spaces has been given along with corroboration of their suitability in describing the cases under study.

The review on modal control has covered the available methods to control the undesired effects of room modes. It has been shown that these methods attempt to control measurable factors of the modal response such as magnitude and temporal decays. It has been further shown that methods that do not address the temporal response of the resonances are somewhat ineffective in achieving full objective control.

The evaluation of the efficacy of any control method should be based on its subjective perception. It has been shown that successful design of control techniques should make use of knowledge on the subjective perception of the features these methods are trying to control. A review of the current knowledge related to the perception of low frequencies has been given.

This review forms the basis for the subjective studies carried out in this thesis and guides in the design of experiments to gather further knowledge in those areas where it is needed. A research gap has been identified as a lack of specific studies that investigate the various subjective effects caused by resonances in the specific context of critical listening rooms.

3 Sound Fields in Enclosed Spaces

3.1 Introduction

It was introduced in Chapter 1 that *room modes*, are recognized as one of the most noticeable problems in professional audio control rooms. Although this problem is widely acknowledged, efficient solutions are still difficult to implement. This issue is made worse by the fact that modal resonances are a greater problem in smaller rooms, where the necessary space to correct them using conventional passive absorption methods is not available.

In order to understand the implications of room modes on subjective perception, a thorough knowledge of the behaviour of sound in the room, and more specifically the factors associated with resonances, is necessary. The work in this thesis concentrates on the problems experienced in the reproduction of the low frequency range, given that this is still a particular problem that is encountered in many professional facilities. This chapter presents a review of suitable prediction models for the low frequency response in rectangular rooms. This is given in the form of a wave solution for a sound field in a three-dimensional enclosure with rigid boundaries. A definition of source shape function is introduced. Sources are derived and modelled as an ideal *point* (Kuttruff 2000) and as a *rectangular piston* (Bullmore 1987).

The enclosures studied and described in this chapter are rectangular and generally assume low damping at low frequencies. This implies simplifications on the analytical expressions and enables a clearer analysis simple enough to enable the introduction of more complex types of sources, as those studied in Chapter 5.

The review of theory presented here aims to provide an understanding of the underlying mechanisms of resonances in enclosed spaces. This knowledge is important for a clear appreciation of objective factors characterising the response in the room and their influence on subjective perception. The study of more complex type of sources in Chapter 5 is also dependent on knowledge gathered from the theory reviewed here.

3.2 Rectangular room with hard walls – modal theory

An enclosed space may be considered as an important part of the transmission system between a source and a receiver position within it. It is desirable, for many acoustic applications, that this enclosed space transmits all frequencies equally well and that its characteristics do not colour the original sound wave. It is well known, however, that any enclosed space actually superimposes its own characteristics on the transmission of sound. The task of designing a room

that allows the accurate reproduction of sound is therefore associated with the control of the shape and acoustic impedance of the surfaces, such that sound transmission is as uniform as possible across the audible frequency range, both in the forced and natural decay responses.

Morse (Morse 1948) describes a room as ‘an assemblage of resonators’. At all frequencies where the room dimensions are an integer multiple of the wavelength, a resonance will be excited. These standing waves are usually called *room modes* and the frequency of resonance for each mode is termed *eigenfrequency*. The eigenfrequencies in a room may be determined by (Kuttruff 2000):

$$f_{n_x n_y n_z} = \frac{c}{2\pi} k_{n_x n_y n_z}$$

Equation 3.1

where

$$k_{n_x n_y n_z} = \pi \left[\left(\frac{n_x}{L_x} \right)^2 + \left(\frac{n_y}{L_y} \right)^2 + \left(\frac{n_z}{L_z} \right)^2 \right]^{1/2}$$

Equation 3.2

represents the three dimensional wave number, and n , representing the mode order, takes integer values from 0 to infinity. The indexes x , y and z represent the three spatial dimensions of the room and L is the length in meters for each dimension. If all indexes of n take non-zero values, a mode is excited between two opposite corners (or a group of three surfaces). This is usually described as an *oblique mode*. When one of the mode orders (e.g.: n_z) is equal to zero, the mode is excited between two opposite pairs of surfaces and is called a *tangential mode*. If only one of the mode orders takes a positive value, the propagation of the wave appears between parallel sets of walls. This case is termed an *axial mode*. It is generally accepted that the energy of the modes depends on the losses associated with each of the reflecting surfaces involved. Therefore, on a descending order of energy, axial modes are stronger than tangential modes, which are stronger than oblique modes. In real applications, this depends on the effective absorption at each surface.

The analysis of the sound field in small rooms may be divided into two major areas (Morse 1948).

At high frequencies, the wavelength is small compared to the room dimensions. The number of possible modes, excited by a wide band signal at any point in the room, is high and their density increases with frequency. A source within the room will couple to and excite multiple resonances. During the forced response, while the source is radiating, the sound field is composed of the addition of the many standing waves that the room supports. The spatial

variation of pressure may be assumed to be generally constant given that there is interaction between many resonances. In its natural response, one may assume a regular decay over a large bandwidth, resulting from similar decay values for each resonance. This decay time is directly associated with the absorption characteristics of the materials in the room, and given the comparatively short wavelength, control over a wide bandwidth is possible with simple absorption. The overall response in the room may be analysed using statistical methods, which assume the sound field becomes diffuse after a number of reflections from the walls. Under these conditions it is acceptable to assume constant energy density throughout the sound field and equal probability in all directions of propagation.

At low frequencies, the assumption of a diffuse field in the room is not satisfied. Associated with each mode, there are areas of maximum (peaks) and minimum (nodes) pressure. For a single mode, this pressure distribution may be referred to as a *mode-shape* or standing wave. Depending on its position, a source radiating sound at wavelengths comparable to the room dimensions will excite only a few modes, well separated in frequency. This will impose a modification of the sound near the eigenfrequencies. The extent to which a bandwidth near an eigenfrequency is affected depends on the damping conditions in the room at these frequencies. Lightly damped modes affect a narrow bandwidth but have very long decays that linger after the removal of the driving signal. The decay of sound at such low frequencies is therefore dependent on the decay rates of these modes. Given that the amount of effective low frequency absorption present in rooms is very small, the frequency of each mode will ‘resonate’ in the decay portion of the sound affecting its correct reproduction.

Schroeder et al. established the division frequency between the diffuse and modal fields in the study of rooms (Schroeder et al. 1962). This is based on the assumption that individual resonances are indistinguishable when the frequency separation between them is smaller or equal to the bandwidth of resonance. It can be shown that this depends on their decay rate, given that it is proportional to the inverse of the bandwidth. The Schroeder frequency is thus defined as follows:

$$f_s = 2000\sqrt{\frac{T}{V}}$$

Equation 3.3

Here, T , given in seconds, is defined as the ‘reverberation time’, and depends on the damping, δ , associated with the frequency in question:

$$T = \frac{6.91}{\delta}$$

Equation 3.4

The room volume, V , is given in cubic metres.

The definition of this frequency limit on a certain number of modes per bandwidth is perhaps a little arbitrary and indeed other suggestions have been made to include up to five modes per bandwidth suggesting a more reasonable change over frequency (Walker 1992).

The model presented here for the study of sound below the Schroeder frequency utilises a *modal decomposition* technique, where the pressure at a point is defined as a summation of the contributions of all modes supported by the room dimensions. The room is modelled as a rectangular enclosure. In practice, real rooms will, of course, differ from this simple model. However, at such low frequencies, most small rooms may be accurately represented by a cuboid, especially when the features and furniture in the room are small compared to the wavelengths of interest (Maluski 2004). Other more complex cavities are known to result in different modal pressure distributions. However, even in complex rooms most of the modal characteristic behaviour, such as the increase of density with frequency, is still maintained (Angus 1999).

The model assumes rigid boundaries and results will substantially deviate from the real conditions if the damping in the room at the frequencies of interest is very large. This fact is associated with the mode-shapes being modelled as *cosine* waves that fit within the physical dimensions of the room. For rooms with light walls, the impedance at the boundaries can no longer be assumed to be infinite and the mode-shape diverges from a simple cosine.

Two types of sources of acoustic damping are commonly found in real rooms. In most rooms and at very low frequencies even the most common type of wall construction (brick or reinforced concrete) will vibrate, presenting some damping and removing some energy from the modes. This is included in the prediction model in the form of very low damping, which prevents an infinitely large value for the magnitude of pressure at resonance. Another source of damping emerges from the considerable amount of porous or bulk absorption found in most critical listening rooms, especially in the case of audio control rooms. This absorption is usually effective from frequencies above around 300 Hz due to the constraints of achieving efficient low frequency absorption in a limited space. Hence, in the modal region (generally below 200 – 300 Hz) the effect of porous absorption is usually very small. Consequently, the amount of damping present in the modal region originates mainly from wall vibration. Hence, the predictions from the model presented can no longer be considered accurate if the room deviates substantially from rigid walls.

3.2.1 No source

The theory for the sound field in an enclosed space is clearly presented by Morse (1948) and Kuttruff (2000) among others. This will be described briefly in order to introduce the model used to investigate the interaction between source and room.

The wave equation has the following form:

$$\Delta p + k^2 p = 0$$

Equation 3.5

Where Δ is the Laplacian transformer and k is the wave number.

Often a good approximation is to assume that the walls are locally reacting. Hence, its acoustical properties may be described by impedance at the boundaries that is frequency dependent.

At the boundaries of the room, here described in Cartesian coordinates $x=0$ and $x=L_x$; $y=0$ and $y=L_y$; $z=0$ and $z=L_z$, the normal component of the particle velocity vanishes. The wave equation may be rewritten in terms of its three dimensions:

$$\frac{\partial^2 p}{\partial x^2} + \frac{\partial^2 p}{\partial y^2} + \frac{\partial^2 p}{\partial z^2} + k^2 p = 0$$

Equation 3.6

This may then be solved for each orthogonal dimension:

$$\frac{\partial^2 p_1}{\partial x^2} + k_x^2 p_1 = 0 \quad \text{and}$$

$$\frac{\partial p_1}{\partial x} = 0 \quad \text{for } x=0 \text{ and } x=L_x.$$

Similar result applies to the other Cartesian coordinates. A general solution for Equation 3.6 takes the form:

$$p_1(x) = A_1 \cos(k_x x) + B_1 \sin(k_x x)$$

Equation 3.7

However $B_1 = 0$, as only the *cos* term allows a non-zero value at $x=0$ and $x=L_x$. Therefore $\cos(k_x L_x) = \pm 1$, ensuring maximum pressure conditions at the boundaries of the space.

The solution eigenvalues take the form:

$$k_x = \frac{n_x \pi}{L_x}$$

and subsequently for the other axes,

$$k_y = \frac{n_y \pi}{L_y}$$

$$k_z = \frac{n_z \pi}{L_z}$$

where k_x , k_y and k_z refer to the wave number associated with each dimension.

$$\text{So } p_n(\bar{r}) = C \times \cos\left(\frac{n_x \pi x}{L_x}\right) \times \cos\left(\frac{n_y \pi y}{L_y}\right) \times \cos\left(\frac{n_z \pi z}{L_z}\right)$$

Equation 3.8

where \bar{r} represents the position vector in the x, y, z space. C is an arbitrary constant.

Equation 3.8 represents a three-dimensional standing wave in the room commonly referred to as a room mode. The coefficients n_x , n_y and n_z are non-negative integers and represent the mode order. The factor $e^{j\omega t}$ introduces the time dependence and completes the expression.

The resulting pressure is zero every time one of the \cos factors is zero. In rectangular rooms, this represents a nodal plane (zero pressure) and is found at odd integer multiples of $L_x/2n_x$ (and analogous values for y and z).

3.2.2 Source excitation

So far the derivation has been carried out for the wave equation with no source in the space (Equation 3.5 equals zero). In order to introduce a source into the model a source shape function must be determined.

A source function $q(\bar{r})$ is defined. The wave equation is then modified to

$$\Delta p + k^2 p = -j\rho\omega q(\bar{r})$$

Equation 3.9

It can be proven that the eigenfunctions form an orthogonal set of functions such that

$$\iiint_V p_n(r)p_m(r)dV = \begin{cases} X_n, n = m \\ 0, n \neq m \end{cases}$$

Equation 3.10

The triple integral represents the volume integral, and X_n is a scalar that depends on the volume and the admittance at each set of parallel surfaces in the room.

The source function in this case may also be represented by an expansion series of p_n .

$$q(r) = \sum_n C_n p_n(r)$$

Equation 3.11

where

$$C_n = \frac{1}{X_n} \iiint_V p_n(r) q(r) dV$$

Equation 3.12

So C_n is defined as the volume integral of the source, multiplied by the receiver shape functions defined in Equation 3.8.

Finally the pressure at a receiver position r may be defined as

$$p_\omega(r) = \sum_n D_n p_n(r)$$

Equation 3.13

where D_n may be obtained by solving for the known C_n , defined in Equation 3.12, and the following form of the wave equation:

$$\sum D_n (\Delta p_n + k^2 p_n) = j\omega\rho \sum C_n p_n$$

Equation 3.14

From Equation 3.5, $\Delta p = -k^2 p_n$, therefore

$$D_n = j\omega\rho \frac{C_n}{k^2 - k_n^2}$$

Equation 3.15

where C_n is defined in Equation 3.12.

3.2.2.1 Point source

The end of the previous section defines the frequency dependent pressure at a point in the room. This equates into a product of a source shape function D_n and a receiver shape function p_n .

For the ideal case of a point source

$$q(\vec{r}) = Q\delta(\vec{r} - \vec{r}_0)$$

Equation 3.16

where Q is the source strength factor and δ represents the delta function. This defines the source as a single discrete point in the room at position \vec{r}_0 .

From Equation 3.12,

$$C_n = \frac{Q}{X_n} \iiint_V \delta(\vec{r} - \vec{r}_0) p_n(\vec{r}) dV$$

Equation 3.17

and applying the sifting property

$$C_n = \frac{Q}{X_n} p_n(\vec{r}_0)$$

Equation 3.18

Subsequently,

$$p_n(\vec{r}_0) = \cos\left(\frac{n_x \pi x_0}{L_x}\right) \cos\left(\frac{n_y \pi y_0}{L_y}\right) \cos\left(\frac{n_z \pi z_0}{L_z}\right)$$

Equation 3.19

which defines the source shape function for an ideal point source.

The equation that defines the pressure at any point in the room when subject to excitation from a point source is now,

$$p_\omega(\vec{r}) = j\omega\rho Q \sum_n \frac{p_n(\vec{r}) p_n(\vec{r}_0)}{X_n (k^2 - k_n^2)}$$

Equation 3.20

This is known as the Green's Function for the system and represents the transfer function between source and receiver.

If complex boundary conditions are defined, then the wave number may take complex values,

$$k_n = \frac{\omega_n}{c} + j \frac{\delta_n}{c}$$

Equation 3.21

Here ω_n , c and δ represent the resonant angular frequency, speed of sound in the medium and acoustic damping, respectively. The acoustic damping term may be defined from a figure for the reverberation time as shown in Equation 3.4.

Equation 3.20 transforms into

$$p_\omega(r) = j\omega\rho Qc^2 \sum_n \frac{p_n(r)p_n(r_0)}{(\omega^2 - \omega_n^2 - 2j\delta_n\omega_n)X_n}$$

Equation 3.22

with $\delta_n \ll \omega_n$. The resonant term $\omega^2 - \omega_n^2$ becomes very small as the driving frequency ω approaches the resonant frequency of the system ω_n . This results in the infinite rise of pressure at resonance. The damping term keeps the expression finite at resonance.

Equation 3.22 predicts the pressure variation with frequency for any defined source-receiver relationship in the room. This expression will form the basis for the investigation model. This model is usually referred to as a *modal decomposition*, defining the pressure at a certain point in the room as the sum of the contributions from each mode. The inevitable truncation of the number of modes in the computation influences the accuracy of the model. It is known that because of their lower level residues, higher order modes (higher in frequency) will exert less influence on the response at low frequencies. Therefore, truncation may be applied to a specific number of modes with little consequence for the predictions at low frequencies. The model includes modes in which n_x , n_y and n_z take values up to 15. The most common frequency range used throughout this thesis is 0 to 200 Hz.

The predictions were carried out using models written in MATLAB code.

Figure 3.1 shows a measurement of the transfer function in a lightly damped room (reverberant chamber) that is used to validate predictions using the derived model. The measurement was carried out using a standard procedure based on a dual FFT analyser. Details of room measurements are presented in Appendix II.i. The measured values are contrasted with the prediction model for a point source determined by Equation 3.22.

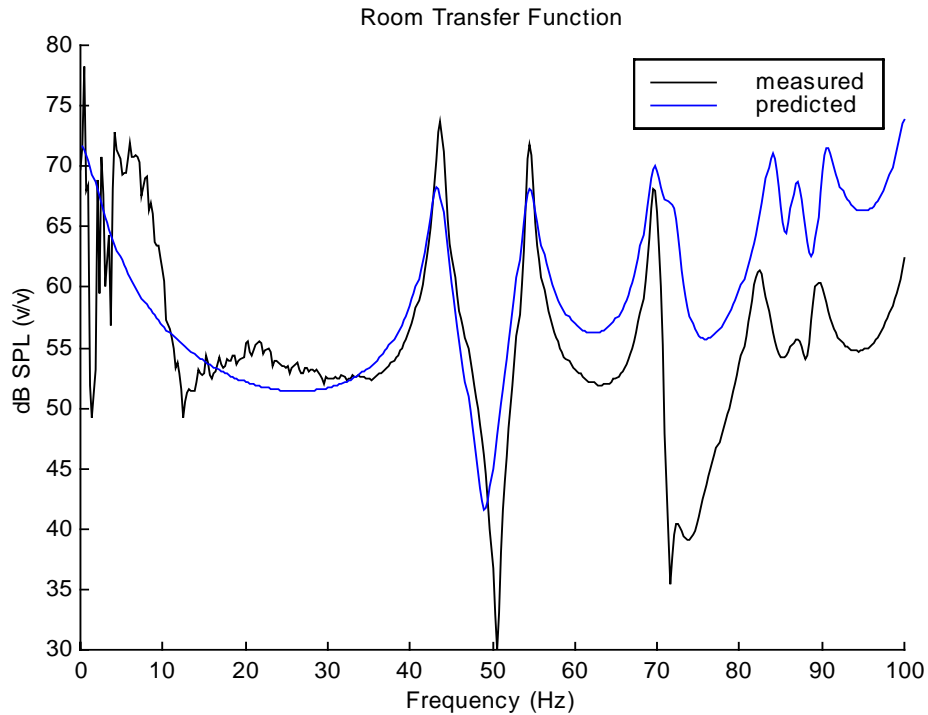

Figure 3.1 –Measured and predicted magnitude frequency responses for an ideal point source in a room. Measurement using a large 0.05 m^2 cone loudspeaker.

The model is shown to be accurate at the lower order modes, although the higher Q-factor observable on the first two measured modes indicates that at this frequency the damping in the room was lower than that used in the model. At higher frequencies the matching is not as good, as the model over-predicts pressure levels by about 15 dB, and the residual interaction between modes, specifically between the 69 Hz and the 72 Hz modes, is different. These differences are typical of a shift of position between source and room mode-shape. The origin of these errors appears to be associated with the fact that the model describes the room as rectangular in shape, whereas the real room has one surface that is not rectangular. One of the corners of the reverberant chamber used for measurements is slanted to provide higher diffusion. While this is unlikely to change the general low frequency characteristics in the room (modal distribution, damping), it does affect the spatial pressure distribution, especially at higher frequencies where the wavelength is shorter.

In addition, the model assumes constant damping with frequency. As mentioned before, it is determined from a figure for the reverberation time in the room (Equation 3.4). In real situations, damping is expected to increase with frequency, increasingly affecting the Q-factor of higher order modes. Analysis of the above response does show some evidence of this where the higher ‘measured’ modes appear to have a slightly larger bandwidth. The emphasis of this section is on determining a model that may be used to predict general sound fields in rectangular rooms. For this, it is important that the model provides acceptable information on the interaction of critical factors such as damping, room aspect ratios and source coupling. Therefore a total match between model predictions and measured is not considered essential as

long as the model is suitable to describe the general characteristics of the behaviour of modal sound fields. The model derived here may be used to study the effects of source and receiver placement as well as be the basis for modelling room behaviour for non-ideal sources such as rectangular pistons and distributed sources. This will allow a general study on source and room interaction as is presented in Chapter 5. In addition, this model will also be used for a study on the effects of room aspect ratios on the subjective perception of low frequencies, presented in Chapter 6.

3.2.2.2 Rectangular piston

The ideal point source defined in the previous section is sufficient to describe the radiation of low frequency sources in the room. However, in order to define more complex sources of a distributed nature, the definition of the source should have closer characteristics to ‘real’ sources with a limited physical size.

The definition for the response of a rectangular piston in a room requires the derivation of a source shape function to represent the new type of source in the model. Bullmore has derived the source shape function for a rectangular piston in an application for noise control (Bullmore 1987).

New expressions for a rectangular piston have been derived for the work presented in this thesis. These are presented here. From Equation 3.12, C_n is defined as the volume integral of the receiver shape function multiplied by an analytical definition of the source. This results in an expression for the source shape function that can be used in the model. For a rectangular piston, the source in the room is defined as an infinitely thin panel with finite dimensions. For the present model, the source is assumed to be parallel to one of the walls in the room. In addition, the source position will always be defined at one of the walls, such that only front radiation is considered. This excludes many real situations but reduces considerably the complexity of the analytical expressions. In terms of the study presented here, this derivation is sufficient, as all modelled cases will employ sources at the boundaries. For the following derivation, the rectangular piston is assumed to be parallel to the pair of walls $x=0$ and $x=Lx$. C_n now takes the form:

$$C_n = \frac{Q}{X_n} \iiint_V \delta(x - x_0) |1 \cos(k_{n_x}) \cos(k_{n_y}) \cos(k_{n_z})| dV$$

Equation 3.23

The piston boundaries are defined as:

$$x = x_0,$$

$$y = y_1 \text{ and } y = y_2,$$

$$z = z_1 \text{ and } z = z_2.$$

Figure 3.2 represents the plate in the room, along with the positioning coordinates.

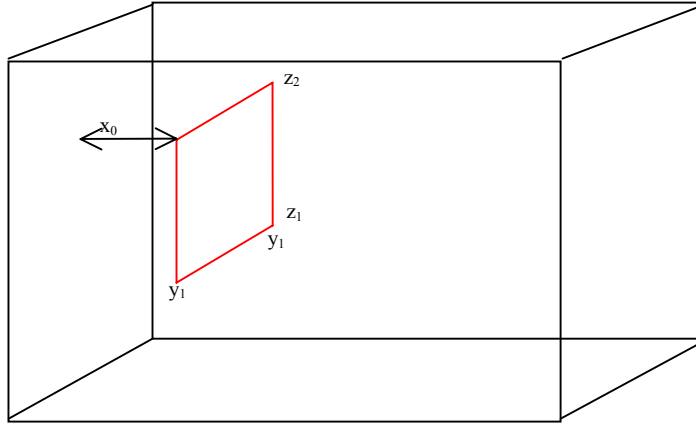

Figure 3.2 – Definition of the coordinate system for a rectangular piston in a room. The coordinate x_0 is magnified for illustrative purposes. In the modelled situations $x_0=0$.

The piston is therefore defined at a single point in the x dimension and between two points in the y and z dimensions. The limits of the integrals may then be applied:

$$C_n = \frac{Q}{X_n} \int_0^{L_x} \int_{y_1}^{y_2} \int_{z_1}^{z_2} (\delta(x - x_0) \cos(k_{n_x} x) \cos(k_{n_y} y) \cos(k_{n_z} z)) dx dy dz$$

Equation 3.24

The resulting source shape function for a rectangular piston in these conditions is given by:

$$\Psi_{piston} = \frac{1}{k_{n_y} k_{n_z}} \cos(k_{n_x} x_0) [\sin(k_{n_y} y_2) - \sin(k_{n_y} y_1)] [\sin(k_{n_z} z_2) - \sin(k_{n_z} z_1)]$$

Equation 3.25

with the following alterations for singularity cases,

$$\Psi_{piston} = \frac{1}{k_{n_z}} \cos(k_{n_x} x_0) [(y_2) - (y_1)] [\sin(k_{n_z} z_2) - \sin(k_{n_z} z_1)]$$

Equation 3.26

when $k_{n_y} = 0$ and $k_{n_z} \neq 0$. The inverse case is obtained by swapping z with y .

Finally,

$$\Psi_{piston} = \cos(k_{n_x} x_0) [(y_2) - (y_1)] [(z_2) - (z_1)]$$

Equation 3.27

when $k_{n_y} = k_{n_z} = 0$.

The full derivation of these expressions may be found in Appendix III.i.

The prediction results for a rectangular piston in a room may be compared to measurements presented previously for a loudspeaker in a lightly damped room. Figure 3.3 shows the case where the rectangular piston is modelled in an identical position in the room, with a radiating area similar to that of the loudspeaker cone.

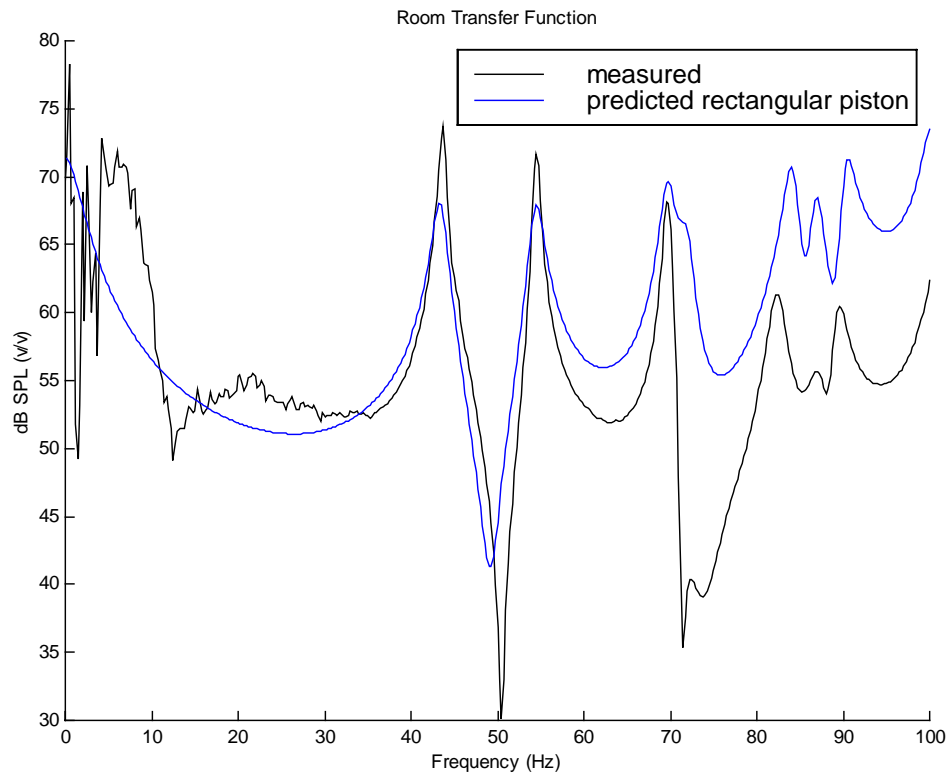

Figure 3.3 – Magnitude frequency room response in the room. Comparison of measured data with a closed box loudspeaker to predicted values for a rectangular piston of the same area.

The radiation behaviour of a finite piston source in an enclosed space is expected to be similar to that of a point source if the receiver location is sufficiently distant from the source position. As shown, the response modelled with a rectangular piston of the same area predicts a response with similar characteristics to those measured in the room. Indeed the errors are similar to those obtained using an ideal point source, reinforcing the idea that the differences may be associated with a mismatch in the measured sound field rather than any analytical errors.

The accuracy of the model presented here is dependent both on the number of modes included in the summation (Equation 3.22) and the type of source modelled. The introduction of novel expressions for a piston plate not only permit the derivation of a numerical method to evaluate more complex distributed sources but also allow more accurate predictions using a smaller number of modes in the room model.

The differences between an ideal point source and a rectangular piston become evident when the receiver position is set closer to the source. If the pressure is calculated very close to the source there will be some differences associated with convergence issues related to the dimensions of the source. Figure 3.4 shows a case where the room response is predicted for a receiver position set at 5 cm in front of each source.

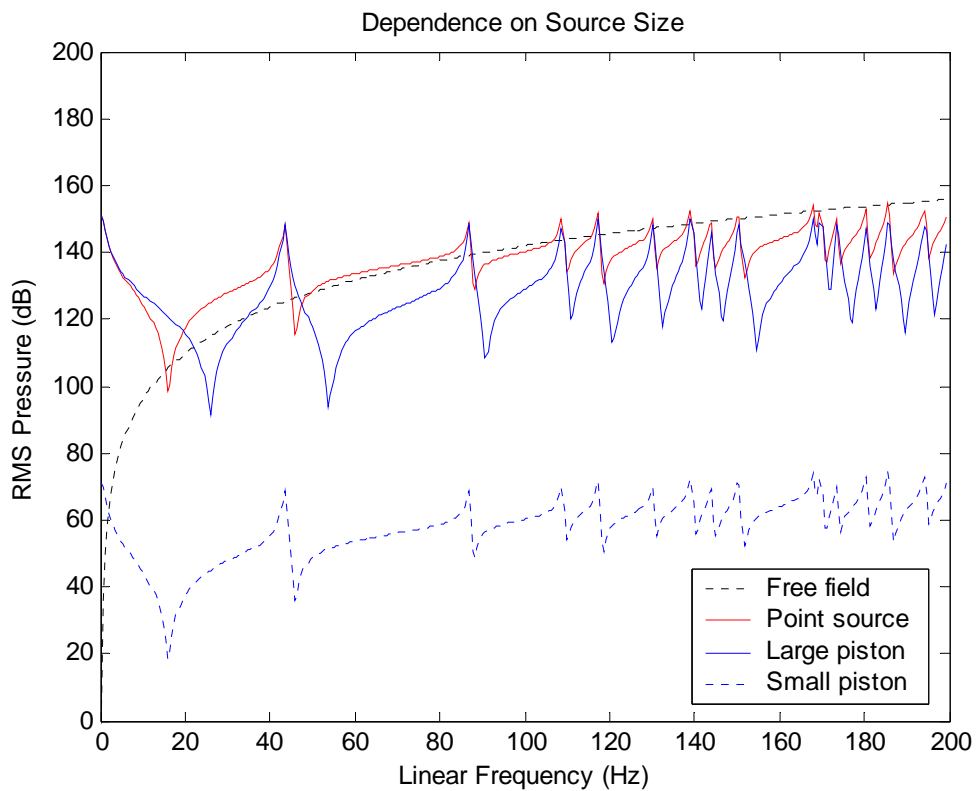

Figure 3.4 – Convergence with distance for modelled point and rectangular piston source. For very small distances the results for point source (solid red line) converge to free field radiation (dot dash line). A large rectangular piston (solid blue line) still produces large amplitude variations, whilst a small piston (dashed blue line) has similar characteristics to a point source.

For infinitely small sources, such as the ideal point source, the predicted response in the room should converge to a line that approaches spherical radiation into free space following the $p \cong j\omega\rho Q/(4\pi r)$ curve (black dotted line). The red line in Figure 3.4 shows the response predicted at 5 cm from an ideal point source. This behaviour is expected because as the effects of the room become less noticeable, the radiation of the source becomes prevalent and should converge to free field radiation. However, total convergence is not obtained. In order to model

this convergence with an ideal point source, it would be necessary to include an infinite number of modes in the summation. These results show a summation up to 15 modes.

On the other hand, the response of a 1 m^2 rectangular piston (solid blue line) predicted at the same distance still shows peaks and dips largely due to the distributed nature of the source. As a large radiating surface, each infinitely small area of the plate will be responsible for some radiation. At low frequency the interaction between the set of elemental radiators and the room mode shapes responsible for sound radiation is straightforward. At high frequencies the panel is large compared to the spatial mode-shape variability and so high order mode shapes tend to cancel each other in the modal summation. The lack of coherent high frequency modal residues leaves the low frequency pressure variance larger than that obtained for a smaller radiator. If the size of the plate is drastically reduced, the radiation will once again approach point source conditions and the room effects will decrease. The response of a small (1 cm^2) piston is also shown in Figure 3.4 (blue dashed line). The reduced amplitude is a direct implication of the smaller radiating area for the same source strength. It is shown that when the source is reduced, the pressure variation is less pronounced and the response converges to free field radiation.

3.3 Summary

This chapter presented the derivation of a model for the study of low frequencies in lightly damped rectangular rooms. The model is presented using the common modal decomposition technique. Derivations are introduced for a point source and a novel solution for a rectangular piston plate.

Prediction results are compared to measurements in a real room. It was found that as the frequency increases, the predictions diverge from the measurements. These deviations are attributed to discrepancies between the actual measurement conditions and the model, rather than analytical errors. Overall the prediction results are approximate enough for the purpose of studying modal sound-fields and the effects that source type and source placement may exert on these.

It is shown that the accuracy of the models is dependent on the type of source used. An ideal source such as a point source, while sufficient to model sound-fields where the source is distant from the receiver location, is inexact in the prediction of a sound field very close to the source. It is shown that the inclusion of a model for a piston source allows determination of sound fields with a relatively low number of modes in the model. The introduction of a solution for a rectangular piston plate will also allow the study of distributed types of sources, and as will be shown in Chapter 5, will prove an important tool for the modelling of distributed mode vibrating plates.

The model derived here will also be employed in Chapter 6, where a subjective study on the perception of modal distribution is presented.

4 Preferences and Views of Control Room Users – a Qualitative Study

4.1 Introduction

It has been shown in Chapter 2 that the problems created by room modes have been thoroughly investigated from a physical point of view, and that many solutions have been developed in an attempt to control them (e.g. Welti and Devantier 2003; Makivirta et al. 2003). Chapter 3 describes the mechanisms underlying this problem in rooms, and the models presented successfully illustrate it from a physical standpoint.

Despite the large number of solutions proposed, there is a lack of empirical evidence identifying if the problems caused by room modes are still perceived in critical listening spaces. Indeed, persistence of the problem has been referred in some studies (e.g. Newell et al. 1994; Makivirta et al. 2003), but these have no substantial basis on empirical evidence.

This chapter qualitatively identifies the problems generated by the perception of room modes in professional control rooms. Its results demonstrate this to be a persistent problem, indicating a shortcoming in the current knowledge, which has focused mainly on objective parameters to the expense of subjective perception. This has so far prevented better guidance in creating subjectively efficient solutions, and justifies the need for the subjective investigations carried out in Chapters 6, 7 and 8.

The experience of professionals working in audio control rooms is valuable and holds important information on myriad problems that may be common across the industry. Hence, a set of semi-structured interviews has been carried out in order to gather factual information from professionals. The aim was to identify common problems in control rooms that may hinder its performance as perceived by users. The data gathered was analysed and common themes emerged describing major problem areas and their implications at a high standard professional level.

4.2 Research technique

The most common of all qualitative methods is that of interviewing (Easterby-Smith et al. 2002). This approach allows the identification of a rich account of the interviewee's experiences, knowledge and impressions. Furthermore, interviews provide an opportunity to uncover new dimensions of a problem through accounts based on personal experience (Easterby-Smith et al. 2002).

In this research a semi-structured interview approach was adopted. This type of interviews have predetermined questions, but their order can be modified allowing a general focus with sufficient flexibility to explore issues that may emerge during the discussion. The interviews aimed at identifying carefully selected aspects of sound in audio control rooms, and the outcomes of work carried out in them.

An interview pro-forma was developed and applied to all interviews (Appendix I.ii). The questions included various factors that are known to affect the way sound is perceived in enclosed spaces, e.g. reverberation, frequency balance and consistency with other environments. In order to reduce effects of issues such as poor recall and to allow a more detailed analysis, all interviews have been recorded and verbatim transcribed. An example of an interview transcript is presented in Appendix I.iii.

Eighteen professionals, all working in purposely-built recording, mastering or broadcasting control rooms participated in the interviews. The average working experience was around ten years and no less than one year. Fifteen of these professionals worked in recording or mastering, two professionals worked in live recording of classical performances and one professional worked in broadcast for a major British broadcast company. The range of musical styles involved was varied and included classical, pop, rock and dance. The interviews lasted between thirty minutes and one hour.

The data analysis focused on identifying common themes throughout the interview transcripts. The implications of these with regards to the reproduction of low frequencies were then explored. All themes are interrelated and describe issues that affect the performance of work carried out in critical listening rooms. 'Optimum' settings for the factors under focus in the interview are assumed to describe acoustic conditions that provide the user with a perception of the sound being reproduced which is comfortable and unhindered by perceptible problems.

The next section presents the data analysis. Appropriate quotations are given to reinforce important points. The quotations, when presented, are representative of the general idea from the group regarding different acoustic features.

4.3 Analysis and discussion

This section presents common themes identified in the interviews, their relation to the reproduction of low frequencies and the consequences on the work carried out in the rooms.

The group of professionals interviewed was asked to comment on various factors that affect their performance in a control room. They were encouraged to report not only on their

preferences about these factors, but also on any annoying problems and how these hinder their performance in the working environment.

Reverberance is a widely used descriptor of the acoustic quality of rooms and relates to the temporal decay of sound in them. The levels of reverberance for critical listening rooms have been defined in published recommendations and depend to some extent on the type of material that is being monitored (IEC 268-13 1985).

When commenting on the preferred levels for reverberance in a control room, most subjects reported that room reverberance and reflections are factors that should be kept at a minimum and not perceptible in the monitoring environment, as an excess of reverberation may hinder the correct judgement of sound. This is conveyed by the following remarks: *“I’d prefer a dry room”*; *“I think the room should be neutral in the sense that you shouldn’t be aware of it.”*

However, some users object to environments with very low reverberation times and these are commonly reported as uncomfortable. As follows: *“I find dead rooms very tiring...”*; *“I think a completely dead room is very claustrophobic.”* Some room ambience, which gives the user some perceptual clues of the enclosed space, is important for comfort and indicative of the end-user’s environment. Hence, *“you need a room to be slightly reverberant because the end listener, the person in the living room at home has a reverberant room.”* Also at low frequencies, long decays (or reverberance) will be noticed by the listener and therefore hinder the correct perception and qualitative judgement of the sound being monitored.

Throughout the interviews it became increasingly evident that there is a major problem at low frequencies with control rooms, with all interviewees reporting it. The degree of uncertainty caused by the low frequency problems is clear in the following quote: *“There’s something in the walls that causes the bass to boom and reverberate and do strange things.”*

Furthermore, there is a general idea that noticeable spatial irregularities of sound in the room appear mostly at low frequencies. This is reported in comments such as: *“The main problem I think that we have with this room is the bass response of the room which changes drastically depending on where you sit.”* This problem affects the usable listening area in the room, limiting the number of users that may obtain an accurate perception of the reproduced sound. Furthermore, this may have repercussions on the commercial suitability of a certain room as it affects the performance as perceived by customers. This is conveyed by the following remarks: *“[The problem] is reasonably important because it gives the people you’re working with a wrong impression, because generally they’re not sitting at the desk all day”*; *“it has to sound good everywhere in the room because band members aren’t going to come up ... and make sure they’re sat in the right place.”*

The problem of spatial variation of sound quality caused by room modes also affects the ability to perform monitoring tasks away from the main listening position. Adjustments on outboard equipment, usually positioned away from the listening position, force the user to move to perform the adjustments and return to the optimum listening position to judge the result. Therefore, *“You must sit in the operating position in the room to do any serious work.”* This is clearly far from desirable in a situation where concentration is required and time constraints demand prompt actions.

This reported spatial change of perception may be explained by the well known spatial variations of pressure caused by standing waves at the room's eigenfrequencies. This pressure distribution associated with each room-mode is commonly referred to as a *mode-shape*.

The issue of room modes has also been reported in connection with alterations in the perception of transient sounds in the room. Furthermore, these temporal alterations are also reported to be location dependent, as in: *“There's always a change in the frequency response, the transient is different depending on where you are you know. I think the bigger the neutral space that can be created the better.”* These alterations imparted to the response of transients in rooms are caused by the long natural decays of under-damped resonances. The temporal relationship between room resonances and their decays are well known and have been documented by Makivirta et al. (2003) for example. A study of its effects on the subjective perception of low frequency sound is presented in Chapters 7 and 8.

In most control rooms it is common to find a second set of monitor speakers, which are used as a comparison to the main monitoring system. These are commonly referred to as near-field⁵ monitors given that they are placed closer to the listener. Near-field monitors are critical when performing long hours of work, and they are chosen over the main monitors. *“Virtually all the mixing and the long hours of programming and working are done on the near fields.”* One of the main reasons reported for the use of ‘near-fields’ is a restricted frequency response facilitating a monitoring sound quality which is closer to that found in common domestic systems, as reported in: *“It's just because they're more like hi-fi speakers really”*.

Another common factor reported to affect the choice of monitors used is the variation of perceived sound quality between different control rooms, as referred in the following: *“...that's partly because with the variation in rooms and the variations in monitors there is a much bigger variation between if you go from one room to another room to another room, there's a much bigger variation in the big monitors, the main monitors than there is in the near fields...”* Furthermore,

⁵ Near-field monitors are high-quality small speakers with a restricted frequency response that is a better match to the end users type of speakers. Near-field monitors are usually brought into a room to provide the user with a different set of speakers for comparison

some professionals report taking their own, 'recognisable' set of speakers as an assurance of consistency between rooms.

This reported variation in sound quality is associated with the fact that main-monitors, which have an extended low frequency response, tend to excite more of the low frequency range and therefore reveal more of the modal response that is characteristic to each room. Near-field monitors, on the other hand, have a limited low frequency response, which limits the extent to which some of the lower frequency modes are excited. However, the positioning in the room of each type of monitoring system is also a critical factor in the low frequency sound quality. An important reason for using *near* field monitors is that their placement close to the listener increases the direct to reverberant ratio, therefore reducing the room environment as perceived by the listener. In contrast, the fact that many professional control rooms are designed to be used with specific main monitors, usually flush mounted on the front wall, and most work is done with another set of speakers, usually placed on or near the mixing desk, means that the listener may not be taking the full advantage of the intended acoustic performance of the room. Due to their different positioning, the additional near-field speakers will couple to different mode-shapes, and the room response will differ from that obtained with the main monitors. Although their low frequency extension is restricted, in smaller rooms, near-field speakers may still cause audible inaccuracies that will be different from room to room. Indeed, the modal sound field of different rooms, will certainly be different to that intended by the designer if there were considerations regarding the dimensions of the room and the consequent modal distribution.

All users reported undergoing through a stage where they adapt to how a certain room sounds and how this affects their perception of the sound in that room. This is usually achieved by playing some well-known recordings and also by identifying problems in the finished work when replayed in other systems and/or environments. This procedure becomes a learning process that, when perfected, enables final work to sound consistent across multiple systems and similar to how it was intended in the control room. During this process, part of the lower frequency inaccuracies of a certain room-speaker combination are revealed to a critical listener, and some adaptation is possible. However, some reports have shown that for some rooms, and even after a learning process that may allow some adjustment of low frequency level, the transient behaviour of sound at low frequencies will still be affected by the problem of resonances and the necessary certainty for accurate judgement is not possible.

4.4 Summary

This chapter has presented the results of a survey carried out on a group of professionals that work in control rooms for audio production. The lack of empirical evidence and the extent of

the problem formed the requirement for a more rational basis for the study of the problem in both subjective and objective fields.

The results of this survey concerning the problem of room modes have been highlighted and where appropriate, quotations from the interviews were included to convey more precise opinions about the problem.

It has been empirically demonstrated that the problems associated with room resonances, as perceived by listeners, still persist in most of the rooms where the interviewees operated. The implications of room modes on the performance of control rooms have been conveyed by consensus of individual experiences. More specifically the problems of room modes have been described as:

- Creating long low frequency decays.
- Altering the perception of transients.
- Causing perceptible frequency imbalances.
- Causing imperceptible frequency imbalances that induce consistent monitoring errors directly associated with an over- or under-emphasis of certain frequency ranges in a specific room.
- Causing large variations of the sound quality within the room.
- Leading to excessive reliance on smaller, frequency restricted monitors that are placed on or near the mixing desk, leaving part of the frequency range unmonitored, and further compromising the original acoustical design of the room.
- Causing uncertainty about how the overall sound quality will vary when the work is listened to in other environments.

All the above are issues that, if left un-addressed, will severely hinder the performance of professionals using these rooms and possibly translate into poorer quality final products being passed onto the consumer market.

If these professionals, that develop multiple tasks in a wide variety of control rooms with a range of music styles, are assumed as a representative sample of the industry, it is clear that the state-of-the-art knowledge on the subject of room design, and more specifically, of low frequency control, is deficient in providing efficient solutions for accurate reproduction rooms. Given that many control techniques have been developed and are available, one of the reasonable explanations for this failure in creating high quality rooms is a shortcoming in the knowledge related to the subjective perception of room modes. Therefore, a more informed

study on the effective control of room modes could benefit from further investigation on its subjective perception. Control methods may thus be guided into areas where greater subjective rewards are achieved resulting in more efficient treatments at a lower cost. The study of subjective perception of room modes presented in this thesis is thus justified.

5 Control of Room Modes

5.1 Introduction

Chapter 2 has covered previous research on methods to control the undesired effects of room modes. Examples range from the use of passive absorption (Voetman and Klinkby 1993; Herzog et al. 1995), and control of source positioning (Benjamin and Gannon 2000; Welti and Devantier 2003) to more sophisticated methods based on active absorption (Farnsworth et al. 1985; Darlington and Avis 1996; Makivirta, Antsallo, Karjalainen and Valimaki 2003) to improve control efficiency.

Chapter 4 has described a qualitative study about the views and preferences of users of professional control rooms. Even though most of the subjects interviewed worked at high-standard professional rooms, low frequency reproduction still emerged as the most common problem reported. Hence, it can be inferred that conditions providing ‘correct’ low frequency reproduction are still difficult to achieve and therefore require further understanding of the underlying issues.

Although the main subject of this thesis is to understand factors affecting subjective perception of resonances in rooms, an appreciation of practical issues regarding the implementation of control techniques is valuable and provides insight into the mechanisms underlying room resonances.

This chapter presents a practical study into the control of room modes. Two control methods are investigated. The first method, presented in section 5.2, is based on passive absorption. This method makes use of resonant membranes to achieve low frequency absorption but without requiring the large amounts of porous absorber usually necessary to control the long wavelengths at low frequencies. The second method, presented in section 5.3, originates in the vibration of plates as found in membrane absorbers. However, this method proposes an ‘active’ technique to generate the low frequencies and provide a controlled modal sound field through the use of distributed mode loudspeakers. The results of both methods are presented in light of the effects obtained in the frequency and temporal responses of the room.

One of the common techniques available for low frequency control takes the form of passive resonant membrane absorbers (Fuchs et al. 2000; Cox et al. 2004). This is a method that may be applied to rooms which have already been constructed but still exhibit low frequency problems, as identified in Chapter 4. The advantages of this type of absorber are that in theory it can achieve low frequency absorption from a relatively shallow device, therefore reducing the usage of space in the room for absorption. The technique itself is not novel and its mechanisms of

absorption have been thoroughly investigated (Fuchs et al. 2000; Cox et al. 2004). However, most of the published work fails to identify important issues related to the efficacy of these absorbers in practical applications.

Furthermore, in practical guidance for studio design, it is common to see advice on how to treat the problem of room modes (e.g. Everest 1997), suggesting that a few units of bass absorbers (usually resonant membrane type) placed in the corners of the room, will be sufficient to remove the problems of room modes. One of the objectives of this chapter is to demonstrate that in practice, and even with a considerable number of appropriately positioned absorbers, the problems may be diminished but still remain.

Section 5.2 of the current chapter presents two case studies as an investigation into the merits of resonant membrane absorption as a means to control the problems of room modes. Empirical data is used to infer on the efficacy of such methods and identify problems in practical implementations. The case studies provide information on the degree of control achieved with such techniques and focuses on the design, installation and absorption area of such absorbers. This highlights the problems of achieving appropriate control using passive absorption techniques to ‘treat’ the problematic room conditions mentioned in Chapter 4.

The case studies were carried out in two different rooms. Case study 1, presented in section 5.2.1, investigates the low frequency amelioration of a control room for a recording studio. Case study 2 is presented in section 5.2.2, and concentrates on the low frequency control of a listening room complying with recommended standards for the design and performance of critical listening rooms (IEC 268-13 1985; ITU-R BS 1116-1 1994; EBU Tech 3276 1998). The target control levels for each room originate from these published recommendations. It is shown that these resonant absorption methods require large amounts of absorption area, which may lead to increased difficulties in controlling other frequency regions due to the excessive use of wall area.

Moreover, previous investigations have shown that a similar absorption mechanism is found in rooms built with light partition walls (e.g. Maluski and Gibbs 2004). This absorption originates from the movement of the walls due to low frequency vibration. It is well known that light partitions allow sound to ‘escape’ the room, mainly through wall vibration and especially at the lower frequencies. Whilst this may pose a problem in terms of sound isolation, it is actually an advantage in the control of room modes, because the wall vibration damps their energy. The measurement of this type of absorption has been investigated (Bradley 1997) and practical applications are found in high quality professional control rooms (Newell 1995; Newell and Holland 1997). The large areas associated with this type of ‘absorption’, effectively the whole wall area, impart a good degree of control of the modal sound field, given that due to larger damping at the boundaries, the resonant decays have faster rates. This is the ultimate objective

of the aforementioned membrane absorbers, and indeed any passive low frequency absorption method. This decrease in decay rate corresponds to a reduction in the Q-factor of offending resonances.

The use of light wall partitions as a means of ‘control’ has to be taken into consideration at the design stage of the room as it can only be feasibly implemented during construction. Its use as a ‘treatment technique’ for completed control rooms would certainly be unacceptable due to the large disruption involved.

Nevertheless, the suggestion of large vibrating plates (much larger than the membranes on the passive absorption units under study here) at the room boundaries, may be explored in a different and novel approach to control the modal excitation in the room. The displacement of a plate, positioned at one of the room walls, may be controlled by the use of an exciter. In such a case, the plate may be considered as a sound radiator. Indeed, such behaviour is already exploited commercially in the form of *distributed mode loudspeakers* (DML) (Azima et al 1997, 1998; Angus 2000 a,b). The control of modal excitation using the radiation from a large plate is thus suggested.

This concept introduces a different approach in the control of room modes, presented in section 5.3, where the polar radiation pattern of a source (Ferekidis and Kempe 1996) and its location in relation to the mode-shapes in the room (Groh 1974; Benjamin and Gannon 2000; Welti and Devantier 2003) are exploited to achieve more controlled sound-fields. A generalised technique for looking at distributed-mode-source-room interaction using analytical and numerical solutions is explained. The computer model derived in Chapter 3 is improved to enable the analytical evaluation of the response of a simply supported plate radiator in a lightly damped rectangular enclosure. This provides the basis for investigating plate aspect ratios, damping and positioning. A numerical simplification is introduced which can be used to generate equivalent results, but which does not require the analytical evaluation of the integral of the product of source and room eigenvectors. This numerical method is then used to investigate the behaviour of sources with more complex boundary conditions, in particular plates with clamped boundaries and plates with free boundaries. The findings may be applied to the use of the *Distributed Mode Loudspeakers* (DML) for the reproduction of low frequencies in rooms.

The results from the two studies presented in this chapter indicate essential relationships between frequency and temporal responses of rooms according to changes produced by the control methods.

5.2 Resonant membrane absorbers

Efficient low frequency absorption is difficult to achieve using porous materials due to constraints with the size of the wavelength to be controlled. Consequently, means of efficient absorption at low frequencies have been developed to reduce the depth of absorbent material and increase absorption efficacy. One common solution is to use resonant membranes that vibrate in sympathy with an impinging sound wave. Examples of this type of absorption have been developed by Fuchs et al. (2000) among others. The behaviour and design of such devices is well known and there is no intention of covering that matter here. However, important features regarding design and installation are important in order to understand the results presented in the case studies, and will therefore be reviewed here.

A simple schematic of a membrane resonant absorber is shown in Figure 5.1.

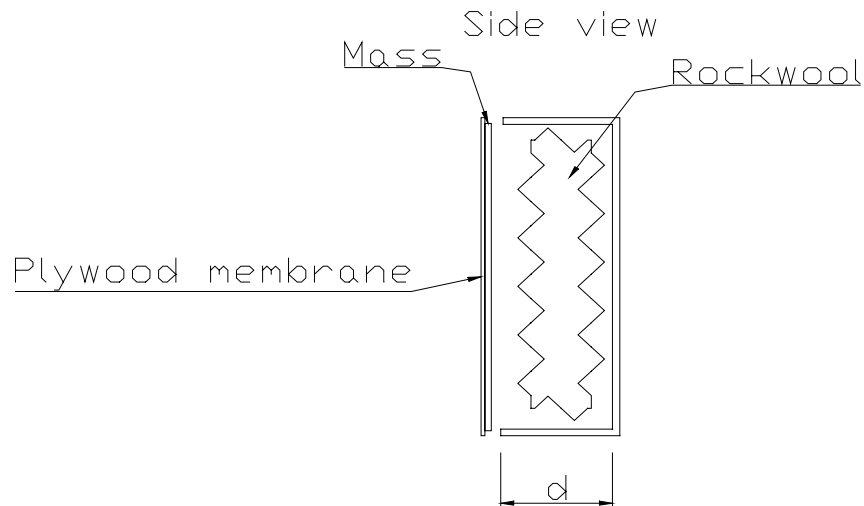

Figure 5.1 – Cut view of a membrane resonant absorber with thin plywood membrane.

Resonant membrane absorbers work on the principle that a thin membrane with a certain mass is attached to the front of an enclosed volume of air (see Figure 5.1). This effectively forms a one-degree-of-freedom mass-spring system with specific resonant frequency dependent on the volume of air in the cavity and the properties of the membrane. The design frequency may be determined from a simplified expression (Howard et al 1998):

$$f_0 = \frac{60}{(Md)^{1/2}} \text{ Hz}$$

Equation 5.1

where M represents the membrane mass in Kg/m^2 and d is the distance in metres between the membrane and the back of the cavity. This equation represents only an approximate value for

the frequency of resonance as it assumes that the membrane has no stiffness. Further corrections are usually included to take into account the bending stiffness of the membrane material and its proportions. More accurate prediction equations may be derived (Cox et al 2004), which take into account the membrane material properties, the effect of the porous material in the cavity and allow the prediction of absorption coefficients. The practical design and application in this chapter tries to follow current industrial practice and as such uses the approximate Equation 5.1.

The principle of absorption for such a system relies on the vibrations of the plate caused by the incident sound wave, which makes it sensitive to pressure and therefore more efficient when placed near the room boundaries (Groh 1974; Howard et al.1998; Angus 1999). Acoustic energy is thus transformed into heat through frictional losses in the membrane material and by the viscous losses in the material inside the cavity. If the impinging wave has the same frequency as the resonant frequency of the system, there is maximum displacement of the membrane, providing highest absorption. Higher vibrational modes provide reduced absorption due to their smaller displacements and poorer coupling when driven by normally-incident plane waves due to anti-phase displacement areas in the plate. This behaviour is actually exploited in section 5.3 but to achieve a different coupling pattern to the low frequency sound field rather than to absorb it.

In small plates the absorption at higher modes of vibration is in practice very small. Hence, the absorption characteristics of such a device may be described by maximum absorption at the resonant frequency with an operational bandwidth that is dictated by the damping of the system. The damping is controlled by the elastic properties of the membrane and further control is achieved by introducing viscous material in the cavity. Higher damping increases the bandwidth but reduces the absorption efficiency at the design frequency. Lightly damped absorbers may achieve high efficiency at the resonant frequency but their limited bandwidth and under-damped decays may render them problematic in practical applications. As will be seen in section 5.3.2, under-damping of radiating plates is also a problem when these are used as low-frequency sources.

As mentioned previously, to achieve high efficiency, such an absorber should be placed near the room boundaries, where sound pressure is high, and more specifically at positions where the pressure associated with the mode-shape to be controlled is high. Given this, it is clear that the efficacy of such a device will be reduced when it is designed to affect a group of mode-shapes with maxima at different regions in the room. Furthermore, as will be shown in sections 5.2.1 and 5.2.2, one single small device is not sufficient to effectively absorb a single resonance. It is shown that a large number of such devices are necessary to achieve even a small amount of control. Hence, in practical room applications, the positioning of many such devices at relevant high pressure zones becomes increasingly difficult.

When deciding on ‘treatment’ materials for design applications, designers usually rely on absorption information provided by manufacturers. This is usually given as an absorption coefficient over a range of frequencies, measured under specific conditions in reverberant chambers or using impedance tube techniques. For large areas of material, common absorption measurement techniques rely on the assumption that the sound field in the measuring facility is uniform. This is a premise that derives from the classical definition of reverberation time by Sabine. Depending on the size of the room, this situation is not always true at the lower frequencies. Indeed, the very same problem under study in this thesis also creates great difficulties in low frequency absorption measurements. This further reinforces the significance of position relative to the mode-shapes and how it may affect the absorption efficacy (Fuchs et al. 2000). As a result, characterization of the absorption coefficient for a low frequency absorber is problematic even before it is used in practice. This makes effective prediction of performance and subsequent installation a hazardous task.

5.2.1 Case study 1 – Low frequency absorption in a studio control room

A practical project was carried out to treat the response of a room at low frequencies. This was done in order to demonstrate the implementation difficulties in controlling modal sound-fields using a ‘remedial’ technique based on resonant absorption units. The effects on frequency and decay response of the room are discussed.

The room aspect ratios were decided according to an optimisation technique for optimal modal distribution (Cox and D’Antonio 1997), which attempts to avoid modal degeneracy. The inner shell dimensions of the room are 3.98 by 4.95 by 2.7 metres (length, width, height). Even though an optimal modal distribution avoids degenerate modes and their associated problems, it will be demonstrated here that the reverberation time at low frequencies will still be dominated by the decay rates of the existing room modes. Furthermore, the room under test was constructed in double partition brick wall in order to achieve the necessary sound insulation. Due to this sturdy wall construction, the low frequency absorption in the room is very low, leading to long resonant decays.

Following technical recommendations for critical listening rooms (IEC 268-13 1985; ITU-R BS 1116-1 1994; EBU Tech 3276 1998), it was found that the low frequency decay time in the room, below 200 Hz, was too long and thus needed to be controlled. This was identified after appropriate measurements. Two types of measurement, briefly described in Appendix II were carried out and the results are shown in figures 5.2 and 5.3.

Two sets of modules based on the resonant membrane absorber principle, as described in Figure 5.1, were designed with resonant frequencies of 45 Hz and 89 Hz respectively. These modules

were built using common construction materials, such as medium density fibreboard, a 4 mm thick plywood membrane and bitumen based roof felt, which was used to increase the damping of the membrane. The cavity was filled with fibrous material. The placement of the modules was arranged along each lower vertex of the room where the modal coupling is highest. Thirteen modules for each frequency were installed. This corresponds to an absorption area of nearly 4 m² at each ‘treatment’ frequency.

Figure 5.2 shows the magnitude frequency response of the room. This was obtained using a dual FFT analyser, and measured as described in Appendix II.i. The response *before* and *after* the low frequency control modules have been installed is shown up to 200 Hz. Black dots represent the calculated eigenfrequencies of the room.

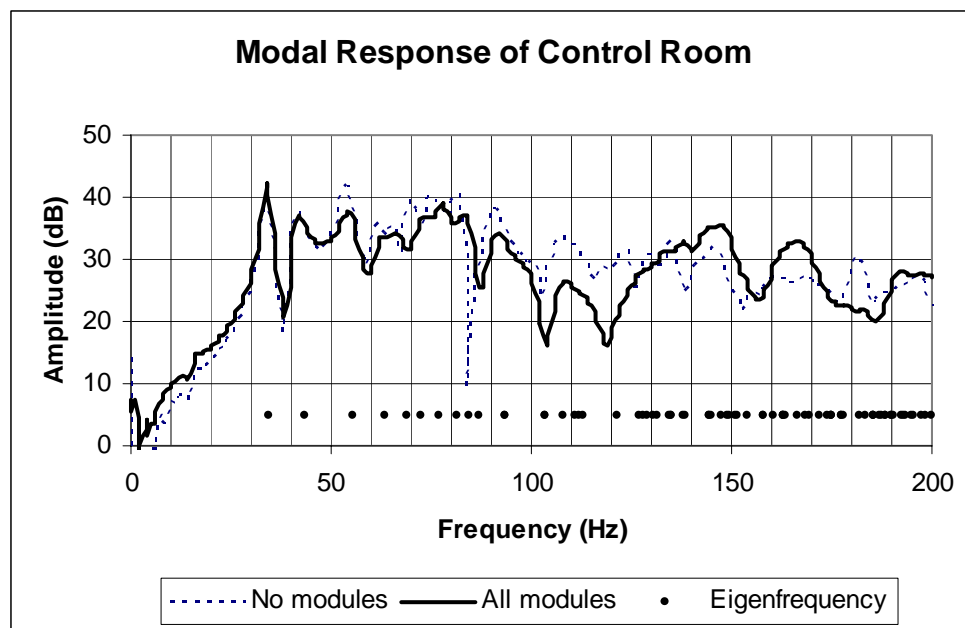

Figure 5.2 – Modal Response of Control Room. Measured room responses are shown before (---) and after (—) low frequency treatment with resonant membrane modules. Room eigenfrequencies are indicated in dots.

The dashed line, representing the room response before the low frequency control has been installed, clearly shows the large amplitude variations caused by the presence of resonances.

The installation of the absorption modules introduces changes in the modal response, as indicated in Figure 5.2. Changes are shown to occur mainly above 50 Hz. The reduction of the original room modes at 56 Hz and 92 Hz are particularly noticeable. This is not surprising given that at their resonant frequencies (45 Hz and 89 Hz), the two sets of absorbers installed have maximum performance. The remaining frequency range is also altered by the presence of the absorbers, although the potential benefits on the overall room response are difficult to interpret given that the large variations of pressure magnitude still remain after absorption.

The amplitude is shown to increase at some frequencies. This may be explained by the fact that the introduction of the absorbers changes the source radiation impedance at some frequencies, facilitating more effective energy transfer into the room. The low resolution of the plot does not enable a clear view of the expected widening of bandwidth at each resonance, which is known to correspond to a reduction of their decay rate.

The effects of absorption noticeable on the magnitude frequency response are difficult to interpret, since the amplitude variations have not been removed to a great extent. These effects are also expected to cause a decrease in the reverberation time in the room. This was measured in a number of positions in the room using appropriate measuring techniques based on MLS sequences with the due care necessary to measure reverberation time at such low frequencies (Appendix II). The average results are shown in Figure 5.3, before and after the introduction of the low frequency control modules.

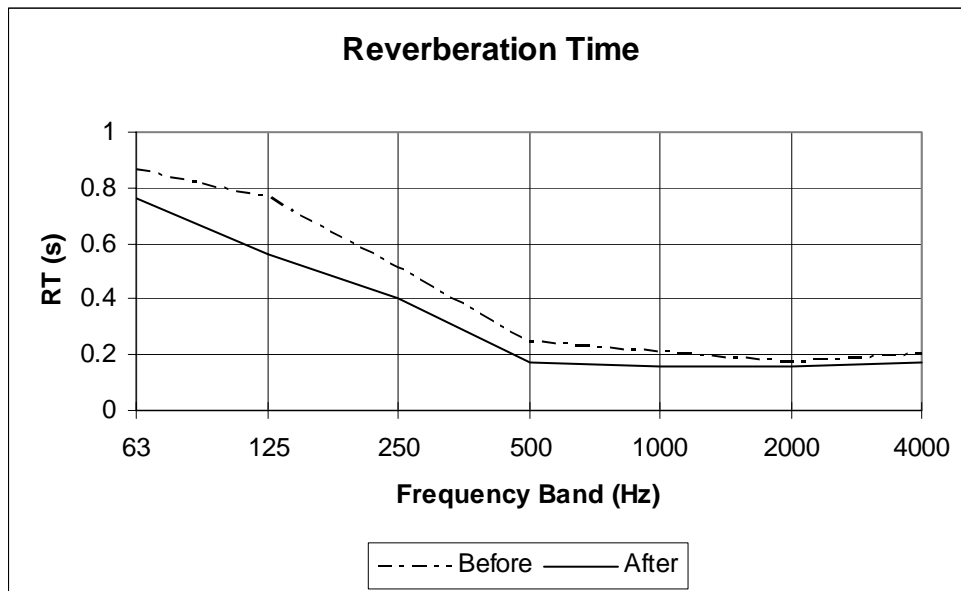

Figure 5.3 – Reverberation time measured in the control room before and after the introduction of low frequency control modules.

The resulting reverberation time differences show a more evident control of the resonant decays at the 63 Hz and 125 Hz octave bands. It is important to note that these results correspond to octave band average decay values and not to the decay of individual modes. The changes introduced are indicated in Table 5.1. The frequency range above 500 Hz has remained largely unaffected with only a slight decrease in the reverberation time, caused by the residual effects of the absorbers.

This example demonstrates that the use of membrane absorbers does have an objective effect on the modal sound field. The decay rates at the lower frequencies have been affected and this is shown by a decrease in the measured reverberation after the absorbers have been installed. The changes in the magnitude frequency response measured at a defined position in the room also

reveal the effects of the absorption, although the potential benefits are difficult to interpret given the remaining large variation of pressure with frequency.

Although a large number of absorption modules were constructed and installed, the final value of measured reverberation time at the two lower octave bands still does not comply with the recommendations (IEC 268-13 1985; ITU-R BS 1116-1 1994; EBU Tech 3276 1998). If this method is to be applied in the treatment of noticeable problems such as those referred in Chapter 4, more modules need to be installed to increase the absorption area and further decrease the decay rates. Defining the necessary reductions is in itself a problem, given that no knowledge of the subjectively acceptable levels for reverberation time at low frequencies has been gathered, and the only guidance available originates from postulates in the published recommendations. The determination of the necessary absorption area remains difficult, and would benefit both from a clear indication of the absorption coefficient of the devices as well as a subjectively valid target level for the noticeability of room modes. The latter topic has been addressed in Chapter 9.

The next section presents the implementation of the same type of absorption device but using commercially available units for which an absorption coefficient measured using standard methods is provided *a priori*. The practical implementation is thus guided by better information on the absorption characteristics of the devices.

5.2.2 Case study 2 – Correction of a listening room

A different room case was studied where the reverberation time should be corrected in order to comply with the aforementioned standards. The dimensions of the room are 6.88 x 4.63 x 2.81 metres (length, width, height) and comply with the IEC 268-13 (1985) recommendations.

The correction method took the form of commercially available resonant membrane absorbers with a lower bending stiffness membrane than that used in the previous example. This was evaluated intuitively, based on the materials of each membrane – 4 mm plywood in the previous case study and thin vinyl membrane in this case study. This was believed to provide better coupling to the room modes, due to the lower stiffness, and therefore increase absorption performance. Two sets of units with a different design frequency were used. These were 63 Hz (the lowest available) and 80 Hz (for corner mounting). Information and specifications on these products may be found at the manufacturer's website (RPG inc). Ten corner units were installed along the vertical corners of the room and a further twenty-eight units were installed along the side and front walls near the floor. This ensured that all absorbers were placed at high pressure zones thus increasing their coupling to the room modes and subsequent efficiency. The overall absorption area installed was about 14 m², corresponding to 4 m² at 80 Hz and 10 m² at 63 Hz.

Figure 5.4 shows the response measured at the optimum listening position before and after the low frequency control treatment.

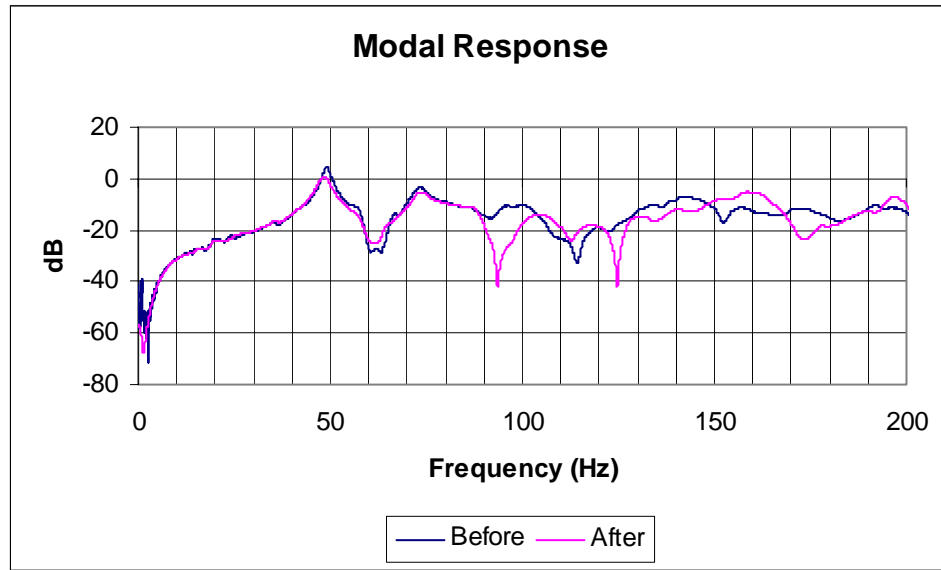

Figure 5.4 – Magnitude frequency response of a listening room before and after low frequency control.

Figure 5.4 shows some slight improvement on the magnitude frequency response in the 50 Hz to 90 Hz region. Indeed the level of some of the modes is altered, albeit by a small amount. It is interesting to note that the anti-resonances at around 60 Hz, near the resonant frequency of one set of units, has been altered to some extent. This shows evidence of absorption as the magnitude associated with these modes is reduced and therefore the anti-phase interaction between modes is not as pronounced. The effects at 80 Hz, corresponding to the design frequency of the other set of modules, is not as clear. Changes above 90 Hz are noticeable, in particular the increase in amplitude at some frequencies and the introduction of large dips in the response at 93 and 125 Hz.

The effects of this treatment were also evaluated by measuring the decay times at the octave bands of interest. Figure 5.5 shows the average reverberation time, measured at various positions in the listening area, before and after the units have been installed. This plot also shows the maximum and minimum values allowed by design recommendations (ITU BS1116-1 1994).

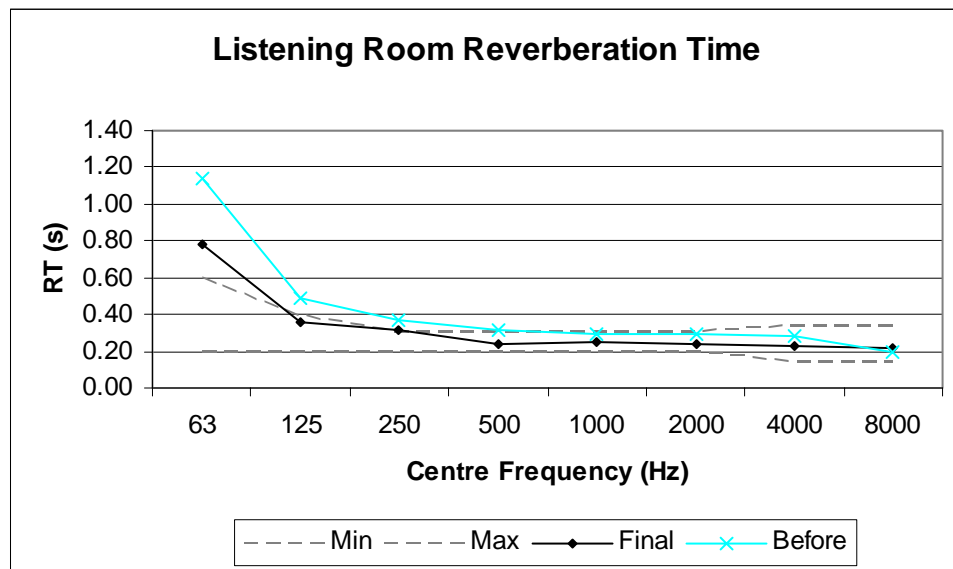

Figure 5.5 – Reverberation time for listening room measure before and after low frequency treatment.

Before and *after* reverberation time (RT) values and the corresponding changes obtained are indicated in Table 5.1. The final response in the room shows that desired control has been achieved down to 125 Hz, but the final RT value at 63 Hz is still above the accepted limits. Nevertheless, it is in this latter octave band that the treatment appears most effective, with a reduction of 0.36 seconds at 63 Hz. Again the larger resonant vibrating area provided by the units ‘tuned’ to 63 Hz has coupled to the room modes around this frequency more effectively and produced a large reduction in their decay rates. Hence, the effect of absorption is reflected in the average reverberation time measured in a large area of the room. The effects at the higher octave band are much smaller due to the smaller absorption area installed at this frequency.

These results demonstrate that the use of such commercial units has effectively achieved some degree of control around their design frequencies. The control at the lowest octave band is still deficient in achieving the desired target and this demonstrates the difficulty in attaining effective absorption at the lowest frequencies, where the energy in the modes is stronger and the decays become increasingly longer.

5.2.3 Performance of membrane absorbers

The results from the two case studies on the correction of low frequency sound fields in rooms show that a limited level of control is possible with the use of passive resonant absorbers. As demonstrated, this type of control technique is a possible solution for cases where the room is already in use but still suffers from low frequency problems. Several such cases have been revealed in the social survey presented in Chapter 4, where adequate control of the low frequencies is necessary using a solution that does not disrupt the, otherwise acceptable, acoustic design.

Although control is attainable, it is strongly dependent on factors such as absorption area and efficient coupling to the most problematic modes. Practical implementation requires large absorption areas, which may limit the number of frequencies effectively controlled.

The control provided by these absorbers has been shown to reduce the decay rates measured in a large area of the room and these are listed in Table 5.1. However, these effects are not as noticeable on an analysis of the magnitude frequency response plots.

A correspondence between decay time and frequency bandwidth may be obtained from *Equation 5.2* (Howard et al. 1998). The results obtained using this equation have to be considered carefully at low frequencies, given that diffuse field assumptions no longer apply and the decay time will be dominated by each room mode at its own eigenfrequency. Average data for reverberation time may be different from the individual decay of a room mode and should only be considered as a general indication of changes obtained in the low frequency sound field. A more accurate expression has been suggested by Angus (1999), where the decay of a single room mode is considered dependent on the effective absorption present at the boundaries associated with that specific mode and the distance between them. However, given that no information is available on the decay measured at specific frequencies, the general equation is appropriate.

Equation 5.2 further shows that a reduction in decay time corresponds to an increase in the bandwidth of the resonances. This is an important fact that will be explored further, when a study of perceptible changes in Q-factor of room modes is investigated in Chapter 8. The changes in decay time and Q-factor obtained for each case study in this chapter are indicated in Table 5.1. As referred above, these results are only an indication of the general changes in modal Q-factor due to the low frequency treatment employed. These figures may not be assumed to indicate the change to a specific mode, given its dependence on centre frequency.

$$T_{60} = \frac{2.2Q}{f_0}$$

Equation 5.2

Table 5.1 – Obtained values for CHANGES in RT and Q-Factor, according to measurements BEFORE and AFTER low frequency control. Alterations to the decay values have been converted to Q-factor values in order to evaluate the subjective perception of changes, according to new difference limen defined in Chapter 8.

			FREQUENCY(Hz)	
			63	125
CONTROL ROOM	BEFORE	RT(s)	0.90	0.80
		Q	25.77	45.45
	CHANGE	RT(s)	0.10	0.20
		Q	2.77	11.45
	AFTER	RT(s)	0.80	0.60
		Q	23.00	34.00
LISTENING ROOM	BEFORE	RT(s)	1.16	0.53
		Q	33.22	30.11
	CHANGE	RT(s)	0.36	0.13
		Q	10.22	7.11
	AFTER	RT(s)	0.80	0.40
		Q	23.00	23.00

The degree of control measured in the two cases is twofold. In the case of the control room, larger reductions were observed in the higher frequency band. In this case, it is important to note that the same amount of absorption area was installed for each ‘treatment’ frequency (4 m² at each 45 Hz and 89 Hz frequency). The larger reduction at the higher frequency band may be explained by the effect of the viscous material inside each absorption module, which is more effective as the wavelength decreases.

For the listening room case, larger reductions were observed at the lower octave band. This is explained by the larger absorption area installed near this frequency (10 m² at 63 Hz). It is difficult to infer on the effects of membrane stiffness in each device given that each set of results corresponds to a different room.

Once again, it is interesting to note that although the effects of the absorbers do not appear to alter the magnitude frequency response to a great extent (e.g. Figure 5.4) the changes measured in the low frequency decay time clearly reveal them (Table 5.1). This raises important questions on the relationship between common room quality descriptors such as magnitude frequency and decay responses (e.g. RT).

The data in Table 5.1 shows that resonant membrane absorbers effectively reduce the decay time of the resonances. Indeed, this confirms earlier published results showing that passive absorption methods for rooms have the effect of introducing larger damping and therefore

reducing the Q-factor of room modes (Herzog et al. 1995; Maluski and Gibbs 2004). It follows thus, that a known relationship between the changes obtained in Q-factor and its subjective perception may provide a means of testing the subjective efficacy of a certain treatment as well as defining targets for control methods leading to a more informed and efficient use of practical absorption techniques.

The subjective performance of the modular membrane absorbers used in the above case studies may thus be analysed using the results derived in Chapter 8, for the difference limen of Q-factors, and reproduced here in Table 5.2.

Table 5.2 – Difference limen for the Q-factor of room modes for each Q-factor target value.

Q-FACTOR TARGET	DL
1	16
10	10
30	6

If the changes obtained in the Q-factors for each case study, listed in Table 5.1, are compared to the difference limen, determined in Chapter 8 and replicated in Table 5.2, it can be seen that the low frequency treatment was effective in producing a perceptible difference (indicated in red in Table 5.1). The only case, where the perception of a change is not noticeable, is that imparted to the 63 Hz octave band in the *control room*. It is also, interesting to note that the final Q-factor values obtained in all cases are still high (23 and 34), indicating that perceptible decays still remain at these frequencies, because they are considerably higher than the minimum noticeable Q-factor of 16.

This analysis shows that the ‘treatment’ using membrane absorbers was effective in providing a noticeable difference in the room, but not effective in completely removing the perception of resonances at low frequencies. In an indirect way, this is in agreement with the published recommendations originally followed during treatment prescription (IEC 268-13 1985).

The empirical evidence shown in this section reveals that the performance of membrane absorbers in practical applications is very much dependent on their design frequency and the absorption area covered. It is shown that considerably large areas of wall surface need to be covered with such devices in order to achieve practical control. The efficiency of membrane absorbers is also limited by their operational bandwidth. If many ‘problematic’ frequencies need to be controlled, the need for large absorption areas at each frequency poses a great difficulty for controlling other frequency ranges due to the large wall areas needed.

In addition, and because the efficiency of these devices is shown to be dependent on their placement according to the room mode-shapes, successful implementation has to admit a

compromise between the number of different frequencies to be treated, the operational bandwidth of the absorbers (and consequently its absorption coefficient), and the effective area covered for each frequency. Optimising the placement of so many devices becomes difficult, leading to a random distribution of the devices along ‘known’ areas of maximum pressure. In conclusion, the treatment of problems such as those identified in the study reported in Chapter 4 appears problematic, as large areas of the existing room surfaces would need to be covered in membrane absorber modules, therefore altering the existing acoustic design.

It has been suggested in literature that rooms constructed in light partition walls have reduced pressure variation and shorter decay times at low frequency (Newell and Holland 1997; Maluski and Gibbs 2004). In reality, the problem is readily resolved due to the higher damping, and thus lower Q-factor, imparted on the resonances by the larger displacement of the walls. The inner shell of such rooms is in effect composed by very large ‘membranic’ structures, which most often have an air gap behind. These walls may thus be regarded as large plates that exhibit resonant behaviour. Furthermore, and due to their large size, these ‘membranes’ exhibit higher modes of vibration and therefore a wider absorption bandwidth. This is known to introduce low frequency absorption mainly because the energy is either allowed to escape the room or transferred into wall vibration. It appears thus, that modal control may be improved if the boundaries of the room are ‘allowed’ to vibrate in sympathy with the room modes.

Following these facts, a different approach is proposed in section 5.3 that uses a large single resonant plate that may be installed, and ‘actively driven at one of the walls in the room to generate the low frequency sound. Such a system could be suggested as a low frequency control solution in situations where modal problems still exist. The rationale for this system is based on the radiation pattern of vibrating plates and their coupling with the room mode-shapes. As will be demonstrated in the following sections, the possible benefits such a system would bring in practice are overridden by the large problems introduced. Nevertheless, interesting questions arise from the interaction of such a system with the room mode-shapes and this forms an important part of the thesis as it leads to further queries on the appropriateness of existing modal control techniques.

5.3 Rationale for the use of DML to excite low frequencies

This section presents a novel study on the excitation of modal sound fields utilising distributed mode sources, which follows from ideas on passive absorption by vibrating plates previously discussed in section 5.2.3. The objective is to investigate the interaction of actively driven plates with the mode-shapes in the room focusing on the improvement of low frequency excitation. The results of this investigation provide further motivation for the development of studies into

subjective perception of modal sound fields and the effects of control techniques, presented in Chapters 6, 7 and 8.

The radiation from vibrating plates has gained extended interest with the advent of the *distributed mode loudspeaker* (DML), a light plate with a transducer attached, which works by exploiting modal resonant behaviour (Azima et al. 1997, 1998, 1999; Angus 1999 a, 2000 a,b).

Classical plate theory (Warburton, 1954) shows that at their lowest resonant frequencies, the front radiation from DMLs is equivalent to monopole (1st mode) or dipole radiation ((2,1) modes). Additionally, work done by Ferekidis and Kempe (1996) reports on the benefits of using dipole sources to control the excitation of room modes.

The radiation from finite plates is demonstrated by Fahy (1985) and further studies demonstrate the use of this theory in the analysis of radiation by distributed mode loudspeakers (Angus 2000, a,b). It is shown that due to interaction between anti-phase displacement areas, the radiation from these plates at higher modes of vibration is generated mainly from strips at the edges or from the corners of the plate, depending on the frequency of the excitation signal. In practice, this changes the effective radiating position and shape of the source according to the excitation frequency. A large radiation plate may therefore be described as an atypical radiator where the source position varies with frequency.

It has been widely reported and is well understood that the position of the source in relation to the mode-shapes in the room is a critical factor in the excitation of the room modes. Indeed, this fact has been used in an effort to obtain a more homogenous low frequency response (Groh 1974; Cox et al. 1997; Benjamin and Gannon 2000; Welti and Devantier 2003).

The combination of the above mentioned facts may be explored in an effort to improve the low frequency reproduction in small rooms. The hypothesis to be tested is that a large vibrating plate radiating sound at low frequencies will interact with the room modal distribution in a different way to that of a point or piston sources due to its variation of the radiating positions. The resultant modal sound field is therefore expected to be different. If a plate is defined to be of substantial dimension compared to the dimensions of the room (e.g.: an entire wall), then effectively the radiation of sound at different frequencies will originate from different areas on the surface of that wall and consequently couple to different room mode-shapes.

In order to verify the differences in excitation created by a point source and a vibrating plate, a brief experiment was carried out using a 1:5 scale model of a room. For the purpose of the experiment, the room may be considered lightly damped and rectangular in shape. The sources used were a 7 cm cone driver in a closed box and an 80 by 60 cm fibreboard DML plate mounted on a metal frame, with a single exciter attached. Measurements were taken using a dual FFT analyser. The input signal driving the speaker was compared to the signal picked up at

a microphone in the room. The results are presented as *transfer function* magnitudes. Phase information was also acquired. The measurement point was chosen to be one of the corners of the room where the modes have anti-nodal points. As a reference the modal behaviour of the room was measured by placing the piston source at the corner opposite the microphone.

The results obtained represent frequencies up to 100 Hz related to the scale of the model. This concentrates on the low end of the auditory frequency range where modal density is usually sparse and therefore a problem. Measurements were taken using various plate positions in the room. Results for both sources were normalised in level.

Figure 5.8 shows the resulting modal response for two different plate positions contrasted with point source excitation indicated in black. Some of the expected room modes are indicated by numbers that refer to the modal order in each of the (*x-length*, *y-width*, *z-height*) room coordinates. The blue line represents the response measured when the plate is placed flat in the middle of the room, with its longest dimension along the length of the room. This set-up is illustrated in Figure 5.6.

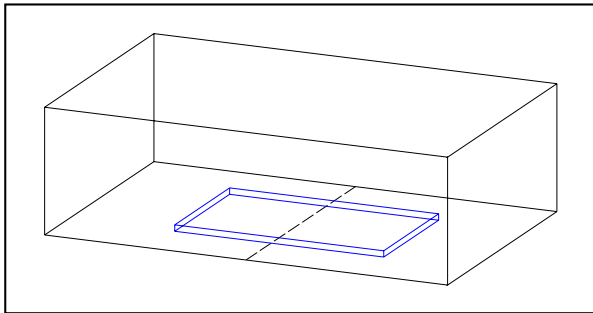

Figure 5.6 – DML in position 1.

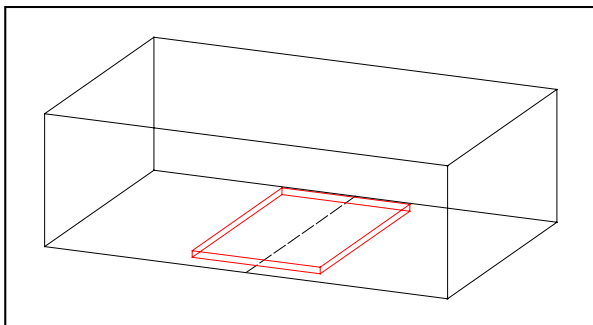

Figure 5.7 – DML in position 2

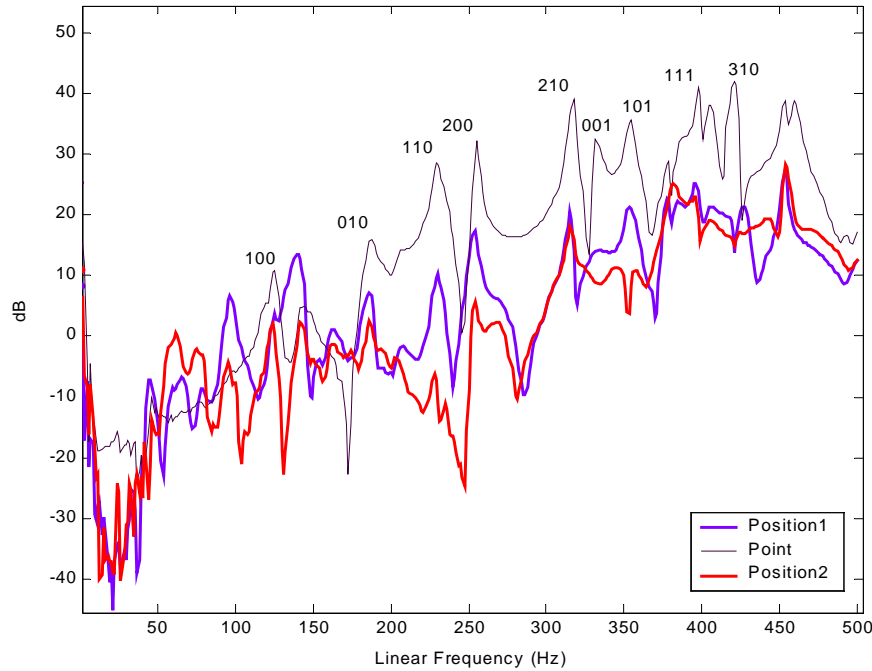

Figure 5.8 – Modal frequency response for point source and distributed mode loudspeaker in a 1:5 scale room. Numbers indicate the modal order in each of the room dimensions (x -length, y -width, z -height). Two DML positions are shown.

The differences between point and plate excitation sound fields are evident. However, due to its central position in the room, the differences obtained with the plate could be construed as emerging from the simple variation in mode-shape coupling. Indeed, because it is placed in the centre of the room, the coupling to odd order axial modes in the x and y dimensions of the room is expected to be weaker than that experienced by the point source in the corner. However, the plate has a finite size that is large comparable to higher order mode-shapes in the room. This is expected to induce different coupling patterns, as reflected in the differences of excitation measured at higher frequencies.

A further test was carried out, now placing the plate in the middle of the floor, with its longest dimension running perpendicular to the length of the room. The plate used was almost as long as the width of the room, consequently covering an area strip between the two side walls (see Figure 5.7). The resultant modal distribution is depicted in red in Figure 5.8.

As in the previous case, there is an evident difference in excitation level at the lower order room modes. However, the noticeable dissimilarities between the two plate positions obtained at higher frequencies once again demonstrate that large differences in coupling pattern emerge. This result confirms earlier suggestions that the distributed behaviour of DML may be convenient in providing different coupling patterns depending on its size and position according to the room mode-shapes.

Other plate positions were measured and the general trend is that although many of the room modes are still present, the amplitude peaks are drastically reduced or even removed. The overall response appears to indicate that the resonant frequencies of the plates are superimposed on the resonant behaviour of the room, especially at the lower end of the frequency range, where plate damping may be lower. Indeed, this behaviour is observed later in section 5.3.2, and its dependence on plate damping is confirmed.

These results give a clear indication that the excitation of room modes will depend on the type of source used. Furthermore, it is clear that the excitation of the sound field varies depending on source distribution and placement. This indicates that the positioning of the plate and its relationship to the mode-shapes in the room may be an important factor to study.

Unfortunately, no decay times were measured, therefore the possible benefits achieved on the modal decay cannot be evaluated.

The results obtained here have been based on a scale model and a plate over which there is no control on size, or material parameters. In order to explore the possible benefits of using such a system in real size rooms, the prediction model introduced in Chapter 3 needs to be further developed to accommodate for the use of distributed sources. This is developed in section 5.3.1. Ensuing that, a dedicated study on the interaction of radiating plates in rooms is carried out. This is detailed in section 5.3.2.

5.3.1 Prediction models for distributed sources in rooms

The next sections present derivations for analytical and numerical models to predict the behaviour of different types of plates as radiating sources in small rooms. The models presented here are intended to provide a further insight into the behaviour of large distributed sources in enclosed spaces. The effects of plate positioning and damping on the room modal response are investigated.

5.3.1.1 Classical plate theory review

The displacement on the surface of a rectangular vibrating plate can be described as (Warburton 1954):

$$w(x, z) = j\omega F \sum_n \frac{\psi_{rcv}^{(2)}(x, z) \psi_{src}(x_0, z_0)}{\Lambda_n [\omega_n^2 (1 + j\eta) - \omega^2]}$$

Equation 5.3

The source and receiver shape functions for the plate appear in the numerator of Equation 5.3. It is not surprising that Equation 5.3 is similar to Equation 3.22, for the modal response in a room. Both situations can be described as modal systems, with three dimensions in the room and two on the surface of plates. It follows, thus that the behaviour of resonant plates is very much similar to the resonant behaviour of an enclosed space. Parameters such as modal distribution, dependence on damping and aspect ratios are common to both systems.

Different types of boundary conditions for the plates result in different solutions and will therefore imply different receiver shape functions. The solutions for *simply supported*, *clamped* and *free* edges on a plate undertaking vibrational movement have been derived (Warburton 1954; Fahy 1985) and are indicated below. Variables a and b represent the dimensions of the plate in the x and z dimensions respectively.

For a simply supported plate defined on a (x,z) system of co-ordinates, the source and receiver shape functions are given by:

$$\psi_{ss} = \sin\left(\frac{n_x \pi}{a} x\right) \sin\left(\frac{n_z \pi}{b} z\right)$$

Equation 5.4

where n_x and n_z take integer values, and represent the mode numbers on the x and z dimensions on the plate. x_0 and z_0 are substituted to form the *source shape function* and indicate the exciter position on the plate surface.

The resonant frequency of the plate is given by

$$\omega_n = \sqrt{\frac{D}{M} \left[\left(\frac{n_x \pi}{a} \right)^2 + \left(\frac{n_z \pi}{b} \right)^2 \right]}$$

Equation 5.5

where M is the mass per unit area of the plate, and

$$D = \frac{Eh^3}{12(1-\nu^2)}$$

Equation 5.6

E is the elasticity modulus, h is the thickness and ν is the Poisson's ratio for the plate material.

For clamped and free edges the receiver eigenvectors assume a more complex form. Expressions are presented for one spatial dimension only. The complete shape function is thus obtained by the product of the given expression and the one resulting from substituting x with z . The n indexes correspond to the number of nodal lines in the plate for each mode. For example

a second mode on a clamped edge plate has three nodal lines – the two edges and the one through the centre line.

For edges clamped at $x = 0$ and $x = a$:

$$\psi_{Cl}(x) = \cos\left(\gamma_{n_x}\left(\frac{x}{a} - \frac{1}{2}\right)\right) + k_{n_x} \cosh\left(\gamma_{n_x}\left(\frac{x}{a} - \frac{1}{2}\right)\right)$$

Equation 5.7

where $k_{n_x} = \frac{\sin\left(\frac{\gamma_{n_x}}{2}\right)}{\sinh\left(\frac{\gamma_{n_x}}{2}\right)}$ and $\tan\left(\frac{\gamma_{n_x}}{2}\right) + \tanh\left(\frac{\gamma_{n_x}}{2}\right) = 0$

for $n_x = 2, 4, 6, \dots$ and

$$\psi_{Cl}(x) = \sin\left(\gamma_{n_x}\left(\frac{x}{a} - \frac{1}{2}\right)\right) + k_{n_x} \sinh\left(\gamma_{n_x}\left(\frac{x}{a} - \frac{1}{2}\right)\right)$$

Equation 5.8

where $k_{n_x} = -\frac{\sin\left(\frac{\gamma_{n_x}}{2}\right)}{\sinh\left(\frac{\gamma_{n_x}}{2}\right)}$ and $\tan\left(\frac{\gamma_{n_x}}{2}\right) - \tanh\left(\frac{\gamma_{n_x}}{2}\right) = 0$

for $n_x = 3, 5, 7, \dots$

For edges free at $x=0$ and $x=a$:

$$\psi_F = 1 \text{ for } n_x = 0$$

$$\psi_F = 1 - \frac{2x}{a} \text{ for } n_x = 1$$

$$\psi_F(x) = \cos\left(\gamma_{n_x}\left(\frac{x}{a} - \frac{1}{2}\right)\right) + k_{n_x} \cosh\left(\gamma_{n_x}\left(\frac{x}{a} - \frac{1}{2}\right)\right)$$

Equation 5.9

where $k_{n_x} = -\frac{\sin\left(\frac{\gamma_{n_x}}{2}\right)}{\sinh\left(\frac{\gamma_{n_x}}{2}\right)}$ and $\tan\left(\frac{\gamma_{n_x}}{2}\right) + \tanh\left(\frac{\gamma_{n_x}}{2}\right) = 0$

for $n_x = 2, 4, 6, \dots$ and

$$\psi_F(x) = \sin\left(\gamma_{n_x}\left(\frac{x}{a} - \frac{1}{2}\right)\right) + k_{n_x} \sinh\left(\gamma_{n_x}\left(\frac{x}{a} - \frac{1}{2}\right)\right)$$

Equation 5.10

$$\text{where } k_{n_x} = \frac{\sin\left(\frac{\gamma_{n_x}}{2}\right)}{\sinh\left(\frac{\gamma_{n_x}}{2}\right)} \text{ and } \tan\left(\frac{\gamma_{n_x}}{2}\right) - \tanh\left(\frac{\gamma_{n_x}}{2}\right) = 0$$

for $n_x = 3, 5, 7, \dots$

Approximate resonant frequencies for clamped and free edge plates are obtained from

$$\omega_n = \frac{2\lambda h \pi^2}{a^2} \left[\frac{E}{48\rho(1-\nu^2)} \right]^{1/2}$$

Equation 5.11

$$\text{where } \lambda = G_x^4 + G_z^4 \frac{a^4}{b^4} + 2 \frac{a^2}{b^2} [\nu H_x H_z + (1-\nu) J_x J_z]$$

Equation 5.12

Values for G, H and J may be found in Appendix III.ii.

5.3.1.2 Analytical model for simply supported plate in room

To be able to evaluate the behaviour of distributed sources in enclosed spaces, Equation 3.22, needs to be redefined to include a source shape function that represents the type of plate used.

The modal response of the room excited by a distributed source is obtained from solving the triple integral of the product of source and room eigenvectors. This task escalates in complexity for the cases of free and clamped edge plates.

In the case of a simply supported plate, defined in Equation 5.4, the following integral, representing the radiation of a simply supported source in a three dimensional enclosed space needs to be solved.

$$C_n = \frac{Q}{X_n} \int_{z_1}^{z_2} \int_{y_1}^{y_2} \int_0^{l_x} \delta(x - x_0) \sin(k_{p_y} y_p) \sin(k_{p_y} y_{p0}) \sin(k_{p_z} z_p) \sin(k_{p_z} z_{p0}) \cos(k_{r_x} x) \cos(k_{r_y} y) \cos(k_{r_z} z) \partial x \partial y \partial z$$

Equation 5.13

where the indexes p and r represent plate and room respectively, y_1, y_2 and z_1, z_2 are the limits of the plate in the room, in a similar manner to that used for the definition of the rectangular piston plate in Chapter 3. y_p, y_{p0} and z_p, z_{p0} may be defined in terms of y, y_1 and z, z_1 and define receiver and exciter positions on plate respectively. k_p and k_r represent the wave numbers for each dimension of plate and room respectively.

The result is an expression that allows the evaluation of the source-receiver transfer function at any given point in a room, using a simply supported plate. The following is a suggested expression for a simply supported source shape function to be used in Equation 5.3:

$$\Psi_{src} = \Psi_{SS} = \sum_n^{(2)} \left[\frac{\sin(k_{p_y} y_{p0}) \sin(k_{p_z} z_{p0}) \cos(k_{r_x} x_0)}{\omega^2 - \omega_{n_{plate}}^2 - 2i\delta_{n_{plate}} \omega_{n_{plate}}} \left(\frac{1}{(k_{p_y}^2 - k_{r_y}^2)(k_{p_z}^2 - k_{r_z}^2)} \right) \dots \right] \left[\cos(k_{p_y} y_1) A_y + \sin(k_{p_y} y_1) B_y \right] \left[\cos(k_{p_z} z_1) A_z + \sin(k_{p_z} z_1) B_z \right]$$

Equation 5.14

where

$$A_y = k_{p_y} \left[\cos(k_{p_y} y_2) \cos(k_{r_y} y_2) - \cos(k_{p_y} y_1) \cos(k_{r_y} y_1) \right] + \dots \\ \dots + k_{r_y} \left[\sin(k_{p_y} y_2) \sin(k_{r_y} y_2) - \sin(k_{p_y} y_1) \sin(k_{r_y} y_1) \right]$$

and

$$B_y = k_{p_y} \left[\sin(k_{p_y} y_2) \cos(k_{r_y} y_2) - \sin(k_{p_y} y_1) \cos(k_{r_y} y_1) \right] + \dots \\ \dots + k_{r_y} \left[\cos(k_{p_y} y_1) \sin(k_{r_y} y_1) - \cos(k_{p_y} y_2) \sin(k_{r_y} y_2) \right]$$

The derivation of the above expressions may be found at Appendix III.

The presence of hyperbolic functions in the mode-shapes of clamped- and free- edge plates renders the derivation of an analytical solution rather time consuming and prone to errors. Therefore a numerical model based on the superposition principle was developed. This is described in more detail in the next section.

5.3.1.3 Superposition model

Another method of simulating the response of a distributed type source in a room is to use a superposition technique, where the response of the room to a large plate may effectively be calculated from the individual contributions of a number of smaller radiating plates that exhibit piston movement. The original distributed mode plate is divided into smaller rectangular elements. The phase and amplitude displacement of each of these elements is calculated according to their relative position in the main plate structure. The resulting pressure at a location in the room is thus determined by:

$$p_{sup}(\vec{r}, \omega) = \sum_h^{\text{number of elements}} i\omega\rho_0 c^2 Q_h \sum_n^{(3)} \frac{\psi_{PP}(h)\psi_{REV}}{\omega^2 - \omega_n^2 - 2i\delta_n \omega_n}$$

Equation 5.15

In Equation 5.15, Q_h represents the complex displacement amplitude for each element, and takes the form of equations 5.4, 5.7 or 5.9 depending on the type of plate used. Each ψ factor

represents the source shape function for a piston plate and the receiver shape function for a rectangular room. These are given in equations 3.8, 3.25, 3.26 and 3.27.

Equation 5.15 is based on the model derived to calculate the response of the room when excited by a rectangular piston. The introduction of the first summation sign indicates that the total response is obtained from the sum of the contributions of each individual piston plate. The numerical method iterates through all the piston elements that constitute the distributed mode plate. The matrix of rectangular pistons that constitute the distributed mode source is defined using a concept borrowed from finite element model techniques. Hence, a minimum of 6 elements per shortest wavelength is used.

A comparison between analytical and superposition models for a simply supported plate is shown in Figure 5.9.

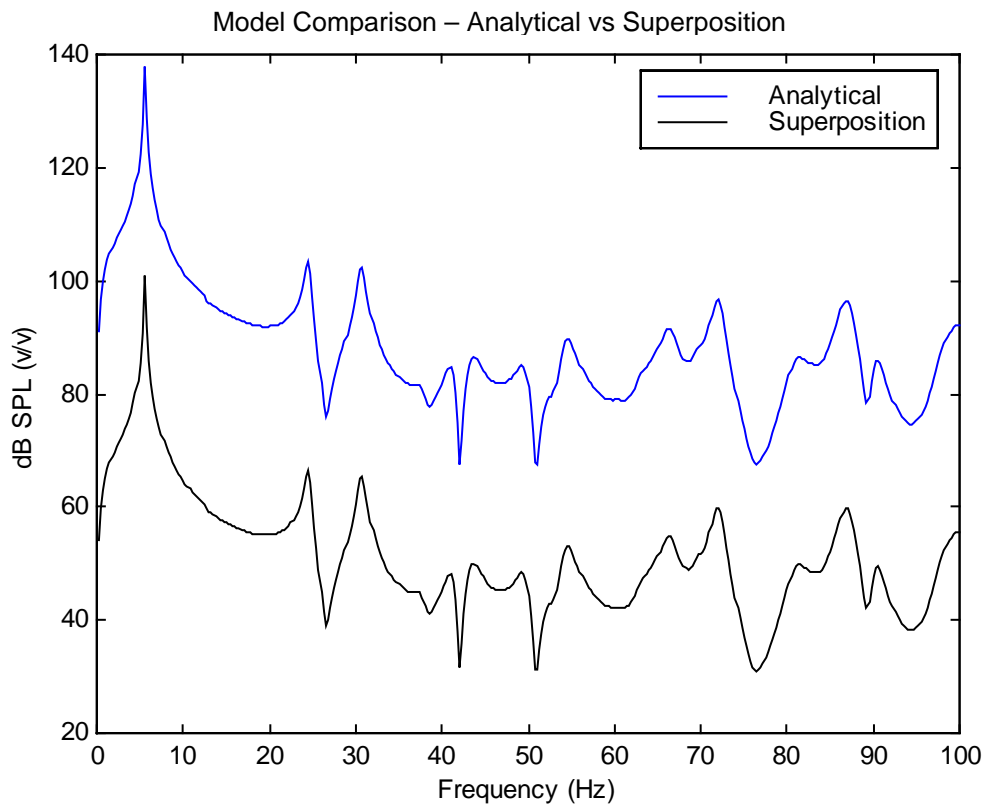

Figure 5.9 – Comparison between analytical and numerical based prediction models for a simply supported plate in a rectangular room.

The results for the two models are identical. The obvious difference in level originates from the differences in the source strength between the two cases. The modal response is not affected and therefore this has not been equalised. Although introducing a longer computational time, this superposition technique can be used to evaluate the response of clamped and free edge plates as sources in a room.

None of the models described above takes into account the air loading effects on the plate. If sufficiently large, these loading effects could change the resonant frequencies of the plate and their damped behaviour. Following similar assumptions for the simulation of conventional cone loudspeakers in rooms, the loading effects on the plates are not taken into account. The modal frequency shift imposed on the radiation of the plates would not affect the general trends observable and in order to reduce the complexity of the expressions, this factor was not accounted for in the model.

5.3.2 Applications to low frequency room excitation

The previous section shows the derivation of expressions that allow the use of large vibrating plates as sources in the prediction of enclosed sound-fields as introduced in Chapter 3. Using this, it is now possible to simulate the interaction between large radiating plates and the room. The potential benefits of using large distributed sources as a means for low frequency control is now investigated.

Using the superposition expressions derived for the interaction of distributed sources in a room, a simulation may be carried out to determine the transfer function for a given source-receiver combination. All simulations calculated assume the receiver point to be at a corner of the room, where room modes have anti nodes. The position of the plate is always at a room boundary, so that only front radiation into the room is assumed.

The first case to consider is that of a room which is very long, short and narrow. This is effectively a rectangular duct (along the x dimension), where length axial modes (the largest dimension) are at much lower frequencies than other modes. If the source is then placed normal to this dimension and next to one of the walls (at a pressure antinode), strong length axial modes are expected to be excited.

Figure 5.10 shows simulation results for each plate type. Excitation by a piston plate of the same size is also shown for comparison. In this case each plate is defined to be as large as the parallel wall just behind it. The centre point of the source is defined at the centre of the room wall where it is placed. The material parameters for each plate are the same. This was chosen arbitrarily so that the first mode for the simply supported plate appeared at 20 Hz.

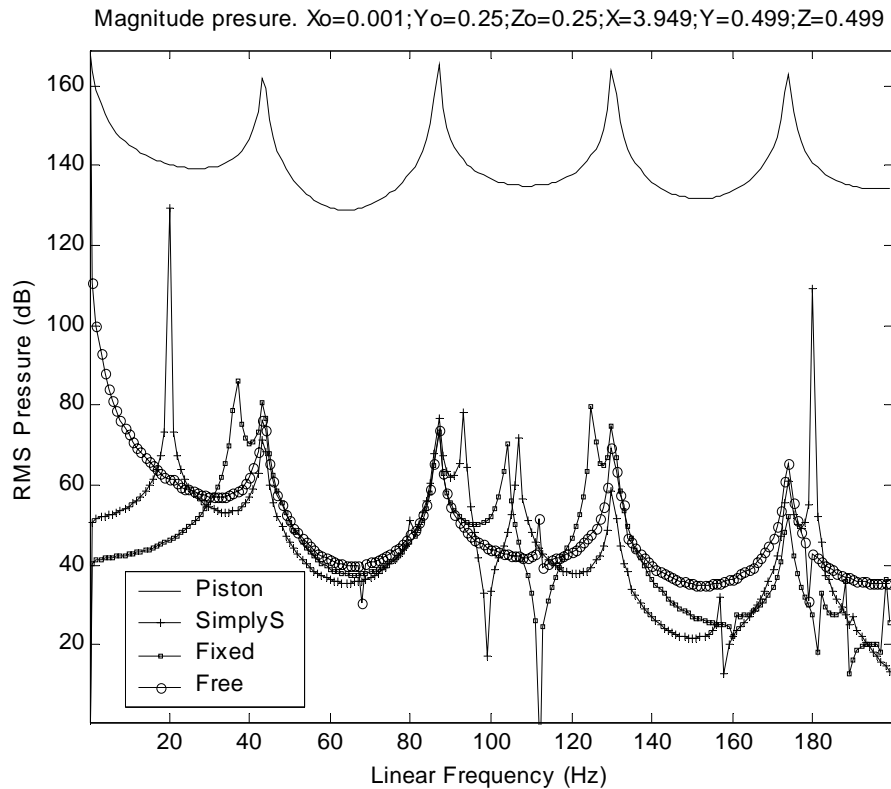

Figure 5.10 – Modal response of a rectangular duct using distributed mode plates. Results are compared to excitation from a large rectangular piston shown in the solid black line. All plates are positioned at one end of the duct.

It is clear that the pistonic plate excites the strong axial modes which occur at 44 Hz, 88 Hz and higher harmonics. All distributed mode sources superimpose their own resonant frequencies to produce a different response to that obtained with a piston. The introduction of plate resonances in the overall room response had already been observed in the scale model measurements presented in section 5.3.

Examination of these results indicates that the general effects obtained with distributed plates are common to all types of plate boundary conditions. Namely, the introduction of specific resonant frequencies from each type of plate. There appears to be no benefit in terms of controlling any of the room modes. For regions such as between 88 Hz and 130 Hz, the average number of resonances is drastically increased by the addition of plate resonances. If recommendations on modal distribution (Louden 1971; Bonello 1981; Walker 1992; Cox et al. 1997) are considered, this effect may suggest an improvement of the sound field. This requires verification by subjective testing, and is addressed in Chapter 6.

Although the excitation of modes normal to the plate is of interest, it is those mode-shapes that have large pressure variation in the plane of the plate which are most likely to be affected by the distributed behaviour of the source.

The simulation was changed such that the plate is now placed along the longest room dimension (see Figure 5.11), where the spatial pressure variation associated with the axial mode-shapes is larger along the length of the plate rather than perpendicular to it. Figure 5.12 shows the resulting magnitude pressure response.

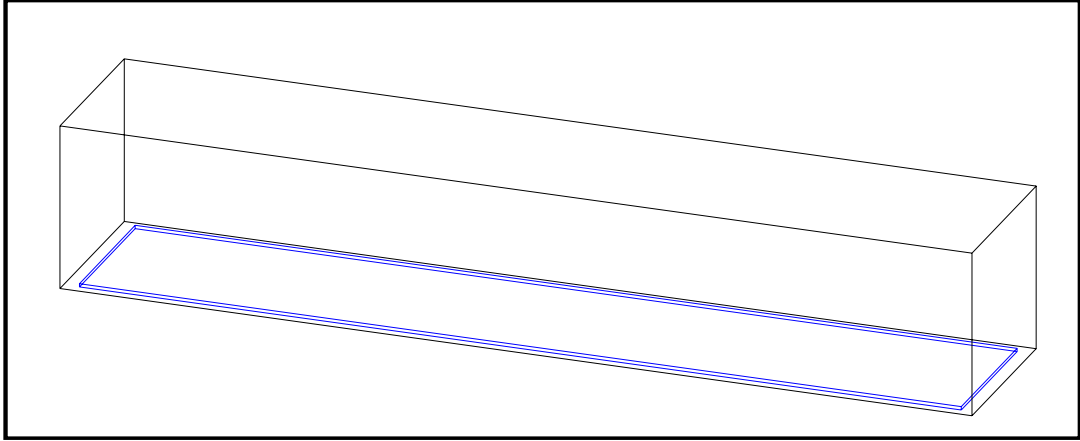

Figure 5.11 – Plate defined as one surface of the duct.

Expected axial room modes in this case form a series 72 Hz, 144 Hz, etc. The plate material parameters are arbitrarily determined so that the first resonance for a simply supported plate is at 20 Hz.

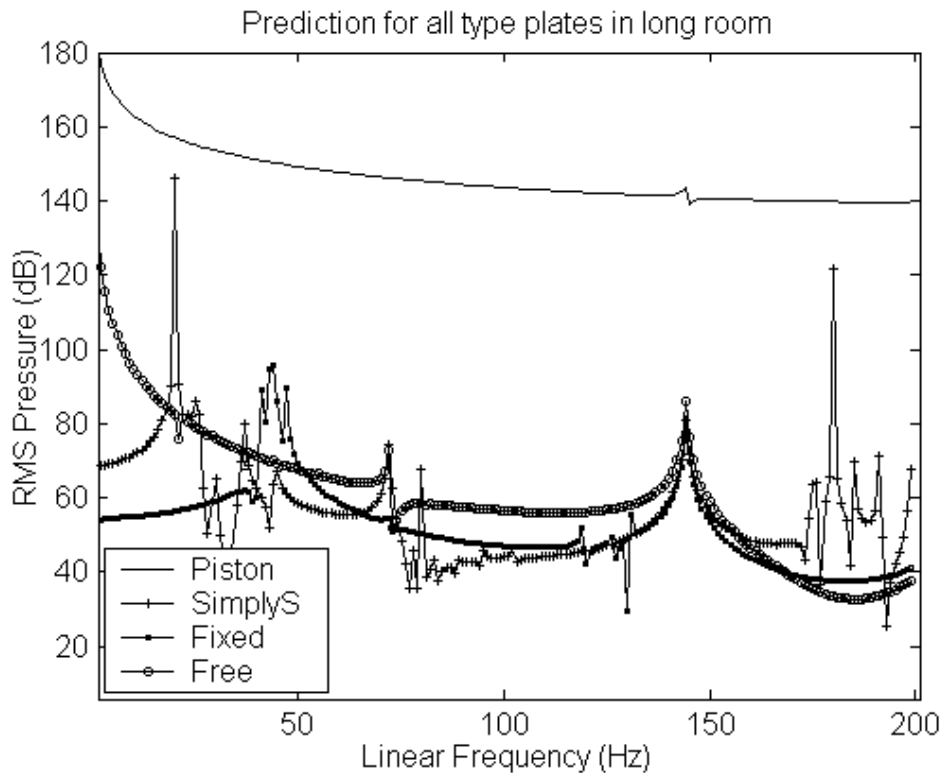

Figure 5.12 - Modal response of a rectangular duct using distributed mode plates. Results are compared to excitation from a large rectangular piston shown in the solid black line. All plates are positioned along the longest dimension of the duct

Observing the results in Figure 5.12, it is interesting to note that the piston plate does not excite the expected axial modes along the room, producing a smooth magnitude frequency response. Other simulations have shown that if the size of the piston plate is reduced, the room mode at 144 Hz becomes more noticeable whilst the room mode at 72 Hz is still not excited at all. In this case, the first resonant mode is excited only when the centre of the plate is moved from its nodal position, in the centre of the room. This effect is explained by the fact that the piston plate is simultaneously coupling into positive and negative phase regions of the first axial mode-shape. This gives a further insight into how distributed sources will couple with the room mode-shapes and affect the excitation of the low frequencies.

The response of the room to excitation using distributed mode plates does not show much improvement over responses expected using a point source which results in peaks in the magnitude response at 72 Hz and 144 Hz. Although the resonant frequencies from the plate responses are superimposed on the overall room response, generating areas with higher modal density, the original peaks associated with the room modes are still evident. This effect appears to be common to all types of plates allowing for the different modal distribution associated with each type of plate.

Apart from a characteristic modal distribution for each plate condition, there appears to be no benefits for using any particular plate type. Given this, it was decided to use the faster analytical model for a simply supported plate in order to carry out further studies.

Due to problems in modelling the behaviour of real plates using analytical solutions, an issue connected with definitions of plate material parameters (Avis and Copley 2000), the predictions employ arbitrary values which enable the characteristic distribution of resonances in the plate to be altered as suitable.

Preliminary tests have shown that if a plate could be artificially set to vibrate only at combinations of even modes, such as the (2,2), (4,2) or (10,2), then some of the room modes would not be excited at all. These combinations of modes in plates are peculiar as each positive phase radiating area is counterbalanced by an anti-phase one. As these displacement areas exist in even numbers, cancellation occurs. In spite of its apparent benefits, these situations are only possible under simulation, but indicate the potential benefits of excitation mechanisms from distributed sources.

The simulation results presented hitherto suggest that the mechanisms involved in driving room modes may be highly dependent on the source radiation patterns. This has been previously investigated by Ferekidis et al. (1996), who suggested the use of dipolar sources to control the excitation of specific room modes. Hence, a frequency match between specific plate displacement patterns, associated with its modal response, and the room mode-shapes is

expected to result in combinations where some degree of control may be achieved. In this case, the plate should be positioned so that its surface is parallel to the pressure variation concerning the room modes under control, as shown in Figure 5.11.

A different simulation case has been studied where a specific plate eigenfrequency matched the frequency of the first axial mode of a rectangular duct. This frequency match between plate and room modes was obtained by adjusting the plate's elasticity modulus (E in Equation 5.11) to achieve the desired plate modal response. The dimensions of the plate were defined to cover one wall over the entire length of the duct. Only the analytical model for a simply supported plate was used for this example. The magnitude frequency response is shown in Figure 5.13.

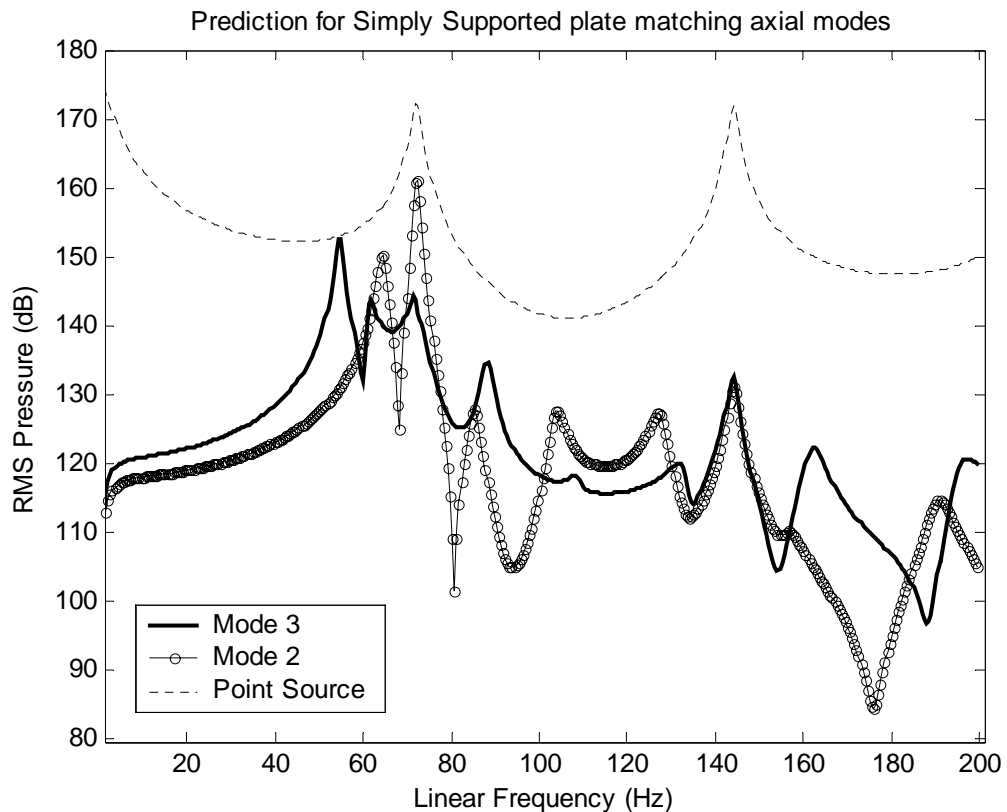

Figure 5.13 - Modal response of a rectangular duct excited by a simply supported plate. Results are compared to point source excitation shown in dashed line. Two plate situations are shown, with modal matching at second and third modes on the plate.

For this case, axial room modes are expected at 72 Hz and 144 Hz. Two cases have been studied. The first case matched the second eigenfrequency on the plate with the frequency of the first mode in the duct – labelled in Figure 5.13 as *mode 2*. In general terms for this case, the plate displacement pattern may be described as two main sections with anti-phase displacement, effectively forming a dipole. Comparing the results to those obtained for a point source, it is clear that the first room mode is still excited strongly. This strong excitation of the first room mode is expected given that the anti-phase displacement areas of the plate couple effectively with the mode-shape in the room.

The second room mode is excited at a lower magnitude. In this case, the nearest resonance on the plate corresponds to its sixth eigenfrequency, at 132 Hz, along its longest dimension. The smaller plate displacement at this frequency and the lack of a matching plate eigenfrequency results in a lower magnitude excitation.

A second case investigated the interaction of a plate defined so that its third eigenfrequency matched the first room mode – labelled *mode 3* in Figure 5.13. The effect is a clear reduction on the amplitude of the first room mode by a value of about 15dB.

This reduction in amplitude of excitation at this specific frequency may be explained as follows. The response is analytically defined from the integral of the product of room and plate eigenvectors. The plate displacement may effectively be divided into three equal size sections. The middle section moves in anti-phase with the two outer sections. Due to the anti-phase combination of two of these sections, only a smaller area of the plate is left to couple to the room mode, and therefore produce a lower amplitude excitation level. In practice, this observed reduction may be attributed to a decrease in the radiation area of the plate.

The magnitude of the second room mode is lower because there are no specific plate resonances matching this frequency. The nearest plate eigenfrequencies are 127 Hz (5th plate eigenfrequency) and 156 Hz (6th plate eigenfrequency).

It appears, from observation of Figure 5.13, that there is some modal control obtained when the 3rd eigenfrequency of the plate matches the frequency of the first axial room mode. Under these circumstances, it is expected that the spatial variance of pressure across the length of the room at the frequency of the first mode is reduced. Evidence of this may be obtained by predicting the pressure across the room at its first eigenfrequency. This is shown in Figure 5.14.

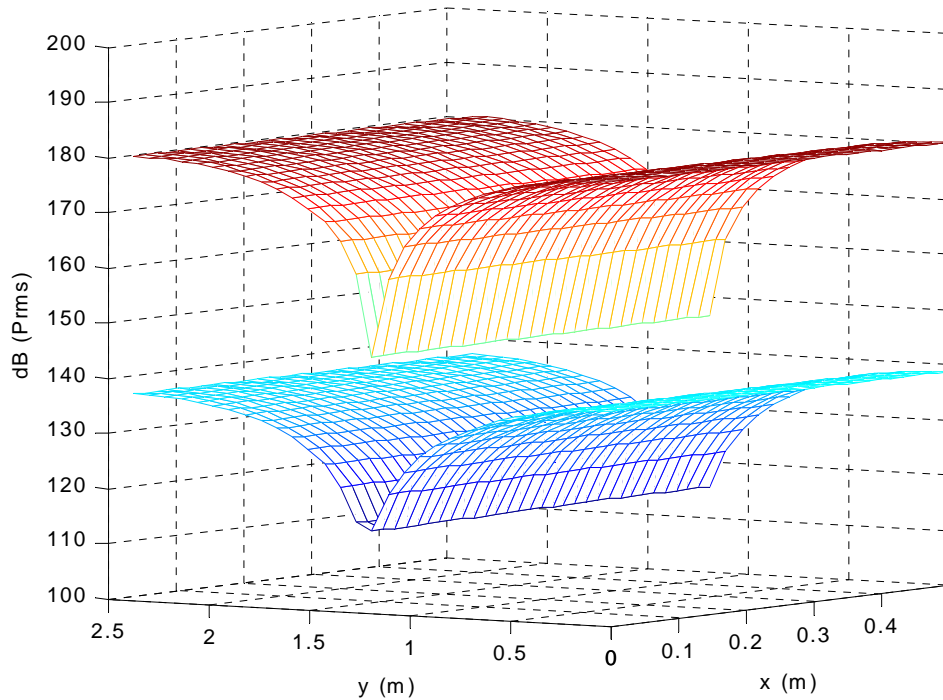

Figure 5.14 – Variation of pressure in a rectangular duct predicted at the first axial mode (72 Hz). The top plot shows the response to point source excitation. Bottom plot shows the response to simply supported plate with the 3rd eigenfrequency of the plate matching the first axial room mode.

It is clear that the pressure difference between ‘loud’ and ‘quiet’ zones at the first room mode has been reduced when using the plate as a radiator. Furthermore, this decrease in variation corresponds to approximately 12 dB, which may be considered an improvement. However, further observation of Figure 5.13 reveals that at 55 Hz there is a large resonance introduced by the first eigenfrequency of the plate. In conclusion, although this case appears to reduce the excitation of the first room mode, the effects of introducing a large amplitude peak in the magnitude response are certainly disturbing.

Hitherto, the simulation results have been analysed in terms of the changes obtained in the magnitude frequency response. However, and as referred in 5.2.3, the control of a room resonance should also be revealed by a reduction of its decay rate. The results so far have been presented as simulations of the steady-state magnitude response of the room. Hence, no information has been given on the obtained decay rate of the sound field. This decay information is inherent on the complex frequency response determined for the room. Extraction of the decay rates is therefore possible by transforming the complex frequency response using appropriate inverse Fourier techniques to obtain the corresponding impulse response of the system. The T_{60} reverberation time may then be determined from this. The extraction of reverberation time from the impulse response was obtained using a dedicated room acoustic analysis software (ramsete).

Table 5.3 shows a comparison of the decay times obtained for the two simply supported cases above and contrasted to results for point source excitation.

Table 5.3 – Decay times in seconds for the sound field in a duct when excited by two different simply supported plate configurations. The eigenfrequencies on the plate are adjusted so that a specific match is obtained with the frequency of the first room mode. Mode 3 corresponds to the third eigenfrequency of the plate matching the first room mode. Mode 2 corresponds to the second plate eigenfrequency matching the first room mode. Results are contrasted to point source excitation.

Source Case	Octave Band	
	63 Hz	125 Hz
Mode 3	1.27	0.97
Mode 2	0.90	0.87
Point Source	0.95	0.99

The original damping characteristics of the room model were determined using a reverberation time set to one second, and this is confirmed by the results obtained for the point source, which lie close to this value. Interestingly, the case where some control appeared to be achievable considering the reduction in magnitude level (Figure 5.13 *mode 3*) is the one with a longer decay time. This could be construed as emerging from the large under-damped resonance that the plate introduces at its first eigenfrequency (~55 Hz). In this case, the original decay time of the room at the 63 Hz octave band is further increased by approximately 0.27 seconds due to the plate resonance, which is certainly not an improvement in terms of modal control. Even though the spatial variation of pressure at the first room mode is beneficially reduced (Figure 5.14), this plate case does not translate into a desired reduction of the decay rates in the room at the low frequency range.

The *mode 2* case appears to be the one introducing a larger reduction in decay time when compared to point source. A reduction of around 0.1 second is achieved at the two octave bands. However, in terms of excitation of the first room mode, this appeared to be the worst case in the magnitude frequency response (Figure 5.13), and would correspond to a larger spatial variation of pressure levels at the first room eigenfrequency. This fact raises important questions about the usefulness of steady-state magnitude response in providing information about the quality of modal sound-fields.

It appears, that using these distributed mode sources, a reduction of the peak level and consequent spatial pressure variance of a room mode may be achievable but at the cost of introducing longer decays created by under-damped resonances in the source.

Hitherto, the study of plate room interaction has concentrated on matching specific plate mode-shapes with axial modes in a duct. Furthermore, the effects of plate damping on the overall room response have not been investigated. Additionally, and as suggested in section 5.3, one of the benefits of using distributed mode sources for the excitation of low frequencies is that the

effective radiating position of the source changes with frequency. Indeed, this characteristic is most noticeable at the higher modes of radiation from the plate (Fahy 1985).

Another study was thus carried out using a prediction model of a real size reverberant room (introduced in Chapter 3), where a large simply supported plate is defined to cover an entire wall of the room. The plate parameters are defined so that its full modal behaviour is at the modal region of the room. This is obtained by adjusting the elasticity modulus of the plate so that its first eigenfrequencies are very low – starting at about 10 Hz. Shown in Figure 5.15 are two cases of a simply supported plate with high and low damping, contrasted to point source excitation.

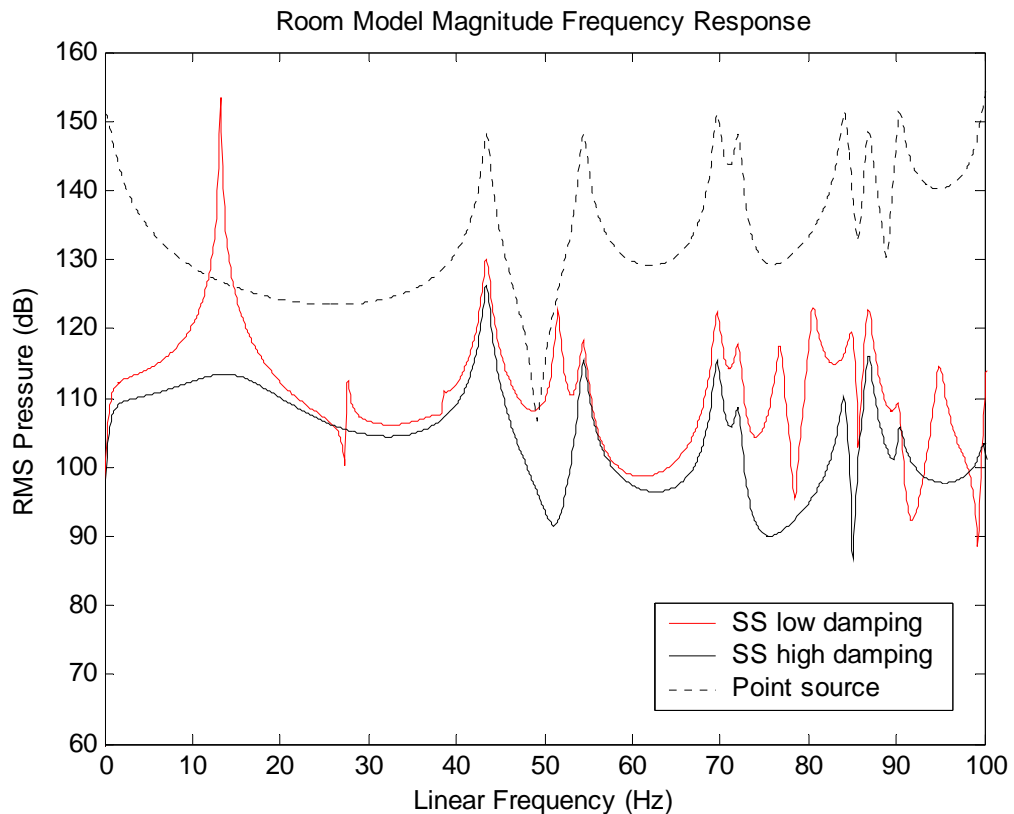

Figure 5.15 – Comparison of modal sound field in a rectangular room for point source defined at one corner and simply supported plate defined to cover one wall. Two plate damping settings are shown. Response position is defined at opposite corner.

Although rather more complex, the main features observed in the simpler case of a duct are still evident in the plots shown in Figure 5.15. The magnitude responses resulting from a lightly damped plate (shown in red) show more resonances. Because of its lower damping the plate introduces its own inherent resonances, which results in an increased modal density. Strong excitation of the expected room modes is still obtained because the radiation of the plate is happening mainly from its edges or corners, positioned at high pressure regions in the room, therefore coupling into them efficiently.

The result obtained for a plate with high damping (shown in black trace) is very similar to that obtained for point source excitation (shown in dashed black trace). As mentioned previously, a highly damped plate behaves similarly to a finite disc due to the localization of the source on the position of the exciter on the plate (Avis et al. 2000). In this case the plate behaves similarly to a point source, where the source location corresponds to the exciter position on the surface of the plate.

Therefore, the use of highly damped plates does not appear to improve the excitation of the modal sound-field when compared to point source excitation. Furthermore, the increased damping on the plate reduces its radiation efficiency (Angus 2000) and thus practical applications as radiators are compromised.

Following assumptions from work on modal distribution (Louden 1971; Bonello 1981; Walker 1992; Cox et al. 1997), the density of resonances in frequency is considered important in avoiding the detrimental effects of room modes. Angus (1999) also suggests the use of low frequency diffusers to increase modal density in a room. Indeed, room modes are not considered a problem in auditoria given that the density of resonances at the lowest auditory range is very large. The introduction of extra resonances in the modal sound field of a room using lightly damped plates as low frequency sources could thus be regarded as beneficial. Such a system could be used to increase the low frequency modal density and ‘fill in’ the gaps between the original room modes. The subjective implications of this idea will be examined in Chapter 6, where an investigation on the subjective perception of changes in modal distribution is carried out.

Similar to the previous case for a rectangular duct, the results obtained have been translated into octave band decay times. These are shown in Table 5.4 for the three cases depicted in Figure 5.15.

Table 5.4 – Corresponding decay times, in seconds, for a prediction model of a real size room. Two different simply supported plate cases are contrasted with point source. The effects of plate damping on the low frequency decay are shown.

Source Case	Octave Band		
	31.5 Hz	63 Hz	125 Hz
SS low damping	6.99	3.50	2.98
SS high damping	3.00	3.00	3.03
Point Source	3.00	3.01	2.95

The room damping in the model for this prediction was set to correspond to a value of reverberation time of 3 seconds. The results for the point source confirm this.

As observed previously, the decay rates obtained for the simply supported source with low damping introduce longer decay rates. These are associated with the high Q resonances inherent

in the plate, especially at the very low frequencies, where decays are longer. If the damping on the plate is increased the decay response is reduced, and is indeed very similar to point source excitation. No further reduction of the decay times is achieved in any case. The impulse responses for each case when the plate is used as a source may be seen in Figure 5.16.

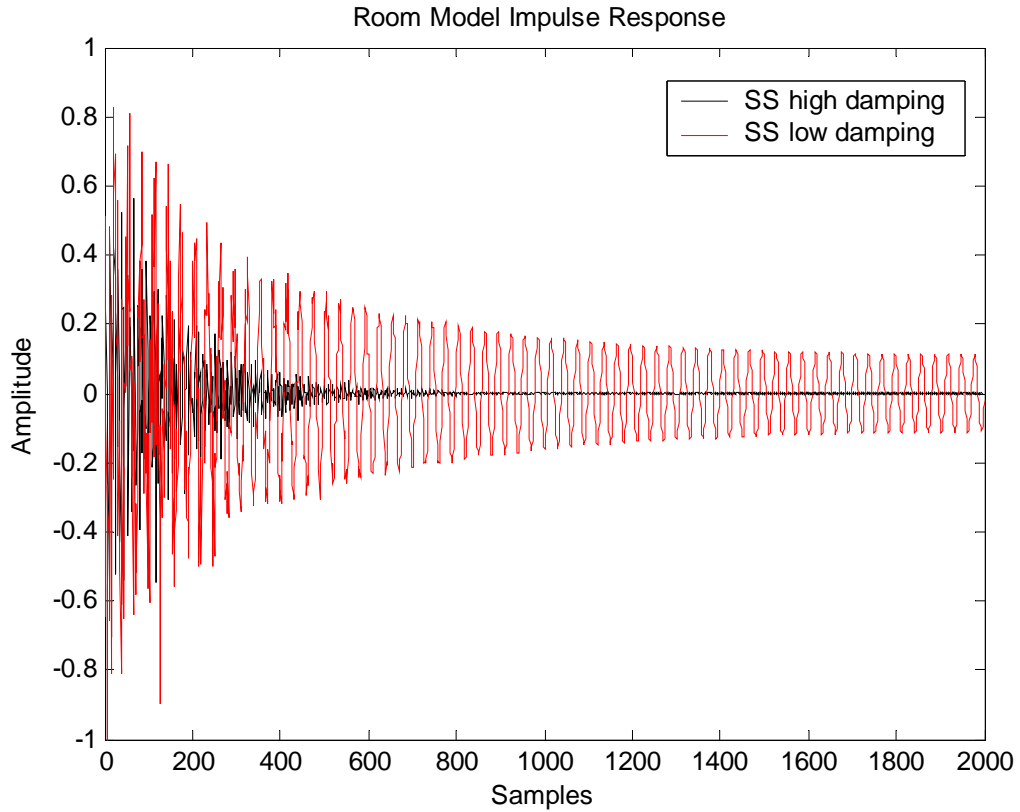

Figure 5.16 – Impulse response for model of real size room when using a simply supported plate as a source. Two plate damping cases are shown.

It is clear that the lower damping case is associated with a very long decay rate. Indeed, careful observation of Figure 5.16 shows that the later part of the decay is dominated by a single frequency, clearly visible as the high Q-factor resonance at around 13 Hz in Figure 5.15.

These results show that highly damped plates will interact with modal sound-fields in a similar way to point sources, therefore achieving no controllable benefit in the excitation of modal sound-fields. Conversely, lightly damped distributed sources may effectively increase the modal density of a sound field. However, the long resonant decays originated by the under-damped plate resonances may deteriorate the overall response in the room.

Once again, the duality of information obtained from the displays of data describing the modal sound field of a room indicates that the measures of frequency and time, should be treated with caution when used for analysis and control.

5.4 Summary

A study was carried out on two methods to control room modes and their suitability for the treatment of low frequency reproduction was identified. This study into practical applications of modal control has provided a better understanding of the mechanisms underlying resonances in rooms and their effects on descriptors such as frequency and decay responses, which may be linked to subjective perception.

The first method investigated the use of passive resonant absorption as a technique to reduce the reverberation time in two critical listening spaces. It was shown that resonant membrane absorbers provide some control over the decays of modes, by coupling into their mode-shapes and reducing their energy. This is translated into a reduction of the resonance quality factor, which has been shown in some cases to induce a perceptible change. It was further identified that in order to achieve total control of the modal sound field, larger areas of absorption would be necessary at each problematic frequency range, providing more substantial reductions in the decay rates. As such, this application has provided improvement but not a total elimination of the problem.

Based on approaches found in rooms where light wall partitions aid in obtaining a less problematic modal sound field and borrowing ideas from optimisation of source location to control the excitation of modes, a second investigation was carried out which utilised vibrating plates to generate low frequency sound in the room. The basis for this investigation originated in indications from scale model measurements, where plates are shown to generate a different excitation of the modal sound field when compared to conventional point sources.

A study using prediction models for radiating plates in rooms was then undertaken. Analytical solutions providing the response for a rectangular plate with simply supported boundary impedances in a room were derived. A prediction model based on the superposition principle was also used to calculate numerical solutions for the interaction of plates with more complex boundary conditions.

Results obtained for a one dimensional room model have shown that distributed type sources excite modes in a different way to point sources. It was identified that the distributed nature of the source accounts for these differences as indicated in the case of a piston moving plate when placed along the dimension of the modes to be controlled. Furthermore, if the radiation pattern of a distributed mode source is controlled to match a certain eigenfrequency of the room, a substantial reduction of excitation at that frequency is achieved with a consequent decrease in the spatial pressure variation. This is however counteracted by the introduction of high Q-factor resonances originated in the plate which lead to long undesired decays in the overall response.

Prediction results for real applications further indicate that distributed mode sources can introduce closely spaced resonances, generated by the modal behaviour of the plate, and consequently increase the modal density of the sound field. This is shown to be dependent on the damping conditions of the plate material. The use of such a system appears viable in order to increase the modal density in a room, which has been suggested to improve listening conditions at low frequencies. However, control over the decay of plate resonances is difficult, and results show a detrimental increase of the overall room decay.

The duality of information provided by frequency and time responses of rooms appears sometimes contradictory. Examples of this were demonstrated with the use of passive membrane absorbers, where small changes in magnitude frequency response and considerable variation of decay times were measured in the same room. This alerts for the dangers of considering only part of the information, e.g. magnitude frequency plots, when analysing systems that may have resonant components that are only described if temporal aspects are also taken into account.

Furthermore, these findings raise important questions regarding the perceptibility of factors related to room modes. Specifically, the alterations in frequency and decay responses measured in the rooms are expected to produce perceptible effects, but the perceptual extent of these are still largely unknown. It follows thus that an investigation into subjective factors such as modal distribution, frequency response and decay time of resonances will not only provide a further understanding on the extent of these effects on users' perception but also guide treatment methods onto the objective factors which are more likely to impart perceptible changes. The critical importance of such factors is investigated in Chapters 6, 7 and 8.

6 Subjective Perception of Modal Distribution – Dependence on Room Aspect Ratios

6.1 Introduction

It was demonstrated in Chapter 5 that a system based on a distributed radiating source may effectively increase the modal density of an enclosed space. Whilst the feasibility of this technique remains dependent on plate parameters that may be difficult to implement using real materials, it nevertheless raises important questions about the subjective effects of an increased modal density in the room. Furthermore, other authors have referred that changes or increases of the modal density may improve the reproduction quality of a room (Louden 1971; Bonello 1981; Walker 1992; Cox et al. 1997, Angus 1999 b). As a consequence, design techniques have been developed to prevent the ‘clustering’ of room modes and optimise the modal distribution by defining appropriate room aspect ratios prior to construction. Subsequently, lists and charts of aspect ratios have been published that describe the low frequency acoustic quality of rooms based on metrics derived from their modal distribution (e.g. Louden 1971; Irvine et al. 1997). The aim of this chapter is to investigate the subjective perception of changes in modal distribution with specific focus on the validity of these metrics.

6.2 Modal density and distribution

As mentioned in Chapter 3, the analysis of a room response has often been divided into a modal region where there is low density of modes which are well separated in frequency, and a higher frequency region where the large number of overlapping modes allows the response to be analysed using statistical methods. The line of reasoning behind this assumption is that, above the Schroeder frequency, there are a sufficient number of resonances within one critical bandwidth to render the effects of room resonances inaudible (Howard et al. 1998). It could be argued thus that the introduction of extra resonances that ‘fill in’ the frequency gaps between adjacent modes at low frequencies may reduce their audible effects. Furthermore, increased modal density at the lower audible frequencies is physically associated with larger spaces (e.g. Howard et al. 1998) such as concert halls or auditoria where the modal sound field is diffuse due to the larger number of overlapping resonances. Hence, an increase in the lower frequency modal spacing may induce the percept of a ‘larger room’.

The modal distribution of a room refers to how the resonant frequencies are distributed over the low frequency range. It is directly associated with the dimensional aspect ratios of the room.

Optimum modal distributions are usually associated with a distribution of the eigenfrequencies in such a way as to avoid large amplification or attenuation of sound at specific frequencies where modes overlap (modal degeneracy) or cancel out.

Methods have been developed (Louden 1971; Bonello 1981; Walker 1992; Cox et al. 1997) that rank room aspect ratios according to a figure of merit based on their modal distribution. In some of these investigations (e.g. Louden 1971) a list is suggested that describes aspect ratios along with their figures of merit on a continuous ‘quality’ scale. Such lists of room ratios have been suggested as a guide for room designers who may thus choose from a multitude of possible configurations that are ordered according to their acoustic ‘quality’. Other researchers (e.g. Cox and D’Antonio 1997) have also made use of such ranking of aspect ratios, albeit indirectly. In this case, optimisation methods to improve room low frequency response according to alterations in aspect ratios have been developed.

In practical cases, it could be desirable to determine difference limen for these descriptors of room quality. These could then be used as subjectively meaningful target for design or optimisation procedures. However, in order to determine these difference limen it is important to demonstrate that a continuous list of values of a certain descriptor has a direct relationship to its perceived quality.

The study presented in this chapter identifies the subjective perception of two general types of modal distribution metrics identified in literature. The objective is to classify their relative significance in the perception of low frequency resonances. Hence, experimental tests were set up to evaluate differences between three room conditions, differing in aspect ratios, that score extreme classifications in each of the metrics.

Two different experiments were carried out. The first experiment tested for detection according to both metrics and the dependence on different music styles – Pop, Jazz and Classical. The second experiment tested for differences introduced by changing the frequency content of the original audition sample.

6.3 Metrics

The metrics under study assess the distribution of room modes in frequency and help the designer to decide on room dimensions that avoid worst situations and aim for an ‘optimum’ distribution of the eigenfrequencies (Louden 1971; Bonello 1981; Cox et al. 1997). The metrics used in this investigation represent the two main groups found in literature. One group uses the frequency spacing between centre frequencies of all possible modes supported in a rectangular room and calculates a figure of merit derived from this (Louden 1971; Walker 1992). The other

group takes into account the full pressure response at one point in the room and calculates the figure of merit based on the deviation to a target magnitude pressure curve (Cox et al. 1997).

The metric based on the pressure response, and hereafter called *Metric 1*, is determined from a magnitude frequency response predicted (or measured) at one specific point in the room. This is the common frequency response plot for a single position in a room and it may be obtained from the Green's function of the system under study. The figure of merit in this case, is calculated as the deviation from a constant amplitude or flat frequency response (Cox et al 1997).

The metric based on the pressure response, takes into account and requires information on the source and receiver positions, as well as the damping characteristics of the room, which will affect the Q-factor of the modes. The level of damping included in the prediction models has to be low due to assumptions already discussed in Chapter 3. This is nevertheless inline with real room conditions, where low frequency absorption is usually small. Interaction between adjacent modes is also inherently included in this metric and appears as resonances or anti-resonances in the frequency response.

Figure 6.1 shows frequency magnitude predictions for two rectangular rooms with the same volume but different aspect ratios. It is clear that there are major alterations on the frequency response induced by the change in room aspect ratios.

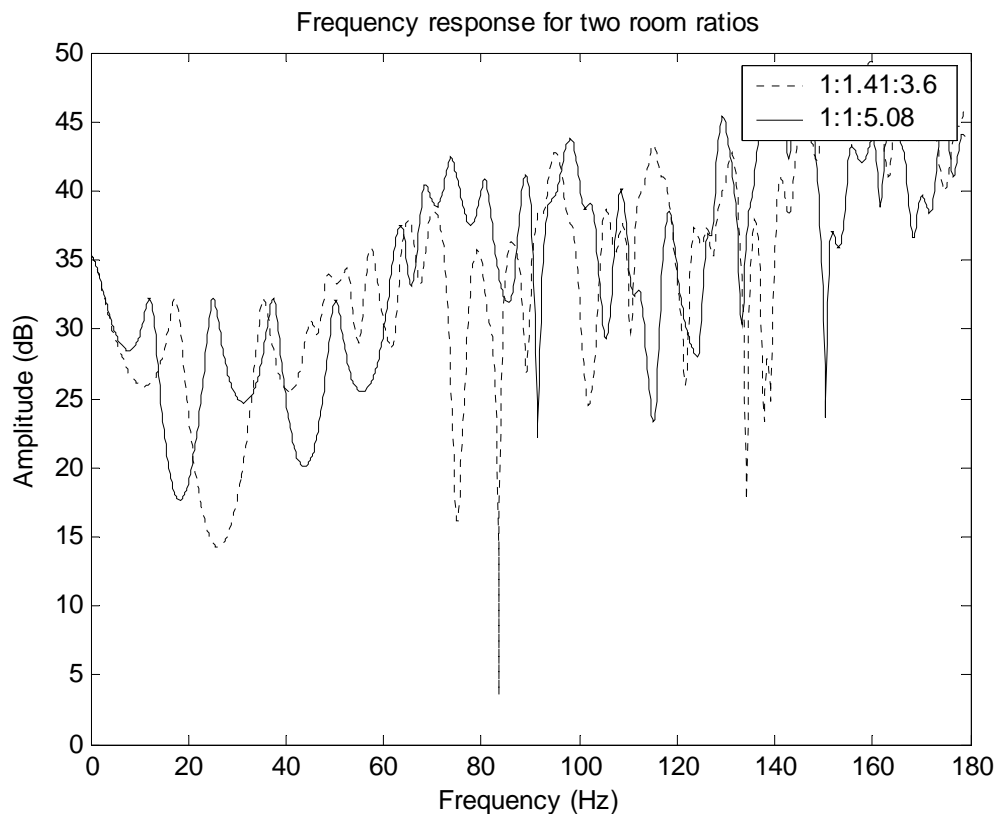

Figure 6.1 – Performance for two rooms on *Metric 1* based on pressure distribution.

From the plots in Figure 6.1 it is not clear which ratio scores best on this metric. In fact these two rooms that score very different values on the *Modal Spacing* metric (described as follows) have a very similar score on the *Pressure Response* metric.

Metric 2 is based on *Modal Spacing* and takes into account the frequency spacing between adjacent modes and its deviation from an ideal modal distribution (Louden 1971). This ideal modal distribution is calculated from an expression (Equation 6.1) that determines the inverse of the expected number of modes per bandwidth as would be characteristic of a large space free from the problems of room modes (Bolt 1939).

$$\delta F / \delta N = \frac{1}{\frac{4\pi F^2 V}{c^3} + \frac{\pi F A}{2c^2} + \frac{L}{8c}}$$

Equation 6.1

where

$$V = L_x L_y L_z$$

Equation 6.2

$$A = 2(L_x L_y + L_x L_z + L_y L_z)$$

Equation 6.3

$$L = 4(L_x + L_y + L_z)$$

Equation 6.4

and V is the volume of the room, L indexed corresponds to each room dimension, A is the total area in the room and F is the centre frequency of the band.

Equation 6.1 indicates the average frequency interval between two neighbouring modes which may be assumed to be representative of diffuse conditions. According to this expression the detailed frequency spacing between modes is dependent on the room volume and room shape. Real conditions in small rooms reveal modal spacing characteristics which differ substantially at the lower frequencies, but as frequencies increases the response becomes less dependent on the specific shape of the room and the larger density of modes approximates those predicted by the above expression. This metric, by its nature, does not take into account the source and receiver positions in the room or indeed the residual interaction between adjacent modes. The relative level of each resonance is thus unknown, and detailed knowledge of the acoustic characteristics of walls, floors, etc. is not required.

Figure 6.2 shows the modal spacing characteristic of two rooms that score extreme values on this metric. This is contrasted to the ‘desired’ modal spacing for each room as calculated using Equation 6.1 above (labelled as Desired 1 and Desired 2).

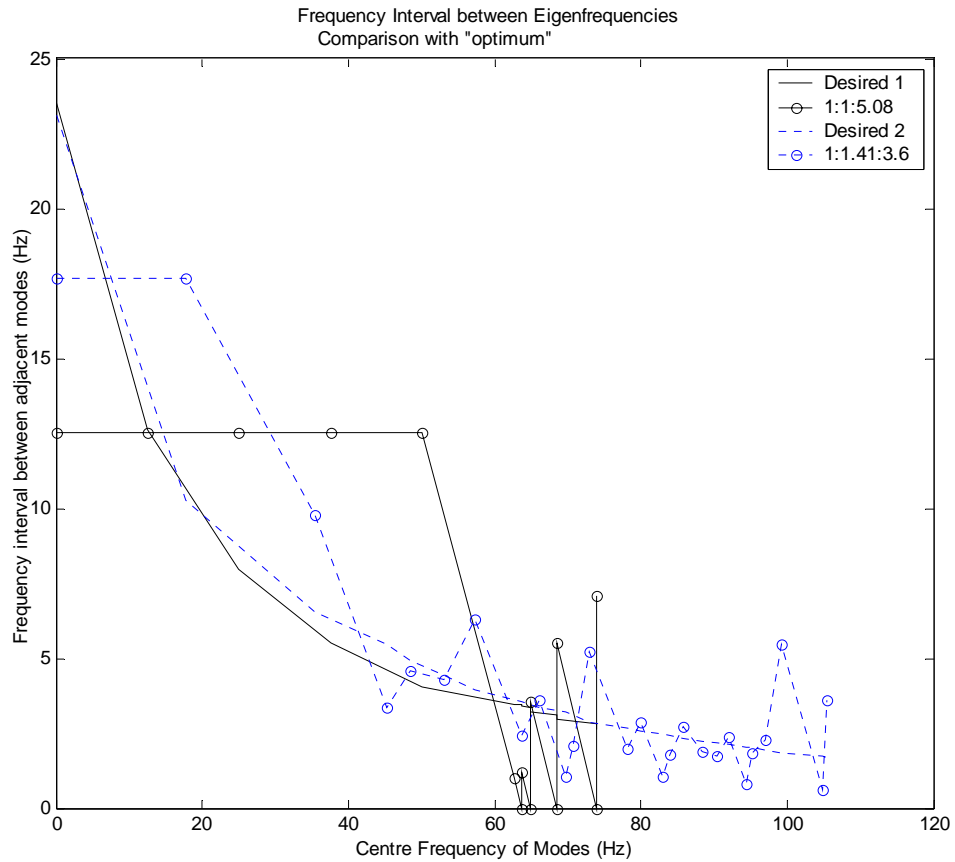

Figure 6.2 - Performance for two rooms on Metric 2 based on modal spacing.

The figure of merit in this case is defined as the average standard deviation from the line with markers (the calculated distance between modes) to the smoother line (representing the ‘desired’ distance between modes). From observation of Figure 6.2, it can be seen that the room ratio 1.41:3.6:1 achieves a better score in this metric as it deviates less from the ‘desired’ spacing between adjacent modes. This plot also indicates that this ratio produces no degenerate modes as there are no zero values.

Figure 6.3 shows a plot with the scores of various room ratios according to each metric. These were generated by varying the x and y dimension ratios from 0 to 3 in steps of 0.01, and fixing z at 1. The volume is fixed at 100 m³. This population spans all the possible room ratios within this range. The corresponding scores in each metric were determined. The results were arranged in ascending order for the *Metric 1* (Pressure Response) and plotted against *Metric 2* (Modal Spacing). Figure 6.3 shows the relationship between two metrics. Higher values are associated with ‘worst cases’.

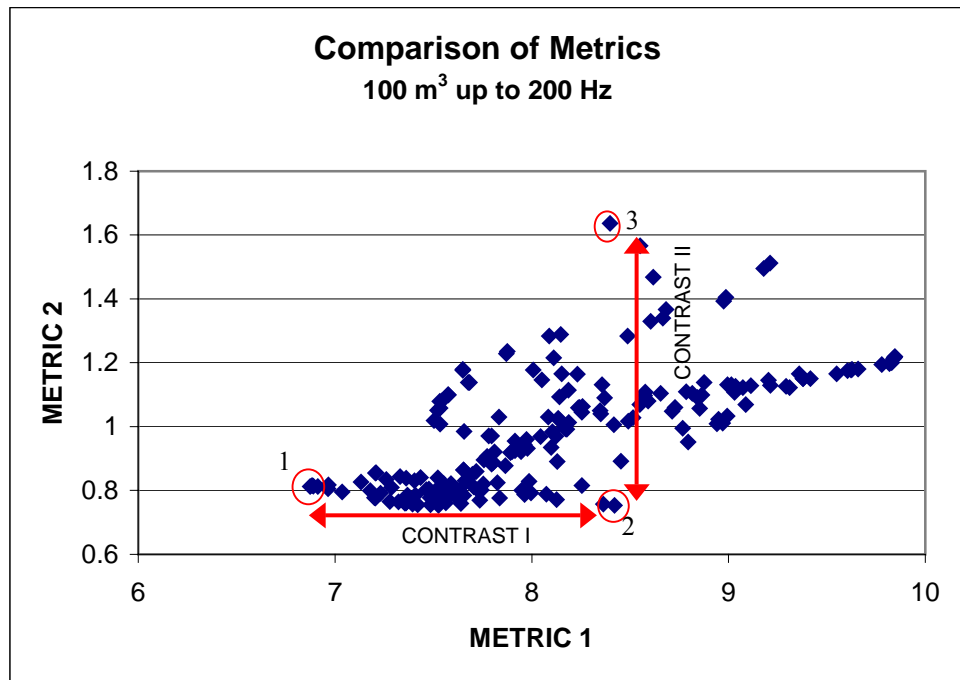

Figure 6.3 - Comparison of the two metrics under study.

The scatter of data on Figure 6.3 indicates that the two types of metric are not linearly related. The experimental method presented here focuses on identifying which of the metrics is most closely related to the detection of changes in modal distribution. Comparisons were then selected to test for detection of differences between specific room conditions. With this aim, three room ratios were selected according to their scores in each metric. Each of the comparisons, room 1 vs. room 2 and room 2 vs. room 3, represents a large variation according to one metric and a small variation according to the other. These are indicated in circles and numbers in Figure 6.3.

The experimental hypothesis states that if one of the metrics is more closely associated with the subjective perception of changes in modal distribution, then subjects should detect differences in one of the comparisons but not in the other. Hereafter the cases studied will be named according to the metric in which the two rooms compared score a large variation. Thus **Contrast I** refers to comparing room 1 vs. room 2, and **Contrast II** refers to comparing room 2 vs. room 3.

A table containing relevant information for each room as well as the respective score on each of the metrics is given below.

Table 6.1 – Room ratios under study and corresponding score on each of the metrics. Metric 1 has values for standard deviation from a constant pressure level. Metric 2 has values for standard deviation to 'desired' modal distribution as defined by Bolt (1939).

Room	Ratio	Metric 1	Metric 2
1	2.58:1.97:1.00	6.87	0.81
2	1.41:3.60:1.00	8.36	0.76
3	1.00:5.08:1.00	8.4	1.63

A plot of the low frequency response of room 1, corresponding to a ratio of 2.58:1.97:1, is shown in Figure 6.4.

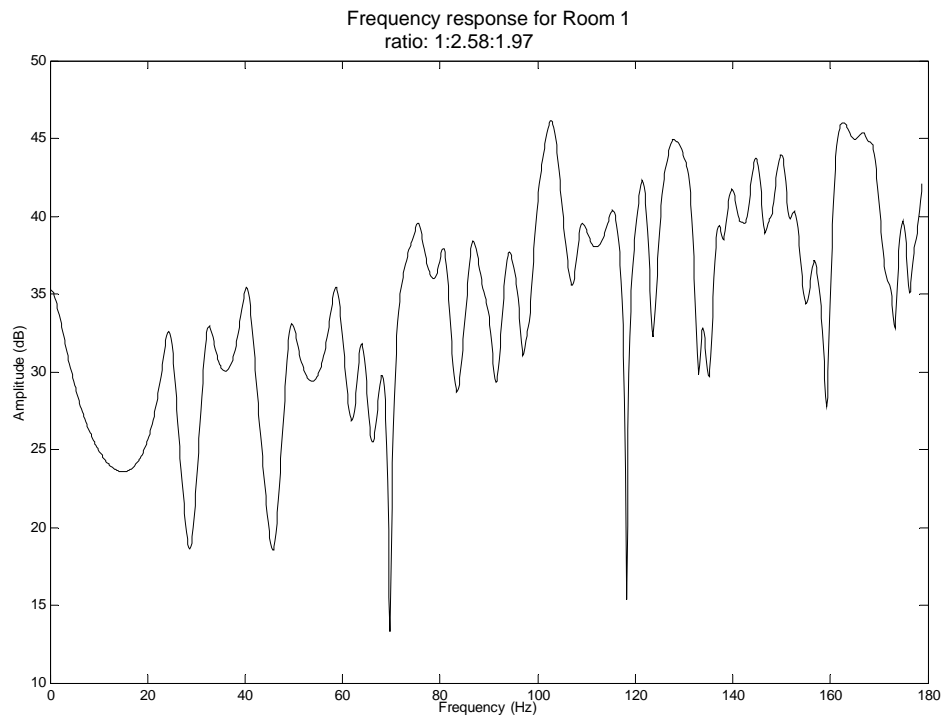

Figure 6.4 – Magnitude pressure response for room 1.

The variables for the test have been decided and three room cases have been chosen according to their scores on the two metrics under study. In order to test for the detection of differences and evaluate the perception of changes in the modal distribution of rooms, an experimental method has been established, and is described in section 6.5.

Section 6.4 describes, important issues regarding the binaural presentation of samples and, their preparation. This general model is used throughout the subjective tests presented in Chapters 6, 7 and 8.

6.4 Binaural model of a listening space

One of the major problems in subjective tests for room acoustics has been the difficulty in changing acoustic conditions swiftly (Niaounakis and Davies 2002). The removal and introduction of large items to control the acoustic sound field in rooms is invariably time consuming. Altering the acoustic conditions whilst maintaining the waiting time between auditions to a minimum has always been a crucial requirement given the relative short ‘acoustic memory’ of subjects (Borwick 2001). The experiment presented here explores the use of binaural reproduction over headphones to overcome this problem. It uses a virtual representation of a real room. This is created by the use of binaural recording techniques added to the analytical model of the room at low frequencies described in Chapter 3. This approach enables the presentation of different low frequency acoustic conditions in sequence, without changing the high frequency conditions.

The creation of the audition samples is divided into two main parts associated with a division of the audible frequency spectrum. These will be referred to as *low* and *high frequency* regions. As defined before, the dividing point between them is determined by the Schroeder frequency of the room in question. The Schroeder frequency for the rooms used was determined at $f_s=200\text{Hz}$ using reverberation time conditions measured in the real room where the high frequency binaural recordings were obtained. The musical test signals used are mono versions of extracts taken from commercially recorded compact discs. It is not a requirement to use anechoically recorded samples as the experiment investigates the effects in audio reproduction rooms. It is therefore correct to use material similar to what is usually reproduced via loudspeakers in these rooms.

A diagram describing the generation of the audition samples is given in Figure 6.5.

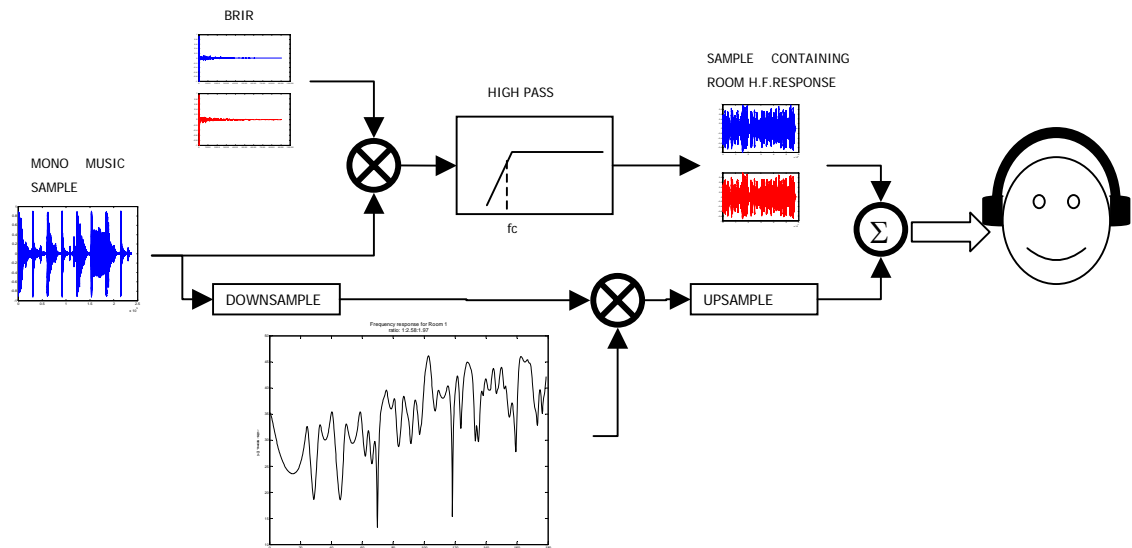

Figure 6.5 – Schematic for the generation of audition samples.

The audition pairs are presented via headphones in a quiet, but not necessarily isolated environment. Because changes in the low frequency region of the samples affect their perceived loudness level, and because this is an important and extraneous psychoacoustic cue, all samples have been normalised to the same A weighted level.

The audition level was set at 78.1 dB(A) SPL, and this has been maintained for all ensuing tests. This level was calibrated at the microphones of the B&K Head And Torso Simulator (dummy head) and using a B&K 2231 sound level meter. The audition level is dependent on computer soundcard level output and was chosen to be close to 80 dB(A), which represents a comfortable and usual listening level in professional situations.

6.4.1 High frequency binaural impulse responses

It was decided to maintain a fixed and pre-determined high-frequency component of the auralisation samples, whilst manipulating their low frequency characteristics. A head and torso simulator was used to measure binaural room responses in a real size audio control room. These were used as the starting point for the design of the room auralisation on which the subjective test was based. The high frequency content of the audition samples contains spatial and temporal information, which is crucial to the sensation of listening in a real room, and this data was obtained directly from the measured binaural impulse responses (BRIR).

A binaural impulse response of a room with a low reverberation time (0.2 s) was measured at the normal listening position in the control room described in 5.2.1. This reverberation time corresponds to an average taken from measurements in the 250 Hz to 8 KHz bandwidth measured in the room. The BRIR is then convolved with the input signal. At this stage the low frequency modal behaviour of the measured room is still present from the original BIRs. This

part of the response is removed using a Butterworth eighth order high-pass filter with a crossover frequency determined by the Schroeder frequency. An eight-order filter was selected due to its steep rejection slope, adequate for the filtering of the low frequency response. Care was taken to identify if the high order of the filter resulted in unwanted audible artefacts. No evidence of this was found.

6.4.2 Low frequency model

After filtering the original low frequency content present in the binaural samples it is then necessary to re-create the controlled low frequency part of the room model. This is generated using a computer model based on the modal decomposition technique described in Chapter 3. The use of such model is based on the assumption of orthogonality, which is not satisfied under large damping conditions, also as discussed in Chapter 3. The sound fields generated for the experiments in the present chapter assume low damping, and therefore the assumption is not violated. In further studies presented in Chapters 7 and 8, this underlying assumption is not always true and the implications are discussed further in the relevant sections.

The low frequency response of the room is predicted for specific source-receiver locations (Figure 6.4 shows an example of the magnitude response). This is then converted into an impulse response using a method based on the inverse Fourier transform. This impulse response effectively describes the behaviour of the source-room-receiver system at low frequencies. The response is finally convolved with a down-sampled version of the input signal to obtain the low frequency region of the audition sample. The resampling of the original mono signal is carried out using the *resample.m* function in MATLAB, which employs a FIR⁶ anti-aliasing low pass filter.

A point source is located at a room corner, and the response is determined for a receiver at the opposite corner. Although this choice could be criticised on the basis of deviation from normal listening conditions, most mode-shapes have maximum amplitude in the room corners; therefore a fair comparison with the *modal spacing* metric is more likely than would be the case if locations are chosen which imply non-excited or non-observed modal contributions.

In the model, the necessary adjustment of the decay time at low frequencies is set at $RT = 0.8$ seconds. This information was gathered by measuring the RT in the physical room used to record the high frequency content of the samples. This value corresponds to the average decay measured at the 63 Hz octave band and represents a situation that may be commonly found in small rooms of hard wall construction. This value of RT is used to determine the damping factor in the model using Equation 3.2.

⁶ Finite impulse response

6.4.3 Audition samples

After re-sampling the low frequency region to the intended sampling rate, the low and high frequency parts of the sample are added to produce the full range audition sample. The output of the model is compared with an analogous measurement taken in the real room, and subsequent gain calibration between low and high frequency levels is determined. Figure 6.6 shows the output of the model compared to the measurement taken in the room.

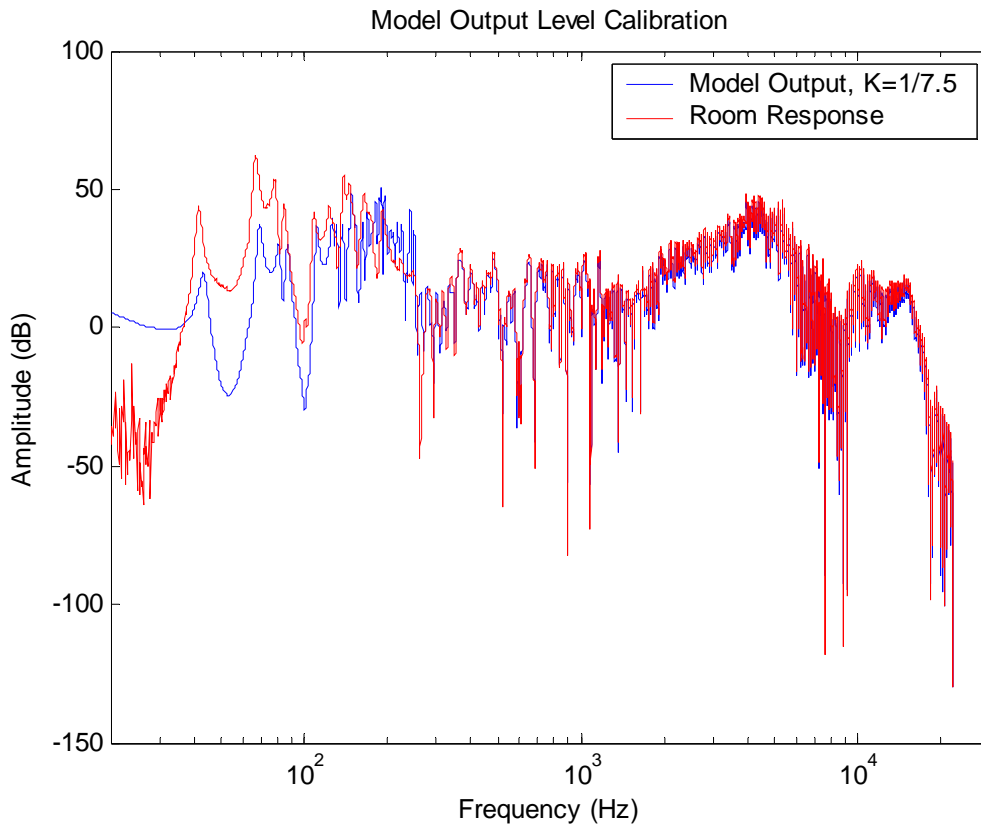

Figure 6.6 – Calibration of prediction model output levels, adjusted to similar conditions in the real room.

Special attention was given to match the levels to the same order of magnitude at the crossover frequency between high and low frequencies. This was done in order to avoid any noticeable cues at this region that could provide a ‘wrong’ trend in the detection tests. No further corrections were applied.

6.4.4 Headphone reproduction

The experiment was carried out using binaural samples presented over headphones. The headphones used for these experiments were tested for their frequency response. Figure 6.7 shows the frequency response of the Sennheiser HD600 headphones measured on a B&K type 4128c head and torso simulator. The curve shows the response of the right side transducer on the range 0 to 500 Hz.

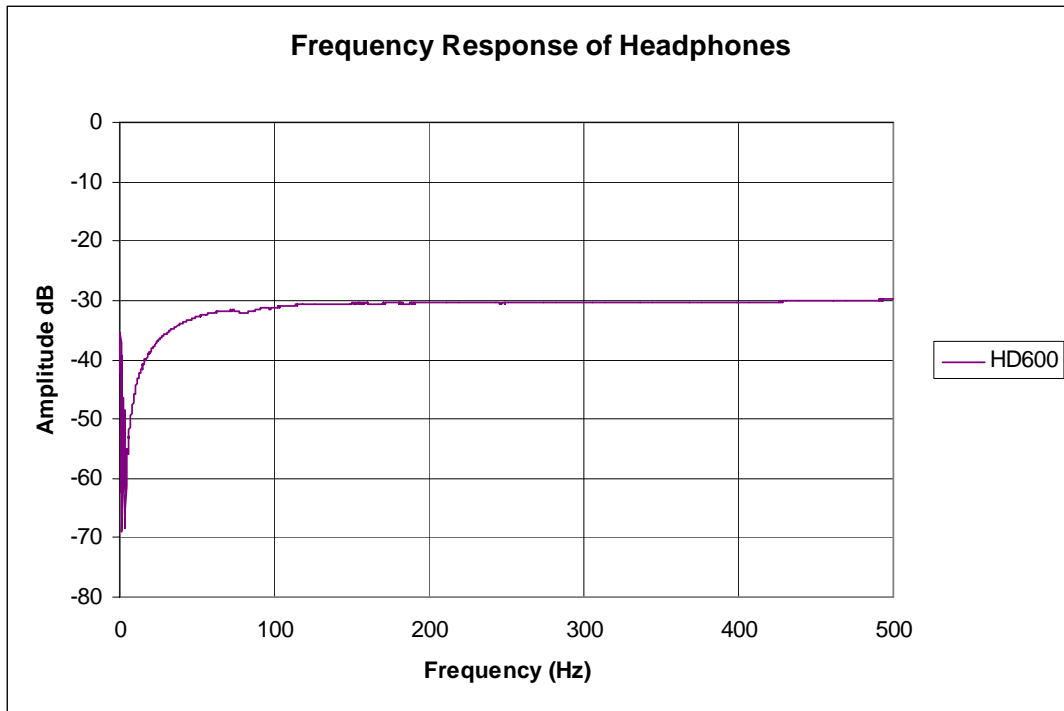

Figure 6.7 – Frequency response of Sennheiser HD600 headphones measured on B&K type 4128c Head and Torso simulator.

The response of the headphones is satisfactory down to 40Hz, showing no apparent problems in the magnitude frequency response. No correction curve for the effect of the headphones was included in the model.

6.5 Test method

The subjective experiment tests if subjects are able to distinguish between two conditions. In the case of the tests presented in this chapter, these conditions correspond to two rooms with different aspect ratios. If the test hypothesis is confirmed, the rooms that score different values on one of the metrics will originate most of the detected differences, and a correlation between that specific metric and the subjective perception of modal distribution may be extrapolated.

In practice, an ABX type of test was used. This consists of presenting each subject with a pair of samples A and B, which represent different room acoustical conditions. An unknown sample, X, is also presented at each trial. The task is for the subject to decide whether sample X is either A or B. A number of 16 trials were performed in order to ensure sufficient level of data for the ensuing statistical analysis. Sample X is randomised for each trial whereas samples A and B remain the same for each run. This test is implemented in software using previously prepared binaural music samples. A readily available software provides the user interface as shown in Figure 6.8.

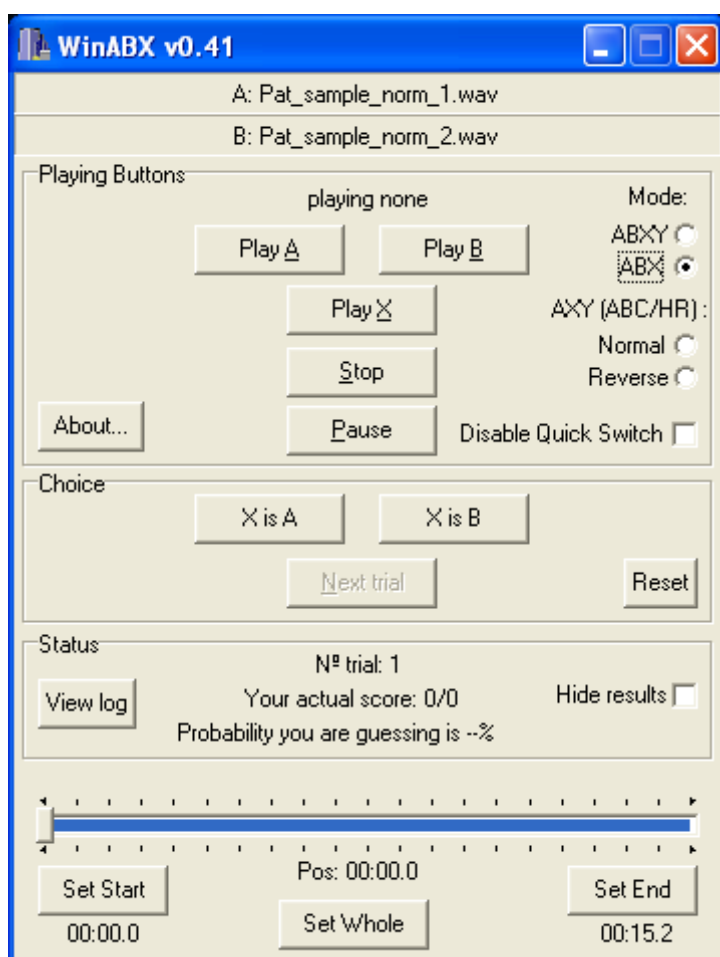

Figure 6.8 – ABX test software interface. www.pcabx.com.

At this point it is important to define some important issues on experimental subjective testing and more specifically on A vs. B type of comparisons. The test should be repetitive, and in this case, to gather sufficient data for statistical analysis, a total of 16 trials were carried out for each run, for each subject. This reduces the number of subjects required and ensures that significant detection of differences is identified using statistical methods. In order to reduce errors, the tests are blocked in paired comparisons. Confounding factors are held constant, such as the loudness level, the high frequency content of samples and the headphone response. Other sources of discrepancy, such as training and fatigue, are ‘forced’ to contribute randomly to the experiment by varying the presentation of pairs and controlling the experimental duration.

For each subject, a figure of correct responses is noted and entered into a table for later statistical analysis. A log of the responses for each subject is kept to check for performance or extraneous effects such as learning. At the end of each *run*, the subject is asked to comment on any points that s/he may find relevant, especially if there was any particularity on the samples that was providing the difference ‘cues’. Unless otherwise stated, all ABX tests carried presented in this thesis were carried out using this same method.

The samples used for the test are excerpts of commercially available music from three different styles; Pop (Harper 1995), Jazz (Metheny 1990) and Classical (Preisner 1999). These samples

were chosen with specific regard to their differing temporal- and frequency-domain characteristics, and not simply based on an arbitrary distinction of musical ‘genre’. There is a sufficient gap between notes to allow effects associated with the temporal characteristics of room resonances to be revealed.

The first part of the experiment identified differences in perception regarding the two metrics and the effect of varying music style. Six subjects participated in this part of the experiment. The second part of the experiment tested for differences when the original frequency content of the samples is changed, but the room models remain as previous. A total of ten subjects participated in this second experiment.

Subjects were asked to concentrate on the low frequency part of each sample, but no more specific guidance was offered as to the nature of the task.

6.6 Results and discussion

Data analysis has been performed using common statistical methods for psychoacoustics. These are powerful in providing validation and extracting important information inherent in the gathered data. The meaning of some statistical terms and an explanation of the analysis methods and their implications are given at Appendix IV.

6.6.1 Test A - Two metrics, three music styles

The results for each subject are calculated as the ratio of correct answers to the total number of trials. The mean and standard deviation of the group may then be calculated. Figure 6.9 shows the results for each of the A/B comparison cases across the three music styles. Contrast I corresponds to room 1 vs. room 2, and contrast II corresponds to room 2 vs. room 3.

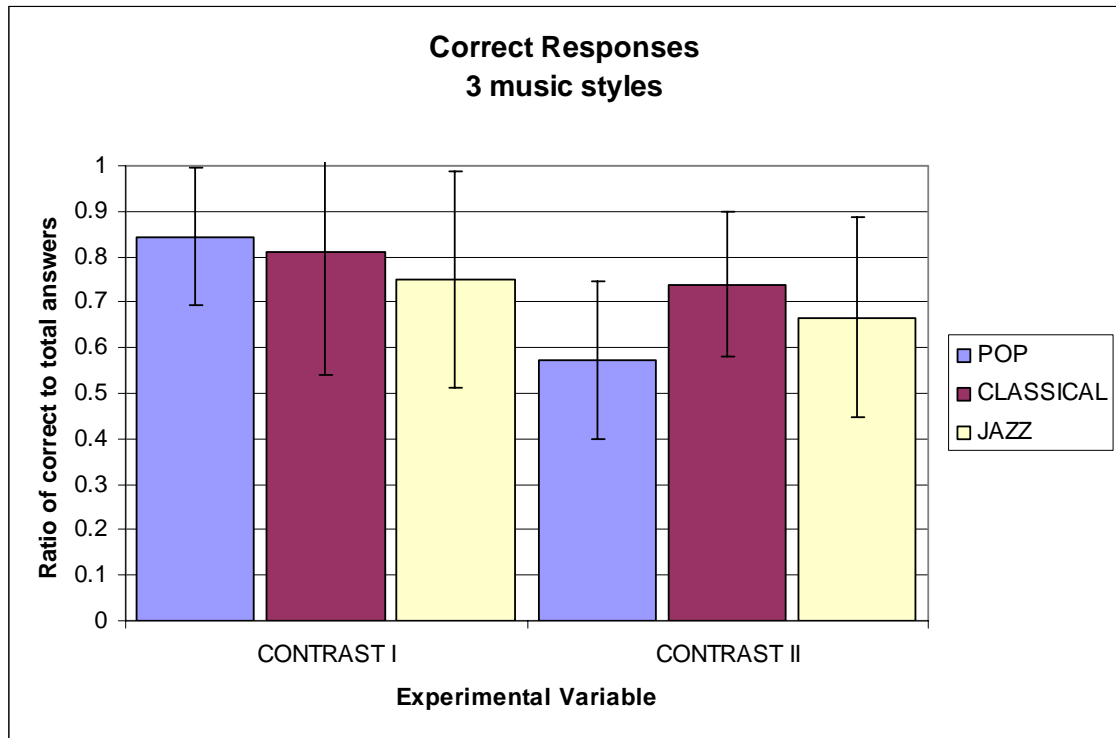

Figure 6.9 – Results for Test A. Correct answers for each music style and according to the two contrasts tested.

Contrast I results in correct room judgements more often than Contrast II regardless of program material. A chi square test was carried out to evaluate the significance of detection in each of the cases. The results are presented in Table 6.2. Under the null hypothesis (H_0) it was considered that a subject would get 8 correct responses out of a total of 16 trials.

Table 6.2 – Chi-square test results for rate of detection for each experimental case.

Metric	POP		CLASSICAL		JAZZ	
	Contrast I	Contrast II	Contrast I	Contrast II	Contrast I	Contrast II
Chi Test (p)	0.000	0.319	0.000	0.010	0.001	0.023

The results on Table 6.2 show that this group of test subjects was significantly efficient in detecting differences in all the room cases under test, except in *pop music, contrast II*. It should be noted that the statistical probability levels for contrast I are invariably lower than those for contrast II. It may thus be stated that two results for contrast II are significant ($p < 0.05$), whereas all those for contrast I are highly significant ($p < 0.01$). The difference in significance levels supports, if only weakly, that *pressure distribution* (the metric of difference in contrast I) is more closely associated with the detection of changes in the modal distribution.

A visual inspection of Figure 6.9 shows that the mean values compared across music style do not differ to a great extent within each contrast. However, the levels obtained for contrast I appear generally higher than those for contrast II. A test was carried out in order to identify the significance of effects introduced by each experimental factor – *music style* and *contrast*. Multi-

way Friedman analysis of variance (ANOVA) were used to extract this, and the results are presented in Table 6.3.

Table 6.3 – Non-parametric analysis of variance for test A on the detection of changes in modal distribution. The effects of the factors Music Style and Contrast are determined.

Experimental Factor	p
Music Style	0.34
Contrast	0.03

Friedman's ANOVA

The obtained result for music style is above the 5% level ($p=0.34$), which means that there is no significant difference in the results induced by changing the music style. Conversely, the probability that the means obtained for contrast I and contrast II are the same is very small ($<5\%$). This suggests a significant difference obtained between the *contrast* results indicating that the higher levels obtained for contrast I were induced by a larger detectable difference between the two rooms scoring extreme values on the *pressure distribution* metric.

Given that results obtained for *contrast* are significant and those obtained for *music style* are non-significant, the results may be averaged across *music style*. This is shown Figure 6.10.

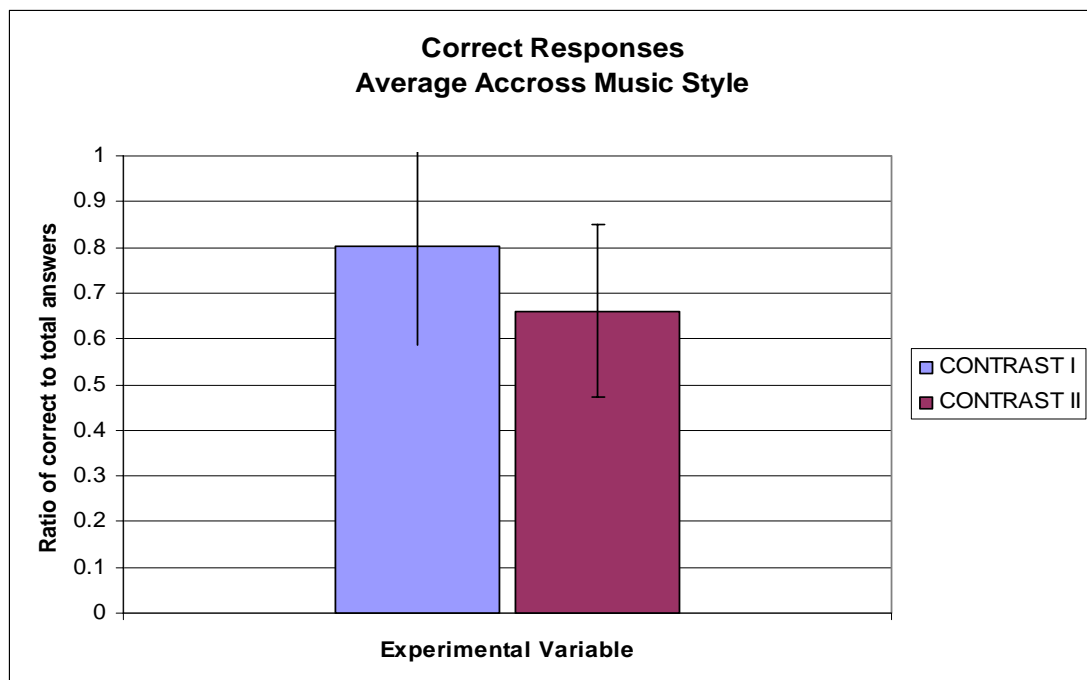

Figure 6.10 – Results for test A averaged across music style

According to the data on Figure 6.10, the level of correct responses for contrast I (0.80 ± 0.21) is higher than that for contrast II (0.66 ± 0.18). This suggests that variations in room quality according to the metric of *pressure distribution* result in higher subjective detection.

Notwithstanding, the results in Table 6.2 show that two of the three cases for contrast II are also associated with a high level of detection. Hence, subjects could also detect large changes in room quality according to the metric of *modal spacing*.

By conflation, both metrics appear suitable in describing detectable changes in room quality. However, and perhaps more intriguing, is the fact that minute variations on each scoring metric are also associated with significant detection of differences. This point is made clearer in Figure 6.3, which demonstrates that each of the contrasts between rooms correspond to aspect ratios that score extreme values in one metric but similar values on the other. Hence, if any of these metrics is to be suggested as a descriptor of the subjective quality of rooms, then under these experimental settings, support for one metric should lead to the dismissal of the other. That is not the case in the observed results.

An appropriate explanation for these findings is that the detection of differences is not solely associated with the modal distribution itself or the suggested quality rankings from the metrics under study. Furthermore, it appears that changes in the modal distribution do not affect the ability to detect effects of resonances.

Therefore, the high rate of detection in the experimental cases must be associated with a common feature. The emerging impression is that detection ability may be strongly associated with the relationship between individual signals present in the input sample and the frequency of the room modes, as might be expected. Anecdotal evidence from original pilot testing supports this idea in the following way.

During the set-up of the tests, the subjects were allowed to set the ‘start’ and ‘end’ points of the audition samples, using the test interface. When this was the case the emerging results showed that all subjects were achieving 100% correct responses and carrying out each test in a very short period. This was found to be associated with the fact that the subjects were setting the starting point for the audition of a specific note that was providing the ‘cue’ for the detection of a difference between each room condition. In practical terms, under this situation, the test becomes similar to that of single tone detection. For the main test, it was decided that subjects should not be allowed to set the start and end points of the samples, leaving temporal and frequency-domain masking effects to complicate the task in hand and reduce observation certainty, in line with that which might be experienced during the general operation of a critical listening room such as a studio control room.

Despite this deliberate interference, most subjects still reported the ‘sound of a certain note’ as the detection cue, as opposed to an overall change in the tonal quality of the samples. This explains why contrasts between room conditions that score similar values on the same metric

are still detected, since it appears that subjects rely on alterations to the sound of single notes to establish the detection of a difference.

These findings further suggest that in listening conditions, the detection of the effects of resonances is not solely dependent on the modal distribution. Testing the hypothesis that a change of musical key is more significant than changes in the modal distribution may reinforce this fact. In order to support or refute this hypothesis, a further experiment was needed. This is explained in the following section.

6.6.2 Test B - Effect of key transposition

A new experiment was devised to test for the effects of transposing the musical key of the input sample. It was decided to use a single sample given that it had been previously established that musical style has no influence on results. The Jazz sample was chosen due to its higher density of notes in frequency, therefore increasing the chances for detection of differences.

In order to test for the suggested hypothesis, a pitch-shifted version of the original sample was used. This shift was achieved with no alteration to the temporal characteristics of the sample. A percentage shift in the pitch of the original sample, transposes its musical key, and consequently originates a different set of excitation frequencies that is expected to interact with each room modal response in a different way. Figure 6.11 illustrates this, where a particularly prominent bass note is compared with a room response. The plotted 65 Hz bass note corresponds to the original sample, whereas the 75 Hz bass note corresponds to the transposed version. The test was performed using the same room contrasts as before.

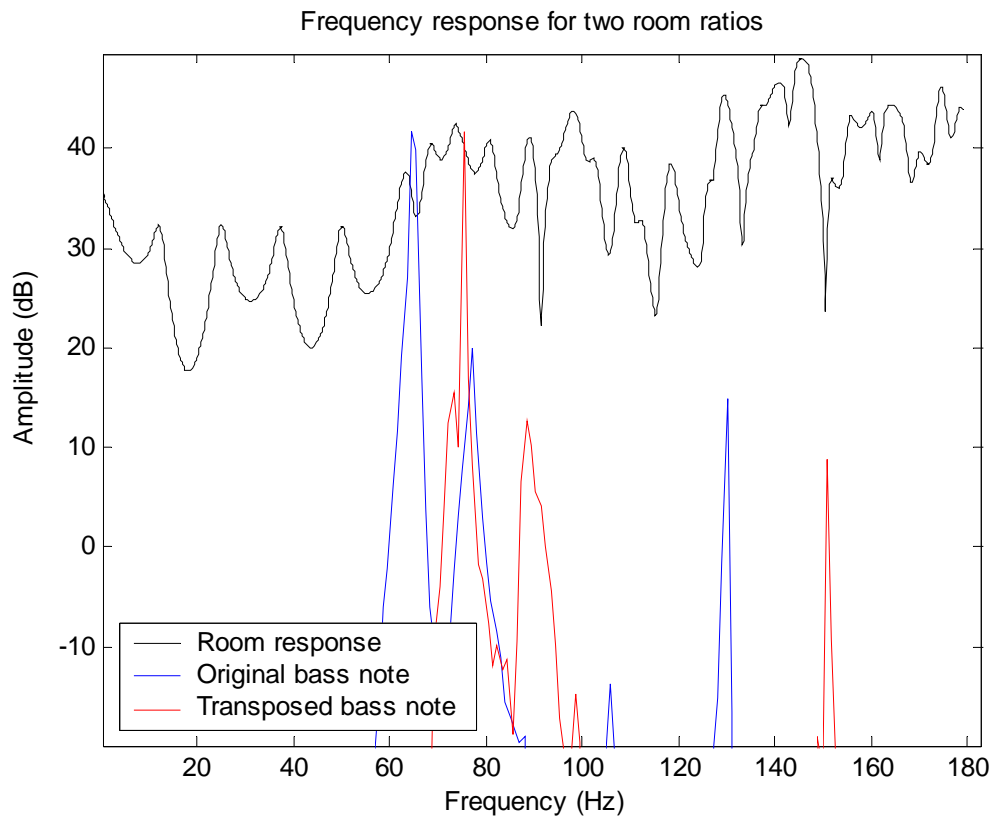

Figure 6.11 – Interaction between room response and power spectra of one note present in the input signal. A bass note is shown as original and transposed upwards in frequency

The features on Figure 6.11 show how the peaks associated with the particular bass note, its fundamental and harmonic components, align with frequency specific configurations in the room response. This match of frequencies between excitation tone and room response has been suggested to have a strong effect on perception, particularly if one tone is near the centre frequency of a resonance or anti-resonance, given that these are the cases where most alterations in the original signal are expected. The audition sample in this case will contain many different bass notes, and from observation of Figure 6.11 it is reasonable to expect that each note, when played, will match a frequency specific feature of the overall room response. The transposed version of the audition sample will have a different set of notes that align with other salient features of the response.

The systematic changes in frequency content whilst maintaining the music sample, enable the identification of trends that are otherwise difficult to infer using results between music styles. The potential analysis of results is two-fold. It may indicate the effects of transposing the key of the input sample between the same metric. This would demonstrate how much the rate of detection is likely to depend on changes made to the key of the input signal; and it may reveal the interaction effect between frequency content and each metric, given that the same room contrasts as before are used. This would thus indicate if a different ‘match’ between the frequency content of the input signal and the room response is likely to induce a significantly higher rate of detection for any of the metrics.

A new set of subjects was asked to conduct the same type of experiments on the same two contrasts. It is obvious that the normal and transposed samples cannot be compared directly for their differences in pitch. The test was run on two sets, *original* and *transposed*. Figure 6.12 shows the obtained results.

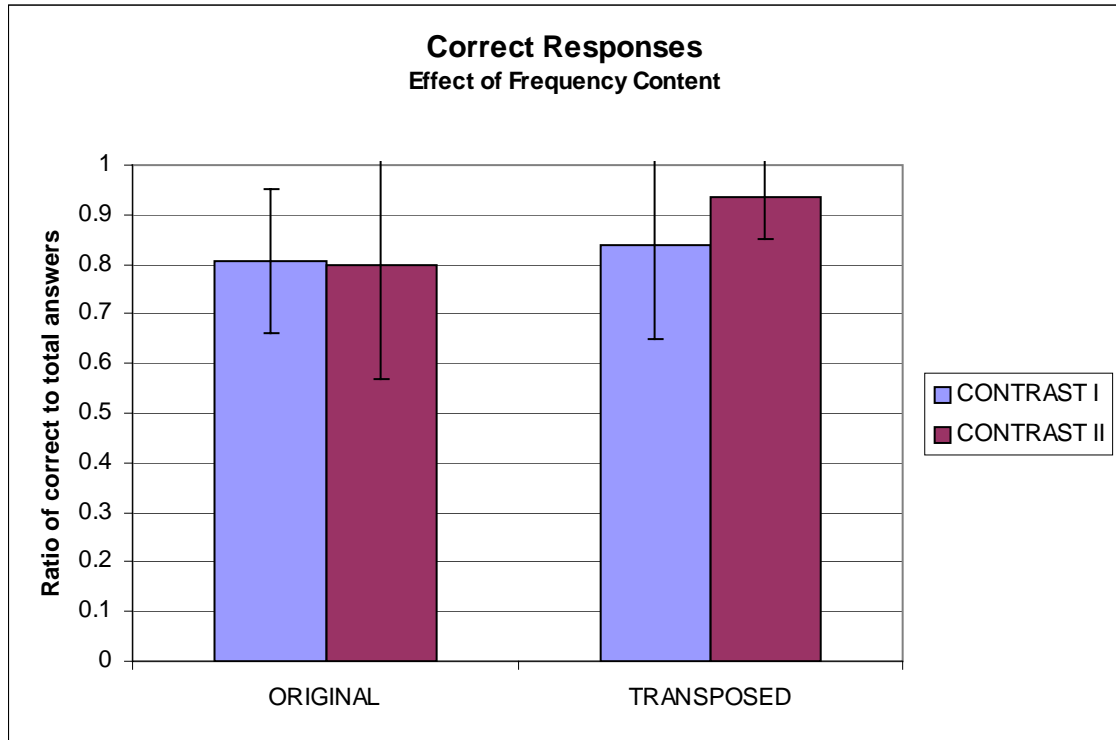

Figure 6.12 – Results for test B. Correct answers for each frequency content and according to the two contrasts tested.

The *original* case presented here is a replication of the conditions for the music style – Jazz, presented in test A. Comparison of results obtained here with those from test A show that this new group of subjects is more efficient at detecting differences for both metrics, given that the mean results obtained are higher. However, there is no difference according to *contrast* in this case, although *contrast II* has a markedly higher deviation than *contrast I*. This first result shows that for this group of subjects, none of the metrics is more closely associated with the detection of differences.

Although, the results obtained for the *transposed* case appear to be higher, the difference is not evident. Indeed, the statistical analysis suggests no significant differences between the two frequency cases, as revealed in Table 6.5. To test for significant levels of detection a Chi-square test was determined for each experimental case.

Table 6.4 – Chi-square test results for rate of detection – test B.

Chi Square Test	ORIGINAL		TRANPOSED	
Test case	Contrast I	Contrast II	Contrast I	Contrast II
Chi Square Probability (p)	0.000	0.000	0.000	0.000

In all comparisons, both for *original* and *transposed* cases, the group detected differences between all rooms at a highly significant level (all p values are below 0.001). This result is in accordance with the data observed in Figure 6.12, where the ratio of correct to total answers is well above the 50% level and the spread of data is moderate. In practice this means that subjects could reliably detect differences between the rooms contrasted regardless of the frequency content of the input sample.

Further observation of Figure 6.12 suggests that there is perhaps a difference between the mean values for each *contrast* determined in the *transposed* case. A statistical significance of these differences may be evaluated by performing a new set of analysis of variance. Table 6.5 shows the results for the Friedman ANOVA.

Table 6.5 – Test B - Analysis of variance for effects of transposition and contrast.

Experimental factor:	p
Transposition	0.11
Contrast	0.19

Friedman's ANOVA

The value for p is well above the generally accepted 5% significance level, for the *contrast* case. This means that there are no statistically significant differences obtained between contrasts.

In practice these results indicate that the subjective level of detection is neither dependent on the rank level of aspect ratios according to the metrics studied, nor affected by transposition of the original signal. These are important findings because they suggest that even if the original set of notes in a music sample is shifted in frequency, there is still high probability that audible problems will be detected.

These findings confirm that none of the room contrasts studied is individually associated with a significantly higher rate of detection of differences. Moreover, changes in aspect ratio corresponding to minute variances in score according to any of the metrics studied are still consistently detectable. Consequently, it may be concluded that none of these metrics successfully describes the perception of changes in modal distributions. As a result, it becomes difficult or even meaningless to derive difference limen based on any of these metrics.

Although subjects have reported detectable ‘cues’ for specific notes, the effect of transposing the frequency content of the input signal did not result in a consistent trend. Results show significant detection for each case, but no significant differences in detection rate between cases. With hindsight, the outcomes for test B could have been predicted, given that it had already been established in test A, that music style is not an important factor in the detection of differences between rooms with different aspect ratios. The variety of music styles tested and their inherent differences in frequency content was not a significant factor in the results.

Despite this, it would be imprecise to state that the frequency content of the stimulus is not a significant factor in the detection of resonance. Indeed, and as suggested previously, the frequency content of the input samples appears to be the decisive factor in the detection of differences. However, the mechanisms of detection are not directly associated with frequency distributions, but rather with temporal behaviour. This is further explained by the following.

Most music is comprised of series of musical tones, each having a limited duration, and specific spectra with fundamental and harmonic components. Throughout the length of a music sample, each tone has a possibility of interaction with a particular room mode, or with many if the harmonic components of the tone are accounted for. Therefore, the probability for a single tone to match the frequency of a room mode is high, and every time such a match occurs, there is a chance of resonant problems that translate into detection cues, regardless of the aspect ratio chosen. This alerts for the fact that a room that scores highly on a certain metric may still suffer from problems, every time the notes on the input signal match a problematic frequency region of the room response. It follows that the meaning of describing the quality of a room according to metrics relying on modal distribution is seriously undermined by the potential problems caused by myriad tones present in any musical stimulus.

Moreover, any system that ‘creates’ resonances that fill in the gaps between neighbouring room modes, as suggested in section 5.3.2 or in previous literature (e.g. Bonello 1981; Angus 1999 b), will only be effective if the number of modes introduced is very large, therefore increasing the modal density to similar levels as those obtained above the Schroeder frequency. If only a small increase in modal density is achieved, the original problem escalates given that there will be more resonances in the sound field that may interact with individual tones of the stimulus and cause perceptible problems. The applicability of such techniques is also dependent on the Q-factor of the modes, and as such, the damping characteristics of the added resonances should be designed to combine with the existing room modes in order to achieve a less variant frequency response and provide a homogeneous decay of sound at a wide frequency range, as is characteristic in high frequency diffuse fields.

6.7 Summary

Experimental tests were set-up to evaluate the validity of two commonly used metrics that describe the ‘quality’ of a room according to its modal distribution. The aim was to investigate the subjective importance of modal distribution and to define a difference limen for the metric most closely related to the perception of changes in room aspect ratios. The difference limen could then be used as a guide for design recommendations and as a control target for optimisation techniques that are found in literature.

In the first experiment, each of the metrics was studied using three different music styles. Results indicate that there is no direct effect of the music style on the rate of detection of differences between rooms with different aspect ratios. Additionally, it was found that both metrics studied induce a high rate of detection, with higher result for the metric based on pressure distribution.

In a second experiment, the effect of transposing the key of the input stimulus on the detection of differences was tested. As before, the results showed that all cases tested were associated with significantly high levels of detection, but this time, no significant trend was identified for any of the metrics.

Therefore, it was concluded that the ranking of room ratios and the derivation of a continuous list describing the room quality based on the studied metrics is likely to be misleading, and hence, a meaningful difference limen, which might be expected to apply for ‘all music’, is difficult to establish.

These findings suggest that the perception of modal resonances is more closely associated with the interaction of single notes with specific frequency regions of the room response. This implies that the detection of resonances in rooms is closely bound to the musical character of the original signal and how individual notes interact with room modes. This forms the subject of investigation in the following chapter, where the effects of resonances on single tones are investigated.

7 Effects of Resonances on Single Tones

7.1 Introduction

In order to fully understand the subjective effects of resonances in rooms it is useful to look at quantifiable effects in the time and frequency domain responses of signals. It has been shown in Chapter 6 and in previous investigations (Fryer 1975; Bucklein 1981; Toole et al. 1988; Olive et al. 1997), that the temporal characteristics of the excitation signals play an important role in the detection of room resonances. Additionally, results have revealed that the relationship between the frequency of individual stimuli and the frequency of the modes is perceptually more important than the modal distribution in the room or the frequency distribution of notes in the input stimulus.

This chapter addresses these issues raised in Chapter 6, where it is suggested that the cues enabling detection between rooms with different modal distributions originate in the interaction between individual notes in the input stimulus and the room response. Indeed, this is also mentioned by Bucklein (1981), who found that the effects of resonances are only noticeable when the stimulus frequency is at or near the resonant frequency.

The focus of the present chapter is on the response of a simple resonant system to a single frequency stimulus. The frequency of the stimulus is selected to match a specific point in frequency of the resonant system. A distinction is made between resonance, off-resonance and anti-resonance excitation. This investigation aims to provide further understanding on the effects of amplitude, frequency and time on the perception of single tones in the presence of resonances.

The input stimuli used in the experiments presented here are based on single tones, and this is a departure from the previous experimental method, where music signals were used to closely represent the conditions in critical listening rooms. The use of test tones is chosen in this chapter to facilitate the demonstration of the underlying mechanisms of interaction between stimuli and resonant systems. Indeed, the inspiration for the use of simple tones arises from the waveform representation of common low frequency sounds present in the previously used samples, such as a bass drum or guitar, and the performers action when playing – struck skins and plucked or bowed strings. Obviously, the effects that overtones (higher harmonics) may have on the overall response are not accounted for, given that only the room resonances near the frequency of the input stimuli are under study.

Section 7.3 presents a discussion of objective factors resulting from the interaction between single tones and resonances. This discussion is made possible by the use of models of resonance

that allow control over factors such as amplitude, Q-factor and frequency of resonances. The models used for this study are based on bi-quad infinite impulse response (IIR) filters. These are described in detail in 7.2.

Subjective tests are then performed on the audibility of different cases commonly found in room responses, as opposed to previous studies based on the effects of individual resonances (Fryer 1975; Bucklein 1981; Toole et al. 1988; Olive et al. 1997). The experiments concentrate on the effects of the temporal content of the stimulus regardless of the amplitude level of the resonances. Tests are carried out at a normalised amplitude level in order to identify effects that are solely associated with time or frequency characteristics of the systems under study. A short study is also presented on the effects of altering the Q-factor of resonances and how this affects the detection of differences between the stimuli and the system output. The tests are carried using a similar method to that employed in Chapter 6. However, in this case, there is no requirement to create a high frequency component of the binaural response given that the test uses single tone excitation.

Section 7.5 presents the results and discussion of the subjective tests. The results identify important characteristics of resonant systems, which are found to induce audible effects and are directly associated with the problems introduced by room modes in listening spaces.

7.2 Low frequency resonances

Chapter 3 presents the derivation of a modal decomposition model to describe the sound field in a lightly damped rectangular enclosure. A further approximation to this model may be obtained in digital form from the use of biquad infinite impulse response (IIR) filter models (Morjopoulos 1991; Darlington et al. 1996). This provides a response that may be readily used to filter a given input signal in order to obtain an output according to test requirements. Because this digital approximation of the modal decomposition model is still based on the principle of orthogonality, it is arguable that it should not be employed to model conditions where high damping is involved. The main section of this chapter uses Q-factor values of 20, and therefore the assumptions of low damping are not violated. However, in section 7.5.3 and in Chapter 8, the Q-factor of the resonators may assume very low values, in which case the underlying assumption of modal orthogonality is not met and model predictions may deviate from the precise conditions found in real sound fields. The implications of this will be revisited and discussed further in section 8.2.1.

A resonance representing a single mode may be generated by a z-plane IIR filter in a bi-quad arrangement. In this case, the response obtained is that of a band pass filter, where the centre

frequency and bandwidth are dependent on pole angle and pole radius respectively. Important factors of these filters such as bandwidth, gain and centre frequency are easily controlled.

A system comprised of two resonances may be obtained from the addition of two bi-quads. Residual interaction between the two resonances is controlled by the phase of each filter, and the output gain of the filter section may be scaled by a multiplication factor in the difference equation.

The difference equation is used to derive the filter coefficients that describe its response. Equation 7.1 shows the difference equation for a bi-quad IIR filter.

Single resonance –

$$y(k) = 2R_p \cos \theta y(k-1) + R_p^2 y(k-2) + Kx(k) - Kx(k-2)$$

Equation 7.1

where R_p is the pole radius, θ is the pole angle and K is the output scaling factor. The filter coefficients can then be determined accordingly. A system comprised of two or more resonances may be obtained by adding the output of two such filters.

Figures 7.1, 7.3 and 7.5 show a practical example of the response for a generic filter representing a resonant system with one resonance centred at 80 Hz, and a Q-factor of 20. This was obtained by modelling a bi-quad filter using coefficients determined by the difference Equation 7.1.

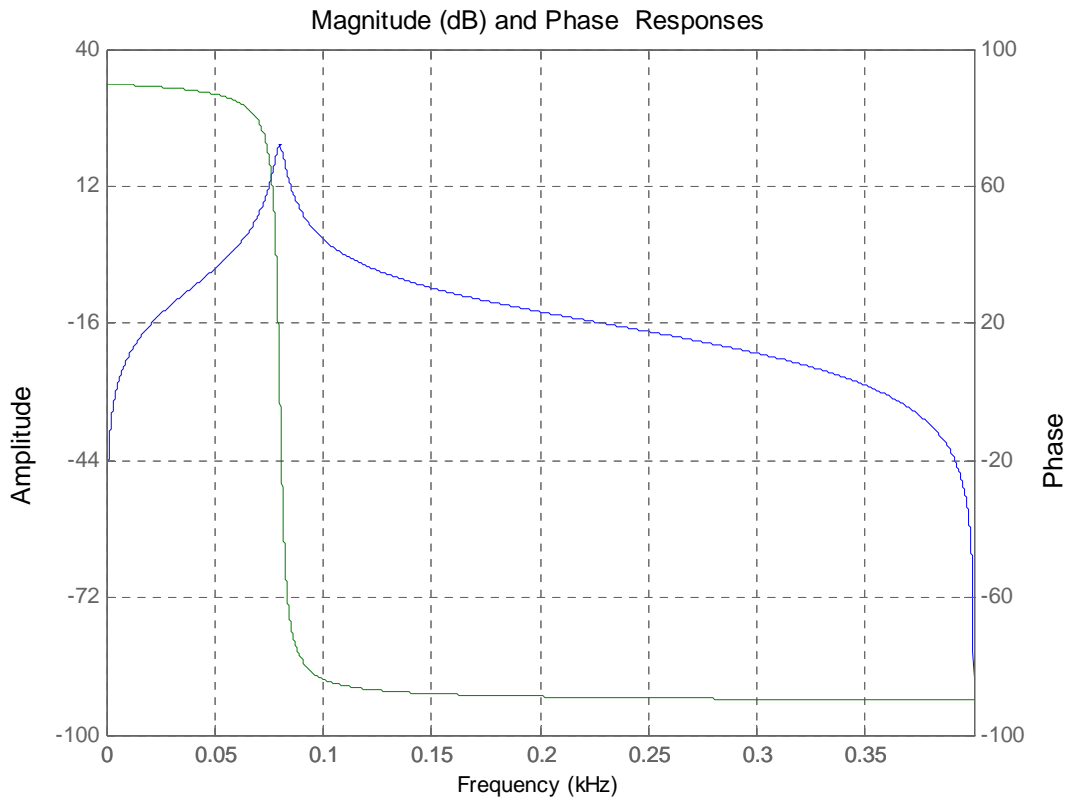

Figure 7.1 – Magnitude and phase response for a resonant system with centre frequency 80 Hz and Q-factor of 20. Modelled using a single bi-quad pole/zero configuration.

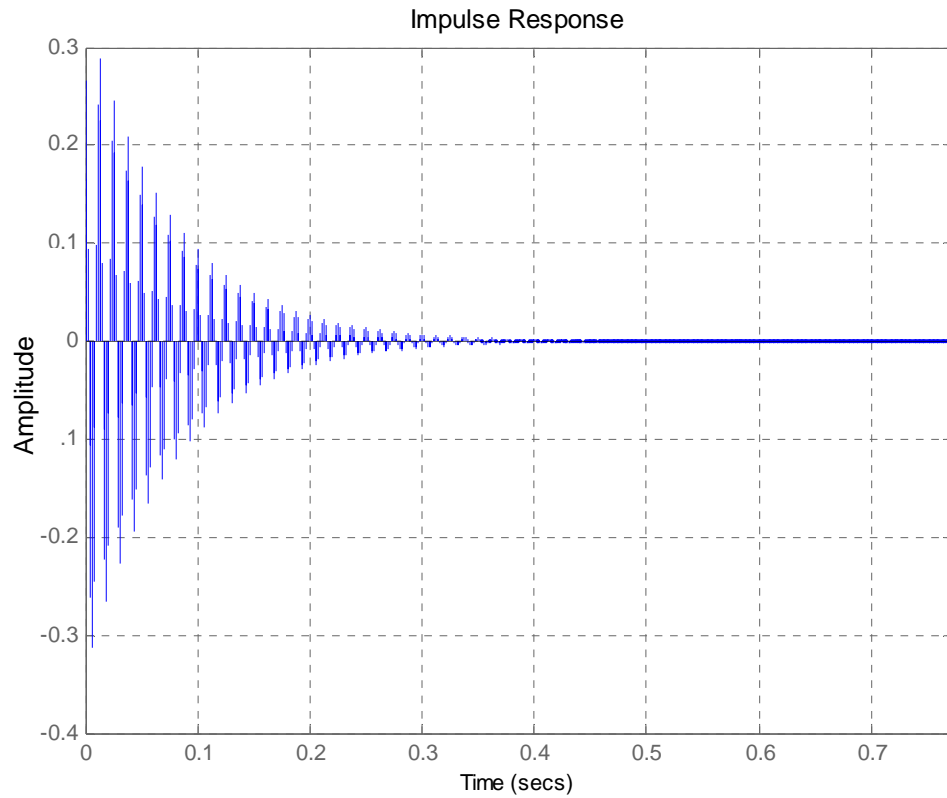

Figure 7.2 – Impulse response of resonant system with one single resonance of 80 Hz and Q-factor 20.

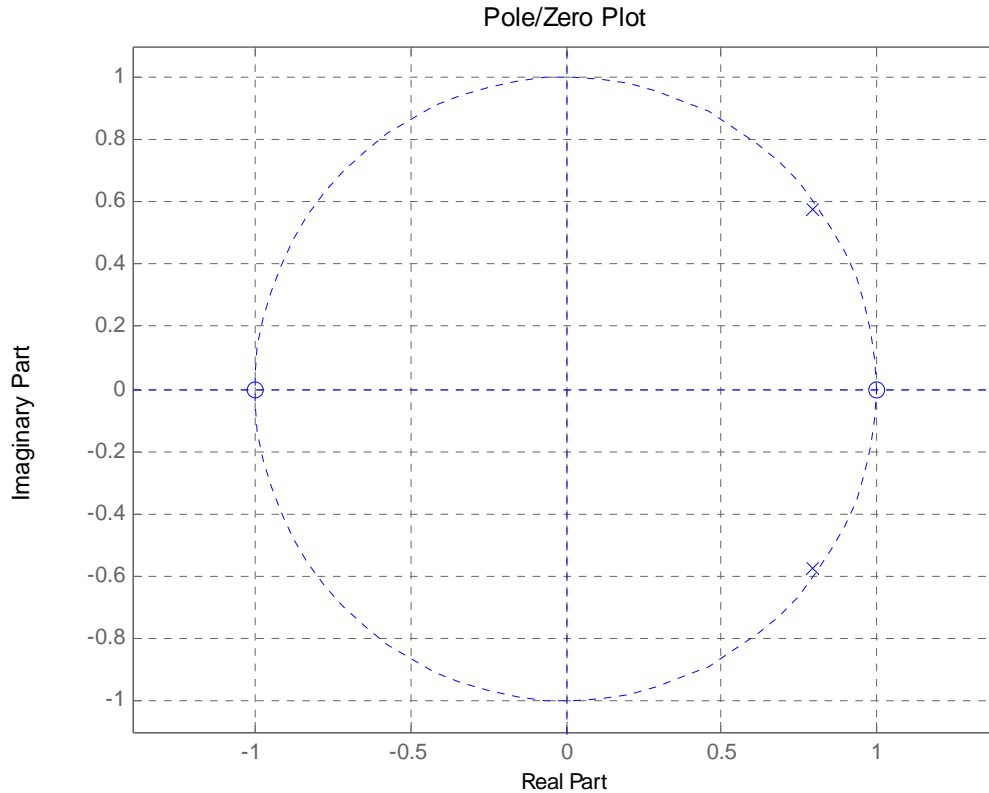

Figure 7.3 – Pole/Zero plot for a bi-quad IIR filter with centre frequency 80 Hz and Q-factor of 20. Sampling frequency is 800 Hz.

Observation of the above figures shows important detail regarding the behaviour of resonances. Figure 7.1 shows a peak in the magnitude response centred at 80 Hz and a phase shift at resonance, as expected. The bandwidth of this resonance is defined by the distance from the pole to the unit circle depicted in Figure 7.3. The two zeros are placed at 0 and π values of frequency in the unit circle ensuring no gain at these frequencies. Observation of Figure 7.2 shows that there is an associated exponential decay time for this resonance, which is dependent on its Q-factor. For room resonances the T_{MODAL} decay time may be determined by an approximate equation (B&K 1994; Howard et al. 1998):

$$T_{\text{MODAL}} = \frac{2.2Q}{f_0}$$

Equation 7.2

where Q corresponds to the quality factor of the resonance and f_0 is the frequency of resonance. In this case $T_{\text{MODAL}}=0.55$ seconds. The practical example shown in Figure 7.2 confirms this result. The responses for the three resonant systems under study in this chapter are shown in Figure 7.4.

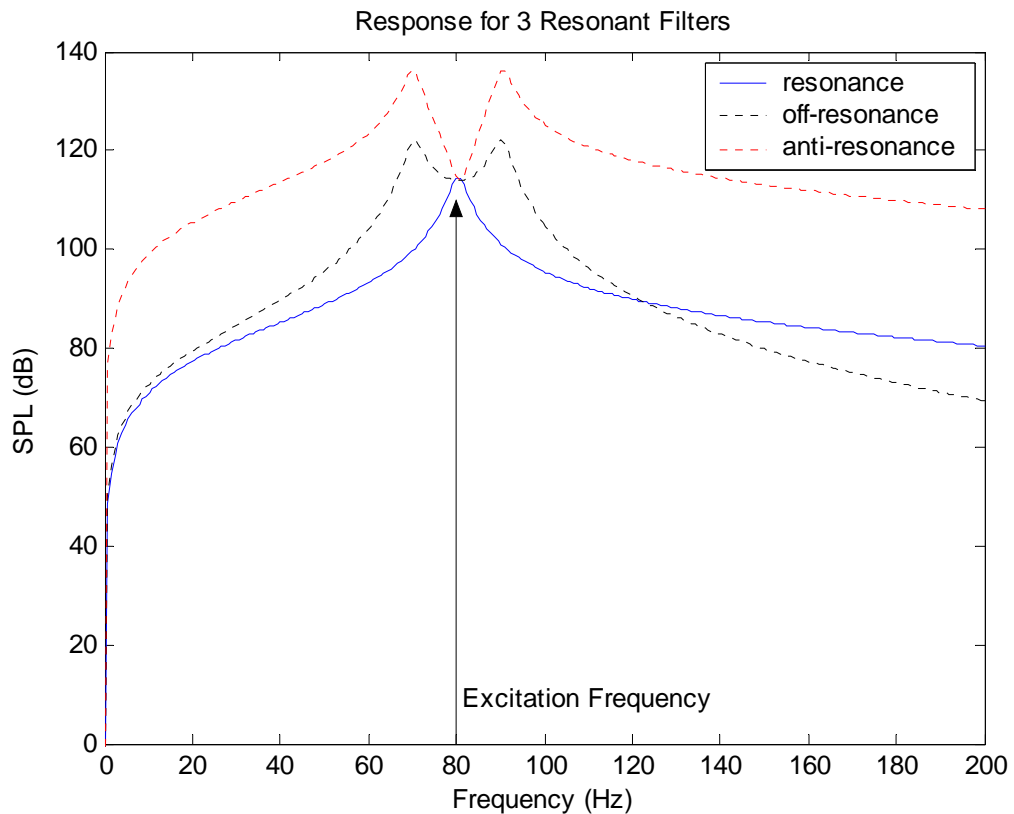

Figure 7.4 – Three resonant conditions commonly found in rooms at the frequency of excitation.

These are three situations commonly found in rooms if the range near the frequency of the input stimulus is considered. The gain for each system has been adjusted so that the amplitude at the driving frequency, indicated by a black arrow in Figure 7.4, is the same. The resonant frequencies are 80 Hz for the single resonance and 70 Hz and 90 Hz for the dual resonances. The anti-resonance is obtained by inverting the phase of one of the filters. It is important to note that the anti-resonance is generated by the combination of two resonances as is the case in a modal decomposition model of a room transfer function and not from a notch filter as is the case in other experimental methods (Bucklein 1981; Olive et al. 1997).

7.3 Temporal aspects of input stimuli

To facilitate the understanding of the stimuli-room interaction mechanism, it is necessary to define the input signal. Test signals are commonly used and chosen according to their definable properties. Knowledge of these properties allows an objective analysis of the system, given that the frequencies and amplitudes at the input are known. Test signals usually consist of either single frequency tones or wide band noise. The temporal behaviour of the signal is also an important property, as it influences the bandwidth of the signal and has repercussions on the response of resonant systems.

A common test signal is known as a tone burst (Salava 1991). This is composed of few cycles of a single frequency tone. The amplitude envelope of this signal may be shaped to produce the input or ‘source velocity’ of the system to be studied (e.g. Figure 7.5). The single frequency properties are somewhat detached from real sounds, but allow a more informed understanding of the stimulus-system interaction mechanisms that would not be possible with more complex signals. With appropriate amplitude envelope definition, this type of stimulus may be compared to the sound of a bowed instrument such as a cello, with a constant output while the player bows the string. Depending on the performer’s action, the attack⁷ and decay⁸ portions of the signal are altered accordingly.

In this chapter, the effect of the temporal behaviour of the stimuli will be studied. In general, two cases will be investigated. These will be designated according to the length of time that the stimulus has high output amplitude. *Long stimulus* describes a signal with smooth varying envelope whilst *short stimulus* describes a transient signal created by an exponentially decaying sine wave. Figure 7.5 shows the source velocity of one of the input stimulus under study here.

⁷ ‘Attack’ generally refers to the time taken for a signal to reach its maximum amplitude level at the onset. Fast attack time instruments are plucked or struck like plucked strings or drums. Bowed instruments can sound smoother, therefore with a slower attack.

⁸ ‘Decay’ describes the time taken for a signal to decrease from its loudest level to inaudibility at its offset. Vibrating strings with large initial amplitude may produce long decays.

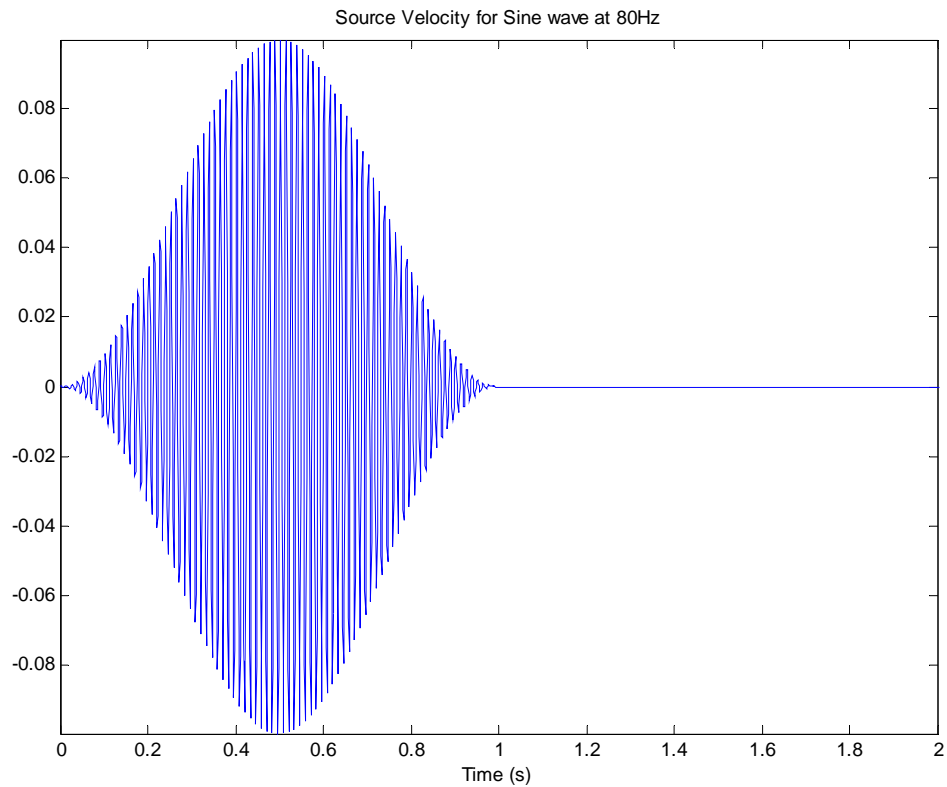

Figure 7.5 – System input signal modelled as various cycles of a single tone of frequency 80 Hz and with a smooth amplitude envelope. The amplitude envelope is a Tukey window with a tapered to non-tapered ratio of 1.

This signal is plotted as a 1 second long sine wave at 80 Hz, with 1 second of silence afterwards. The tone burst is shaped by a *Tukey* window to reduce spectral leakage. The tapered to non-tapered sections of the window shape are controlled by a ratio. The ratio in this case is 1, which means that the signal approaches maximum amplitude at the middle of its duty cycle. The effect of the window is to create a slow rise on the onset and a slow decay on the offset sections. In effect, this process is known to remove the wideband energy existent in fast transients of signals. It may be shown that when the windowing ratio is reduced the onset and offset rates are faster, generating more energy in the side bands - outside the frequency of the input signal. The signal output is on long enough for any steady state effects of the resonances to develop. The power spectra for this stimulus may be obtained from its Fourier transform and is shown in Figure 7.6.

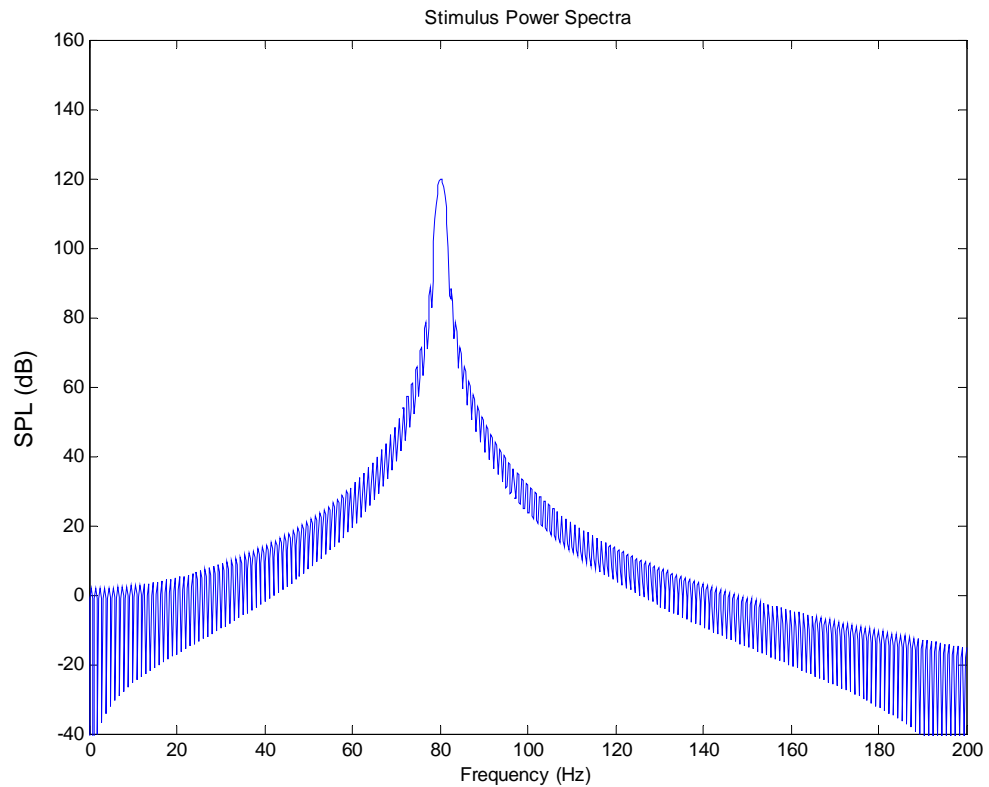

Figure 7.6 – Power spectra for a smoothly varying sine burst centred at 80 Hz. Response obtained by Fourier transforming the time domain input.

It is clear that most of the energy of the signal is concentrated at the 80 Hz frequency, with reduced levels of energy at the remaining frequency range. The side band ripples apparent in the power spectra are caused by the windowing process and would appear in a simple Fourier transform if applied only to the windowing envelope.

7.3.1 System response to long stimulus

Figure 7.7 represents the waveform at the output of the single *resonance* system depicted in Figure 7.4. The input to the system is the *long stimulus* shown in Figure 7.5.

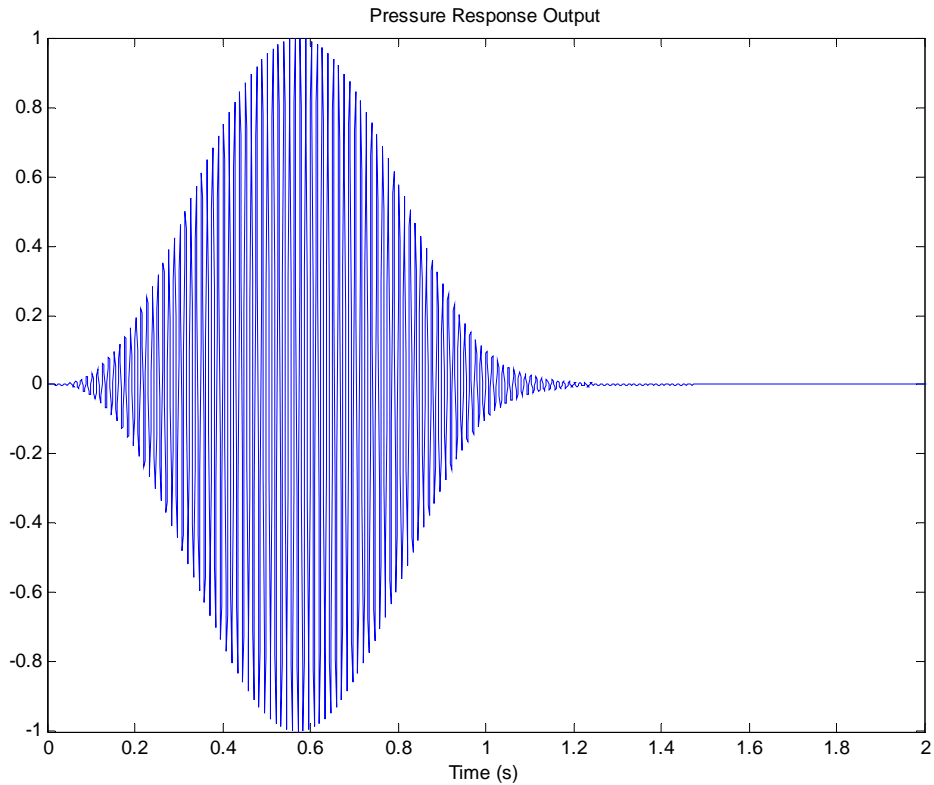

Figure 7.7 – Output response of a single resonance at 80 Hz when subjected to a smoothly varying 80 Hz sine burst.

Comparing Figure 7.5 (input) and Figure 7.7 (output), there are no apparent distortions caused by the filter behaviour. However, more careful analysis shows that the output is somewhat longer, extending beyond 1 second, which is the original length of the input stimulus. This long decay is associated with the resonant properties of the filter, and directly related to its Q-factor, as indicated by Equation 7.2. This effect is sometimes described as ‘ringing’, and for very high Q resonances ($Q > 30$) it may be clearly audible, albeit at the same frequency as the input signal – because input and resonant frequencies match. It is also noticeable a longer rise time at the onset of the output – the output waveform reaches maximum at around 0.58 seconds. This indicates an onset delay until the system reaches full resonance.

The output power spectrum is shown in Figure 7.8. It can be seen that there is no introduction of other frequency components, as the stimulus and the resonance have the same centre frequency. A comparison with Figure 7.6 shows no major differences apart from an expected gain of 20 dB introduced by the resonance.

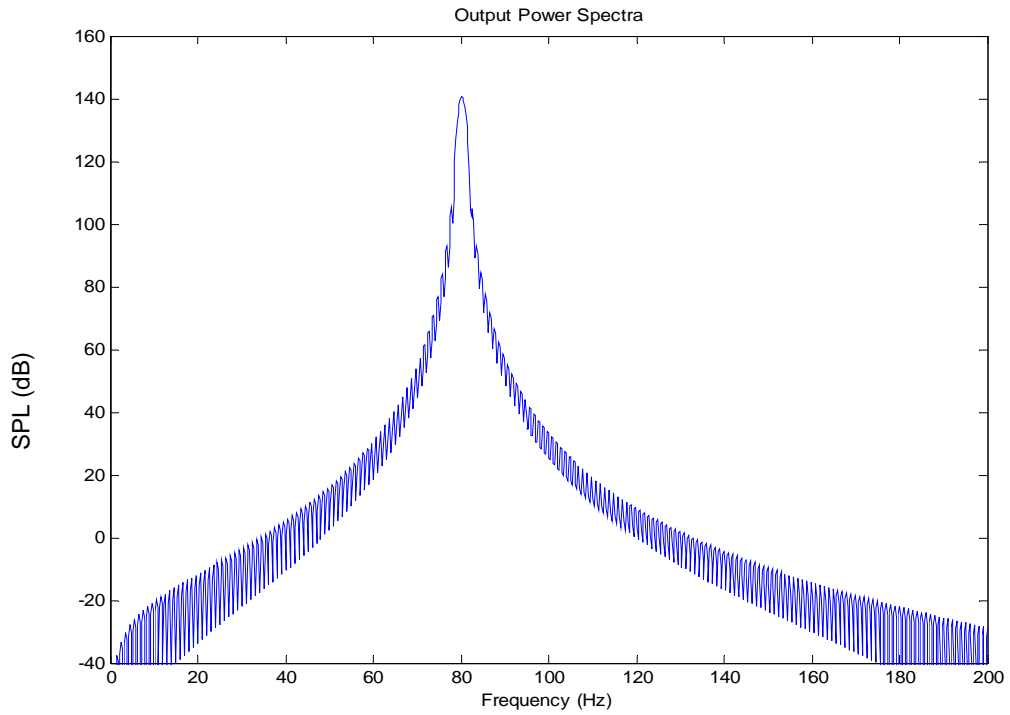

Figure 7.8 – Output power spectra for a single 80 Hz resonance when subjected to a smoothly varying 80 Hz sine burst.

The same filtering process is now carried out for the *off-resonance* shown in Figure 7.4. The same input is used, which in this case falls between the two resonances. The output of this resonant system is shown in Figure 7.9.

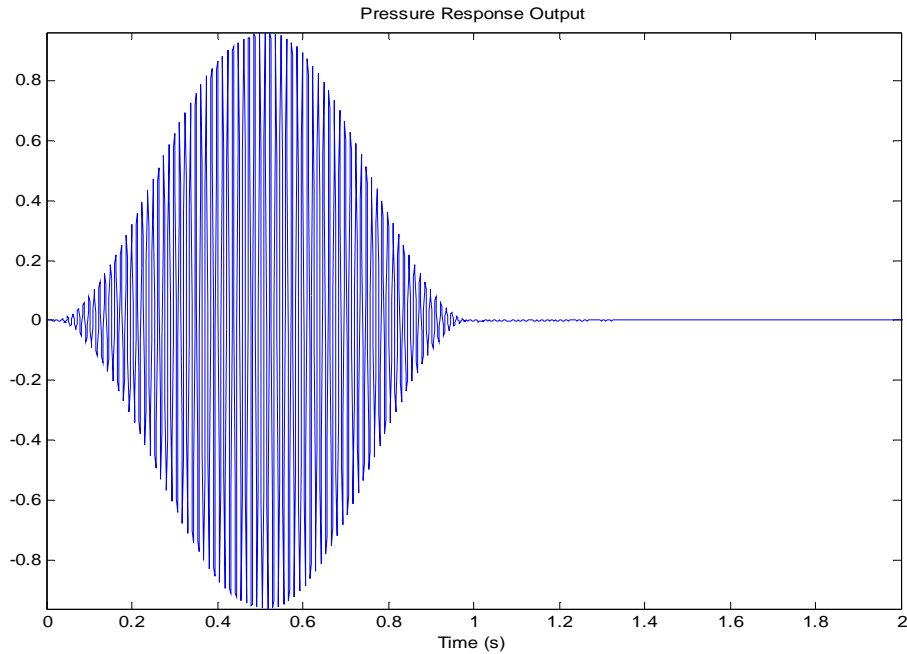

Figure 7.9 - Output response of resonant system comprised of two components at 70 Hz and 90 Hz when subjected to a smoothly varying 80 Hz sine burst.

Observation of Figure 7.9 shows that the initial waveform has not been distorted considerably. There is evidence of a long decay at small amplitude, after one second. This is introduced by the combination of the resonant components and has characteristics that are dependent on their frequencies. This effect will be discussed further in section 7.3.2.

The spectral response for this system is shown in Figure 7.10. The introduction of the two resonant spectral components is revealed as an increase in the bandwidth of the output between 60 Hz and 100 Hz. It should be noted however, that these changes are introduced at a considerably low level when compared to the peak value of the overall response – i.e. 60 dB below.

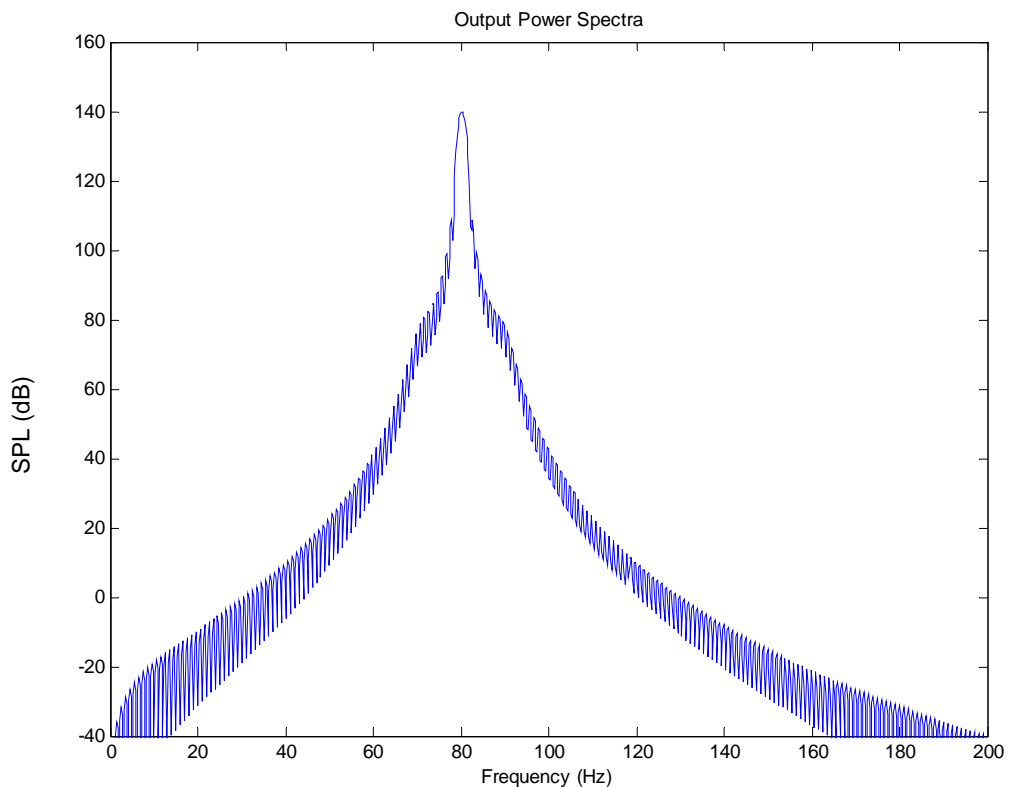

Figure 7.10 - Output power spectra for two resonances at 70 Hz and 90 Hz when subjected to a smoothly varying 80 Hz sine burst.

An interesting display of the data on figures 7.14 and 7.16 may be obtained by combining the time and frequency responses in a single plot. This type of display is commonly described as a *power spectral decay* (PSD) or *waterfall* plot. A power spectral decay shows the progress of the spectral components in time. This is determined by Fourier transforming short consecutive windows of the time waveform, and plotting these successively in a time axis. The size of the Fourier transform window determines the low frequency resolution, and the step size between each window determines the time resolution. Follows a description of the parameters used here to obtain the PSD:

Sampling frequency $f_s = 800$ Hz

Length of original signal = 4 seconds

Portion of signal containing non zero values = 1 second

PSD Window length = 0.4 seconds

PSD step size between windows = 1.3 milliseconds

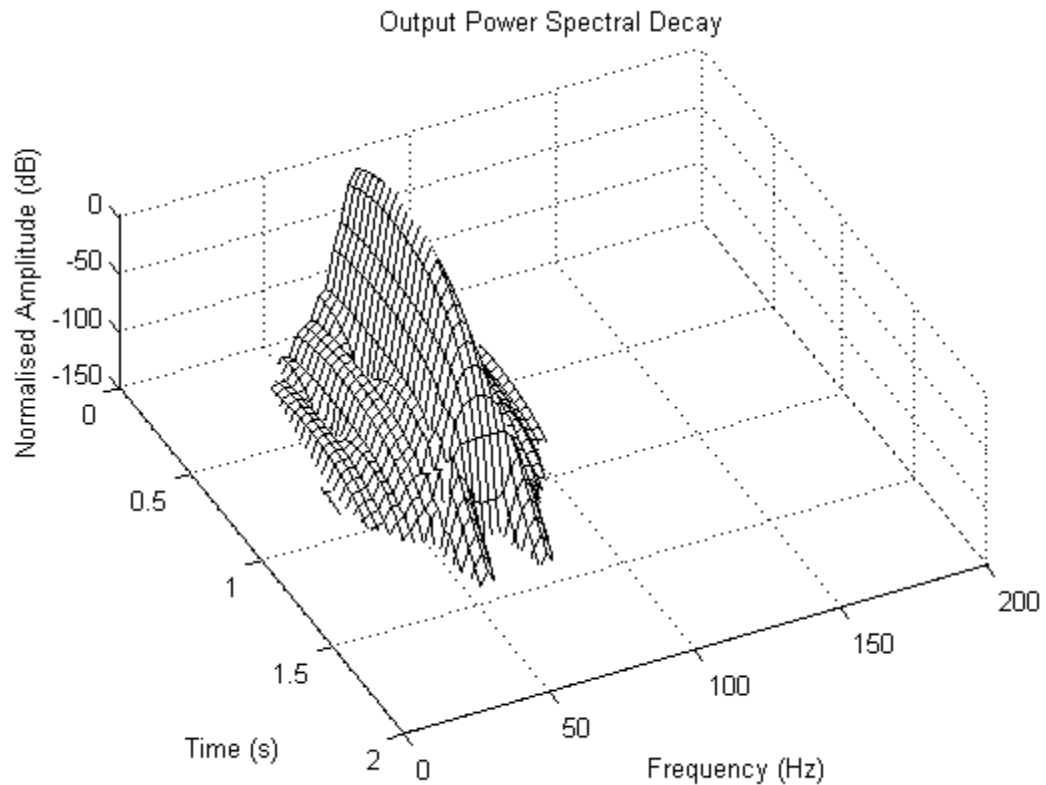

Figure 7.11 – Output power spectral decay for a dual resonant system with long input at 80 Hz. The forced response is dominated by the input stimulus, whilst the natural response shows evidence of the two resonant components.

Figure 7.11 shows the strong 80 Hz component of the stimulus, which lasts for approximately 1 second. When the stimulus is removed, there is a transfer of spectral energy to the frequencies of the two resonances. This effect is visible, although the initial amplitude of the resonances appears at a considerably low level. The audibility of this condition is investigated in section 7.4.

A third case is investigated, described as *anti-resonance* in Figure 7.4. The time domain response of this system to the same stimulus is shown in Figure 7.12.

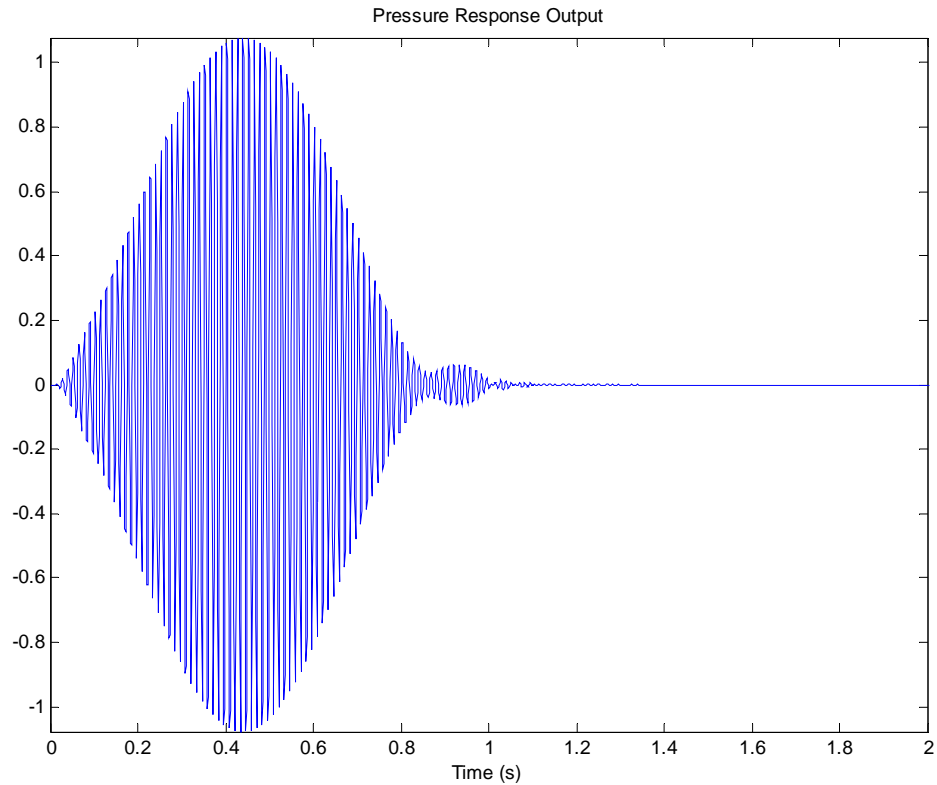

Figure 7.12 - Output response of an anti-resonance at 80 Hz when subjected to a smoothly varying 80 Hz sine burst.

The output response shows a faster onset as the waveform reaches maximum amplitude and also a faster decay when the wave first approaches its minimum value. This shows that room anti-resonances have an opposite effect to that of resonances, which have been shown to delay the onset and offset of the signals. An obvious effect is also evident at the end of the waveform where a small amplitude modulation caused by the interaction between the two resonant components causes a clear distortion of the input waveform. This amplitude fluctuation is caused by the interaction between the resonant frequencies of the system. If the frequency of the input signal and the resonant modes is different, a shift in the frequency of the sound will occur at its natural decay region. Its audibility will depend on the amplitude of the interaction.

The effects on the frequency domain are shown in Figure 7.13. Evidence of the two resonant components at 70 Hz and 90 Hz are clearer in this case compared with the resonance case. The level of the spectral components is about 50 dB below the maximum level of the output.

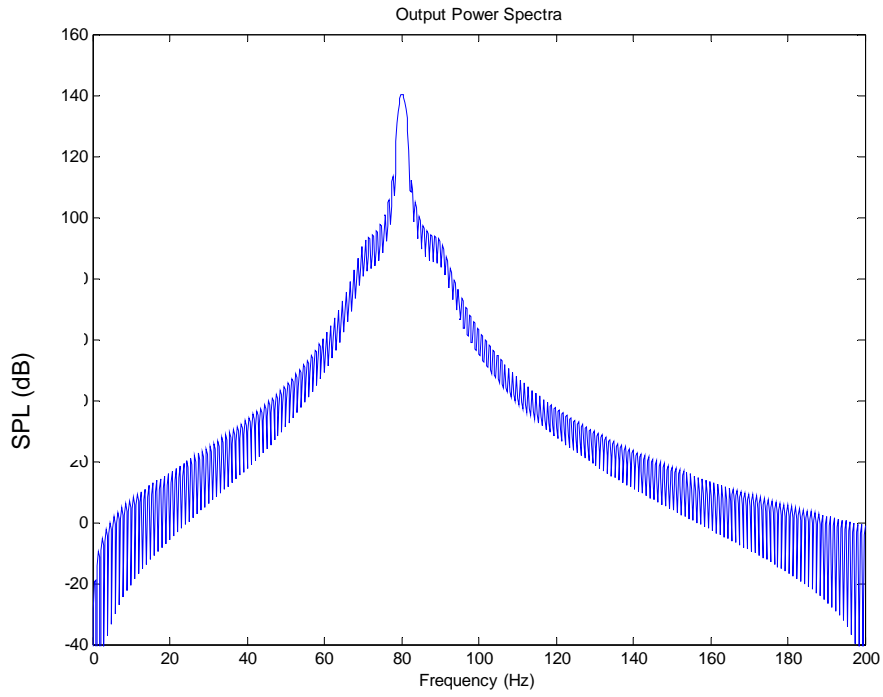

Figure 7.13 - Output power spectra for an anti-resonance at 80 Hz when subjected to a smoothly varying 80 Hz sine burst.

The PSD is shown in Figure 7.14.

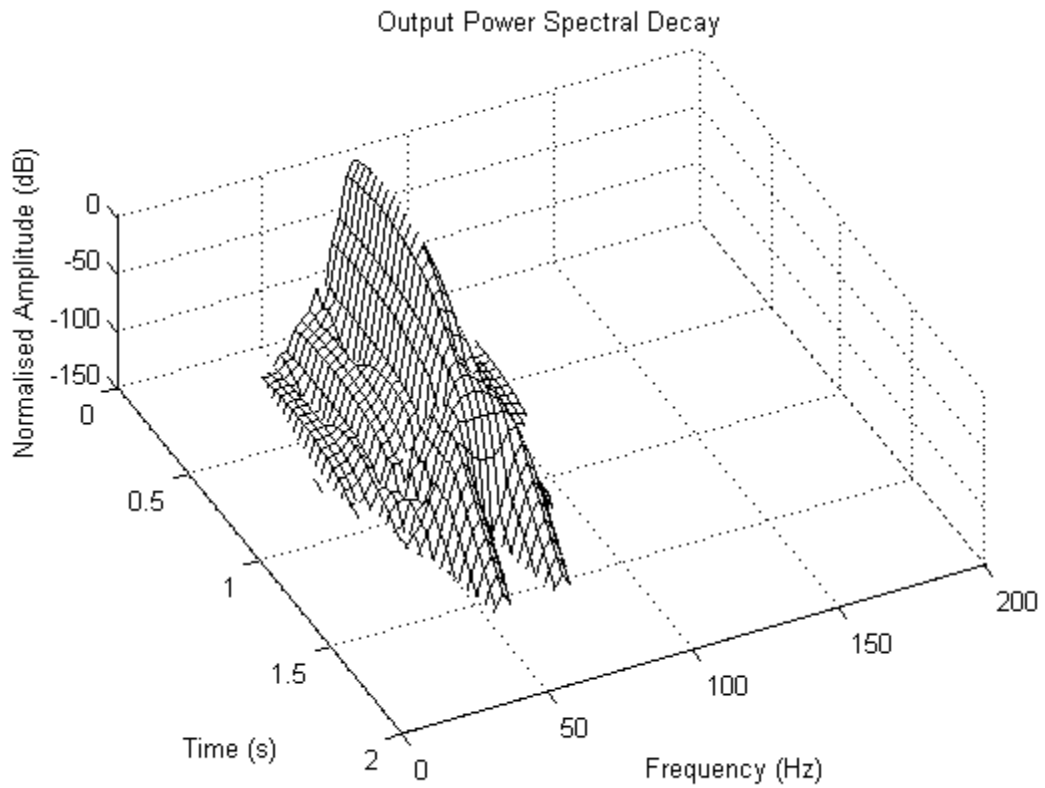

Figure 7.14 - Output power spectral decay for an anti-resonant system with long input at 80 Hz. The forced response is dominated by the input stimulus, whilst the natural response shows evidence of the two resonant components.

As seen for the previous (resonance) case, the PSD shows a response mainly dominated by the input stimulus until it is removed, after which the energy in the system is transferred to the resonant components, which have low initial amplitude.

7.3.2 System response to transient stimulus

Hitherto, the input stimulus to the system has taken the form of a single frequency tone that has been shaped by a window to obtain a smooth amplitude envelope. This windowing process has been shown to reduce much of the energy outside the centre frequency of the signal because it removes the fast amplitude variations.

A different type of stimulus considered here consists of an exponentially decaying sine wave centred at the same frequency as before. This type of transient stimulus may be assumed as generally representative of a ‘plucked’ bass guitar string, with a fast attack and a relatively short decay. Figure 7.15 shows the time behaviour of such a stimulus.

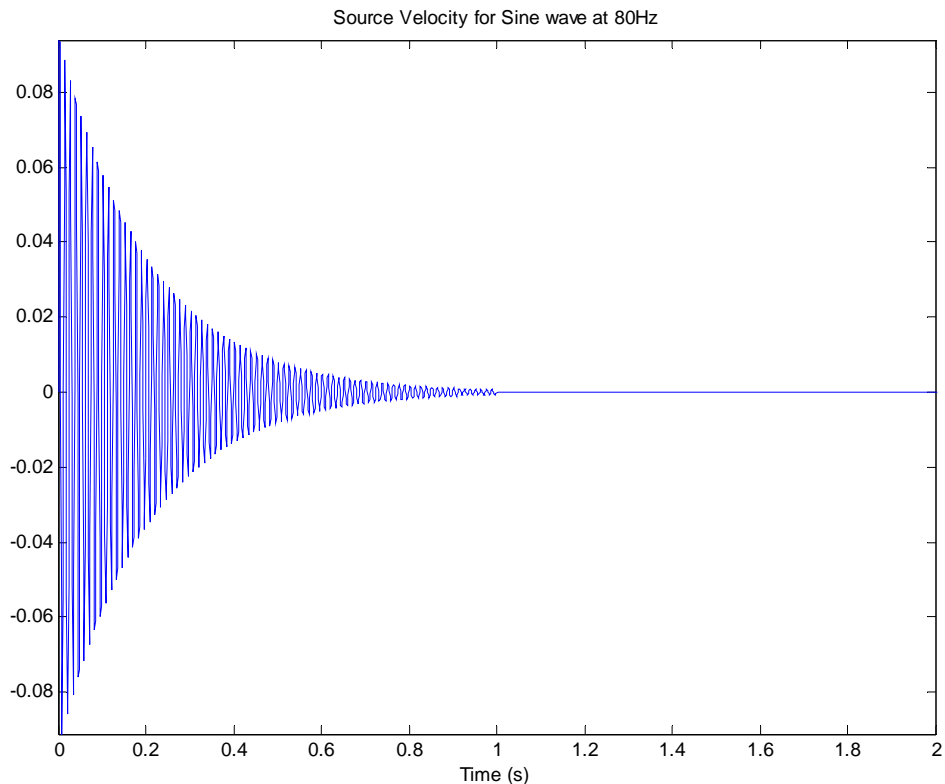

Figure 7.15 – Time representation of a single frequency transient tone (80 Hz) with fast onset. This waveform is representative of a ‘plucked’ string instrument such as a bass guitar.

It is clear that the waveform has a very fast attack and a relatively fast decay. The effects of this temporal behaviour are reflected in the power spectra shown in Figure 7.16.

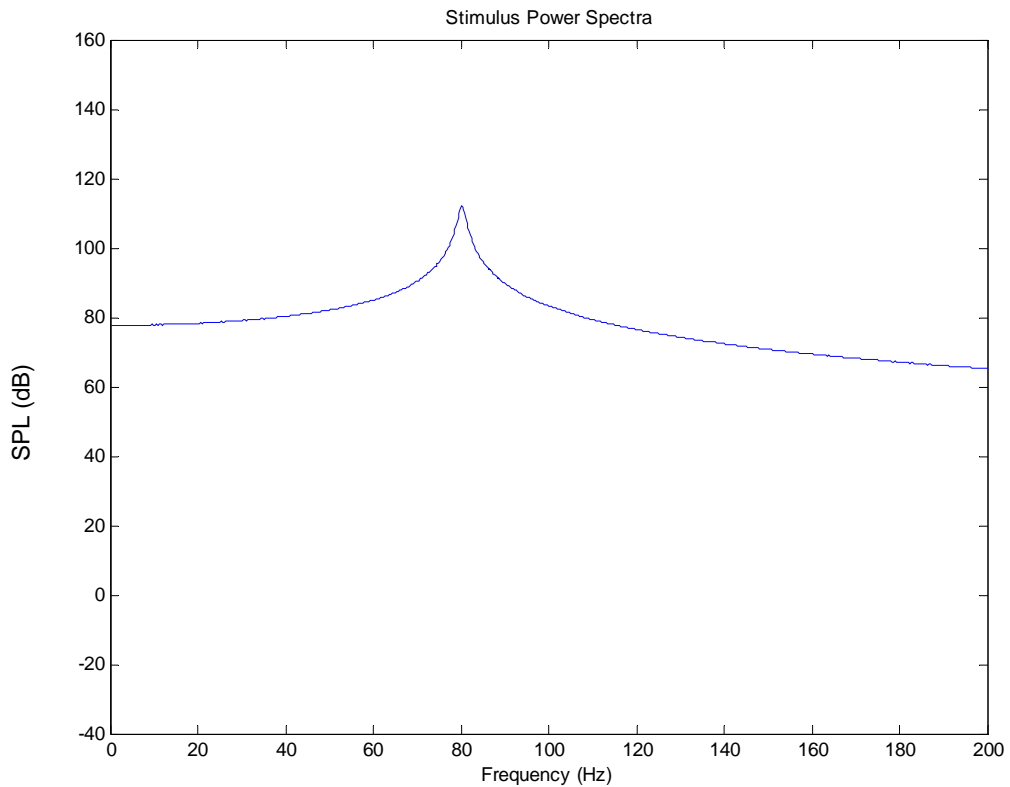

Figure 7.16 – Power spectra for transient input signal. The wideband levels are evident. This increase in wideband energy is associated with the transient behaviour of the signal.

This signal has a clear frequency component at 80 Hz, but it is obvious that higher levels of spectral energy are present at the remaining frequency range (c.f. Figure 7.6). This is associated with the fast attack at the onset of the wave.

The same three cases depicted in Figure 7.4 and corresponding to different resonance conditions are studied following the same order. Figure 7.17 shows the time response output of the *resonance* system.

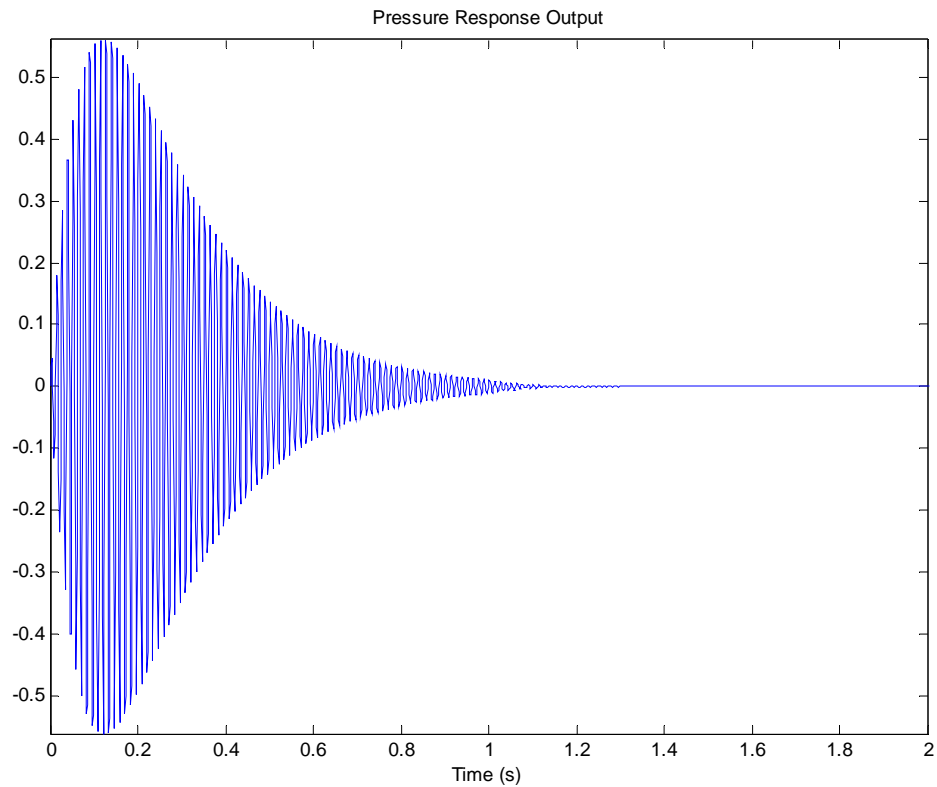

Figure 7.17 – Pressure response output of a single resonant system with matching stimulus and resonant frequencies (80 Hz). Stimulus is modelled as a transient tone.

The effects of the high Q resonance, with a correspondingly long onset time, are noticeable in the fact that the system does not respond instantaneously to the sharp attack of the stimulus. It is also interesting to note that, due to the same mechanisms, the decay of the output clearly extends beyond the original stimulus duration of 1 second. The output spectra is shown in Figure 7.18. The features at the system output show that there are no other components in frequency, added to the original input. This would certainly be expected in a linear system.

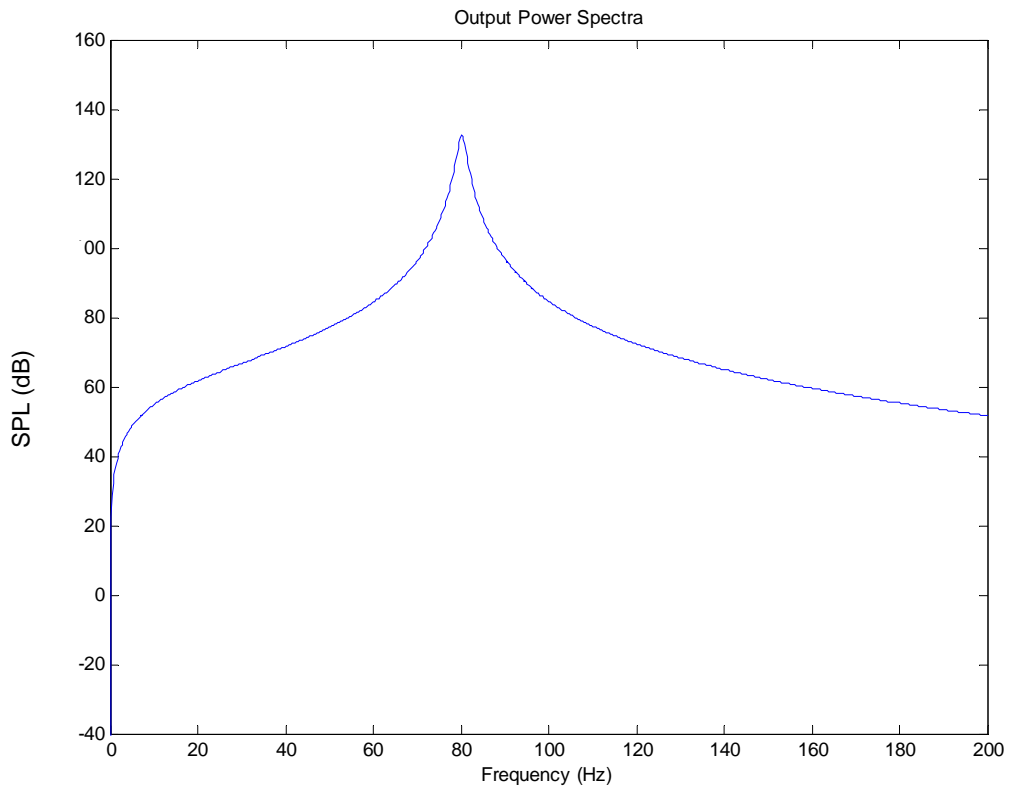

Figure 7.18 – Output power spectra for a single resonant system with matching stimulus and resonant frequencies (80 Hz). There is no evidence of the introduction of extra spectral components.

The second case studied is depicted as an *off-resonance* in Figure 7.4. This instance, the stimulus (80 Hz) falls on a smooth region between the two resonances (70 Hz and 90 Hz). The output response shown in Figure 7.19 clearly shows some interesting effects in the time domain. The resonant behaviour has altered the fast transient present in the input stimulus, appearing as a rise in the onset time of the output. Perhaps, more intriguing is the amplitude fluctuation clearly marked by the peaks and troughs of the response. It is interesting to note that this fluctuation has a period of 0.1 second, which corresponds to a frequency situated half way between the frequencies of the two resonances in the system. This topic is discussed further in section 7.3.3. Finally, and due to the resonant behaviour of the system, the response is extended in time, albeit for a very short period and at an extremely low amplitude.

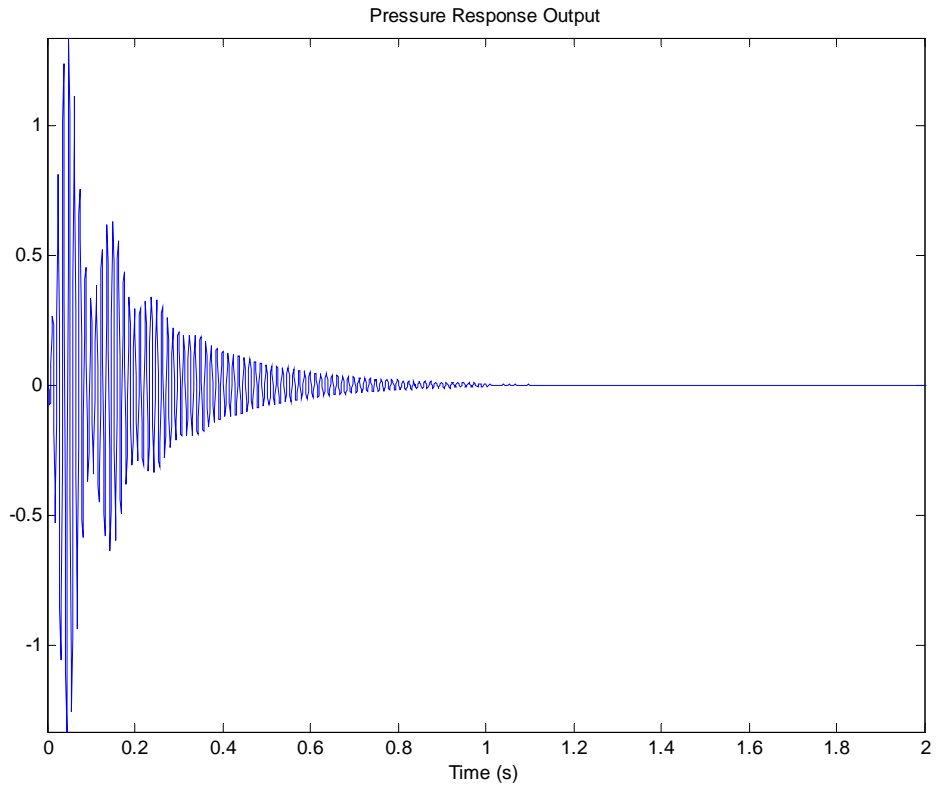

Figure 7.19 – Output pressure response for a dual resonant system with a transient stimulus. The response shows a slower onset time and amplitude fluctuations due to the interaction between the spectral components of the system. There is evidence of a decay longer than the original input stimulus.

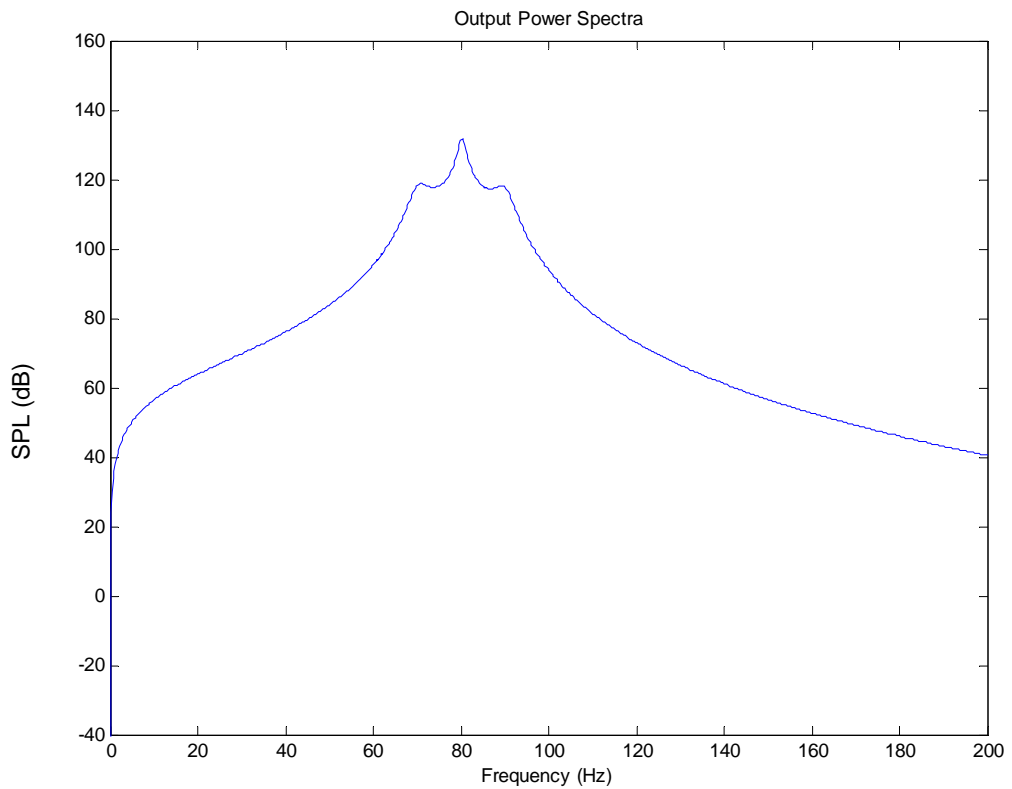

Figure 7.20 – Output power spectra for a dual resonant system with a transient single frequency input. The two resonances appear as spectral content approximately 15 dB below the input spectral component.

The spectral response of the output is shown in Figure 7.20, and reveals components at the stimulus and resonant frequencies, which in this case are at a higher level than that obtained for a similar system but subjected to a narrow band input stimulus as presented in section 7.3.1. Because the ‘generation’ of extra frequency components in a linear system is not possible, the strong excitation of frequencies other than at the input has to originate in the broadband energy inherent in the transient character of the stimulus. Observation of the PSD in Figure 7.21 shows interesting features.

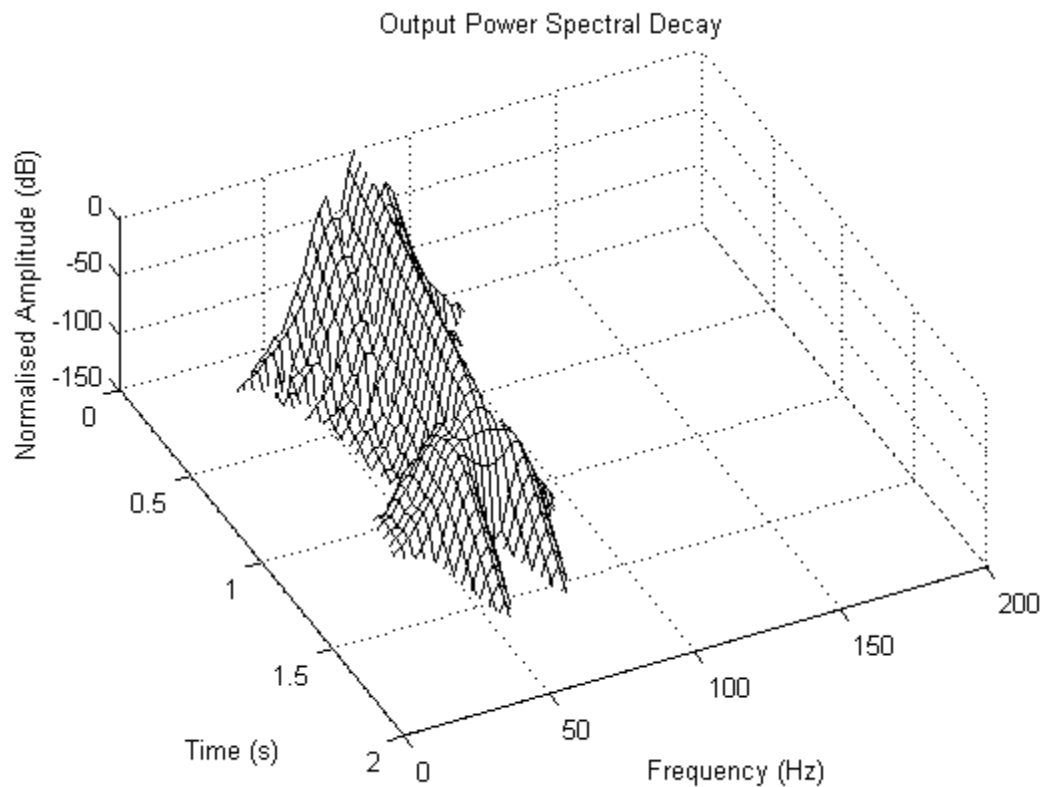

Figure 7.21 – Output spectral decay for a dual resonant system with a transient single tone input. There is evidence of the two resonant spectral components at the onset and natural responses of the system.

The spectral decay plot in Figure 7.21 shows evidence of three components in frequency – the stimulus and the two resonant frequencies. At the onset of the output signal, the resonant components decay at a much faster rate than the stimulus. When the stimulus is removed, the resonant components reappear and decay at their natural rates. It is interesting to compare figures 7.21 and 7.14, representing the response of the same system to the different input stimuli. The initial amplitude of the decaying resonances is shown to be much larger for the case presented here

The last case under study corresponds to the *anti-resonance*. The output of this system when excited by a transient stimulus is shown in Figure 7.22.

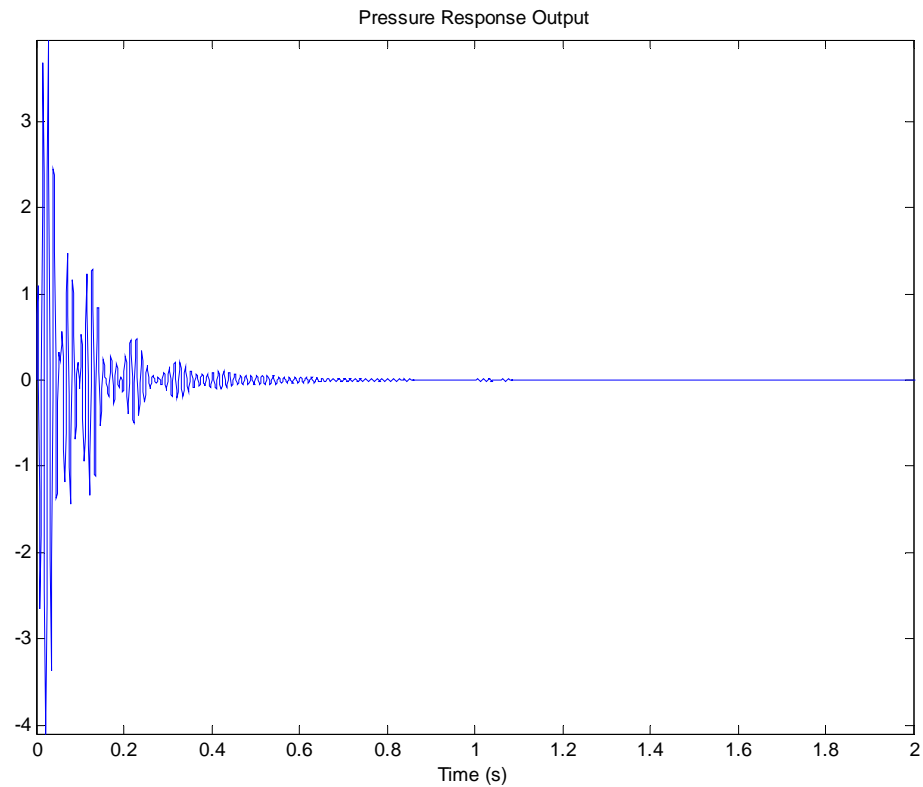

Figure 7.22 – Output pressure response for an anti-resonance with a transient single tone input. The response shows a fast onset time and amplitude fluctuations caused by the interaction between the spectral components of the system.

The output response of this system has a much faster attack time than its equivalent *resonance* or *off-resonance* responses. This is an interesting fact to note, given that this is the only case where the attack time of the note has not been severely delayed. As in the resonance case, there is evidence of amplitude modulation (AM) being introduced by interaction of the spectral components of the system. The AM on the first part of the sample is determined by the three spectral components of the system. When the stimulus is removed, the remaining decay is dominated by the effects of the two resonant components. This effect is shown by the change in period of the amplitude modulation. In opposition to what was observed for the previous two systems, there is no strong evidence of a prolongation of the output. However, an effect appearing after 1 second suggests that the amplitude modulation may effectively extend for a long time and at low amplitude after the stimulus has been removed. The spectral output of this system may be shown in the following power spectrum.

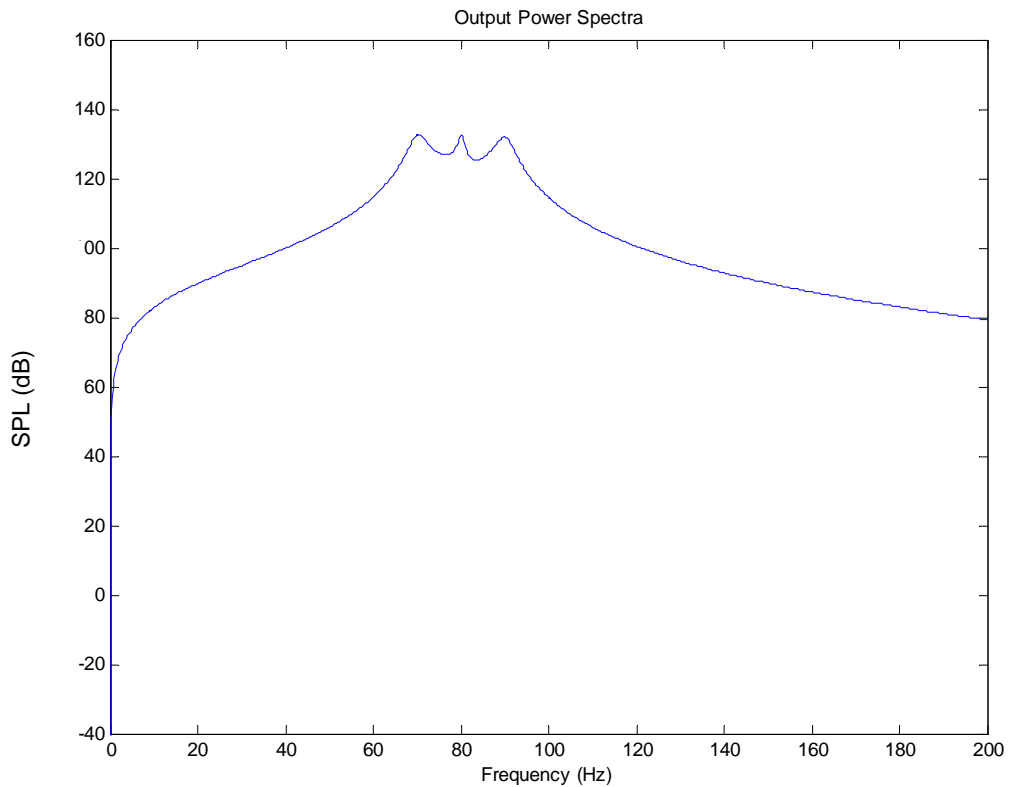

Figure 7.23 - Output power spectra for an anti-resonance with a transient stimulus. The two resonances that form the anti-resonance appear as high-level spectral content on each side of the input stimulus.

Contrasting figures 7.23 and 7.20, the spectral component of the stimulus is at a much lower amplitude relative to the resonances. This is expected given that by definition an anti-resonance at a specific frequency effectively reduces its amplitude relative to other frequencies – c.f. Figure 7.4. The PSD in Figure 7.24 shows these effects clearly.

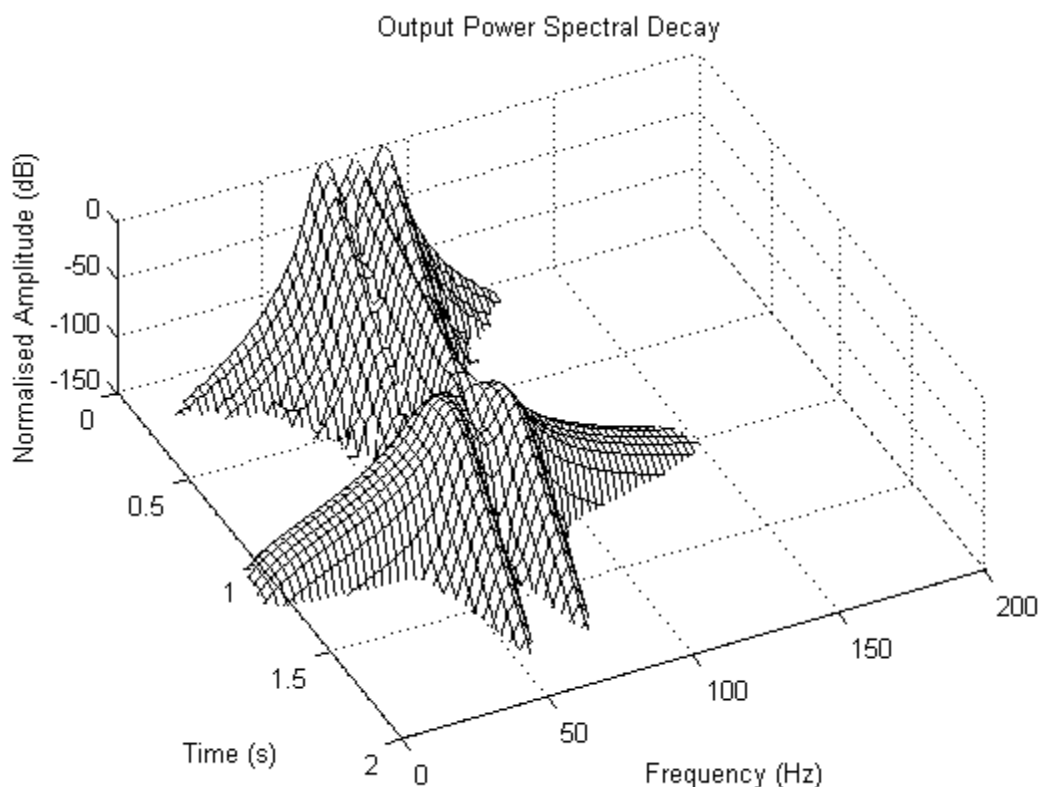

Figure 7.24 - Output spectral decay for an anti-resonant system with a transient single tone input. There is evidence of the two high level resonant spectral components at the onset and natural responses of the system.

Figure 7.24 clearly reveals that the spectral component of the stimulus start at a much lower amplitude relative to the resonant spectral components, when compared to the previous *off-resonance* case. The decay rate of the system resonances is faster than that of the stimulus, which implies that for a short period of the output, only the stimulus is present. When the stimulus is removed, the two resonant components reappear at a considerable level. This transfer of energy is expected given that in their free response, the energy stored in the resonances decays at their own rates. Beranek (1968, pp294) refers to an analogy between such resonant systems and 'an electrical parallel-resonance circuit in which energy has been stored initially'. If there are two or more resonances decaying simultaneously, there will be evidence of beats⁹ due to the different frequencies of each resonance. Contrasting with the *off-resonance* case, the resonant components reappear at a much higher level relative to the amplitude of the input. This large energy transfer to the resonant frequencies is again explained by the higher wideband energy present in transient signals. It is this off stimulus energy originated in the transient character of the stimulus that excites the system resonances so effectively.

⁹ Beats occur when two simple tones of similar but different frequencies (<5Hz) are added together. The result is a simple tone with average frequency between the two original tones and amplitude modulated with frequency equal to half their difference.

7.3.3 Discussion for the temporal effects of input stimulus

It has been shown that the effect of resonances is very much dependent on the alignment between the input frequency of the stimulus and the resonances. The discussion presented here concentrates on quantifiable effects on the time and frequency responses of the system independently of the well known effects that any system may impose on the overall output amplitude.

It has been shown in the modelled examples, that the temporal envelope of the stimulus is an extremely important factor when considering the interaction with resonant systems. It is clear that when the stimulus has a transient character, the effects of resonances are exposed. Under the assumption of a linear system, the introduction of extra frequency components not present at the input is not possible. Therefore, these spectral components have to be excited by energy present in the stimulus. It has been demonstrated that the spectrum of a transient tone consists not only of a single frequency but also of wide band spectral energy related to its temporal characteristics. This may be observed from the Fourier transform of its envelope, where transients originate a spread of energy in the frequency domain. The delta function and its associated constant magnitude in the frequency domain is an extreme example of this. This corroborates the effects demonstrated in section 7.3.2, where the fast transient stimulus exposes much clearer effects than a smoother version of a single tone with slow attack and decay.

The mechanisms underlying the excitation of resonances by single tone stimulus may be explained by the following. During the excitation phase, energy is stored in the system at the resonant frequencies. In the room case, and if the input signal is on long enough, standing waves are set-up. At the onset, and dependent on the amount of spectral 'spread' from the input, there is a possibility for amplitude modulation caused by interaction between the input and the resonant spectral components. This is clearly evident in figures 7.19 and 7.21. When the excitation signal is removed, the energy stored in the resonances decays at their natural rate. If the offset of the stimulus is also associated with wide band spectral 'spread' (e.g. an abrupt ending such as stopping the string of a bass guitar), more energy excites the resonances, which start their decay cycle at a higher amplitude. Once more, if there are two or more resonant components close in frequency, an amplitude modulation effect is revealed. These effects are evident in Figure 7.24.

The effects of resonant 'configuration' of the system are summarised here. Special attention is given to effects caused in the presence of a transient input signal, given that its perception is more likely to be dramatically altered by resonances.

A single resonance at the same frequency as the stimulus introduces changes in the waveform, slowing the response of the system to transients. This is associated with the high Q-factor of

resonances, and indicates that the amelioration of the problem may have to involve a reduction of this parameter if the transient character of input signals is to be preserved. Indeed, most of the distortions introduced are related to time domain response, as there is clearly no introduction of other frequency components in this case.

If the driving frequency lies between two resonances, then more than one mode will be excited. The extent to which these modes are excited depends on their bandwidth and the energy present outside the main stimulus frequency. In this case, the effects appear mainly at the onset and offset regions of the output signal. As in the resonance case, fast transients present in the stimulus are distorted. Another main feature revealed, is the amplitude fluctuation introduced by the interacting resonant components close in frequency. This effect mirrors the well-known psychoacoustics phenomenon of first-order beats (Moore 2003).

In some cases, when both the stimulus and the two resonances are present at a considerable level, this amplitude modulation effect may occur between three frequency components. As the main component of the stimulus is removed, the amplitude modulation effects return to the dependence on the two resonant frequencies. Their initial level, both at the onset as at the offset is dependent on the wideband energy originally introduced by the stimulus.

The effects of an anti-resonance are similar to those demonstrated for a resonance. However, in the anti-resonant case the output spectral component at the frequency of excitation is reduced relative to the modal components, as expected from the fundamental behaviour of anti-resonances.

The case where the excitation frequency lies close to one single resonance is perhaps of little importance from a modal sound field standpoint as it only occurs in the presence of single resonances or when they are well separated in frequency, such as below the first room mode. The behaviour of such a system is similar to that shown for the resonance. However, when the stimulus is removed, the decay of such system shifts to its frequency of resonance and decay rate. This behaviour has been shown previously in the ambit of ported loudspeakers to extend low frequency response (Holland et al. 2003).

7.4 Subjective perception tests

The previous section illustrates the mechanisms underpinning the interaction between stimulus and resonant system. Consideration has been given to effects on objective factors that may be measured and observed in time and frequency responses.

This section aims to identify the perceptibility of differences caused by these factors. Two main aspects have been studied. These were the effects of the temporal structure of the input stimulus

and the effects of frequency alignment between the input stimulus and the resonant system. The experimental procedure follows similar techniques utilised for the subjective tests presented in Chapter 6.

The tests presented here utilise an ABX technique, previously introduced in Chapter 6, to evaluate the detection of differences between two audition samples. One experimental task compares the input signal to a modified version corresponding to the output of one of the resonant systems. A different task is conducted for the detection of differences between the outputs of two systems representing a different room situation.

It was decided to compare the effects introduced by *resonance* and *anti-resonance* cases depicted in Figure 7.4. These were chosen due to the different effects imparted to the stimulus, as demonstrated in section 7.3.3. The *off-resonance* case, where the excitation frequency lies between the in phase addition of the two modes, has similar effects on the stimulus. Hence it was chosen to test for the one where these effects are most noticeable – the anti-resonance.

All samples were normalised to the same peak amplitude. This is done in order to remove obvious perceptual effects associated with loudness. The Q-factor of the resonances is fixed at $Q=20$. This was chosen because it corresponds to an average value commonly found in small rooms with low absorption.

7.5 Results and discussion

The tests on the main experiment were carried out using six subjects. All subjects reported no hearing disabilities and had previous experience on listening and psychoacoustic tests. For each test case the subjects were asked to perform 10 trials, after which the results were recorded and a new test was started for a different case. Each subject performed a total of six tests with maximum duration of 20 minutes. These were carried out in a quiet environment, using headphones and a similar technique to that described in Chapter 6 was employed.

7.5.1 Effects of temporal structure of stimulus

Figure 7.25 shows the average results for the number of correct answers according to each stimulus. The result corresponds to the mean and standard deviation of the number of correct responses divided by the total number of trials, for each subject.

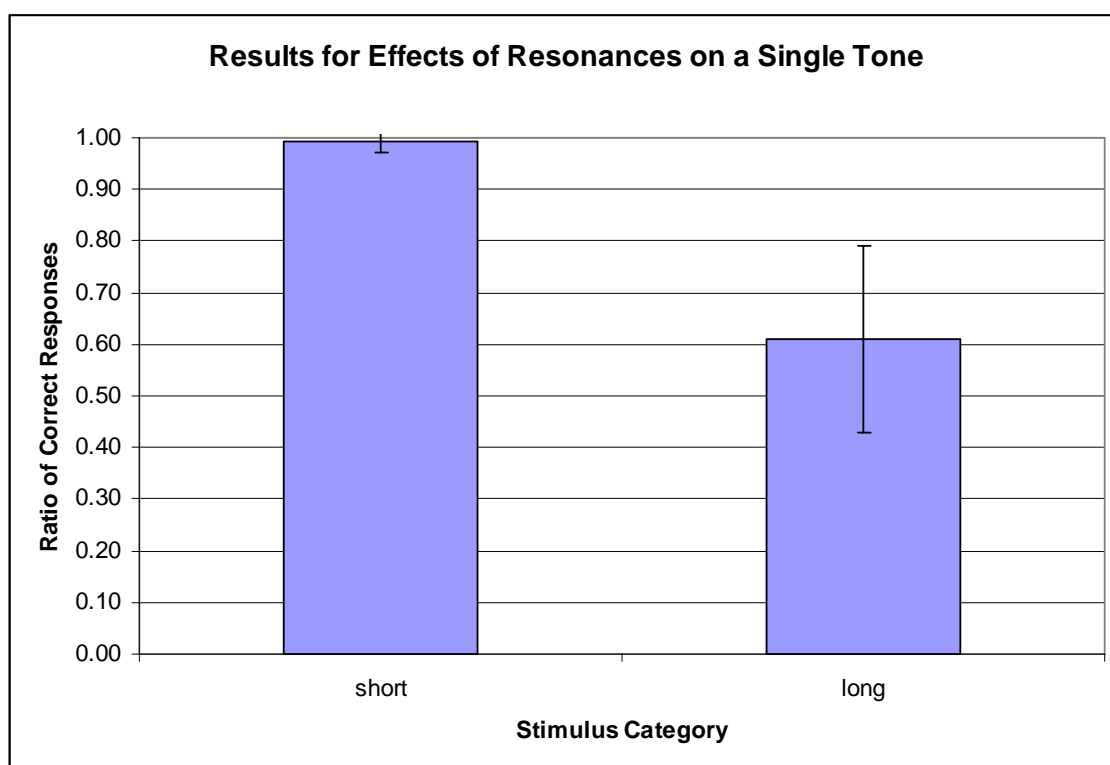

Figure 7.25 – Results for detection of differences grouped according to stimulus duration.

It is clear that the short stimulus originates almost a total number of correct responses across all cases studied. The average results for the long stimulus are close to 0.6, or 6 correct responses in 10, and also hold a much larger standard deviation. This result confirms that the temporal structure of the input is an important factor in the detection of resonances and that these effects are more audible in the presence of transient stimuli.

The distribution of this data is not normal, therefore preventing the use of a normal parametric ANOVA. Hence, an analysis of variance was performed using the *Friedman* non-parametric method (see Appendix IV.iv), as employed before on the analysis of data in Chapter 6. The parameters of the analysis may be found in Appendix Table 5 at Appendix IV.iv.

The result obtained for the effect of *stimulus* was:

$$p < 0.001$$

This extremely low probability value supports the fact that the effect of stimulus is highly significant in altering the perception of resonances. Therefore, it can be concluded that significantly higher values of detection are obtained when a short transient stimulus is used.

Figure 7.26 shows the results for each test case individually. The conditions compared are indicated under each pair of bars.

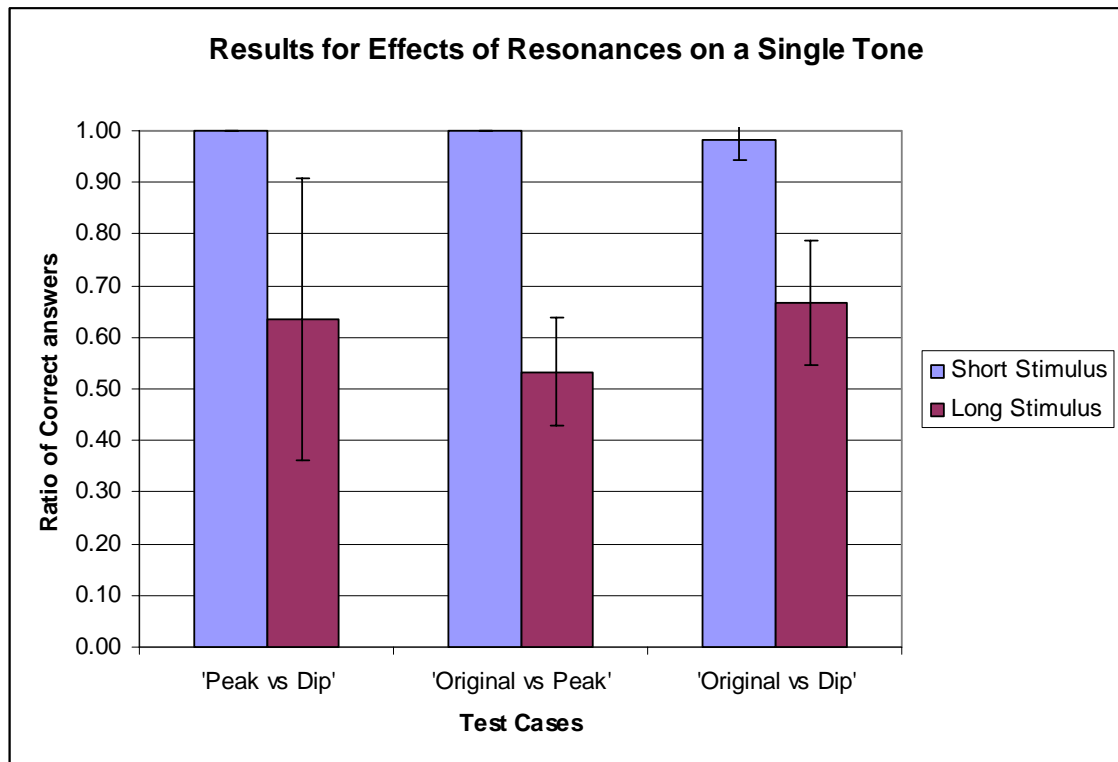

Figure 7.26 – Results for the detection of resonances on a single tone.

The results for long stimuli are clearly associated with higher levels of variance reflecting the uncertainty in detecting the effects introduced by resonances when long smoothly varying stimuli are used. Furthermore, there is not evidence of a difference in results between all cases where the short stimuli were used.

Table 7.1 shows the Chi Square test for the data in each test case. In practical terms this test indicates if subjects were able to detect a difference between the two audition samples in each case.

Table 7.1 – Chi Square test for each experimental case. Low values of p ($p < 0.05$) indicate statistical support that the results obtained are significant.

Stimulus	Short			Long		
	resonance vs. anti-resonance	original vs. resonance	original vs. anti-resonance	resonance vs. anti-resonance	original vs. resonance	original vs. anti-resonance
p	0.0000	0.0000	0.0000	0.0874	0.9449	0.4408

The value for p under each test case indicates the probability that the result was obtained by chance. All results obtained for short stimulus are highly significant ($p < 0.001$), whereas those for long stimulus are not significant ($p > 0.05$). In practice this means that subjects are only able to detect differences caused by resonances, when in the presence of short stimuli. The chi square result for the resonance compared to the anti-resonance case when a long stimulus is used is almost significant ($p = 0.087$). This indicates that there is a faint possibility of a detectable

difference between the cases where the room has either a resonance or an anti-resonance, even in the presence of long stimulus. However, the statistical evidence to support this is weak.

Overall, these results show a clear distinction between the detection of resonant effects on short or long stimuli. Subjects were consistently able to detect differences between samples when a short input stimulus was used. Conversely, in the presence of long stimulus subjects were not able to consistently detect differences between the cases in each test.

7.5.2 Effects of resonant response

This section analyses the results according to the effect of the resonant response in each system. Because the original input stimulus was only compared to a *resonance* or *anti-resonance*, these are the two cases relevant for this statistical analysis of variance. The results from the ANOVA indicate if the two results are independent, or if the means obtained represent the same overall value. The value obtained for the effects of resonance case was:

$p < 0.001$

The low value obtained denotes that the final results for each (*resonance* or *anti-resonance*) case are significantly different. According to Figure 7.26, the results for the short stimulus are very similar, therefore the identified significant variation has to be a consequence of the differences between each result obtained for the long stimulus. Consequently, it could be possible to conclude that subjects more readily detect differences introduced by anti-resonances as the mean value for this case is higher if compared for both the long stimulus results. However, as demonstrated previously, detection of the resonant effects is seriously impaired when long stimuli are used. Indeed, the results in Table 7.1 indicate that the data obtained for the long stimulus case is unreliable and should not be considered. Hence, from conflation of data and statistical analysis it is not possible to indicate a system that induces higher detection.

Although from a practical point of view, it would be informative to identify which of the two resonant systems produces higher detection, it is nevertheless important to establish that they do generate a different percept. This is indicated by the results obtained for the comparison of *resonance vs. anti-resonance* in Figure 7.26, which show that when the short stimulus is used, all subjects are able to reliably detect a difference.

In general, these results indicate that even if the auditioning level is equalised, the effects introduced by resonant systems, or indeed between resonances and anti-resonances, are clearly detectable in the presence of transient stimuli. Furthermore, this dependence of detection on the temporal behaviour of the stimulus suggests that any control methods that may attempt to

completely remove the undesirable effects of resonances by mere magnitude equalisation, are likely to fail, because temporal effects still remain.

7.5.3 Effects of Q-factor of resonances

Many of the more sophisticated control methods suggest that full removal of the effects of room modes may be effectively achieved if the Q-factor of resonances is reduced (Darlington et al. 1996; Avis 2002; Antsalos et al. 2003; Makivirta et al. 2003).

An additional short test was conducted to evaluate the effects of reducing the Q-factor of the resonant system. The effects of *resonance* and *anti-resonance* were tested for two auditors, who were asked to detect differences between the original stimulus and the system output. Audition samples were generated for the values of $Q=20$ and $Q=2$.

The experimental results are shown in Table 7.2. Each subject auditioned 10 trials for each experimental case. No statistical analysis is presented given the small number of subjects. In order to achieve a significant level of detection, a subject is required to detect at least 9 of the 10 auditions.

Table 7.2 – Results for the effects of Q-factor on the detection of resonances.

Subject	High Q		Low Q	
	Resonance	Anti-resonance	Resonance	Anti-resonance
A	10	10	7	6
B	10	10	7	8

The results clearly reveal that the detection of resonances is severely affected when the Q-factor is reduced. Full score is consistently achieved when the Q-factor is high. This demonstrates the high dependence of detection on the level of Q-factor.

7.5.4 Discussion of results

The results presented here indicate that the perception of resonances is highly dependent on the temporal content of the excitation signal. Considering that in most musical examples the signals are comprised of fast transients, with exemplary exceptions for quietly bowed instruments or slow attack synthetic sounds, the effects of untreated resonances will certainly be audible in most practical situations.

The objective study presented on the mechanisms underlying the interaction between resonances and single tones provides a realistic explanation for these results. Transient signals are characterised by large spectral energy outside their main frequency component. It is this wideband energy that is responsible for the strong excitation of resonances. Single frequency signals with a smooth temporal envelope have a reduced level of energy outside the main spectral component. The interaction with the resonant components of the system does exist, however, its effects are not clearly audible because the input energy at the resonant frequencies is of such small amplitude when compared to the stimulus level.

Another crucial effect has been identified from the influence that high Q-factor resonances have on the temporal response of transient signals. Such effect is revealed by an alteration in the attack and decay characteristics, and the introduction of amplitude modulation in the input stimulus. Evidence of its detection has been experimentally exposed by comparing original and modified sounds. In critical listening situations, this effect is highly undesirable as the reproduced sound is distorted from that originally existent in the recording medium or indeed in the recording environment.

In addition, it has been shown that if auditory level differences are removed, subjects are still able to distinguish the different effects caused by a resonance or anti-resonance. This suggests that the percept associated with these two conditions is different. This result is explained by the fact that the anti-resonance, as perceived in a room environment, is comprised of the interaction between two resonances. The spectral content between the two cases is therefore different, as the resonance case has only one single frequency. If only this spectral content is considered, it could be argued that in a real room situation, where the sound field has many resonances, there would be no detectable differences between the two cases. However, the objective differences between resonance and anti-resonance cases are also portrayed in the time domain response, where it is exposed that the existence of two resonances near the stimulus frequency causes an amplitude modulation effect, therefore different to that cause by a single resonance.

These facts support the idea that low frequency room correction methods should concentrate on reducing the temporal characteristic of the modes. A technique that solely addresses magnitude frequency irregularities is likely to leave evidence of the temporal effects, especially at the natural response of the room. In some cases, these effects may even be detected simultaneously to the stimulus as a form of amplitude modulation caused by the interaction of all the spectral components in the system. Any successful attempt to reduce the effects of resonances is more likely to be successful if their Q-factors are reduced, therefore modifying their temporal response characteristics. This has been demonstrated in a short experiment where a reduction of the Q-factor of the resonances has effectively removed the detection faculty.

7.6 Summary

This chapter has shown a study on objective effects of resonances in the presence of single tone stimuli. Models based on digital IIR filters were used to recreate the interaction effects between stimulus and room modes. The investigation was limited to cases where one or two resonances match the stimulus frequency or lie very close to it. The effect of resonances on single tones was initially studied from an objective point of view, with the aim of exposing objective behaviour in the time and frequency responses of the system.

It has been demonstrated that the interaction between resonances and single tone stimuli originates distortions in the output waveform of the system that are dependent on the type of resonant configuration. The extent of these distortions is clearly dependent on the amount of spectral energy present in the stimulus. Most of the effects are clearer when the input takes the form of a transient signal, such as an exponentially decaying sine wave. The effects observed range from a distortion of the onset and offset regions of the signal, associated with the long rise and decay times of high Q resonances, to the introduction of amplitude modulation, resulting from interaction between the resonant components and the stimulus.

The novel contribution on this chapter stands as a direct link between the objective factors described and their subjective implications. Subjective tests have been carried out in order to identify the perception of differences caused by the effect of resonances on single frequency tones. A clear effect is found to be associated with the temporal aspects of the input signal. In all cases studied, there is highly statistically significant evidence to support that the effects of resonances are best noticed when fast transient inputs are present. Furthermore, it may be argued that the temporal characteristic of stimuli whose amplitude envelope varies slowly, interferes with the ability to detect the effects introduced by resonances.

Comparison tests have shown that there is a perceptible difference between resonant system configurations even if the effects of amplitude are removed. This indicates that control methods that merely equalise the magnitude response in a room are ineffective in treating the problem of room resonances, given that the noticeable temporal distortions still remain.

Tests performed on the effect of Q-factor of resonances have shown that a reduction of this parameter effectively removes the perceptible effects on single tones.

These results indicate that methods that address the problem by controlling the Q-factor of resonances emerge as the most promising techniques to remove the undesired effects of room modes. For practical applications, a result for the difference limen for the Q-factor of room modes would indicate subjectively effective control targets. This subject is dealt with in Chapter 8.

8 Difference Limen for Q-factor of Room Modes

8.1 Introduction

Chapter 2 has reviewed a range of techniques currently available to solve the effects of low frequency resonances in small rooms. It is shown that active and passive control techniques both attempt to reduce the Q-factor of the room resonances, reducing the spatial and frequency variance associated with room modes. These control methods rely on the fact that an alteration in the Q-factor of the low frequency resonances will produce a noticeable change in the subjective perception of low frequencies.

In support of this, Chapter 7 demonstrates that the subjective effects of resonances are highly dependent on the temporal aspects of the input signal. These effects are revealed as distortions in the time domain responses of signals, which are readily detected when in the presence of transient stimuli. Finally, a short subjective test clearly demonstrates that, if the Q-factor of the resonances is reduced, the detection of effects on single tones is significantly impaired.

These findings are in accordance with previous research on the subjective perception of resonances (Bucklein 1981; Olive et al. 1997). These early investigations show that the detection of resonances is improved for transient signals and higher Q values (Q=10 and Q=30). This further supports that both the modal Q-factor and temporal behaviour of the stimulus are important in the detection of isolated resonances. Moreover, it also reinforces the notion that any control technique that attempts to remove the undesired effects of room resonances should take into account the temporal behaviour of the room response. It follows that the derivation of a difference limen is of extreme importance in providing control targets for any control technique and defining perceptually improved listening conditions.

An experimental technique is thus set up to define a difference limen for modal Q-factor. The results aim to provide more accurate information about the use of various absorption techniques for the control of low-frequency room modes. The subjective efficacy of a given control method may then be evaluated, from a set of known objective absorption characteristics. This will lead to a more efficient use of absorption treatments, reflected in economy of materials and space, and to the specification of suitable sound field targets for novel control regimes.

This chapter describes a procedure to extract the difference limen for the Q-factor of room modes in critical listening conditions. The concept of difference limen has been previously defined as “*The smallest detectable change in a stimulus*” (Moore 2003 p. 401). It is common to find *difference limen* results presented as a variation above or below a certain reference value, i.e. *reference ± difference limen*.

Furthermore, the experimental process of determination of a given difference limen often implies an evaluation both above and below a *reference* value. However, the experimental determination of such difference limen may involve *reference* values which are below the detection threshold of the factor under study. Under such conditions, an attempt to define the detection of a change *below* the reference is clearly unwise, and any result obtained may only be assumed to describe detection above the *reference*. This limen then defines a *threshold* of detection, as is the case in the following study.

It follows that the results presented in this thesis are somewhat different from the common *difference limen* concept and could rather be described as a *one-sided-limen*, given that values are determined for the detection of changes exclusively above each reference value. Given that this study concentrates on providing guidance to methods that attempt reductions to the Q-factor of room modes, this one sided difference limen is suitable.

As in Chapter 6, it was decided to use a virtual binaural representation of a real room, where music signals are used as the test stimuli. The choice of commercial music signals as the tests samples places the results in a more practical ground, which may then be used by investigators and room designers alike. Although the results should apply to any type of music, care has been devoted to choose a sample that contains transient signals with strong low frequency content. This study is carried out on a number of modes rather than isolated resonances. This will lead to a more generalised understanding of the behaviour of absorption on the low frequency range.

8.2 Binaural model of a listening space

The binaural model used here for the subjective tests is similar to that already described in Chapters 6 and 7. Moreover, the fixed and pre-determined high-frequency component of the audition samples is obtained in the same way as that described in section 6.4.1.

In this study, two high-frequency reverberation conditions were tested. One binaural impulse response has already been used in Chapter 6, and corresponds to a very low reverberation time (0.2 seconds), associated with some types of professional control rooms (Toyoshima 1986; Newell and Holland 1997). The other binaural impulse response was measured at a longer reverberation time (0.5 seconds), more closely related to listening room conditions (IEC 268-13 1985; BS6840-Part13 1987). These reverberation values are an average taken from measurements in the 250 Hz to 8 KHz bandwidth measured in a real room at different acoustic treatment stages of the room described in 5.2.1. The choice of two reverberation conditions was made in order to evaluate the masking effect of high frequency reverberation on the low-frequency difference limen of modal Q-factors.

The low frequency response inherent in the recorded binaural room impulse response is removed using a butterworth high-pass filter as described in Chapter 6.

8.2.1 Low frequency room model

The low frequency region for the audition samples is modelled using the technique already described in Chapter 7, which is based on digital models of room transfer functions using bi-quad IIR filters (Morjopoulos 1991). The room model used here is a digital approximation of the modal decomposition technique introduced in Chapter 3. The reasons for this decision are related to the fact that the damping factor in Equation 3.22 (Green's function) is derived directly from an average wide range (low frequency) value for RT, as given by Equation 3.4. In this chapter, the variable under control is the Q-factor of the resonances. Equation 3.22 and Equation 3.4 could be used together with methods based on inverse Fourier Transform, as employed in Chapter 6, in order to control damping conditions in the modelled sound field. It was however decided to employ a digital approximation of the sound field based on IIR filters, which allows direct control over the entire experimental range of Q-factor. The problems associated with assumptions of orthogonality and consequent restrictions in the use of large damping values still apply. In this chapter, and in order to test for conditions close to critical damping, the Q-factor of modes may assume very low values, which clearly violate the assumptions of the original modal decomposition models. This is an issue that is difficult to overcome when attempting to model conditions where high damping is involved. However, earlier research on the use of digital approximations of one-dimensional modal sound fields using IIR bi-quad arrangements has shown that although deviations increase for larger damping values, the degree of agreement is satisfactory, even where the termination impedance approaches specific acoustic value (Avis 2001). Furthermore, the models suggested in this thesis are used as a tool to create general conditions as those found in critical listening situations, rather than an exact replication of a sound field in a specific room. For this reason, and taking into account the advantages these methods afford for subjective testing, it was considered adequate to use such models.

As described in Chapter 7, each modal resonance in the room may be generated by a z-plane bi-quad IIR filter. The bandwidth of these filters is easily adjusted by varying the pole radius, and this will constitute the variable under test. In order to reconstruct a series of modes at different frequencies, the output of several bi-quads is added. The case of the 'pressure zone' in frequency or the 'zeroth' mode is modelled by designing a low pass filter using a real pole at an angle of 0° .

The difference equation for each resonant filter has already been introduced in Equation 7.1. Equation 8.1 represents the difference equation for the 'zeroth' mode.

$$\text{'Zeroth' mode - } y(k) = x(k) + x(k-1) + R_p y(k-1)$$

Equation 8.1

where R_p is the pole radius.

Figure 8.1 shows two Q-factor conditions at the model output.

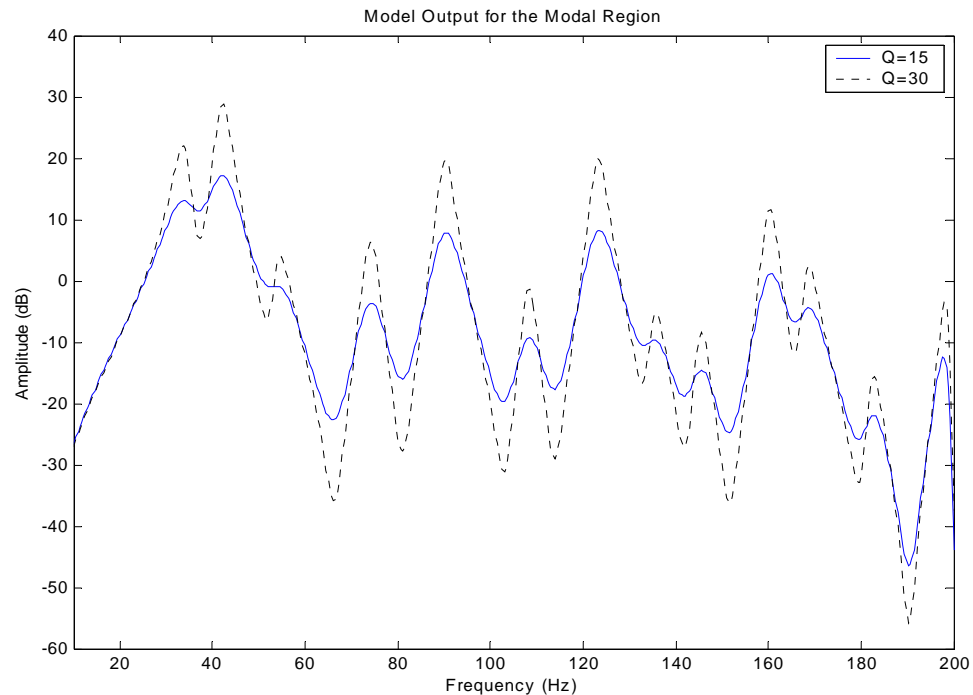

Figure 8.1 - Frequency response for two Q-factor cases of the modal response obtained using parallel addition of bi-quad IIR filters.

A batch of test samples ranging from minimum ($Q=1$) to maximum ($Q=80$) values of Q-factor was created previous to the running of the tests. The step size between each sample was set at $Q=0.25$. Although this was set previously to the determination of the DL, with hindsight this value was set much smaller than the expected DL, therefore with no repercussions to the obtained results. The creation of the audition samples was done using a computer program where each sample is written to a wave file. An automated test procedure was programmed to access these files and play A/B comparison pairs.

8.2.2 Forming a model room

The starting point in forming the model room originates in measurements taken in the studio control room described in 5.2.1, which was available during its construction stages. The modal amplitude and centre frequencies used in the model were taken from these measurements.

However, and because the objective of this test is not to model the ‘real’ room but to understand how changes to Q-factor are perceived, a selection of these modes were used in the model. Out of 17 original modes up to the Schroeder frequency, only 13 modes were included in the model to better reveal the effects of changes in Q. The centre frequencies and corresponding initial amplitudes are listed in Table 8.1 below.

Table 8.1 – Centre frequencies and gain for the modes included in the model. These settings were taken from measurements of a real room.

fc (Hz)	Gain
34	40
42	42
54	35
74	37
90	40
108	35
123	40
135	33
145	33
160	38
168	35
182	31
198	33

The Schroeder Frequency for the room has been previously determined at 200Hz. The mean modal Q-factor determined from the original room measurements was estimated at $Q_{(\mu,\delta)}=(17\pm 6.2)$, and a value of 20 was used as the reference in modelling the room. The modal response of the room is plotted in Figure 5.2. The conditions before the installation of low frequency control were used.

It follows that in order to obtain valid results from any subjective experimental technique, only certain parameters should be allowed to vary, whilst confounding parameters that are not under study should be fixed. For this experiment, only the modal Q-factor was varied. The assumptions this implies are described below.

At a fixed position in a fixed size room, any changes in the modal behaviour may only be associated with alterations to the damping characteristics. In order to maintain modal Q-factor as the only variable under test, the bandwidth of the modes is assumed to increase with frequency. This fact is translated to real applications as absorption increases proportionally to frequency and therefore higher order modes are more susceptible to the increasing effects of absorption in the room. Furthermore, it is assumed in this case that absorption is applied to control the entire range of the low frequency response, and therefore affect all modes. Hence, the assumptions for the present subjective experiment rely on the fact that changes in the

damping characteristics of the room will affect the Q-factor of all modes simultaneously and to the same degree. An experimental variation of modal Q value corresponds to altering the bandwidth of all modes by the same factor.

Another aspect to note in forming the room model is the amplitude of each mode. In the experimental room model, systematic changes are applied to the Q-factor as the single variable under test, given that modal amplitude and Q-factor are interdependent. The model defines modal amplitudes corresponding to the ones measured in the real room (Table 8.1). These are then affected by the changes applied to Q-factor. As the Q's of the modes change their amplitude is consequently affected (i.e. if the Q-factor of a mode decreases so does its amplitude). A change in level with no associated change in Q-factor would indicate a movement of the listener relative to the mode-shapes rather than a change to the boundary conditions, and this has been avoided.

Finally, and as in previous tests, all audition samples have been normalised to the same A weighted level.

8.3 Test method

The method used for the subjective experiments is similar to a 2-interval-forced-choice. Subjects were asked to listen to two music samples sequentially and state if there was any perceived difference between them. The samples in each audition will henceforth be referred to as *reference* and *modified*. The reference sample represents a fixed condition against which the modified sample is compared. Subjects were asked to concentrate on the sound at the lower end of the spectrum – ‘the bass’.

The process for extracting the difference limen for changes in Q-factor of the modes is of an adaptive type. The changes applied to the modified sample are decided in such a way as to achieve the final response in the least number of auditions. The PEST (Parameter Estimation by Sequential Testing) convergence procedure achieves this by applying a series of decisions that are dependent on previous answers (Taylor et al.1967). Figure 8.2 shows an example of the PEST answers for one of the subjects. The important point on the graph is the convergence of the answers towards what will be the difference limen for each case. The DL is defined as the arithmetic mean between the last two levels obtained.

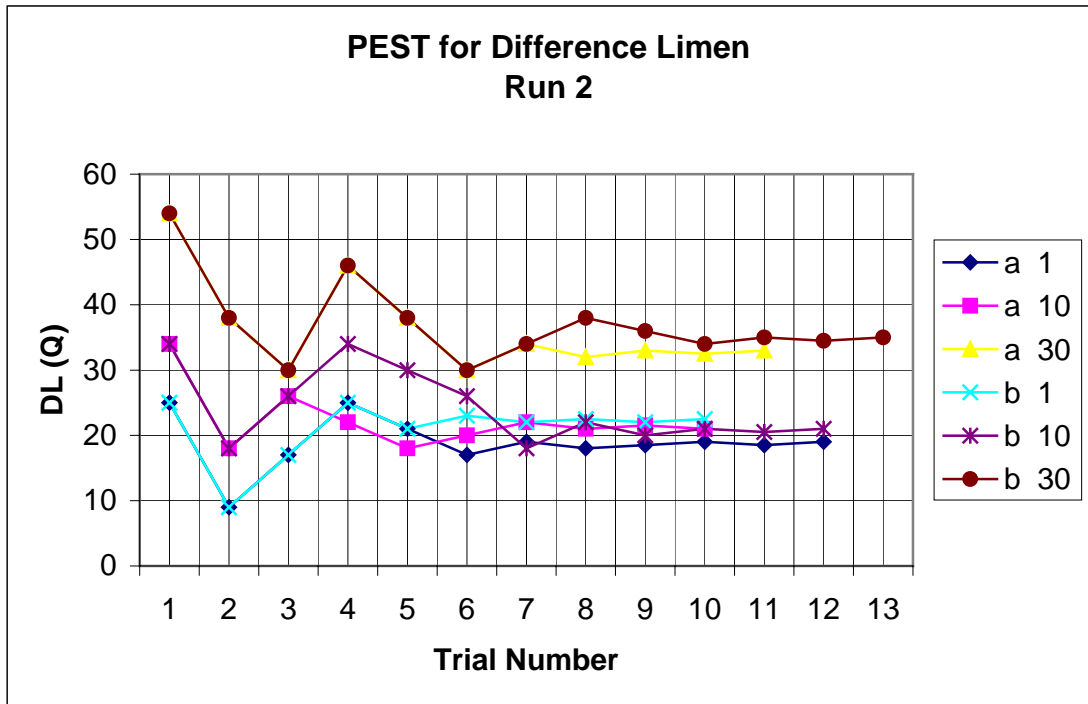

Figure 8.2 – PEST convergence results for one subject in all tested cases; a) Low RT, b) High RT.

The test variables are as follows:

Each subject was tested for two high-frequency (above Schroeder) RT conditions (short - 0.2 seconds and medium - 0.5 seconds), at 3 different *reference* Q values, low (Q=1), medium (Q=10) and high (Q=30). Each of the reverberation time conditions was tested independently. Hence, for each RT condition there were three reference Q levels (low, medium and high).

8.4 Results and discussion

The data was analysed in order to check for normal distributions. These normality tests are presented in detail at the Appendix IV.iii. It follows that all data was normally distributed and therefore the more powerful parametric analysis of variance (ANOVA) method may be used. All further analysis was carried out using a software statistical analysis package – SPSS for windows. This package displays various results in several tables. In order to provide a clear display of the most relevant data, all relevant tables are included in Appendix IV.iv. Only the applicable results of the main analysis are presented in this chapter.

The analysis of variance (ANOVA) identifies the significance and validity of experimental results. The factors involved in the ensuing tests are the *Reverberation Time* and three levels of reference *Q-factor*. The levels for each factor are described as *RT-Low*, *RT-Med*, *Q-low*, *Q-med* and *Q-high*. Each subject tested for these six cases and the full experiment was repeated three

times in different days. For the analysis these repetitions are called *RUN* and this will become another statistical factor. The tests were carried out by 10 subjects with normal hearing.

The preliminary analysis concentrates on the effect of *RUN* on the overall results. It checks if there was a significant effect of repeating the experiment on the final results. In practice, this indicates learning effects. The significance level for this factor is indicated in Table 8.2 under the heading ‘Sig. (p)’.

In this case the result is well above the statistical significance criteria of $p=0.05$. This indicates that statistically there is no significant effect of the factor *RUN* on the results. In practice this result shows that subjects were consistent across their 3 runs and that repeating the experiment has not led to a statistical significant difference in the final results.

Table 8.2– ANOVA including three factors; *RUN*, *RT* and *Q*.

Tests of Within-Subjects Effects	
Source	Sig. (p)
RUN	0.270
RT	0.008
Q	0.000

However, a further analysis carried out on the statistical results for each independent Run shows an interesting result. Table 8.3 shows the ANOVA results from each independent run. The value under the heading ‘Sig. (p)’ indicates the level of significance obtained for each factor.

Table 8.3– ANOVA results performed on each of the three runs individually.

Tests of Within-Subjects Effects(a)		
	Source	Sig. (p)
RUN1	RT	0.152
	Q	0.001
RUN2	RT	0.377
	Q	0.000
RUN3	RT	0.003
	Q	0.000

(a) for different runs

The value for p associated with the factor RT is above the accepted criterion, therefore there is a *non-significant* ($p < 0.05$) effect of RT for the first two *Runs*, and well below the criterion, therefore a *highly significant* effect of RT , for the last *Run* ($p < 0.01$). This is an important result as it indicates that as subjects become more trained, they are better at distinguishing different RT cases. Hence, a training effect is revealed, which is denoted in the results. In the context of critical listening rooms, the common case is that the user will be a highly trained listener and therefore, according to this analysis, sensitive to the effects of reverberation time on the perception of low frequency alterations. Therefore, these results indicate that for trained listeners the difference between levels of high frequency reverberation time will affect their detection of changes in the Q-factor of resonances.

Further analysis was carried out using Run number 3 of the set of data available. This decision was made based on the fact that at their third run, listeners form an expert panel, which is more representative of the standard in a professional critical listening situation. The standard deviation values are also found to be lower for this run indicating a better agreement between subjects' responses. Table 8.4 shows the arrangement of these factors for the analysis.

Table 8.4– Statistical factors for the analysis of variance.

Within-Subjects Factors		
RT LEVEL	REFERENCE Q-FACTOR LEVEL	Dependent Variable
Low	1	LOW1
	10	LOW10
	30	LOW30
Medium	1	MED1
	10	MED10
	30	MED30

Table 8.5 shows the results for the ANOVA performed on the data obtained in the third run. Inspection of the values under the heading 'Sig. (p)' reveals that the results for the factor RT are highly significant ($p < 0.01$). This indicates a significant effect of RT on the results for DL of modal Q-factor. In practice this means that the levels of reverberation induce different results in the difference limens obtained.

Further interpretation of results reveals high significance for the experimental factor Q ($p < 0.001$). This indicates that the experimental method has been successful in identifying the difference limen for Q-factor and that there are differences in the means obtained that depend on the reference values. The implications of this will be discussed further.

There are no significant interaction effects¹⁰ between the experimental factor RT and the experimental factor Q ($p > 0.05$ for RT*Q). This means that the level of RT does not change the trend of results obtained for the DL. In other words, the trend verified in the results obtained as *difference limen for Q-factor* is the same regardless of the *RT level*, even though the mean values obtained differ between the two RT cases.

Table 8.5 - ANOVA for Run number 3.

Tests of Within-Subjects Effects	
Source	Sig. (p)
RT	0.003
Q	0.000
RT*Q	0.079

Table 8.6 shows the Difference Limen for modal Q-factor for each of the cases tested. Figure 8.3 shows this data graphically.

Table 8.6– Difference Limen for Q-factor in room modes.

Descriptive Statistics			
RT	Q-factor	DL	St. Dev.
Low	1	15.3	5.8
	10	7.8	2.9
	30	5.3	2.8
Med	1	17.8	4.9
	10	12.4	3.9
	30	6.7	2.7
Average for DL for Q-factor			

It is clear that the difference limen increases with decreasing Q-factor. Additionally, the values for the difference limen at medium RT are higher than those for the low RT case.

¹⁰Interaction effects - 'A significant effect where the effect of one factor depends upon specific levels of another factor' (Coolican 1999, p.420)

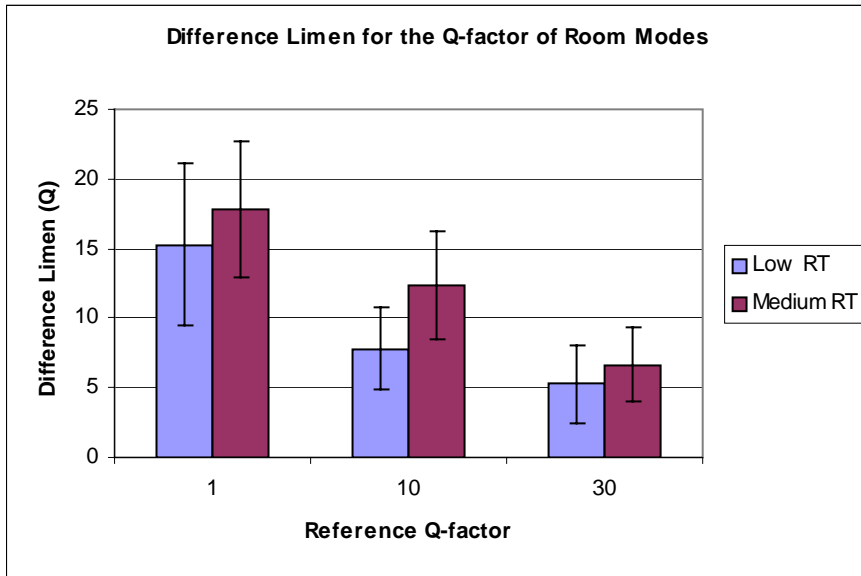

Figure 8.3 – Results for the difference limen for the Q-factor of room modes.

In practice these results indicate that subjects were able to detect a smaller change in the parameter Q-factor at higher levels of Q. For room applications this indicates that as the desired level of Q decreases, the amount of change necessary to obtain a perceptible difference becomes larger.

In the case of the reverberation time these results indicate that it is more difficult to perceive a difference at higher mid-frequency RT levels. Hence, in room applications, it may be important to have some high frequency energy that will to some extent ‘mask’ the effects of low frequency resonances. Conversely, in order to produce a perceptible difference at low frequencies, the effective change on the Q-factor of the room modes needs to be larger in rooms with a higher mid-frequency reverberation time.

In order to obtain a generalised and applicable value for the DL for Q-factor, the average values across the two reverberation time conditions may be used. The implications of this assumption may be investigated by determining the average difference between the two reverberation cases. The average results for the reverberation time conditions are shown in Table 8.7.

Table 8.7– Average values for Q-factor difference limen at two RT cases.

Estimates(a)				
Measure: MEASURE_1				
RT	Mean	Std. Error	95% Confidence Interval	
			Lower Bound	Upper Bound
Low	9.4	0.98	7.2	11.7
Medium	12.3	0.94	10.1	14.4
a. RUN = 3.00				

Statistically, the difference between the two RT cases has been proven significant (Table 8.5). However, the result above shows an average difference of approximately 3 in Q-factor. This is in practice a very small difference and indeed much smaller than any of the DL presented on Table 8.6. It is reasonable to assume that for the generalisation of a difference limen for the Q-factor in room modes, the small effect of reverberation time may be disregarded. Table 8.8 shows the values calculated for the different levels of reference Q averaged across the two RT cases.

Table 8.8– Average values for Q-factor difference limen at three reference Q cases.

Descriptive Statistics			
Ref. Q	1	10	30
Average	16.5	10.1	6.0
St. dev	5.4	4.1	2.8
Global Average DL for Q-factor			

It is important to note that the deviation obtained is larger as the reference Q decreases. This further reinforces the idea that the subjective effects of changes in Q-factor become increasingly unclear as the reference level decreases.

Further trends are indicated from the analysis on the raw data. Results suggest that there is a highly significant probability that the difference limen for Q-factor follows a linear trend. This is indicated in Table 8.9, under heading ‘Sig.’ for factor Q.

Table 8.9 –Tests for Linear Trends in experimental data.

Tests of Within-Subjects Contrasts(a)		
Source	Q	Sig.
Q	Linear	0.000
	Quadratic	0.197

Following up on this statistical significant result, a prediction of the expected difference limen may be generalised across a range of Q-factors. This may be obtained by calculating the line of best fit in the available data. Figure 8.4 shows the experimental results determined for the DL (from Table 8.8) and a generalised trend obtained from a best line regression fit.

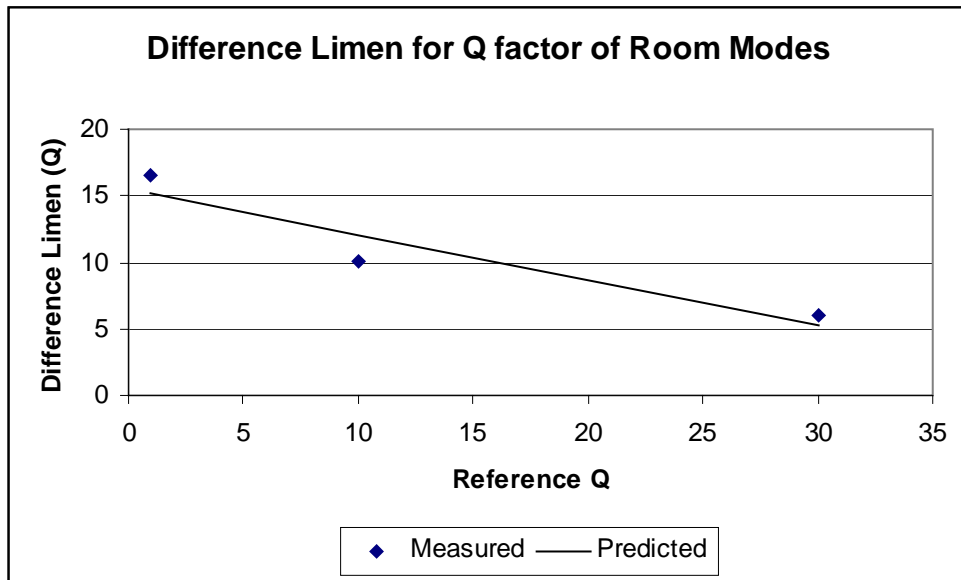

Figure 8.4 – Data representing a generic difference limen for the Q-factor of room modes. Experimental data contrasted with a regression analysis prediction.

Given the small number of data points, this extrapolation is clearly indicative rather than conclusive. More data points would, of course, be required to provide a better confidence on the linear relationship between Q-factor and difference limen.

Earlier work by Olive et al. (1997) suggests that modal detection in the steady state is *inversely* proportional to modal Q, but using square pulses the detection is *directly* proportional to Q-factor. Even though this experiment differs significantly in the methodology of establishing modal ‘detection’, it can be seen that the current results support the idea that modal *decay* rather than frequency-domain variance provides the major cue for resonance audibility, and that music contains sufficient impulsive content to facilitate this mechanism of modal detection.

The difference limen results presented here, indicate target values for a perceptible change in the modal sound field of a room. These values are presented in terms of alterations to the Q-factor of resonances over a wide low frequency bandwidth. A direct application of the results derived here requires information about the changes to the sound field in some form that could be extrapolated to Q-factor differences.

However, due to the extensive use of reverberation time descriptors to characterise acoustic conditions of rooms, a time-based metric has led to a more intuitive understanding of any changes in a given sound field. It would therefore, be more appropriate to present results in terms of a difference limen for modal decay. It has been referred in Chapters 5 and 7, that the modal Q-factor has a direct relationship with the decay of a resonance, and that this relationship, in room situations, may be described by a simple expression:

$$RT = \frac{2.2Q}{f_0}$$

Equation 8.2

It should be noted however the interdependence between decay or Q and the centre frequency of the mode. Therefore, an indication of a single difference limen in terms of decay time would still be inadequate as the apparent 'equivalence' of decay rate across frequencies has not been under study.

Extrapolation to decay times at different frequencies is possible, although it should be taken with caution and only used as indicative rather than definitive. Table 8.10 shows the corresponding changes in decay time extrapolated from the difference limen determined. These are determined for each octave band centre frequency in the low frequency range.

Table 8.10- Decay rates (in seconds) for experimental difference limen of Q-factor. Reference Q value for each case is indicated.

ref. Q value	Difference Limen	Frequency		
		32 Hz	63 Hz	125 Hz
30	6	0.41	0.21	0.11
10	10	0.69	0.35	0.18
1	16	1.10	0.56	0.28

These values are plotted in Figure 8.5 for clearer analysis.

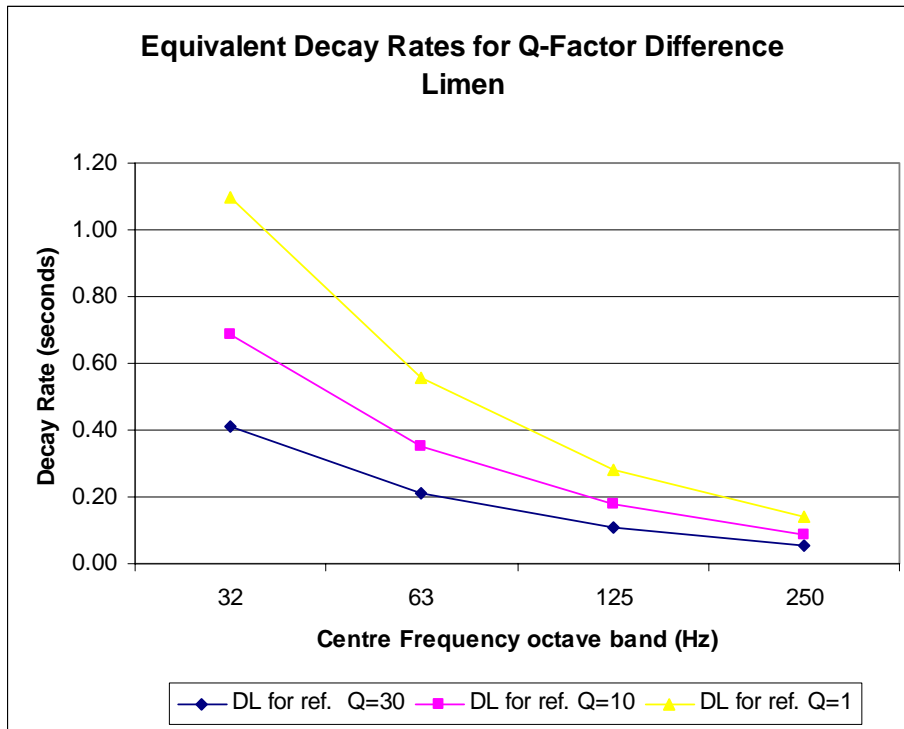

Figure 8.5 – Equivalent decay rates for the experimental Q-factor difference limen. The decay rates are calculated for each octave band centre frequency of the lower auditory range.

Figure 8.5 shows that as the target decay time decreases (Q=1), larger changes in decay rate are necessary to produce a perceptible difference. Furthermore, the relationship between Q-factor and centre frequency is such that in order to obtain noticeable differences, the required changes in decay rate become larger as frequency decreases.

Figure 8.4 shows an intercept in the region Q=16. This suggests that using this data set, a modal Q of at least 16 is required to detect the presence of a resonance, and that modes with lower Q will not be detected, since they will not be differentiable from the case where Q=1 – critical damping. Q=16 is therefore the threshold value below which any further room treatment would be unnecessary. According to the extrapolated values in Table 8.10, this value of Q corresponds to a decay rate of 1.1 second at 32 Hz. In practice, this indicates that a target of around 1 second at the lowest measurable frequencies in a room may provide adequate subjective control of the

sound field, since shorter decays are no longer noticeable. However, this threshold value decreases considerably with increasing frequency, and to achieve the same subjective control at 125 Hz, a decay rate of 0.28 seconds is necessary.

It is important to note that these results assume that Human perception of decay times has a correspondence across frequency according to Equation 8.2. Therefore, the extrapolations to decay times may not be entirely correct, as the detection values obtained for Q may be biased on the changes at the higher modal frequencies.

It has been suggested by Moore (2003 p. 177) that the shape of the auditory filter may play a role in temporal detection. An estimate of the auditory filter bandwidth is given by (Glasberg and Moore and cited in Moore 2003):

$$ERB = 24.7(4.37F + 1)$$

Equation 8.3

where F is the centre frequency given in KHz.

Shown in Table 8.11 are predictions for equivalent rectangular bandwidths in three octave band centre frequencies. Corresponding Q-factors and decay times are also indicated.

Table 8.11 – Equivalent Rectangular Bandwidth of auditory filter and corresponding Q-factor and decay vales for low frequency octave bands

fc (Hz)	32	65	125
ERB (Hz)	28.15	31.72	38.19
Corresponding Q	1.14	2.05	3.27
Corresponding Decay (s)	0.08	0.07	0.06

It is clear that the bandwidth of the auditory filters is associated with an increase in decay times as frequency decreases. According to Moore, this ‘ringing’ property of the auditory filters has been suggested to interfere with mechanisms of temporal detection. Furthermore, and as mentioned previously, the detection of gaps in sinusoids increases considerably from a constant mid-frequency value of 6-8ms to 18ms at the lower frequencies. This rise in decay time further supports the idea that the detection of changes to the decay of sound fields in rooms may become progressively worse as frequency decreases, as suggested in Figure 8.5.

A comparison between the experimentally defined DL for Q-factor (Table 8.8) and the predicted Q-factor for the ERB shows that the DL results are invariably higher. This result is expected as the task of detecting changes in modal Q-factor of sound fields, when in the presence of a complex stimulus, differs significantly from tasks of gap detection or frequency masking, as

used to derive the ERB. Indeed, the experimental results show that the limen is reached at values larger (>100ms) than the suggested 'ringing' of the auditory filter (18ms) further supporting that the detection of changes to sound fields in critical listening conditions is considerably different to that which could be found through more conventional experimental methods.

More, recent results by others researchers have been presented on the detection of changes to a single resonance in the presence of a fixed modal sound field. Karjalainen et al. (2004) report a dramatic deterioration of detection below 100 Hz in excess of 2 seconds, but a fairly constant JND¹¹ of 0.2 to 0.3 seconds in the range of 100 Hz to 800 Hz. The results presented in this chapter agree to some extent with those found by Karjalainen et al., although the extrapolated decays for the lower frequencies presented here are much smaller. The techniques used for both investigations differ considerably both in concept as in method. The determination for the detection of changes in single modes is important from a control standpoint but perhaps less informative for critical listening room psychoacoustics as encountered in typical conditions.

Results by Niaounakis et al. (2002) report a DL for changes in RT of small rooms in the order of 0.05 seconds. Even though the frequency range or indeed the methodology used in this chapter are quite different, a considerable rise would be expected towards the low frequency end, similarly to what is demonstrated in Figure 8.5. The trends presented here suggest that the DL would decrease in frequency and converge to an average value at higher frequencies where a large number of modes exist and overlap. Although a direct comparison is not possible, the results presented by Niaounakis et al. (2002) and those presented here are not contradictory.

Furthermore, comparison of the present results to the IEC recommendations (IEC 268-13 1985) for listening room conditions is sympathetic. However, since the recommendations are strongly dependent on the mid-frequency RT of the room, there is a danger that for rooms with very low RT, the recommended values for low frequencies become too restrictive.

A final word of note should alert the reader that the results obtained correspond to resonances in the presence of musical signals and for the whole modal range. Substantial differences are to be expected if more discrete test signals, with no masking effects from other frequencies, are used. Nevertheless, the purpose of this chapter and indeed of the work presented in this thesis is to derive results which are applicable to real room situations, where the subjective certainty may not be as high but more indicative of real applications.

¹¹ Just noticeable difference.

8.5 Summary

A difference limen for the perception of Q-factor in room modes has been experimentally defined. The results show that in order to ensure subjective perceptibility of Q-factor alterations, increasingly large changes in Q are required as the room tends towards a ‘dead’ response. The masking effect of reverberation at higher frequencies is noticeable in terms of a modification of audibility of changes in low-frequency modal Q. Higher levels of reverberation translate into a decrease of detection.

A generalised metric for the definition of modal Q-factor difference limen has been proposed. This indicates that reductions to the Q-factor below a value of 16 will be subjectively imperceptible and this may be defined as an indication of the lower threshold beyond which any additional room treatment may be redundant. The difference limens obtained are 16 ± 5.4 , 10 ± 4.1 and 6 ± 2.8 for reference Q of 1, 10 and 30 respectively.

Although the methodology used to extract the difference limens is based on the Q-factor quantity, an indication of analogous results in decay rates is given as a more intuitive measure of the subjective detection of changes. This analogy is somewhat imprecise, as the apparent ‘equivalence’ of a decay rate across frequencies is still largely unknown. A translation of the identified DL for Q factor shows that a decay rate of 1 second or less at 32 Hz would be unnoticed by listeners. This corresponding ‘decay difference limen’ is shown to decrease rapidly with increasing frequency. The findings presented here are in agreement with previous research on the perceptibility of resonances and perceptibility of changes in reverberation time, although the current recommendations for the acoustic conditions of critical listening spaces contrast as slightly restrictive in the case of rooms with very low mid-frequency RT.

The results for the difference limen may be used as control targets for techniques that ameliorate the problem of room modes leading to a reduction in cost and use of space in critical listening room design.

9 Conclusions

9.1 Introduction

An investigation has been presented on the problems caused by room modes in critical listening spaces. Its purpose has been to further develop the knowledge on the subjective perception of modes in rooms in order to guide in the design of better control techniques, which as a consequence will improve the conditions in high-quality rooms for sound reproduction.

The emphasis of this work has been placed on the subjective perception of factors that affect the reproduction of low frequency audio in rooms. These factors have been identified in prior research and form the available control parameters over which treatment techniques, either passive absorption or active control, exert some influence.

The conclusion, main findings and implications of this investigation are presented here.

9.2 Results from a qualitative study into the views and preferences of control room users

The methodology applied in this study was first to gather empirical evidence and identify the reality of the problem of room modes by conducting a qualitative study on individuals performing monitoring tasks at a high-standard professional level in the audio industry. Most of the problems identified during this study, have been found to have a direct link with the idiosyncrasies caused by room modes. These problems have been reported to directly affect the optimum performance of these professionals in their working space.

From this study, a number of general issues were found to be connected with the problems introduced by room modes. These issues were:

- Long resonant decays that alter the perception of transient sounds and inhibit the monitoring of lower level reverberation in the original material.
- Imbalances in frequency that result in recurrent errors on the spectral balance of the final product.
- Large variations of low frequency sound ‘quality’ within the listening area.

- The use of smaller, frequency restricted, monitor systems to avoid the large low frequency variations between rooms when using full-range monitoring systems (often flush mounted).
- Uncertainty about the overall ‘accuracy’ of sound monitoring due to poor translation¹² into other listening environments.

The identification of these problems in professional audio facilities has indicated that the current state-of-the-art room design is still failing to provide rooms where monitoring procedures are performed comfortably and unhindered by problems caused by resonances. Furthermore, the above remarks indicate the extent of the problem in hindering a correct perception of the reproduced sound and leading to the adoption of alternative methods, such as the use of personal monitors, that may in fact introduce more problems unknown to the user.

In order to gain further knowledge and provide better guidance in the design of perceptually accurate rooms, a study into the subjective effects of room modes was thus justified.

9.3 An investigation into modal control techniques

As a means of obtaining more empirical evidence on the difficulties of modal control, a practical study into the low frequency control of rooms was carried out using two different approaches. The main findings from this study are described below.

9.3.1 Modular resonant membrane absorbers

The investigation into the use of modular resonant membrane absorbers to control the low frequency sound field in rooms has shown that:

- Membrane absorption mechanisms may provide a means of ‘removing’ modal energy, reducing their decay times and decreasing their quality factor.
- The positioning of such devices is critical and improved performance is achieved when the devices are placed at high-pressure zones of the mode-shapes to be controlled.
- A large amount of absorption area is needed for each ‘treatment’ frequency, which renders the placement of large amounts of absorbers problematic, resulting in a reduction of the number of dedicated ‘treatment’ frequencies.

¹² ‘Translation’ is a term often used to describe how similar a certain piece of finished audio work sounds when replayed through another system in another environment.

Interesting relationships between common forms of displaying measured data describing room performance have emerged during this investigation. More specifically, it has been observed that although considerable changes in the decay times at low frequencies were obtained, this improvement was not clearly revealed by the magnitude frequency responses measured in the room. Indeed, changes have been observed in the magnitude frequency response, but these did not correspond entirely to the usual indication of an improvement by removing the large amplitude variations caused by resonances, e.g. ‘flattening’ of the magnitude response. This indicates that the analysis of a sound field will be severely curtailed if only magnitude frequency responses are provided. This result has repercussions to other areas of the audio industry, such as loudspeaker design, where the performance of products is commonly evaluated merely from magnitude frequency responses.

9.3.2 The distributed mode loudspeaker as a low frequency radiator

The investigation on the use of distributed mode loudspeakers as low frequency sources in rooms originated in the growing interest in these devices by the audio industry associated with earlier research evidence that large vibrating plates at the boundaries of a space improve its low frequency behaviour by damping and modifying the excitation of resonant modes.

The peculiar radiating behaviour of distributed mode sources was explored in order to excite the room modes in a different way to that of conventional loudspeakers, and attempt to achieve a more controlled modal sound field. This investigation was supported by the use of prediction models, using newly derived analytical expressions for the inclusion of simply supported plates as sound radiators in rooms. These expressions permit the interaction of distributed sources and modal sound fields to be studied. A numerical technique was also employed that allowed the study of plates with more complex boundary conditions. Preliminary simulations have shown that, for the purpose of the investigation, the sound field differences produced by changing the plate boundary conditions were not significant.

A further study concentrated on an investigation of the interaction of a large plate and the modal sound field created in a duct. It was shown that, under specific plate conditions, the magnitude of excitation of a single axial mode might be reduced by about 15 dB, when compared to point source excitation. Indeed, this result was further confirmed by a reduction of about 10 dB in the spatial variation of pressure at the eigenfrequency in question. Despite this apparent improvement in modal excitation, it was identified that this reduction was obtained by matching a specific plate mode-shape with the frequency of the first mode in the duct, therefore ascribing the lower excitation level to a reduction of the effective radiating area rather than its distributed behaviour at higher frequencies. Indeed, similar or even better results are currently obtained by active techniques using secondary sources.

Moreover, experimental results have shown that the introduction of plate resonances at other frequencies is responsible for very long decays in the time response of the duct, which negate the benefits obtained. Once again it is clear that time as well as magnitude frequency response data must be evaluated in order to judge the impact of a modification to the system under study.

The predictions for a large plate in a normal size room have led to similar conclusions. In this case, the plate was defined to exhibit high modal density in the lower frequency range of the room. Prediction results have shown that the introduction of extra plate resonances appears at first to be beneficial given the increase in the modal density of the room. However, an analysis of the time response shows, yet again, the long decays associated with the lightly damped plate resonances. The consequent increase in decay time of the room renders this solution inappropriate. Increasing the damping in the plate ameliorates this particular problem; the decay time in the room is reduced to similar values as found for the conventional point source excitation. However, this also means that any improvement over point source excitation is lost.

It follows that no benefits were found in using distributed mode plates to achieve a more controlled modal excitation. Moreover, if the damping on this type of source is not controlled, the problems introduced may actually make the situation worse.

Despite these results, the study has provided valuable information regarding practical issues related to the control of room modes. Namely, it was found that efficient control should reflect a decrease in decay time measured in the room, and that alterations in the magnitude frequency response may not necessarily translate into an improved sound field. The results from this study have raised hitherto neglected questions regarding the perception of low frequency parameters and the consequent subjective evaluation of control techniques. In particular, the importance of issues such as modal distribution and temporal decays have been highlighted. These were addressed in an investigation into their subjective perception.

9.4 Subjective perception of room modes

This thesis has highlighted the central importance of a full understanding of the perceptual ramifications of modifications to the low frequency sound field. It has also been shown that the existing literature does not comprehensively address this requirement. Therefore, a study of a number of highly significant subjective factors was conducted, which together form the major contribution of this thesis.

9.4.1 Results for the perception of modal distribution

The results from the study carried out on the subjective effects of modal distribution have shown that although changes are consistently detected, any ranking of preferred aspect ratios describing the low frequency ‘quality’ of a room may be subjectively meaningless. Significant detection of changes produced by alterations in aspect ratios can be measured. However, these occur even between conditions with very similar scores on each of the metrics studied. Therefore, the ranking of aspect ratios that describe subjective quality of rooms has been contested, and subsequently, the definition of a difference limen for these is bound to be unsuccessful.

The high detection rate identified in the experiments has been associated with the fact that the detection of resonances in rooms is more closely related to the match of single musical notes with specific features of the room response – both in frequency and in time. This explains why even rooms with aspect ratios considered optimum (i.e. scoring high on a given metric) still generate high detection of resonant problems.

The usefulness of defining aspect ratios as a means of controlling the problems of room modes is therefore undermined by other more important perception factors such as frequency and time domain modifications to particular musical artefacts within the stimulus. A study was thus carried out on the effects of resonances on single tones.

9.4.2 Results for the effects of resonances in single tones and the importance of temporal information

The study on the effects of resonances on single tones has generated important results that provide a further understanding of these, both objectively as subjectively. Simulations have demonstrated that even if the amplitude of different resonant systems is ‘equalised’ at the frequency of the input tone, there are still evident differences in the time and frequency responses.

Initially, an objective study has shown that the effects of resonances are much clearer in the presence of transient signals. Perhaps not surprisingly, the alterations appear as temporal distortions of the original signal. Additionally, it has been demonstrated that these are less noticeable on the time response of signals with slow varying amplitude envelopes. In the case of resonances that match the frequency of the input signal, a clear distortion appears as an increase of the onset (‘attack’) and offset (‘decay’) times. This effect is associated with the high Q-factor of the resonances that prevent the system from responding instantaneously to the fast amplitude

variation of input stimuli. In this case, no evidence of other frequency components is found in the power spectra, given that both stimulus and resonance have the same frequency.

Anti-resonance (generated by the residual interaction of resonances as found in rooms) and off-resonance excitation share similar characteristics between them. These are revealed by the appearance of the resonant frequency components in the spectral response of the system. In this case, an amplitude modulation effect is also noticeable on the time response, which is similar to the phenomena of first order beats commonly found between two tones with similar frequencies (~ 5 Hz). An interesting point to note is that the anti-resonance appears to modify the temporal behaviour of the stimulus less markedly than the other cases tested.

The above-mentioned effects have been objectively demonstrated in the time and frequency domain plots. Another technique used to display the response of the system has been demonstrated known as *power spectral decay*, and allows the visualisation of spectral changes with time. This has shown some interesting effects, such as the transfer of energy from the frequency of the input stimulus into the resonant frequencies of the system at its natural response stage. Once more, this demonstrates that even if the amplitude of a system is equalised during the steady state response, the effects of resonances will appear when the input stimulus is removed and the room decays at its natural resonant frequencies.

The subjective perception of these effects was investigated in a series of dedicated tests.

Initially, it has been shown that the temporal content of the input signal is a significant factor affecting detection. It was found that, in the presence of slow amplitude varying stimuli, the effects of resonances are not detected. Conversely, with impulsive signals, more representative of music, these effects are clearly revealed.

Experimental results have established that the distortions imparted to an original transient signal are detectable for both resonance and anti-resonance conditions as experienced in rooms. Furthermore, it has been shown that there are perceptible differences between these two cases even if they are presented at the same amplitude. The implications of these results are that in the presence of transient stimuli, the effects of resonances are clearly noticeable, and depend on the configuration of the system. This supports previous conjecture, where it was suggested that the detection of differences between rooms was dependent on the alignment between individual notes of the raw stimulus and the response of each room at or near the specific frequency of those notes.

A further test was carried out in order to identify the effect of Q-factor of resonances on the perception of alterations imparted to the original stimulus. This was tested for both resonance and anti-resonance cases. It has been shown that, even in the presence of transient stimuli, a

decrease in Q-factor of the resonances drastically reduces the ability to detect differences between the original signal and the output of the resonant system.

Following this, it can be concluded that if the differences in amplitude are removed, the effects of resonance on simple signals are still noticeable. Furthermore, significant reductions in detection are achieved when the Q-factor of the resonances is decreased.

Given this, it was considered meaningful to derive a difference limen for changes in Q-factor.

9.4.3 Results for a difference limen for the Q-factor of room modes

The difference limen for the perception of changes to the Q-factor of room modes has been identified. The effects of mid-frequency reverberation levels on the ability to detect changes in the Q-factor of low frequency resonances were also investigated.

Results have shown that the level of mid-frequency reverberation has a significant effect on the difference limen of Q-factors, reducing these by an average of Q=3 for lower reverberation times. This indicates that mid-frequency reverberation time (0.5 seconds in the experimental case) may be important in masking the undesired effects of resonances. Conversely, perceptible low frequency ‘treatment’ in rooms where the mid-frequency reverberation time is very low (0.2 seconds) is less demanding, given that changes to the modal sound field are more readily detected under these conditions.

The difference limen for the Q-factor of room modes were determined for three different reference Q levels and are shown in Table 9.1. The reader is reminded that these values correspond to *one sided difference limen* indicating the variation *above* the reference value, necessary to produce a significant detection of change.

Table 9.1 – Average values for the difference limen of Q-factor in room modes

Descriptive Statistics			
Ref. Q	1	10	30
Average	16.5	10.1	6.0
St. dev	5.4	4.1	2.8
Global Average DL for Q-factor			

The results indicate that it is increasingly difficult to detect changes as the value of target Q-factor decreases. In practice, this means that it gets progressively more challenging to ‘treat’ the problems of rooms modes as the response in the room tends to lower decay times. Furthermore, it is suggested that treatment that achieves Q-factors of about 16 is sufficient, given that this case is not subjectively distinguishable from the case of critical damping, i.e. Q=1. An extrapolation of these values of Q-factor into corresponding decay times was presented, in order

to compare the obtained results with a more intuitive descriptor of the acoustic quality of rooms – low frequency modal decay time, as the analogue of higher frequency diffuse field reverberation time. These extrapolated results suggest that a decay time of around 1 second at 32 Hz would provide enough low frequency control for any room, given that shorter decays would not be distinguishable. However, the underlying Q-data corresponds to a much shorter decay time of 0.28 seconds at 125 Hz. The frequency-dependence of the difference limen has not yet been formally evaluated, but it can be inferred that at very low frequency results suggest that current room treatment guidance is unnecessarily demanding. As frequency increases, these results concur more readily with existing design guidance.

The threshold result of $Q=16$ may be used further to extrapolate the necessary acoustic absorption to ensure subjectively sufficient control of a single mode. It should be noted however, that the general assumptions commonly associated with absorption coefficients¹³ do not apply here and as such its derivation has to be based on the decay of a single mode in the room. Morse (1948) has derived this, and it has also been presented by Angus (1999) in a simple manner. The decay of a single mode may thus be determined from:

$$T_{MODAL} = \frac{-0.04L_{MODAL}}{\ln(1 - \alpha_{MODAL})}$$

Equation 9.1

where L_{MODAL} and α_{MODAL} correspond respectively to the distance between the reflective surfaces associated with the specific mode; and its average absorption coefficient assuming symmetric absorption conditions.

L_{MODAL} is easily defined if the mode in question is axial. In the case of oblique or tangential modes, the length may be defined from:

$$L_{tangential} = \frac{1}{2} \sqrt{length^2 + width^2}$$

Equation 9.2

or

$$L_{oblique} = \frac{1}{3} \sqrt{length^2 + width^2 + height^2}$$

Equation 9.3

¹³ The derivation of absorption coefficient as originally defined by Sabine assumes diffuse field conditions and random incidence of the sound wave.

From Equation 9.1 and Equation 3.1 an average modal absorption coefficient may be derived as:

$$\alpha_{MODAL} = 1 - e^{\frac{-0.04L_{MODAL}}{T}}$$

Equation 9.4

and assuming $Q=16$ as the detection threshold of modal decay:

$$\alpha_{MODAL} = 1 - e^{-1.1 \times 10^{-3} L_{MODAL} f_{MODAL}}$$

Equation 9.5

where f_{MODAL} corresponds to the centre frequency of the mode in question or, if used more generically, the octave or third-octave band under treatment. It should be noted that this derivation ignores the fact that other surfaces in the room, not providing a reflecting surface for the mode in question, act on the ‘edges’ of the sound wave providing further absorption.

This result provides approximate values that may be used as a guidance in the specific control of problematic modes.

9.5 Implications to room design

The results obtained from this investigation are relevant to applications in room acoustics where the design of efficient control methods should be guided by a deeper understanding of the perceptual and objective factors affecting the reproduction of low frequencies in rooms.

Any informed analysis of modal sound fields has to take into account the temporal response of the room. The sole use of magnitude responses is deficient in revealing the extent of the problems introduced by resonances, and the efficacy or lack thereof of control methods. Power spectral decays are a useful means of representing measured data, as they indicate the frequencies at which the room is responding during its natural response, therefore revealing the most problematic modes and their decay rates.

The definition of a suitable aspect ratio to control the modal distribution of a room is a useful technique to avoid the problem of degeneracy, but is not in itself sufficient and does not certify that the room response will be correct and free from perceptible problems. The reliance on frequency spacing statistics makes this technique weaker when compared to other methods that take into account the temporal characteristics of resonances. If, as is often required, adequate isolation is ensured, problems of resonances should always be expected given the rigid boundaries that are usually specified. These resonances are a physical property of cavities that cannot be avoided, and even ‘optimal’ modal distributions will cause perceptible problems

when musical notes match specific artefacts of the room response. More reliable design approaches should concentrate on construction techniques, where sound isolation is achieved by an outer shell, and the inner shell, constructed from light wall partitions, provides higher levels of damping avoiding very high Q resonances.

Furthermore, the results from this investigation indicate that the temporal response of resonances is an important subjective factor in the detection of the effects of room modes. Given this, and taking into account the large differences between decay rates of a similar bandwidth resonance at two different frequencies, the mere reliance on the modal spacing gives a poor indication of the subjective quality of a room. This is associated with the fact that rooms with more resonances at the lowest audible frequencies will exhibit longer decays than rooms with the same average modal spacing but with less modes at the lower frequency range.

Furthermore, if modal density is increased, the ‘tonal’ effects introduced by resonances may be effectively removed, as the response of the room approaches diffuse field conditions and is no longer dominated by single isolated resonant frequencies. However, if this is achieved without a reduction of the decay rate of the room in this range, the effects of resonances will still be noticeable and will affect the temporal response of transient stimuli.

The control technique of magnitude equalisation is in some ways similar to increasing the modal density as the target condition for both is to achieve less variation in the magnitude frequency response. However, magnitude equalisation introduces important subtleties worth reflecting on.

In any modal sound field, the decay stage is always dominated by the resonant frequencies, and their decay rates will dictate the reverberation conditions of the room at the lower frequencies. If the magnitude of excitation at specific modal frequencies is reduced (magnitude equalisation), the initial perception of the sound field, at the ‘forced’ stage, is improved, as the large variations of amplitude in the frequency response are reduced. When the stimulus is removed, the room responds at its natural frequencies, which decay with specific rates. Nonetheless, at each resonant frequency, the ratio of magnitude between the direct (‘forced’) and decaying (‘natural’) sound fields will be the same for equalised or non-equalised conditions. The perception of resonances will thus be dependent on how much of the decay stage the subject is able to detect – yet again dependence on a temporal aspect.

If a specific resonance is excited at a low level (also possible by careful source positioning), the portion of decay audible in the presence of masking by the continuing musical stimulus may be too short to enable detection. Another important aspect to take into account is the time gap between excitation stimuli, and the masking effect a second stimulus would have on the perception of a decaying resonance from the previous stimulus. If this gap is small, the second

stimulus masks the decay of the first one, but the perceptible distortions imposed on the attack of the sounds will still be noticeable. According to this, magnitude equalisation may achieve some perceptual improvement as it reduces the amplitude level at which each resonance starts its decay cycle. However, the perceptible temporal behaviour of the high Q resonances will always remain and distort the original waveform. Further investigation of the relative merits of shortening the decay time, as opposed to reducing its initial amplitude, is of significant interest.

It follows that any control techniques that are used to further correct the room response should take into account the temporal behaviour of the resonances, given that perception is more closely related to this factor. More specifically, effective control methods should concentrate on the reduction of the Q-factor of the problematic resonances. The results presented here for the difference limen may then be used as guidance to the amount of reduction necessary to achieve a perceptible difference, and economise on either passive absorption material or complexity of active control methods. Furthermore, this type of control not only reduces the decay time of resonances, but also removes the audible amplitude modulation effects. Additionally, the peak level of resonances, inherently related to the Q-factor, will also be reduced. Any overall amplitude variations that may still remain and cause perceptual spectral imbalances may be easily removed using conventional methods, given that the perceptible effects of decay have already been addressed.

As a result, the design of perceptually correct rooms may be improved both in the performance/cost relationship, which will result in more comfortable working environments for audio production, where critical listening decisions may be based on a higher confidence of the perceived sound. The benefits of this will be reflected in the quality of consumer products.

9.6 Further work

Several interesting avenues of further research have been highlighted in the thesis text, and these are collected and expanded upon in the following section.

9.6.1 Linear relationship of difference limen for Q-factor

The determination of additional data points in the difference limen for the Q-factor data as presented in Figure 8.4, could provide further information on the behaviour of the difference limen with absolute Q-factor – the ‘operator-receiver characteristic’. This would be achieved by testing new reference values between the ones already defined. If the same set-up and group of subjects were used, a more powerful statistical analysis may be performed based on the techniques presented in chapter 8. In particular, the hypothesis of linear relationship between Q and its DL might be tested.

9.6.2 Difference limen for Q-factor depending on frequency

As previously discussed, the difference limen for Q-factor of room modes presented in this thesis is a useful ‘tool’ for room designers to decide on target levels to be achieved in the low frequency range. However, the results have been derived for a generic difference limen where all low frequency modes have been assumed to possess the same Q-factor. This assumption was supported by the measurements on which the room models were based, and also by the expectation that in the most general terms, damping is roughly proportional to frequency.

Extrapolations have been derived to indicate difference limen in terms of decay time, but the strong dependence of decay time and centre frequency raised the question of the equivalence of detection in decays across frequency. It is well known that many thresholds in auditory perception vary with frequency and hence it might be expected that other psychoacoustic effects, such as decay detection, might behave similarly.

Recent published work has appeared in this area, concerned with the relative audibility of single resonant artefacts presented individually (Karjalainen et al. 2004), and it may be that there is merit in revisiting these experiments. However, this thesis has pursued ‘room’ simulations as opposed to deconstructing the stimuli into individual modes, and although this deconstruction might be important in gaining a thorough understanding of the mechanics of the percept, the focus on ‘real’ music signals in ‘real’ room conditions is a useful one in obtaining generalisable and applicable data.

To this end, a further experiment may be set-up to extract the difference limen for the Q-factor of room modes, but this time, specific values should be evaluated at different centre frequencies. The same experimental system used in Chapter 8 could be employed, maintaining subjacent experimental principles, such as the use of music samples and representations of real rooms at the ‘high frequencies’. The range of frequencies under test should then be divided into sub-bands. An initial suggestion could be third octave bands in the range 32 Hz to 250 Hz.

The actual construction of the experiment could be achieved in the following way:

- A ‘generic’ small room corresponding to listening standards is used to provide guidance in the density, amplitude and centre frequency of the modes to be used.
- These are divided into third octave band frequency sub-ranges.
- The reductions on the modal Q-factor are exerted at each sub-band keeping all other bands at a fixed reference level.
- This fixed reference level is chosen to correspond to an average condition found in rooms, e.g. $Q=20$.

There are a number of implications from these experimental conditions. Most obvious is the masking effect that the lower frequency sub-bands wield on the higher frequency ones. More specifically, the difference limen determined for the higher (low) frequency sub-bands would be expected to rise due to the masking effects of the lower (low) frequency sub-bands. However, this may be found to be representative of real room applications, if ‘treatment’ is being applied for control within a limited bandwidth. Indeed, this addresses yet another important link between potential results and real applications, as the perceptual effects of narrow band absorption on the modal sound field could also be evaluated.

On the other hand, and as suggested by Karjalainen et al. (2004), it may be that the auditory sensitive to changes in Q-factor is diminished at the very low frequencies as is common for other percepts (e.g. loudness). Indeed, the results from this experiment would thus further indicate how the detection of changes in the decay time of resonances varies with frequency at the lower frequency range.

9.6.3 Comparison of modal equalisation methods

The subjective experimental methods presented in this thesis convey some advantages to subjective testing, as mentioned before. These are the option of direct comparison between auditory conditions and the possibility of generating sound fields that would be problematic to achieve in real rooms. Given this, these methods are powerful to test the theoretical basis of equalisation methods.

One of the most current, and to some extent, still unanswered questions about modal equalisation is the perceived benefit introduced by magnitude equalisation. Indeed, part of this question has been answered in Chapter 7, where the effects of resonances on single tones were tested but maintaining the amplitude of audition constant. It was shown, as expected, that the effects of resonance are still perceived if wide band transient signals are used. However, it would be expected that in the presence of music signals the percept might be altered. Indeed, determination of results for the perceptual factors using music signals is one of the contributions of the work in this thesis. It follows that a test could be defined to determine the perceptibility of magnitude equalisation under critical listening conditions.

The concept is based on previous work by Karjalainen et al. (2004) that suggests the use of an all pass filter with a determined decay rate to represent a magnitude-equalised system that still maintains decay components. Such a system may be obtained with the use of IIR bi-quad filters where the poles and zeros are placed at the same angles and at the same distances from the unit circle. However, the zeros are placed outside the unit circle giving the system non minimum-

phase behaviour. The decay characteristics of the resonances may be determined by varying the vector length from pole and zero to unit circle simultaneously.

The experiment could then be set-up in the following way:

- As in previous experiments, a real room is used as a ‘template’ to provide modal density and centre frequencies of the modes.
- These are modelled using a cascade of bi-quad IIR as used in Chapter 8.
- One or more decay settings are chosen as test factors. The previously determined difference limen is used to select decay times that are perceptually significant.
- The two conditions under test are:
 - A system representing the full room response where the low frequency amplitude variation introduced by the resonances is maintained.
 - A system modelled with the use of various ‘all-pass’ bi-quad filters where the decay characteristics are the same as in the ‘template’ room – this corresponds to the magnitude-equalised system.
- Detection of differences between the two systems is determined (with the option of varying parameters such as modal decay and density).
- Audition samples are normalised to be presented at the same A-weighted level
 - Another factor that could be introduced is the effect of overall level of presentation on the detection of differences. This is highly relevant since in practice a control system will address the level of the stimulus.

Such a test could indicate the perceptible benefits of magnitude equalisation; indeed, the previous values determined for the difference limen for Q-factor could be used to inform the selection of systems which benefit magnitude equalisation, as determined by their overall decay response.

9.6.4 Difference limen for decay rates of single modes

Following the work of Karjalainen et al. (2004), a similar system could be used to extract difference limen for isolated modes in the presence of a room sound field. This is a technique that can provide guidance in target levels for active control systems that operate on single modes. The use of headphone reproduction, rather than a speaker in a real room, is suggested as an improvement to the technique, given that factors such as speaker response or even the

complex interaction between the speaker and the room could be avoided. However, the contribution to a psychoacoustic investigation using results from this method is undermined by the fact that sound fields met in practice, especially in the higher modal frequency range, are not normally subject to carefully controlled modifications to selected solitary resonances.

9.6.5 Quality rating of modal distribution

It has been demonstrated that control techniques that rely on modal distribution to improve the low frequency reproduction on rooms are unpredictable in the amelioration of resonant effects. Such metrics are dependent on frequency domain characteristics, and are highly sensitive to the frequency content of the stimulus.

It should be noted further, that for critical listening environments, techniques relying on frequency response are largely inefficient. However, in less critical listening situations, it is arguable that an increase in modal density may improve the quality of reproduction. It has been mentioned before in this thesis, that if the modal density at the very low frequencies could be drastically increased, the decay would then become more homogeneous across the frequency range, rather than dominated by specific modal frequencies.

A further test could be set-up to identify the difference limen in modal density in order to achieve a perceptible ‘improvement’ in the sound field. It is known that subjective preference tests are difficult to perform, given the often nebulous nature of the parameters under investigation. However, if an improvement in quality of modal decay is defined - for example:

“Do you hear a resonance associated with a ‘boxy’ sound?”

- then a test could be carried out. This could take the following form:

- Using the same magnitude equalised IIR bi-quad system as referred in 9.6.3, a representation of a low frequency sound field is modelled with two widely spaced resonances.
- More resonances are added, with frequencies that correspond to half the difference in frequency between existing ones, until the subject detects an improvement as defined above.
- The decay times of the resonances could be determined according to the difference limen for Q-factor derived before.
 - More than one setting of Q-factor could be tested.
- The modal density and spacing could then be indicated as a quality descriptor.

The results from such an investigation would need careful interpretation, and be used only as an indication of possible improvements in the quality of reproduced sound for non-critical listening environments. Techniques that increase the modal distribution such as the one suggested in 5.3.2 or by Angus (1999 b) could thus be evaluated.

Appendix I Qualitative Study

Presented in the next pages are:

- Initial questionnaire sent by post.
- Interview guide with list of topics to be asked.
- Example of an interview transcription.

Appendix I.i Survey Questionnaire

Bruno Fazenda

Phone: +44 161 295 4172

Fax: +44 161 295 5472

b.m.fazenda@pgr.salford.ac.uk

The purpose of this interview is to identify common terms and preferences used by Technicians, Recording Engineers and Producers involved in professional broadcast, Recording and Post Production when referring to sound in studios.

As a studio user you have preferences and dislikes about your working environment. This interview is going to survey what they are and why.

We are mostly interested in acoustics, however let me stress that you do not need to have any acoustics knowledge. The emphasis is on the experience of your day-to-day working life.

Although the questions may be towards an ideal control room you like, you may refer to control rooms you use or have used in the past.

The interview will be recorded, as this is an easy way to get your responses in full. If you feel we should not record or have any queries please ask.

The following questionnaire asks you some introductory questions. We assure you that all answers will be confidential and that this information will not be accessed by anyone external to the experiment. No studio names or professionals will be mentioned in any publications.

Your participation is greatly appreciated.

Name: _____

How long have you worked in this business?

What types of music do you most usually work with?

Of all the studios you worked at which are your favourites?

If you have any queries could you please contact me as soon as possible at the phone number or email address above.

Thank you for your best attention.

Appendix I.ii Interview Structure

The following is a possible list of base points that should be covered during the interview:

- Reverberance
- Image
- Envelopment
- Loudness
- Clarity
- Frequency Balance
- Spaciousness
- Monitors (sound)
- Mixer/Desk
- Definition
- 'Feeling' of the room
- Acoustic Treatment
- Features of Studio (coffee, pool table, etc)
- Feels like a big/small room
- Can hear acoustics of studio
- Good/Bad Studios

Appendix I.iii Interview transcription

INTERVIEWEE: MG

MG. In terms of reverberance, personally I wouldn't like to... I think the room should be neutral in the sense that you shouldn't be aware of it so if you, if when you're speaking or if when you hear a sharp transient sound you're aware of some kind of reverberance that's created by the room then that's a bad thing I think so yes that would be attitude towards it so in terms of setting you know, I'd say kind of non-existent but it's not very, it's not very helpful to be in a completely dead room like an anechoic chamber, it's not a very helpful environment, it's not very helpful psychologically in that even though in a basic sense you're working and listening to loudspeakers you are conducting conversations with people and you're kind of living out your normal life in the room so you want the atmosphere of that room acoustically to be conducive to well being I suppose and I think a completely dead room is very claustrophobic, I mean this room is slightly too dead I think, I've got to do some work on that and it feels a bit claustrophobic so that's where this question of acoustics cross over into other areas like how you feel, you know, so yes I mean I suppose a very short reverberation but even reverberation in a noticeable sense is probably a bad thing I would have thought, you don't really want to hear anything at all but you need to have something that gives you, you need some reflections so that it feels natural but that's about as much as possible, as much as should be allowed.

B. OK, right, we'll jump on to stereo image and your definition of a good stereo image.

MG. Good stereo image, well I guess it's down to accuracy, you need to perceive the qualitative sound from each speaker, if we're just talking about a two speaker system as opposed to 5.1, you need to make sure the sound from each speaker is the same, perceptively the same, so it needs to be balanced but also I suppose yes, you need clarity, you need to feel that when you place a mono source in the centre, if you're doing a multi-track mix and you place your mono source in the centre, which is a phantom centre, then that needs to feel like it's a very narrow, well defined point that the source is coming from because mono is a point source so shouldn't sound like, it shouldn't appear that that sound is spread in any way either side of that central position so you need to, I suppose I'm adopting a sort of laboratory attitude towards it really, you need to feel you can hear clearly every single definable point between the two speakers so that means you need to whatever you need to do to create that...

B. Defined panning positions.

MG. Yes, I think so, defined imagery yes, so that if you've got a series of images in a stereo field then they're clearly defined, discernable.

B. OK, and that stereo field that you just mentioned, would you prefer it to be sort of within the speaker angle or would you aim for something that is wider than the speaker angle.

MG. Oh no, if it's wider than the speaker angle that implies to me, if it's created by the room then there's some reflecting going on which is creating an artificial sense of what's actually happening between the speakers.

B. OK.

MG. I mean I know everyone listens to stereo at home and it's going to be messed up at home anyway, I think you need to think well nothing should exist beyond the speakers.

B. OK.

MG. Because nothing's being created beyond the speakers.

B. Right.

MG. Unless it's being created artificially by the room or by some kind of phase effect which you do deliberately but you know, sure if you're not intending to that then it should be limited by the speaker.

B. OK, very good, this next question sort of catches up or you know picks up on these last words you said, in terms of the sound itself, do you, when you're doing you know your work, professional work obviously, not for pleasure listening but for work, do you like to be surrounded by the sound or not?

MG. No, again if it's a stereo operation then you certainly shouldn't be surrounded by the sound, I mean obviously 5.1 surround sound, that's a different thing entirely but again it would seem me that if the sound, in a stereo situation if the sound appeared to be coming from somewhere else then that would be a problem in the room I think.

B. Right.

MG. It's going to be a big, because of reflections.

B. So, you would go, your preference, your opinion is to go for a focused sound.

MG. Oh yes.

B. On the speaker ...

MG. Absolutely yes.

B. OK, if I can sort of bring you back to some of the studios where you worked, what are the sort of memories of how the sound varies in those rooms or you know in main big control rooms, around different positions if you see what I mean.

MG. As you move around the control room?

B. Yes.

MG. Well to be honest I haven't spent a lot of time studying that because although it is important to know how the sound changes when you move from the front to the back or the back to the front, but I suppose I tend to, I will always just sit here in front of the speakers at the triangular axis and so I tend to just concentrate on what it sounds like there so, but I usually find most control rooms sound, if you stand at the back of the room there's a lot more bass but there's the reasons for that and that's just something I accept, I suppose I'm not really aware of how the rooms have changed as you move around them that much.

B. But were you aware at all that that rooms have different sort of sound positions.

MG. Oh yes, sure.

B. Different sound in different positions, you aware of that.

MG. Yes, yes.

B. And what's your opinion on that, should that exist or...

MG. Well it'd be nice if it didn't but I think it's maybe secondary to, well it's something that you have to, you have to try and achieve but I think it's perhaps rather difficult to do that as well as to get a very good result if you're sitting there, I think maybe you know in terms of control room design this is, you should aim for a good sound when you're sitting in this position here in front of the speakers and if you can make it sound as good everywhere else then fine but I think that's the most important thing.

B. So that would be more important than sounding, so in other words making a compromise between having the sound sort of very good or good around the room between that and having a very good sound at one position and a bad sound somewhere else, you would go for the good sound at the listening point?

MG. I think so yes really

B. Yes.

MG. Because it is a working environment again, it's not a playback environment.

B. That's right.

MG. Although sometimes it is but yes if there had to be a compromise, well no I wouldn't want to compromise the quality there.

B. OK.

MG. Certainly, in front of the...

B. You know, still on this question, yesterday I've been in a studio where they had a you know, I think it was an SSL 9000, huge mixing desk and obviously you know people were saying you don't get the same sound across all channels.

MG. Sure.

B. And if you were working at one end and you've got a bass problem and then you come to the middle and the bass changes now if we look at that situation then obviously you know an engineer, a producer needs to move around, up and down the

mixing desk, what would then be your preference, again with the same question, would you compromise the central position to get larger area or would you have a fixed point where you'd go and reference?

MG. Well I think probably I'd still have a fixed point because the thing is with a console as big as a 9000 or even a G series SSL or a Neve it's always going to be a problem because, well for me and I think for a lot of people most of the time we listen to the near field monitors and most of the time we're making, we're listening to near field monitors, NS10s, at this distance and when they're positioned like that, when you go to the other end of the 9000 you're completely out of the spectrum of the speakers, I mean it's impossible to get a good sound when you're standing over there, the sound's just going past you so in that case whatever you do to the room you will have to come back to this point to make a decision about what you do over there so I wouldn't want to compromise this point for that situation.

B. OK, tonal balance, by that I mean frequency sort of response, you know that's a more technical term, I don't want to get a lot of technical terms into this, but how would you describe, how would you classify a proper room, a good room in terms of tonal balance?

MG. Well that's kind of difficult, for a start it's very subjective anyway, I mean this is a very, I mean the number of times I've got into this sort of conversation about monitors, it's really, because well first of all you can't separate the acoustics design of the room from the monitors so that's a very big important thing I think that needs to be said and a lot of people don't think like that, they seem to think that the room is one thing and then you put your monitors in the room and that's it, you know, the room is supposed to respond to the monitors but they've got to be designed together I think, that's an important thing but anyway this questions of the way it sounds, I mean the obvious sort of simple answer is that it should sound flat and even and so that technically leads you to measuring the response so that it's the same at all frequencies but I know that with, when I've been involved with the design of studios like the Town House and the Manor with Tom Hidley's designs we found that if the high frequency response was allowed to be flat up to 18 or 20 kHz that it produced a sound which was, although it technically measured as being flat it wasn't conducive to good working results because we found that we would, the recordings when they were played somewhere else sounded like they didn't have enough high frequencies so it was decided that it was better if the high frequency response was rolled off from, so it was decided to roll of the high frequency response, I think it was 1 dB down at 16K and 2 dBs down at 12K, I can't remember exactly but that way we found that then we added more high frequencies to the recordings and they sounded better when played in other environments so that's the kind of, that's an example of how it isn't necessary, it isn't appropriate for the response to be flat.

B. OK.

MG. So beyond that I get very subjective about what I want to hear you know because there's the thing about, a recording control room is not really a listening environment, it's a working environment, I think you're aware of that anyway but and so the criteria are different, you need to hear a sound which is conducive to the work you do, if that's understandable, and that's not always a flat, uncoloured sound, it's something which helps you to create a good recording, whatever that is.

B. OK, that is quite understandable.

MG. I mean I think a lot of people don't think, I mean personally, that's one reason why I don't really like Genelec loudspeakers, for me Genelecs are, although I've heard them sounding good in some rooms, they sound good in Olympic, they sound good at Town House 4, but generally to me they're good listening speakers but they're not so good working speakers, I like Quedsted speakers because they may not sound flat, whatever that means but I like the sound of them and I've found that I work in a certain way because of the way they sound so you know but, so flatness is not a, not necessarily appropriate.

B. OK.

MG. But I don't really know how to describe what's appropriate you know, it is very subjective.

B. Do you recall working in control rooms and finding, or feeling that the sound was frequency heavy at some band?

MG. Oh yes sure.

B. Even at the listening position?

MG. Yes, oh yes.

B. And what sort of things were you finding that, more bassy or more...

MG. All kinds of things.

B. All kinds?

MG. Too dull, too bassy, strange resonances I mean phase problems where you could hear that something was happening in the room which caused a strange effect in the lower-mid range.

B. Yes, what?

MG. I would usually assume that to be reflections in the room so.

B. But how would you sort of put into words that effect, what was happening?

MG. How it sounded?

B. Yes.

MG. Well usually, I mean this room for example which is not very acoustically treated, it's a very small amount of acoustic treatment and the walls are parallel, there are lots of peaks and you notice it particularly in the lower mid, anything between 800 Hz down to about 200 Hz, there are lots of peaks in the response and there are lots of resonances, you might be listening to a certain instrument and it'll have a cloudiness in the sound because you can hear that it's resonating in the room, there's a kind of humming effect you know when the musician plays a certain note on the instrument and that's a very strong coloration, it's because of standing waves and reflections and all the stuff that happens when you work in a room that's not really treated very well.

B. Were you find these happening at you know a localised position like the listening position or other?

MG. Well this is a good room to use as a demonstration because you get those effects all over this room you know, it depends where you sit, it changes just moving six inches or a foot you know because as the reflections change you know, they hit you in different ways.

B. During the time you've been working you know using control rooms for recording, for mixing, producing, have you found that you were getting used to how a certain control room sounded?

MG. Yes, certainly, I mean I think wherever you go, if you go to a new room that you're not familiar with even if it sounds really good, you do have to get used to it and it can take a couple of days to really get used to it, some rooms I find that I can never get used to, well not never, you can never say never but it takes a long time because there'll be a problem in that room which is just, you're always aware of and it's disturbing and it's so disturbing that it's always a problem.

B. What sorts of problems may we, talking about?

MG. Same kind of thing, it's usually resonances between the surfaces.

B. Resonances, coloration.

MG. Yes, I mean there's one control room I've worked at where the, behind the desk there was the window into the studio and it was very close to the back of the NS10s, well maybe this distance, 4 feet and there was a reflection from the back of the NS10s to the window and back towards the listening position and they were aware of it in the studio and eventually they found a very big piece of thick foam and put it across the back and that helped but it was again it was reflections, same sort of problem as everywhere else.

B. In the ones you sort of became accustomed to, used to, how would you describe that, the learning process, if you can put it into words, what would sort of, I mean, I'm trying to, I'm aiming my question to were you sort of understanding that that room, little sort of characteristics that were imposed onto the sound and you were sort of compensating.

MG. Well that's pretty much it yes, you, yes you begin to recognise, I mean the first thing you do is to play a reference tape, a tape of mixes or music that you're familiar with and you know what it's supposed to sound like or you know what you're familiar with and so immediately you hear something strange like too much treble or a resonance at 1 kHz or too much bass or a fuzziness in the stereo image or something like that, so you hear that straight away and so you make a note of that and then you start to work and you notice other things as you start to equalise an instrumental or whatever and so the first thing you do is to learn about the room is to recognise those characteristics and yes make allowances for them, I guess, you hear, say there's too much bass then when you're working on the low frequencies you have to remember there's too much bass but what kind of bass, is it 200 Hz or is it 80 Hz or so you have to be aware of that so you think OK, you make decisions based on that and you have to play your results, you have to play your work in other environments to check that it's OK but the getting used to it is really a question of acceptance I think really, you do, you get to the stage where you don't have to think about those characteristics, it's a question of confidence as well, I think you, by playing the work on another system, if it sounds acceptable then accept the room and you become familiar with it and you accept that your work will be alright, that's the main thing is that your work may be different from what you did in another control room but it's still OK so it's a question of confidence, it's a gradual acceptance of those characteristics.

B. We can I mean the system you use to monitor your work, other recording, I don't know how much you work in this room and how much you work in other rooms, obviously in the past you've worked a lot in other places, do you find that these systems were being faithful to either what was being recorded onto the tape or either what was on the tape, you know, by asking this I'm trying to ask, do you know, were you sure you were hearing what was being recorded or monitoring from the tape?

MG. Pretty much yes, well you're never 100 percent sure because there's no absolute right thing anyway, but yes I guess the studios that I liked working in I would feel confident about the sound.

B. Which are the ones I'm looking at now.

MG. The ones down there yes.

B. So that, I mean they would be faithful to what was being monitored?

MG. Yes I think so, yes.

B. You've mentioned this but I'll ask you, you know a bit more in depth about the way you compare your final work on other systems so you say you take it outside and if it sounds good you know you've done a good work, now where do you listen to it and what sorts of things do you look for when you listen to it on other systems?

MG. I would listen to it at home and...

B. At home you mean a hi-fi system.

MG. Yes, a very basic hi-fi system, I mean because for me there are a number of things I listen to, one is the kind of what I'd call the technical frequency bands which is just how much bass, how much treble but then the other more musical aspect is the question of the musical aspect of a mix for example, the balance of the instruments and the perspective of the instruments, reverberation is important as well, and so I guess in order to understand the technical balance I'd need, I'd would play it probably in another control room, another studio or even a hi-fi system in the recording studio where I was working, in the next room perhaps or in an office or something that had a reasonable frequency range.

B. Right.

MG. Yes, I mean, wherever is available, if I'm mixing in Germany or somewhere and I don't know where else I can play the thing then I've got to, I've just got to find whatever I can, another system somewhere you know so I just have to look around and ask them what they've got so you have to kind of go with whatever's there.

B. And you do rely on that comparison, you find that it is important.

MG. Oh it is important.

B. To go and check.

MG. Certainly, yes, yes, you definitely have to go and check, yes.

B. How happy have you been with you know the thing you bring out and then you listen you know, I'm trying to sort of aim at do you ever recall having to go back, working at a certain studio, having to go back compensating for the same thing over and over, you know not on the same mix but let's say you were doing five songs and every song you were going back to the room and adding say a bit more mid because it was not there.

MG. Well it's the kind of thing that, you would learn that on the first mix.

B. Right.

MG. But then you would, you would hope your work would change to compensate for that and you'd listen to the same mix and see did it have the same problem, if not then you know so that's part of the learning thing is to recognise that problem, yes I mean I think it's part of the job to be able to deal with those situations I suppose, I mean unless the control room is so bad that every mix sounds terrible then you have to work somewhere else.

B. Right.

MG. But I think in general most control rooms can compensate to a certain extent, there's always a bit of a safety net in that when you're mastering you can make some little changes as well so.

B. OK.

MG. If there's a little bit too much bass then you can, hopefully you can fix that when it's mastered.

B. Good, near field monitors and main field monitors, you did mention you use them, now what, if you can put it in a percentage, how much do you do on near field and how much do you do on main monitors and the reasons.

MG. At least 80 percent on near fields.

B. Near fields, so most of the work, yes.

MG. Most of the time and I think the reasons, well main monitors are just, the sound it's just too big to listen to all the time, it's somehow unrealistic I guess you know I find it difficult to make decisions about the balance of instruments on big speakers, it sounds too good, it sounds too big but you need to, you need big speakers in order to really get an idea of what's happening in the lower frequencies because you can't do that on near fields but I find it's much more valuable to listen to near field monitors fairly loud but certainly I just find it easier and more realistic, I get again results that sound good on other systems, I get better results if I listen on near fields.

B. OK, so that's, you basically saying main monitors will give you a sort of a picture of what's going on on the lower frequencies.

MG. Yes.

B. So you refer to them just to sort of monitor low frequencies.

MG. Pretty much actually yes.

B. And the rest.

MG. Although, but having said that I mean that's partly because with the variation in rooms and the variations in monitors there is a much bigger variation between if you go from one room to another room to another room, there's a much bigger variation in the big monitors, the main monitors than there is in the near fields, especially if you use NS10s, if you use NS10s and a quad amplifier or a good amplifier whatever then it doesn't sound that different in a different studio, I mean it will sound different certainly but the differences are not so disturbing so at least the near fields give you a greater consistency between studios so that's another big reason.

B. OK, and to wrap up, the final question and the sort of more difficult one according to people answering to it, how would you describe the sound of an optimum control room?

MG. How would I describe it?

B. Yes, in your own words.

MG. Well it would have to, it needs to sound natural, it needs to sound like you're not aware of the room, the acoustics of the room at all so that you feel like you're just listening to the music that's coming out of the speakers so yes I wouldn't want to hear any resonances or, a clear stereo image, well balanced across the room if possible, if it

was possible for it to sound exactly the same everywhere in the room that would be really good, it needs to be a sound that's not tiring as well, there are some monitors when you listen to them for a long time you get very tired, they're kind of, they're very hard to listen to so it should be a comfortable sound but transparent, yes transparent and without any real character, I think just something that's, to me it's just a tool that you listen through and you don't really want to be listening to the monitors you want to listen to the music.

B. Right.

MG. You were saying before about other factors that affect control rooms, I think there are other factors that affect control rooms and the way you feel, I mean one thing is daylight, I think it's nice to have daylight, I feel this room is quite claustrophobic because it's you know no windows and that has a bearing on sound design because well for a start there's the reflection from the glass which makes a difference and also the questions of keeping out the sound from outside, soundproofing is difficult with windows but I think it's important if you can to have some daylight, size is important as well I mean it's good to have perhaps 50 percent bigger than this would be a nice size and the size of the room has a big effect on the design of the acoustics, what else, I guess that's it yes.

B. Very good.

MG. OK.

B. That's great.

MG. Alright then.

B. Thank you very much.

Appendix II Room measurements

Appendix II.i Steady state modal sound field

Low frequency sound field measurements were obtained using a dual FFT analyser as described by the following figure.

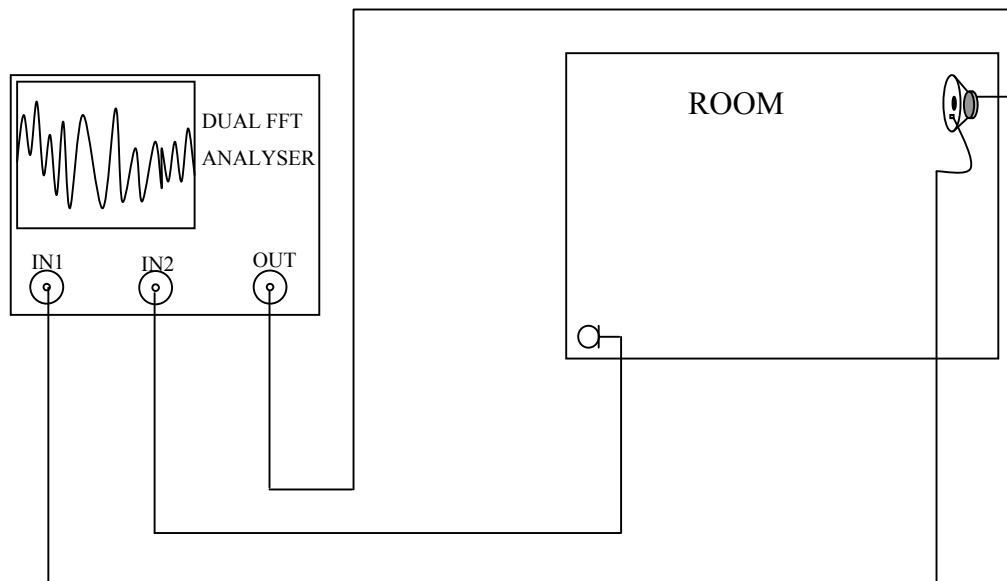

Pink noise was generated at the analyser and reproduced in the room using a large diaphragm loudspeaker in a closed box, which was placed in one of the room corners. Using this method, the steady state response of the room is obtained. The accelerometer attached to the cone of the loudspeaker provides a measure of cone velocity. This signal was then compared to the signal picked up at the microphone placed in the opposite corner. The complex transfer function in the room was then obtained.

The dual FFT system provides 400 data points in the selected range. These could be 100 Hz, 200 Hz, 500 Hz and higher. Measurements up to 100 Hz were used to compare with data in Chapter 3.

Appendix II.ii Reverberation time

The reverberation time in the rooms was measured using a proprietary measuring system based on maximum length sequences – MLSSA. A large loudspeaker was placed in one of the room corners, in order to ensure that all modes in the sound field are excited.

In order to obtain a good signal to noise ratio, the measurement system had to be set-up to maximum capabilities. The acquisition word length was set to maximum number of points – 65535. Additionally the pre-averaging settings were defined at maximum – 16. This sets the system to obtain multiple measurements and use average techniques to increase the signal to noise capabilities. Due to the long word lengths, and large number of averages, each measurement would last around 30 minutes. The reverberation time at each position is obtained from the Schroeder plots. The correlation coefficients of the measured data used were all above the 0.98 minimum level.

Measurements were taken at various microphone positions in the room, usually in an area defined as the listening area of the room being measured. The final reverberation times shown in the main text correspond to the arithmetic averages of the various measurement positions.

Appendix III Distributed Source Derivations

Appendix III.i Derivation for source shape function for a rectangular piston – front radiation only

The rectangular piston is physically defined using room coordinates that represent its edges in each dimension. The x_0 coordinate defines the distance to the parallel wall just behind it. In the model $x_0=0$, hence the plate is defined at the room boundary.

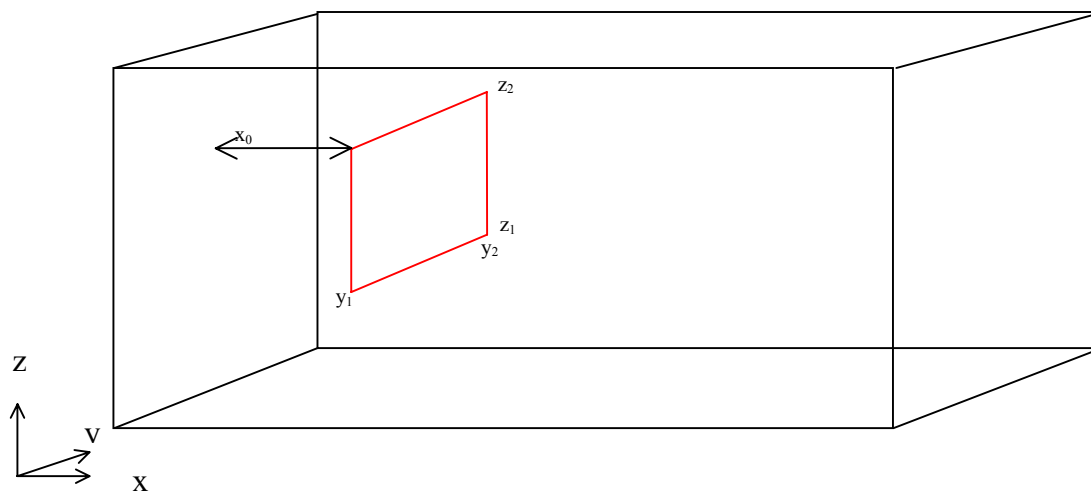

Appendix Figure 1– Definition of plate boundaries in the room.

The plate is defined as a delta function in the x dimension and 1 in the other two dimensions. The following integral gives the rectangular piston source shape function:

$$\int_{z_1}^{z_2} \int_{y_1}^{y_2} \int_{x_1}^{x_2} \delta(x - x_0) |1 \cos(k_{n_x}) \cos(k_{n_y}) \cos(k_{n_z})| dx dy dz$$

Appendix Equation 1

where k_n corresponds to the room wave number in each of the room dimensions.

The solution:

$$\int_{z_1}^{z_2} \int_{y_1}^{y_2} \int_{x_1}^{x_2} \delta(x - x_0) \cos(k_{n_x} x) \cos(k_{n_y} y) \cos(k_{n_z} z) dx dy dz \Rightarrow$$

$$\cos(k_{n_x} x_0) \int_{z_1}^{z_2} \int_{y_1}^{y_2} \cos(k_{n_y} y) \cos(k_{n_z} z) dy dz \Rightarrow$$

$$\cos(k_{n_x} x_0) \int_{z_1}^{z_2} \left[\frac{\sin(k_{n_y} y)}{k_{n_y}} \right]_{y_1}^{y_2} \cos(k_{n_z} z) dz \Rightarrow$$

$$\cos(k_{n_x} x_0) \int_{z_1}^{z_2} \underbrace{\left[\frac{1}{k_{n_y}} (\sin(k_{n_y} y_2) - \sin(k_{n_y} y_1)) \right]}_{\text{independent of } z} \cos(k_{n_z} z) dz \Rightarrow$$

$$\cos(k_{n_x} x_0) \frac{1}{k_{n_y}} (\sin(k_{n_y} y_2) - \sin(k_{n_y} y_1)) \frac{1}{k_{n_z}} (\sin(k_{n_z} z_2) - \sin(k_{n_z} z_1)) \Rightarrow$$

$$\therefore \Psi_{PistonPlate} = \frac{1}{k_{n_y} k_{n_z}} \cos(k_{n_x} x_0) (\sin(k_{n_y} y_2) - \sin(k_{n_y} y_1)) (\sin(k_{n_z} z_2) - \sin(k_{n_z} z_1))$$

Appendix Equation 2

But this expression has singularities when:

$$k_{n_y} = 0 \quad \text{or} \quad k_{n_z} = 0$$

So to solve this, the cases where either or both of the room wave numbers are zero need to be investigated.

If one of the k_n is zero, the original expression is changed to:

$$\int_{z_1}^{z_2} \int_{y_1}^{y_2} \int_{x_1}^{x_2} \delta(x - x_0) \cos(k_{n_x} x) \underbrace{\cos(0)}_{=1} \cos(k_{n_z} z) dx dy dz$$

and the integral reduces to:

$$\cos(k_{n_x} x_0) [y_2 - y_1] \int_{z_1}^{z_2} \cos(k_{n_z} z) dz \Rightarrow$$

$$\cos(k_{n_x} x_0) [y_2 - y_1] \frac{1}{k_{n_z}} [\sin(k_{n_z} z_2) - \sin(k_{n_z} z_1)]$$

Appendix Equation 3

for $k_{n_y} = 0$ and $k_{n_z} \neq 0$

the inverse situation for $k_{n_y} \neq 0$ and $k_{n_z} = 0$ is obtained by swapping z with y in Appendix Equation 3

If both z and y dimension wave numbers are zero, Appendix Equation 1 transforms into:

$$\int_{z_1}^{z_2} \int_{y_1}^{y_2} \int_{x_1}^{x_2} \delta(x - x_0) \cos(k_{n_x} x) dx dy dz \Rightarrow$$

$$\cos(k_{n_x} x_0) [y_2 - y_1] [z_2 - z_1]$$

Appendix Equation 4

For $k_{n_y} = 0$ and $k_{n_z} = 0$.

Appendix III.ii Coefficients in frequency equation for distributed plates

From Warburton (1954). The z dependencies are obtained by substituting x by z.

Boundary Condition	n_x	G_x	H_x	J_x
Simply Supported	2,3,4...	$n_x - 1$	$(n_x - 1)^2$	$(n_x - 1)^2$
Fixed	2	1.506	1.248	1.248
	3,4,5...	$n_x - \frac{1}{2}$	$\left(n_x - \frac{1}{2}\right)^2 \left[1 - \frac{2}{\left(n_x - \frac{1}{2}\right)\pi}\right]$	$\left(n_x - \frac{1}{2}\right)^2 \left[1 - \frac{2}{\left(n_x - \frac{1}{2}\right)\pi}\right]$
Free	0	0	0	0
	1	0	0	$\frac{12}{\pi^2}$
	2	1.506	1.248	5.017
	3,4,5...	$n_x - \frac{1}{2}$	$\left(n_x - \frac{1}{2}\right)^2 \left[1 - \frac{6}{\left(n_x - \frac{1}{2}\right)\pi}\right]$	$\left(n_x - \frac{1}{2}\right)^2 \left[1 - \frac{6}{\left(n_x - \frac{1}{2}\right)\pi}\right]$

Appendix III.iii Derivation for source shape function for a simply supported plate – front radiation only

The full derivations for the source shape function for a simply supported plate in an enclosed rectangular space are indicated. This material is presented in hand written format.

①

$$\int \int \int_{z, y, x} \delta(x-x_0) \sin(p_y y_p) \sin(p_z z_p) \sin(p_x x_p) \cos(R_x x) \cos(R_y y) \cos(R_z z) dx dy dz$$

$$\sin(p_y y_p) \sin(p_z z_p) \cos(R_x x_0) \int \int \sin(p_y y_p) \cos(R_y y) \sin(p_z z_p) \cos(R_z z) dy dz$$

\uparrow position of excites in room \uparrow position of plate \uparrow points in the plate

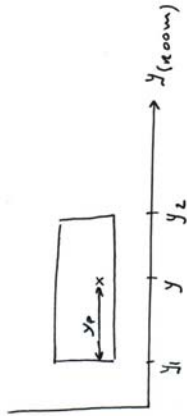

$y = y_1 + y_p \Rightarrow y_p = y - y_1$
the same happens for z_p

So lets solve this for the y case, and we now a similar result is for z .

So we have:

$$\int_{y_1}^{y_2} \sin p(y-y_1) \cos(R_y y) dy = \int_{y_1}^{y_2} [\sin p y \cos p y_1 - \cos p y \sin p y_1] \cos(R_y y) dy =$$

$$= \int_{y_1}^{y_2} \sin(p y) \cos(p y_1) \cos(R_y y) dy - \int_{y_1}^{y_2} \cos(p y) \sin(p y_1) \cos(R_y y) dy$$

Functions of y $f(y)$

$$= \cos(p y_1) \int_{y_1}^{y_2} \sin(p y) \cos(R_y y) dy - \sin(p y_1) \int_{y_1}^{y_2} \cos(p y) \cos(R_y y) dy$$

18.02.02

2

Lets Solve the first integral $\int_{y_1}^{y_2} \sin(py) \cos(Ry) dy$

$$\sin A \cos B + \cos A \sin B = \sin(A+B)$$

$$\sin A \cos B - \cos A \sin B = \sin(A-B)$$

$$\text{So } \frac{1}{2} \int_{y_1}^{y_2} \sin(py) \cos(Ry) dy = \frac{1}{2} \left[\int_{y_1}^{y_2} \sin(p+R)y dy + \int_{y_1}^{y_2} \sin(p-R)y dy \right]$$

$$\text{a) } \int_{y_1}^{y_2} \sin(p+R)y dy = -\frac{1}{p+R} \left[\cos(p+R)y \right]_{y_1}^{y_2} = -\frac{1}{p+R} \left[\underbrace{\cos(p+R)y_2 - \cos(p+R)y_1}_A \right] \Rightarrow -\left[\frac{1}{p+R} A + \frac{1}{p-R} B \right] \Rightarrow$$

$$\text{b) } \int_{y_1}^{y_2} \sin(p-R)y dy = -\frac{1}{p-R} \left[\cos(p-R)y \right]_{y_1}^{y_2} = -\frac{1}{p-R} \left[\underbrace{\cos(p-R)y_2 - \cos(p-R)y_1}_B \right]$$

$$\Rightarrow - \left[\frac{(p-R)A + (p+R)B}{p^2 - R^2} \right] = - \left[\frac{A(p-R) + B(p+R)}{p^2 - R^2} \right] = - \frac{p[A+B] + R[B-A]}{p^2 - R^2}$$

$$A = \cos Py_2 \cos Ry_2 - \sin Py_2 \sin Ry_2 - \cos Py_1 \cos Ry_1 + \sin Py_1 \sin Ry_1$$

$$B = \cos Py_2 \cos Ry_2 + \sin Py_2 \sin Ry_2 - \cos Py_1 \cos Ry_1 - \sin Py_1 \sin Ry_1$$

these cancel with the 1/2

$$\text{So back to previous: } - \frac{p(2 \cos Py_2 \cos Ry_2 - 2 \cos Py_1 \cos Ry_1) + R(2 \sin Py_2 \sin Ry_2 - 2 \sin Py_1 \sin Ry_1)}{p^2 - R^2}$$

$$\text{So } \int_{y_1}^{y_2} \sin(py) \cos(Ry) dy = -\frac{1}{p^2 - R^2} \left[p(\cos Py_2 \cos Ry_2 - \cos Py_1 \cos Ry_1) + R(\sin Py_2 \sin Ry_2 - \sin Py_1 \sin Ry_1) \right]$$

And now the second integral $\int_{y_1}^{y_2} \cos(Py) \cos(Ry) dy$

$$\begin{aligned} \cos A \cos B - \sin A \sin B &= \cos(A+B) \\ \cos A \cos B + \sin A \sin B &= \cos(A-B) \end{aligned} \quad (3)$$

$$\text{So } \frac{1}{2} \int_{y_1}^{y_2} \cos(Py) \cos(Ry) dy = \frac{1}{2} \left[\int_{y_1}^{y_2} \cos(P+R)y dy + \int_{y_1}^{y_2} \cos(P-R)y dy \right]$$

$$\begin{aligned} \text{a) } \int_{y_1}^{y_2} \cos(P+R)y dy &= \frac{1}{P+R} \left[\sin(P+R)y \right]_{y_1}^{y_2} = \frac{1}{P+R} \left[\underbrace{\sin(P+R)y_2 - \sin(P+R)y_1}_A \right] \\ \text{b) } \int_{y_1}^{y_2} \cos(P-R)y dy &= \frac{1}{P-R} \left[\sin(P-R)y \right]_{y_1}^{y_2} = \frac{1}{P-R} \left[\underbrace{\sin(P-R)y_2 - \sin(P-R)y_1}_B \right] \end{aligned} \Rightarrow \frac{1}{P+R} A + \frac{1}{P-R} B$$

$$\Rightarrow \frac{(P-R)A + (P+R)B}{P^2 - R^2} = \frac{AP - AR + BP + BR}{P^2 - R^2} = \frac{P(A+B) + R(B-A)}{P^2 - R^2}$$

$$A = \sin Py_2 \cos Ry_2 + \cos Py_2 \sin Ry_2 - \sin Py_1 \cos Ry_1 - \cos Py_1 \sin Ry_1$$

$$B = \sin Py_2 \cos Ry_2 - \cos Py_2 \sin Ry_2 - \sin Py_1 \cos Ry_1 + \cos Py_1 \sin Ry_1$$

$$\text{So we have } \frac{P \left(\cancel{\sin Py_2 \cos Ry_2} - \cancel{\cos Py_2 \sin Ry_2} + \cancel{\sin Py_1 \cos Ry_1} \right) + R \left(-\cancel{\cos Py_2 \sin Ry_2} + \cancel{\sin Py_1 \cos Ry_1} \right)}{P^2 - R^2}$$

$$\int_{y_1}^{y_2} \cos(Py) \cos(Ry) dy = \frac{1}{P^2 - R^2} \left[P \left(\sin Py_2 \cos Ry_2 - \sin Py_1 \cos Ry_1 \right) + R \left(\cos Py_1 \sin Ry_1 - \cos Py_2 \sin Ry_2 \right) \right]$$

So, now we have the solutions to the integrals, we can reconstruct the big expression: ④

$$\text{First: } \cos(p_y) \left(-\frac{1}{p_z^2 - R_z^2} \right) A - \sin(p_y) \left(\frac{1}{p_z^2 - R_z^2} \right) B = \left(-\frac{1}{p_z^2 - R_z^2} \right) \left[\cos(p_y) A_y + \sin(p_y) B_y \right]$$

Now we can use analogy to solve the integral for the z dimension in the room.

Finally, we get:

$$\psi_{\text{source}}^{(2)} = \sum_{\text{plate}} f(w) p \sin(p_y y_0) \sin(p_z z_0) \cos(R_x x_0) \left(-\frac{1}{p_z^2 - R_z^2} \right) \left[\cos(p_y y_1) A_y + \sin(p_y y_1) B_y \right] \left(-\frac{1}{p_z^2 - R_z^2} \right) \left[\cos(p_z z_1) A_z + \sin(p_z z_1) B_z \right]$$

\leftarrow mode on plate

$P_y = \frac{m_y \pi}{l_y} \leftarrow$ y dimension of plate ; $R_y = \frac{m_y \pi}{L_y} \leftarrow$ y dimension of room

$y_0, z_0 \rightarrow$ Exciter location in the plate 

$x_0 \rightarrow$ Distance from plate to parallel wall in room 

$y_1, z_1 \rightarrow$ y boundaries of plate in room 

$$A_y = \sqrt{P_y} \left[\cos(p_y y_2) \cos(R_y y_2) - \cos(p_y y_1) \cos(R_y y_1) \right] + R_y \left[\sin(p_y y_2) \sin(R_y y_2) - \sin(p_y y_1) \sin(R_y y_1) \right]$$

$$B_y = \sqrt{P_y} \left[\sin(p_y y_2) \cos(R_y y_2) - \sin(p_y y_1) \cos(R_y y_1) \right] + R_y \left[\cos(p_y y_1) \sin(R_y y_1) - \cos(p_y y_2) \sin(R_y y_2) \right]$$

Appendix IV Statistics

The analysis of data gathered during the subjective tests has been carried out using common statistical methods. In order to use these methods, some assumptions are necessary. This appendix explains these assumptions and the implications of the methods.

Initial analysis of data extracts parameters that describe main features of the data. Common descriptive parameters are *means* and *variances*. The meaning of these descriptors is well known and explained in statistics textbooks. These parameters are sensitive to the distribution of the data, and in most cases, rely on the assumption that data is normally distributed. This concept will be explained further.

Appendix IV.i Null hypothesis and significant levels

In order to verify if differences obtained in data show a genuine experimental effect or should otherwise be discarded as a likely representation of chance fluctuations, *tests of significance* are used.

Decision for significance involves rejecting or retaining a null hypothesis (H_0). A null hypothesis claims that two or more obtained conditions or results are identical or were achieved by chance alone.

The statistical methods used in this thesis determine a probability for the null hypothesis. If the probability for H_0 is low, then it is rejected and an alternative hypothesis H_1 is accepted. A p (probability) value under 5% is accepted in science as statistically *significant*, that is, the results obtained may be recognized as a consequence of the experimental procedure rather than some random effect. If the value is above 5%, H_0 is accepted as true, that is, the results are *not statistically significant* and could have been obtained by chance. Sometimes the p value may be under 1%, in which case the result is commonly interpreted as *highly significant*. Such levels of significance are usually required if the hypothesis tested is controversial, in order to provide higher levels of confidence to reject the null hypothesis and accept the occurrence of a genuine effect.

Appendix IV.ii Chi-Square tests

A *chi-square* test is used to test for differences between two conditions. In the case of this thesis, these tests are used to check if subjects were able to detect a difference between two audition samples. The two distributions involved are: the number of correct responses for each subject; and the number of correct responses that a subject is expected to achieve if s/he is answering at random. The use of chi-square tests does not require the assumption of normal distribution for the data.

The null hypothesis (H_0), in this case, states that the result obtained for each individual test is no different from that if the subject answered randomly. The obtained value for p from a Chi-square test indicates the probability of H_0 being true. This probability value is calculated by comparing a subject's result to that expected if the subject was answering randomly. For the cases tested, under the null hypothesis, it was considered that a subject would get half the number of trials correct.

The determination of a chi-square value is obtained by calculating the difference between the number of correct responses to the number of expected response under H_0 .

$$\chi^2 = \sum \frac{(\text{correct} - \text{expected})^2}{\text{expected}}$$

Chi-square tests are only valid when data are frequencies rather than means or ratios, which makes them suitable in the case of repetition tests for a single or a group of subjects in task of difference detection.

Appendix IV.iii Normal distribution

Normal distributions of data are common when very large samples of a given population are recorded. Characteristic of a normal distribution are that data is continuous, symmetrical about its mid-point and when plotted forms a 'bell-shape'. As the sample size is reduced, the distribution of data may begin to differ from normal distributions.

Most methods of descriptive analysis are based on the assumption that the sample of data was drawn from a normally distributed population. This concept is important, as most of the more powerful methods of analysis, and in particular the analysis of variance, assume this to be true. These methods are called *parametric* because they are

based on parameters that describe the population, such as *mean* and *variance* that rely on normal distributions. If the gathered data is not normally distributed, the parameter values are too sensitive to extreme data values and provide less accurate estimates of the population.

In this thesis, before deciding on which method to use for tests of significance, all data was tested for normality. In order to test for this, a statistical analysis function in MATLAB was used. This function plots the gathered data in such a way that it can be assessed if it could come from a normal distribution. Normal data results in linear plots, whereas plots that are not linear should be assumed to come from other types of distributions.

Normal distributions were obtained solely for the data in Chapter 8. The validation plots are shown below. The data in each plot represents each of the three levels of reference Q-factor tested. Two sets of plots are shown. Appendix Figure 2 and Appendix Figure 3 show normality tests for the whole data gathered. Appendix Figure 4 and Appendix Figure 5 show normality plots for the third run, which was used for the derivation of the main results. It can be seen that all data is close to linear plots and therefore considered normal.

All data gathered for the other tests was not normally distributed, and therefore non-parametric tests were used for the analysis of variance.

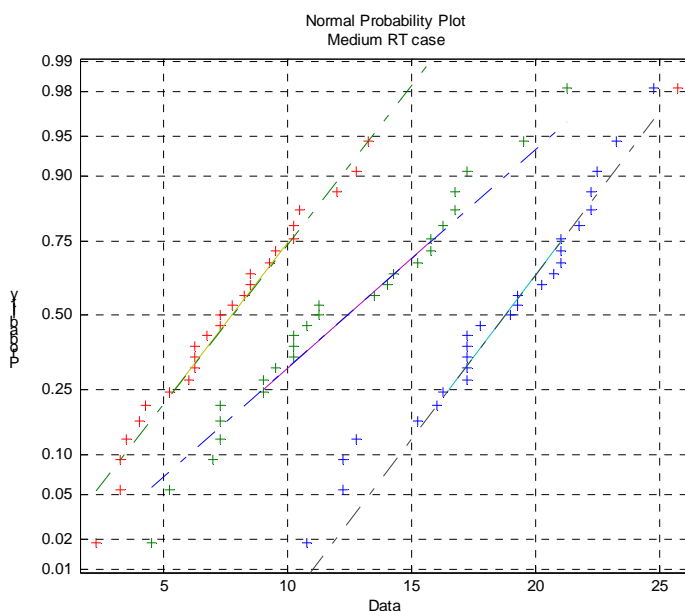

Appendix Figure 2

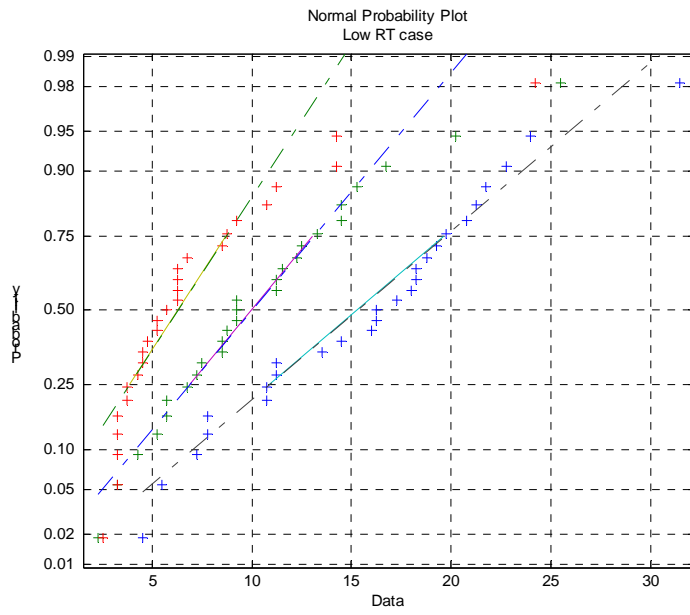

Appendix Figure 3

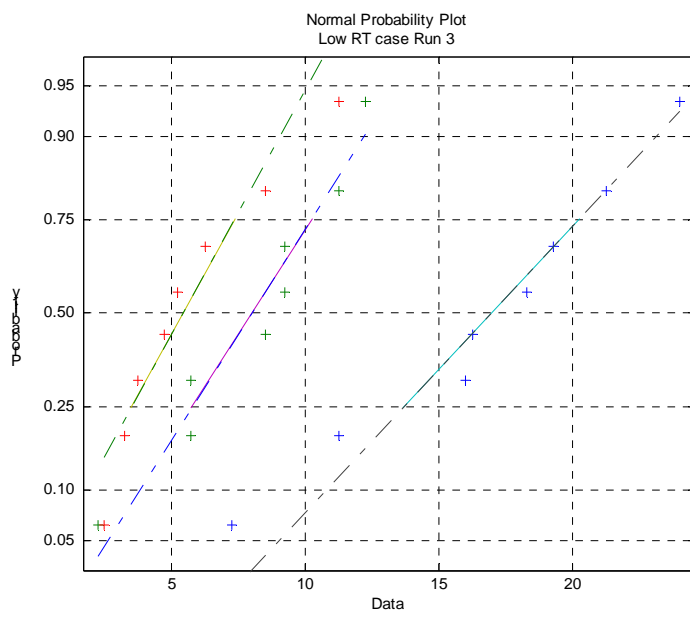

Appendix Figure 4

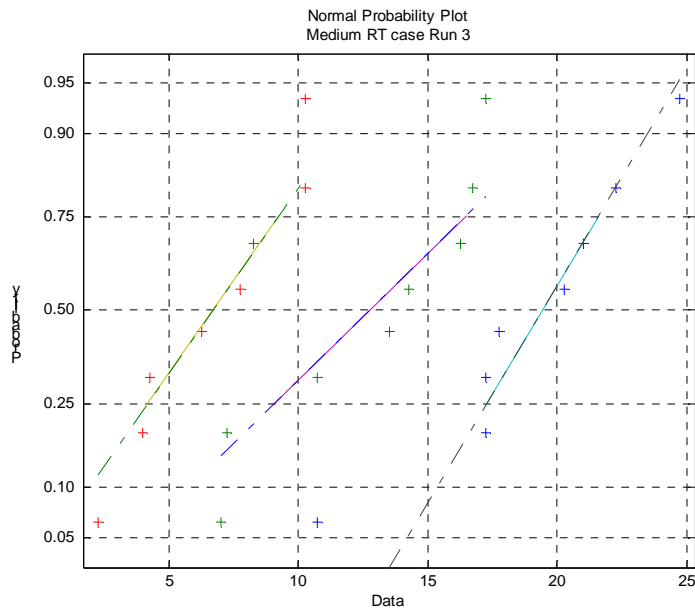

Appendix Figure 5

Appendix IV.iv Parametric and non-parametric analysis of variance

If two or more conditions were tested using the same group, the differences in the means obtained may be tested using an analysis of variance. If the original data is normally distributed, a common analysis of variance based on parametric data may be used. However, if there is no evidence that both sets of data are normally distributed, the tests for significance should employ a non-parametric test. These are usually less powerful, and a mistake of retaining H_0 when it is actually false, therefore committing a type II error, may occur.

In chapters 7 and 8, means are compared across conditions using a Friedman analysis of variance. This type of non-parametric test was used because there is no evidence to support that the data are obtained from normally distributed populations.

All statistical analysis in chapters 7 and 8 were carried out using a MATLAB Friedman analysis of variance function. The output is listed below for each case. The values extracted for the discussion in the main text are found under the heading 'Prob>chi-sq.' and indicate the probability that the means evaluated belong to the same population, that is, they describe the same experimental value. If this value is below 0.05 (5%), it is assumed that the differences in the means obtained are representative of an experimental effect.

The terms in each table correspond to intermediate results and definitions that are common to this type of statistical analysis. Their meaning is important for the procedure of the analysis and may be found in any statistics textbook. Hence, it is not described here.

Appendix Table 1 – Analysis of variance for Test A in chapter 6. Effects of music style.

Friedman's ANOVA Table – Effect of MUSIC STYLE					
Source	SS	df	MS	Chi-sq	Prob>Chi-sq
Columns	58.5	2	29.25	2.1296	0.34481
Interaction	24.66	2	12.3333		
Error	850.8	30	28.3611		
Total	934	35			
Test for column effects after row effects are removed					

Appendix Table 2 - Analysis of variance for Test A in chapter 6. Effects of contrast

Friedman's ANOVA Table – Effect of Contrast					
Source	SS	df	MS	Chi-sq	Prob>Chi-sq
Columns	61.36	1	61.3611	4.8734	0.027273
Interaction	15.39	2	7.6944		
Error	338.7	30	11.2917		
Total	415.5	35			
Test for column effects after row effects are removed					

Appendix Table 3 - Analysis of variance for Test B in chapter 6. Effects of contrast

Friedman's ANOVA Table – Effect of contrast					
Source	SS	df	MS	Chi-sq	Prob>Chi-sq
Columns	57.6	1	57.6	1.7351	0.18776
Interaction	19.6	1	19.6		
Error	1184.3	36	32.8972		
Total	1261.5	39			
Test for column effects after row effects are removed					

Appendix Table 4 - Analysis of variance for Test B in chapter 6. Effects of transposition.

Friedman's ANOVA Table – Effect of transposition					
Source	SS	df	MS	Chi-sq	Prob>Chi-sq
Columns	81.22	1	81.22	2.4851	0.11493
Interaction	0.22	1	0.225		
Error	1160.55	36	32.24		
Total	1242	39			
Test for column effects after row effects are removed					

Appendix Table 5– Analysis of variance for the effect of stimulus in Chapter 7.

Friedman's ANOVA Table – Effect of Stimulus					
Source	SS	df	MS	Chi-sq	Prob>Chi-sq
Columns	283.3611	1	283.3611	25.549	4.313e-007
Interaction	1.7222	2	0.86111		
Error	80.9167	30	2.6972		
Total	366	35			

Test for column effects after row effects are removed

Appendix Table 6– Analysis of variance for the effects of resonant system in Chapter 7.

<i>Friedman's ANOVA Table – Effects of type of resonant system</i>					
<i>Source</i>	<i>SS</i>	<i>df</i>	<i>MS</i>	<i>Chi-sq</i>	<i>Prob>Chi-sq</i>
<i>Columns</i>	210.0417	1	210.0417	18.41	1.7812e-005
<i>Interaction</i>	0.041667	1	0.041667		
<i>Error</i>	40.9167	20	2.0458		
<i>Total</i>	251	23			
<i>Test for column effects after row effects are removed</i>					

The following tables show the integral information for some of the results presented in the analysis of chapter 8.

Appendix Table 7– ANOVA for Chapter 8 including three factors; RUN, RT and Q.

Tests of Within-Subjects Effects

Source		Type III Sum of Squares	Df	Mean Square	F	Sig. (p)
RUN	Sphericity Assumed	60.03	2	30.01	1.41	0.270
RT	Sphericity Assumed	168.68	1	168.68	11.43	0.008
Q	Sphericity Assumed	2606.00	2	1303.00	65.99	0.000

Appendix Table 8 – ANOVA for Chapter 8, results performed on each of the three runs individually.

Tests of Within-Subjects Effects(a)

	Source		Type III Sum of Squares	df	Mean Square	F	Sig. (p)
RUN1	RT	Greenhouse-Geisser	42.50	1	42.50	2.45	0.152
	Q	Greenhouse-Geisser	736.14	1.16	633.57	21.59	0.001
RUN2	RT	Greenhouse-Geisser	24.70	1	24.70	0.87	0.377
	Q	Sphericity Assumed	803.09	2	401.55	32.73	0.000
RUN3	RT	Greenhouse-Geisser	121.13	1	121.13	15.49	0.003
	Q	Sphericity Assumed	1133.88	2	566.94	33.48	0.000

(a) for different runs

Appendix Table 9- ANOVA for Chapter 8, Run number 3.

Tests of Within-Subjects Effects

Source		Type III Sum of Squares	df	Mean Square	F	Sig. (p)
RT	Greenhouse-Geisser	121.126	1.000	121.126	15.493	.003
ErrorRT	Greenhouse-Geisser	70.364	9.000	7.818		
Q	Greenhouse-Geisser	1133.877	1.346	842.389	33.479	.000
ErrorQ	Greenhouse-Geisser	304.810	12.114	25.161		
RT*Q	Greenhouse-Geisser	26.077	1.240	21.038	3.582	.079
ErrorRT*Q	Greenhouse-Geisser	65.527	11.156	5.874		

Appendix Table 10– Chapter 8. Tests for Linear Trends in experimental data.

Tests of Within-Subjects Contrasts(a)

Measure: MEASURE_1

Source	RT	Q	Type III Sum of Squares	df	Mean Square	F	Sig.
Q		Linear	1115.664	1.000	1115.664	45.549	0.000
		Quadratic	18.213	1.000	18.213	1.943	0.197
Error(Q)		Linear	220.445	9.000	24.494		
		Quadratic	84.365	9.000	9.374		

Appendix V. List of References

Angus, J.A.S. "Distributed Mode Loudspeakers polar patterns", Preprint 5065 (E-6), Presented at the 107th Audio Engineering Society Convention, New York, USA, September 1999 (a)

Angus, J.A.S. "Distributed Mode Loudspeakers radiation mechanisms", Preprint 5164(S-6), Presented at the 108th Audio Engineering Society Convention, Paris, February 2000 (a)

Angus, J.A.S. "Distributed Mode Loudspeakers resonance structures", Presented at the 109th Audio Engineering Society Convention, Preprint 5217, Los Angeles, USA, September 2000 (b)

Angus, J.A.S. "The effect of diffusers on Frequency dependent room mode decay", Presented at the 107th Audio Engineering Society Convention, Preprint 5060(D-3), New York, USA, September 1999 (b)

Angus, J.A.S. "The reflection full zone", Proceedings of the Institute of Acoustics, Vol.18, Part. 8, pp. 235-244, 1996

Antsalos, P., Karjalainen, M., Makivirta, A., Valimaki, V. "Comparison of modal equalizer design methods", Audio Engineering Society convention paper, Presented at the 114th Convention, Netherlands 2003

Asano, F., Swanson, D. C. "Sound equalisation in enclosures using modal reconstruction", Journal of the Acoustical Society of America, Vol. 98, No.4, p. 2062, October 1995

Avis, M. R. "IIR biquad controllers for low frequency acoustic resonance", Audio Engineering Society convention paper 5474, Presented at the 111th Convention, USA 2001

Avis, M. R. "Q-factor modification for Low Frequency Room Modes", Presented at the 21st International Conference of the Audio Engineering Society, USA, May 2002

Avis, M. R., Copley, L. "Modelling DML panels using classical theory." Proceedings of the Institute of Acoustics Vol. 22, No. 6, 2000

Azima, H., Harris, N. "Boundary interaction of diffuse field distributed mode radiators", Audio Engineering Society convention paper 4635 (K-6), Presented at the 103rd Convention, USA 1997

Azima, H., Mapp, P. "Diffuse field distributed mode radiators and their associated early reflections", Audio Engineering Society convention paper 4759 (P14-6), Presented at the 104th Convention, Amsterdam 1998

- Moore, B., *An Introduction to the Psychology of Hearing*, 5th Edition, Academic Press, USA 2003
- Harper, B., “Welcome to the Cruel World”, Trk 2 –“Whipping Boy”, Virgin Records, 1995
- Ballagh, K. O. “Optimum loudspeaker placement near reflecting planes”, *Journal of the Audio Engineering Society*, Vol. 31, No. 12, pp. 931-935, December 1983
- Bech, S. "Perception of timbre of Reproduced Sound in Small Rooms: Influence of Room and Loudspeaker Position.", *Journal of the Audio Engineering Society*, Vol. 42, No. 12, December 1994
- Benjamin, E., Gannon, B. “Effect of room acoustics on Subwoofer performance and level setting”, A.E.S. Preprint 5232, Presented at the 109th Convention, USA, September 2000
- Beranek, L. *Acoustics*, 2nd Edition, Acoustical Society of America, USA, 1986
- Bolt, R. H. “Frequency Distribution of Eigentones in a three dimensional continuum”, *Journal of the Acoustical Society of America*, Vol. 10, p.228, January 1939
- Bolt, R. H. “Normal frequency spacing statistics”, *Journal of the Acoustical Society of America*, Vol. 19, No.1, p.79, January 1947
- Bolt, R. H. “Normal modes of vibration in room acoustics: angular distribution theory”, *Journal of the Acoustical Society of America*, Vol. 11, p.74, 1939
- Bonello, O. "A new criterion for the distribution of normal room modes." *Journal of the Audio Engineering Society*, Vol. 29, No.9, pp.597-605, 1981
- Boner, C.P., Boner, C. R., “Minimising feedback in sound systems and room ring modes with passive networks”, *Journal of the Acoustical Society of America*, Vol. 37, pp.131-135, January 1965
- Borwick, J. *Loudspeaker and Headphone Handbook*, 3rd Edition, Focal Press
- Bradley, J. S. “Sound absorption of gypsum board cavity walls”, *Journal of the Audio Engineering Society*, Vol. 45, No. 4, April 1997
- Brüel & Kjaer Technical Review, *Digital Filter Techniques vs. FFT Techniques*, No. 1 – 1994
- BS 6840: Part 13 “Sound System Equipment: Part 13: Guide for listening test on Loudspeakers” (1987)
- Bucklein, R. “The audibility of Frequency Response irregularities”, *Journal of the Audio Engineering Society*, Vol. 29, No. 3, March 1981

- Bullmore, A. J., Nelson, P. A., Curtis, A. R. D., Elliot, S. J. "The active minimization of harmonic enclosed sound fields, part II: A computer simulation", *Journal of Sound and Vibration*, Vol. 117, No. 1, pp.15-33, 1987
- Cox, T.J., D'Antonio, P. "Room Optimizer: A Computer Program to Optimize the Placement of Listener, Loudspeakers, Acoustical Surface Treatment, and Room Dimensions in Critical Listening Rooms", 103rd Convention of the Audio Engineering Society, Preprint 4555, Paper H-6, New York, September 1997
- Cox, T.J., D'Antonio, P., *Acoustic Absorbers and Diffusers*, Theory, Design and Applications, Spon Press, 1st Edition, London, New York, 2004
- Davis, D., Davis, C., "The LEDE concept for the control of acoustic and psychoacoustic parameters in recording control rooms", *Journal of the Audio Engineering Society*, Vol. 28, No. 9, pp585, 1980.
- Darlington, P., Avis, M. R. "Time/Frequency response of a room with active acoustic absorption", Audio Engineering Society preprint 4192(H-5), Presented at the 100th Convention, Copenhagen 1996
- Easterby-Smith, M., Thorpe, R., Lowe, A. *Management research: an introduction*, Sage Publications Ltd, 2nd Edition, 2002
- EBU Tech 3276 – 2nd Edition, "Listening conditions for the assessment of sound programme material", May 1998
- Everest, F. A. *The Master Handbook of Acoustics*, 3rd Edition, McGraw-Hill, USA, 1994
- Everest, F. A., *Sound studio design on a budget*, McGraw-Hill, USA, 1997
- Fahy, F. *Sound and structural vibration – Transmission and response*, Academic Press London, 1985
- Farnsworth, K. D., Nelson, P. A., Elliot, S. J., "Equalisation of room acoustic responses over spatially distributed regions", *Proceedings of the Institute of Acoustics*, Vol. 7, Part 3, 1985
- Ferekidis, C. Kempe, U. "Room mode excitation of dipolar and monopolar low frequency sources", Audio Engineering Society preprint 4193 (H-6), presented at the 100th AES convention, Copenhagen, May 1996
- Fielder, L. D. "Analysis of traditional and reverberation-reducing methods of room equalization", *Journal of the Audio Engineering Society*, Vol. 51 No.1/2, pp.597-605 February 2003

- Fryer, P. A. “Intermodulation listening tests”, presented at the 50th Convention of the Audio Engineering Society, Journal of the Audio Engineering Society abstracts, Vol. 23, p.402, June 1975
- Fuchs, H.V., Zha, X., Pommerer, M, “Qualifying freefield and reverberation rooms for frequencies below 100 Hz”, Applied Acoustics, Vol. 59, pp.303-302, 2000
- Genelec, www.genelec.com (accessed 10 June 2004)
- Groh, A. R. “High-Fidelity sound system equalization by analysis of standing waves”, Journal of the Audio Engineering Society, Vol. 22, No. 10, December 1974
- Guicking, D. “On the invention of active noise control by Paul Lueg”, Journal of the Acoustical Society of America, Vol. 87, No. 5, pp.2251-2254, May 1990
- Coolican, H., *Research Methods and Statistics in Psychology*, 3rd Edition, Hodder&Stoughton, 1999
- Herzog, P., Soto-Nicolas, A., Guery, F. “Passive and active control of the low frequency modes in a small room”, Audio Engineering Society preprint 3951(D1), Presented at the 98th Convention, Paris 1995
- Holland, K. R., Newell, P., Mapp, P. “Steady state and transient loudspeaker frequency responses”, Proceedings of the Institute of Acoustics, Vol.25, Part 8, 2003
- Howard, D. M., Angus, J. *Acoustics and Psychoacoustics*, Focal Press, 2nd Edition, UK, 1998
- Hunt, F. V. Beranek, L. L. Maa, Y. “Analysis of sound decay in rectangular rooms”, Journal of the Acoustical Society of America, Vol. 11, p.228, July 1939
- IEC Publication 268-13, *Sound system equipment, Part 13, Listening tests on loudspeakers*, 1985
- Irvine, L.K., Richards, R.L. *Acoustics and Noise Control Handbook for Architects and Builders*, Krieger Publishing Company, USA, 1997
- ITU-R BS 1116-1, *Methods for the assessment of small impairments in audio systems including multichannel sound systems*, 1994
- Karjalainen, M., Antsalo, P., Makivirta, A., Valimaki, V., “Perception of temporal decays of low-frequency room modes”, Proceedings of the 116th Audio Engineering Society Convention, Berlin, Germany, May 2004

- Kinsler, L.E., Frey, A.R., Coppens, A.B., Sanders, J.V., *Fundamentals of Acoustics*, (4th ed.) Wiley, New York 2000
- Kuttruff, H., *Room Acoustics*, (4th ed.) Spon Press, London (2000)
- Louden, M. M. “Dimension-Ratios of rectangular rooms with good distribution of eigentones”, *Acustica*, Vol. 24, 1971
- Maa, D. “Distribution of eigentones in a rectangular chamber at low frequency range”, *Journal of the Acoustical Society of America*, Vol. 10, p.235 January 1939
- Makivirta, A., Antsalo, P., Karjalainen, M., Valimaki, V. “Modal equalisation of loudspeaker – room responses at low frequencies”, *Journal of the Audio Engineering Society*, Vol. 51, No. 5, May 2003
- Maluski, S., Gibbs, B. M., “the effect of construction material, contents and room geometry on the sound field in dwellings at low frequencies”, *Applied Acoustics*, Vol. 65, pp.31-44, 2004
- Metheny, P. *Question and Answer*, Trk 4, Geffen Records, 1990
- Moore, B., *An introduction to the Psychology of hearing*, 5th Edition, Elsevier USA, 2003
- Morse, P.M., *Vibration and Sound*, 2nd edition, Acoustical Society of America, 1948
- Mourjopoulos, J., Paraksevas, M. A., “Pole and Zero modelling of room transfer functions”, *Journal of Sound and Vibration*, Vol. 146, No. 2, pp.281-302, 1991
- Mourjopoulos, M., “On the variation and invertibility of room impulse response functions”, *Journal of Sound and Vibration*, Vol. 102, No. 2, pp.217-228, 1985
- Neely, S. T., Allen, J. B. “Invertibility of a room response”, *Journal of the Acoustical Society of America*, Vol. 66, No.1, p.165, July 1979
- Newell P. *Studio Monitoring Design*, Focal Press, 1995
- Newell, P., Holland, K., “The Acoustic Trap Absorbers Systems: A Review of Recent Research”, *Proceedings of the Institute of Acoustics*, Vol. 25, Part 7, 2003
- Newell, P., Holland, K. R., “A proposal for a more perceptually uniform control for stereophonic music recording studios”, *Audio Engineering Society preprint 4580(K-9)*, Presented at the 103rd Convention, New York 1997
- Newell, P., Holland, K. R., Hidley, T., “Control room reverberation is unwanted noise”, *Proceedings of the Institute of Acoustics*, Vol.16, Part 4, 1994

- Niaounakis, T.I, Davies, W.J, "Perception of reverberation time in small listening rooms", Journal of the Audio Engineering Society, Vol.50, No.5, May 2002
- Olive, S., P. Schuck, Ryan, J. G., Sally, S. L., Bonneville, M. E. "The Detection Thresholds of Resonances at Low Frequencies.", Journal of the Audio Engineering Society, Vol. 45, No. 3, March 1997
- Olive, S., P. Schuck, Sally, S. L., Bonneville, M. E. "The effects of loudspeaker placement on listener preference ratings." Journal of the Audio Engineering Society, Vol. 42, No. 9, September 1994
- Pedersen, J. A., "Adjusting a loudspeaker to its acoustic environment – the ABC system", Journal of the Audio Engineering Society Convention Paper 5880, Presented at the 115th Convention, New York, October 2003
- Ramsete, <http://www.ramsete.com> (accessed 15 May 2004)
- Rivesaudio, <http://www.rivesaudio.com/PARC/> (accessed 16 August 2004)
- Salava, T. "Low-Frequency performance of listening rooms for steady-state and transient signals", Journal of the Audio Engineering Society, Vol. 39, No. 11, November 1991
- Santillan, A. O. "Spatially extended sound equalization in rectangular rooms", Journal of the Acoustical Society of America, Vol. 110, No.4, p. 1989, October 2001
- Schroeder, M. R., Kuttruff, H. "on frequency response curves in rooms. Comparison of experimental, theoretical and monte Carlo results for the average frequency spacing between maxima", Journal of the Acoustical Society of America, Vol. 34, No. 1, pp. 76-80, 1962
- Taylor, M. M., Creelman, C.D., "PEST: Efficient estimates on probability functions", Journal of the Acoustical Society of America, Vol. 41, No. 4, 782-786, 1967
- Taylor, M.M, Forbes, S.M, Creelman, C.D. "PEST reduces bias in forced choice psychophysics", Journal of the Acoustical Society of America, 74 (5), November 1983
- Toole, F. E. "Loudspeaker measurements and their relationship to listener preferences: Part 1", Journal of the Audio Engineering Society, Vol. 34, No. 4, April 1986
- Toole, F., Olive, S. "The Modification of Timbre by Resonances: Perception and Measurement.", Journal of the Audio Engineering Society, Vol. 36, No. 3, March 1988
- Toyoshima, S.M, Suzuki, H. "Control Room Acoustic Design", Journal of the Audio Engineering Society Preprint 2325(c3), Presented at the 80th Convention, Montreux, Switzerland, March 4-7, 1986

- Voelker, E.J. "Control rooms for music monitoring", *Journal of the Audio Engineering Society*, Vol. 33, No. 6, June 1985
- Voelker, E.J. "The V-criterion for good listening conditions in control rooms – on the importance of the first 15 ms", *Proceedings of the Institute of Acoustics*, Vol. 20, Part 5, 1998
- Voetmann, J. Klinkby, J. "Review of the low-frequency absorber and its application to small room acoustics", Preprint 3578 (G2-8), 1993
- Walker, R. "Low Frequency room responses – Part 2 – Calculation methods and experimental results", British Broadcasting Corporation, Research Department, Engineering Division, BBC RD 1992/9
- Walker, R. "Low frequency room responses. Part 1 – Background and qualitative considerations", British Broadcasting Corporation, Research Department, Engineering Division, BBC-RD 1992/8
- Warburton, G.B. "The vibration of rectangular plates", *Proc. Inst. Mech. Eng.*, Vol. 168, no.12, pp. 371-384, 1954
- Welti, S. T., Devantier, A. "In-Room low frequency Optimization", *Audio Engineering Society convention paper 5942*, Presented at the 115th Convention, USA 2003
- Wrightson, J. "Psychoacoustic considerations in the design of control rooms", *Journal of the Audio Engineering Society*, Vol. 34, No. 10, October 1986
- Z.Preisner, "Preisner's Music", EMI Records, 1999