



# University of HUDDERSFIELD

## University of Huddersfield Repository

Formosa, Saviour

Spatial analysis of temporal criminality evolution: an environmental criminology study of crime in the Maltese Islands

### Original Citation

Formosa, Saviour (2007) Spatial analysis of temporal criminality evolution: an environmental criminology study of crime in the Maltese Islands. Doctoral thesis, University of Huddersfield.

This version is available at <http://eprints.hud.ac.uk/id/eprint/964/>

The University Repository is a digital collection of the research output of the University, available on Open Access. Copyright and Moral Rights for the items on this site are retained by the individual author and/or other copyright owners. Users may access full items free of charge; copies of full text items generally can be reproduced, displayed or performed and given to third parties in any format or medium for personal research or study, educational or not-for-profit purposes without prior permission or charge, provided:

- The authors, title and full bibliographic details is credited in any copy;
- A hyperlink and/or URL is included for the original metadata page; and
- The content is not changed in any way.

For more information, including our policy and submission procedure, please contact the Repository Team at: [E.mailbox@hud.ac.uk](mailto:E.mailbox@hud.ac.uk).

<http://eprints.hud.ac.uk/>

**Spatial Analysis of Temporal  
Criminality Evolution:  
An Environmental Criminology Study  
of Crime in the Maltese Islands**

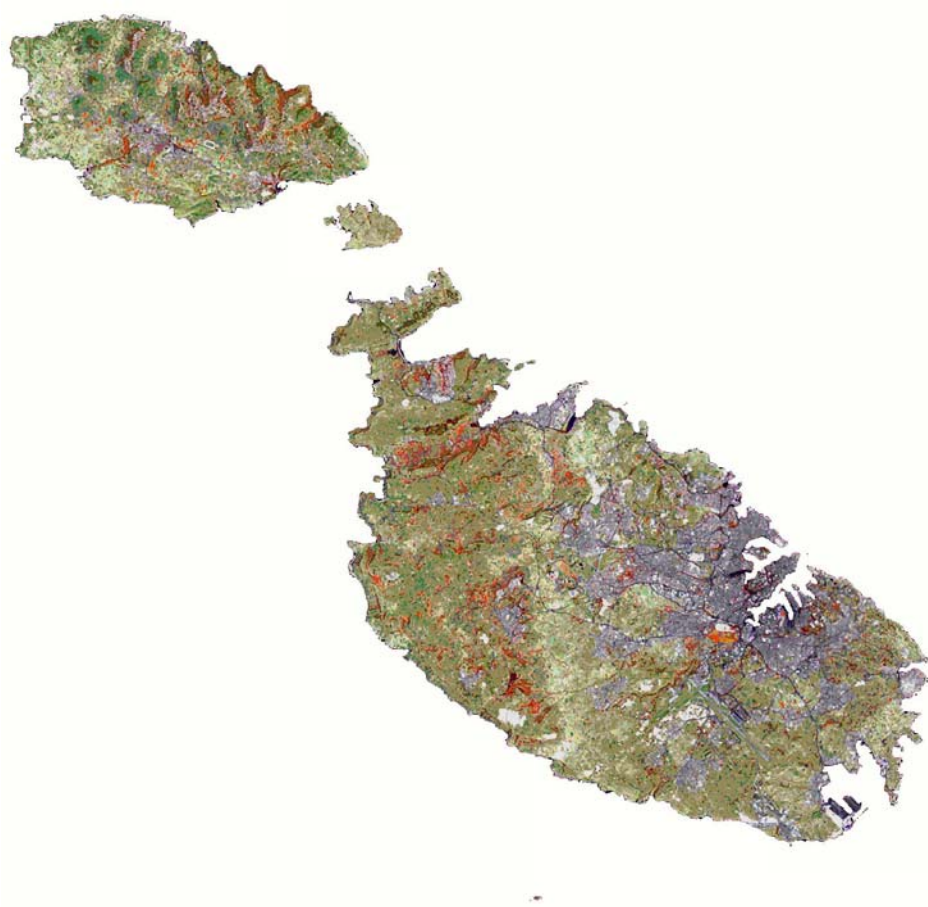
Saviour Formosa

A thesis submitted to the University of Huddersfield  
in partial fulfilment of the requirements  
for the degree of Doctor of Philosophy

July 2007

“What follows is not a plea for less mapping: but for the placement of spatial mapping alongside other dimensions in terms of which crime risks and offender attributes vary”

Ken Pease, 2001



## **Abstract**

The study, the first of its kind in the Maltese Islands, reviewed crime in a spatio-temporal aspect based on where offenders live, interact and commit crime. The study has sought to develop an understanding of the Maltese Islands' crime within a social and landuse structure through the employment of high-end GIS tools.

A study at European and Small Islands level resulted in a relative safety-danger dynamic score model that shows that Malta is safe, though progressively decreasing in relative safety. A 40-year analysis depicted increasing crime rates as well as changes in crime categories. Findings highlight a high foreign prisoner component, highly-specific local-offender social situations with residential and poverty clustering. The findings show that the Maltese offender is male, young, a recidivist, increasingly less literate, has had a secondary education, single, unemployed and increasingly partaking to serious crimes.

Residential analysis show a preference for the harbour region where offenders live in areas characterised by poverty that have disproportionate offender concentrations when compared to their shrinking population concentration. Offences committed by convicted offenders fall within high dwelling concentrations, vacant dwelling concentrations, apartment zones and low population density areas. Offender-offence findings show that Maltese offenders commit crime close to their residence mostly travelling less than 5 km.

Reported offence analysis results in high summer rates, with specific weekend to weekday differences, concentrated in a relatively small area within the conurbation with unique hotspots in fringe recreational localities. An analysis of landuse categories identified that residential areas host the highest offence counts, particularly serious crimes, whilst retail-related crime activities directly effect neighbourhoods through distance travelled from the retail entity.

Outputs from the research include a conceptual model based on the crime, social and landuse constructs, a league-table of crime-mapping sites and the creation of a web-enabled Crimemap system for the Maltese Islands.

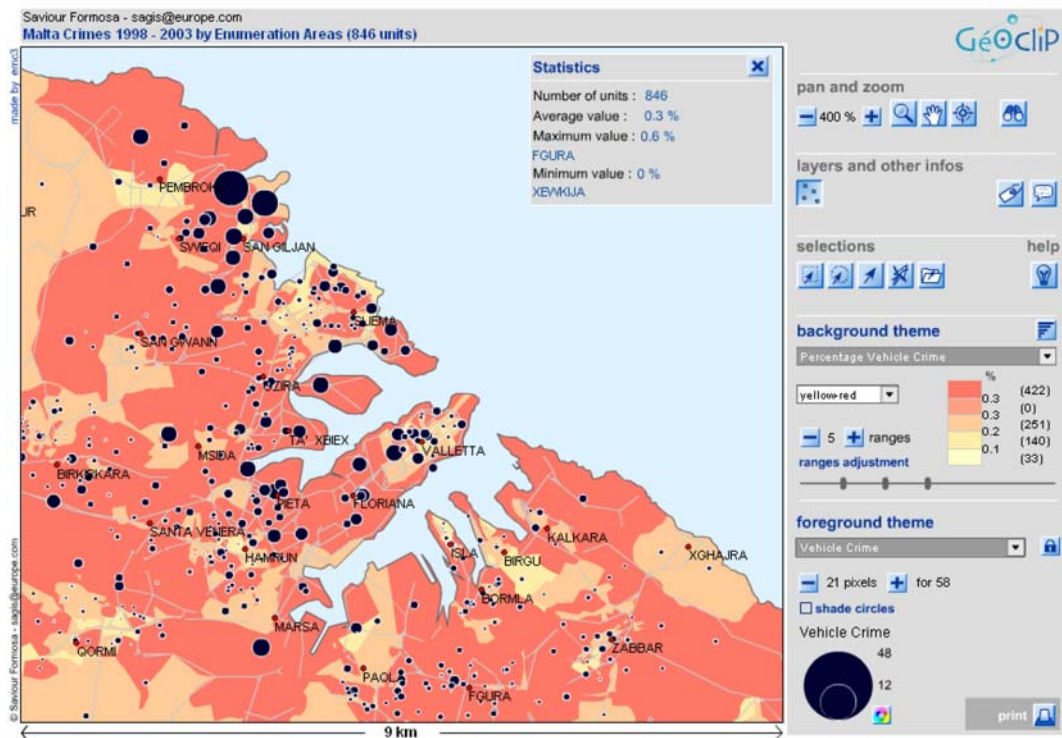


## Thesis Website

This thesis is accompanied by a website covering the first Maltese crime-mapping system. It is based on flash technology which enables users to view the Malta map at enumeration area levels (small spatial units comprising 150 households as based on Malta Census designations). Data is available for crimes from 1998 to 2003.

The website is available at the following address:

[www.crimemalta.com](http://www.crimemalta.com)



<b>Contents</b>	
<b>Abstract</b>	<b>i</b>
<b>Thesis Website</b>	<b>ii</b>
<b>Contents</b>	<b>iii</b>
<b>Index of Tables</b>	<b>vi</b>
<b>Index of Figures</b>	<b>ix</b>
<b>Disclaimer</b>	<b>xiii</b>
<b>Statement of Assistance</b>	<b>xiv</b>
<b>Acknowledgments</b>	<b>xv</b>
<b>Chapter 1: Introduction</b>	<b>1</b>
<b>1.1 Aim of the Research</b>	<b>1</b>
<b>1.2 Introduction to the topic</b>	<b>1</b>
<b>1.3 Chapter Structure</b>	<b>4</b>
<b>Chapter 2: Literature Review: Environmental Criminology</b>	<b>8</b>
<b>2.1 Crime: an introduction</b>	<b>8</b>
<b>2.2 Review of environmental criminology theory</b>	<b>15</b>
<b>2.3 Related Theories</b>	<b>28</b>
<b>2.4 Physical and Social issues</b>	<b>33</b>
<b>Chapter 3: Research Questions</b>	<b>39</b>
<b>3.1 Introduction</b>	<b>39</b>
<b>3.2 Aims and Objectives</b>	<b>39</b>
<b>3.3 The Conceptual Model</b>	<b>42</b>
<b>3.4 The Research Questions</b>	<b>52</b>
<b>Chapter 4: Crime-Mapping and GIS Review</b>	<b>60</b>
<b>4.1 Crime-Mapping: How it came about</b>	<b>60</b>
<b>4.2 Spatial analysis and its impact on social research</b>	<b>75</b>
<b>4.3 Need for information systems: where was the need for GIS highlighted</b>	<b>76</b>
<b>Chapter 5: The Maltese Scenario: Setting the Scene</b>	<b>80</b>

5.1	<b>Dynamics of Maltese society: Overview of historical issues</b>	<b>80</b>
5.2	<b>Political, Religious, Educational, Family and Economic (PREFE) influences in the Maltese Islands</b>	<b>98</b>
5.3	<b>Crime in Malta</b>	<b>115</b>
<b>Chapter 6: Methodology</b>		<b>127</b>
6.1	<b>Methods introduction</b>	<b>127</b>
6.2	<b>Data gathering exercise: the process and the hurdles</b>	<b>131</b>
6.3	<b>Data available for this study</b>	<b>142</b>
6.4	<b>Data analysis</b>	<b>148</b>
6.5	<b>Analysis techniques</b>	<b>153</b>
6.6	<b>Outputs</b>	<b>155</b>
<b>Chapter 7: Crime Analysis: Malta in an International Perspective and Generic Analysis 1950-1999</b>		<b>157</b>
7.1	<b>Offences in Malta - a 40 year perspective of crimes known to the police</b>	<b>158</b>
7.2	<b>Malta in the Wider World</b>	<b>163</b>
7.2	<b>A European perspective</b>	<b>165</b>
7.3	<b>An Island Perspective</b>	<b>175</b>
<b>Chapter 8: Crime analysis in relation to social issues and poverty: an offender-offence approach</b>		<b>192</b>
8.1	<b>Analysis of ‘convicted’ offender trends in Malta between 1950-1999</b>	<b>192</b>
8.2	<b>What are the social parameters that affect offenders?</b>	<b>234</b>
8.3	<b>What are the offence aspects that have an impact on social parameters?</b>	<b>252</b>
8.4	<b>The Offender-Offence Relationship</b>	<b>266</b>
<b>Chapter 9: Offence Analysis: 1998-2003</b>		<b>275</b>
9.1	<b>Temporal Considerations</b>	<b>275</b>
9.2	<b>Spatial Level Considerations</b>	<b>292</b>
9.3	<b>The Spatial Construct</b>	<b>305</b>
9.4	<b>The Structural and Use Constructs</b>	<b>308</b>
<b>Chapter 10: Conclusion</b>		<b>323</b>
10.1	<b>Conceptual Model and GI</b>	<b>323</b>
10.2	<b>Research Findings</b>	<b>324</b>

<b>10.3</b>	<b>Implications of the study on policy making and crime prevention</b>	<b>329</b>
<b>10.4</b>	<b>Points for further study</b>	<b>333</b>
	<b>Bibliography</b>	<b>337</b>
	<b>Appendices</b>	<b>355</b>
	<b>Appendix 1: Abbreviations</b>	<b>356</b>
	<b>Appendix 2 : Geographical Information Systems (GIS)</b>	<b>357</b>
	<b>Appendix 3: Creating a new Crime Classification System for the Maltese Islands</b>	<b>363</b>
	<b>Appendix 4: Metadata</b>	<b>378</b>
	<b>Appendix 5: Lineage - Geocoding crime data for the Maltese Islands</b>	<b>385</b>
	<b>Appendix 6: UN Crime Definition and Malta in Europe and in islands Perspectives</b>	<b>391</b>
	<b>Appendix 7: Offences in Malta - a 50 year perspective</b>	<b>406</b>
	<b>Appendix 8: Crime Maps – Overlaying Offender and Poverty Hotspots by Locality</b>	<b>411</b>
	<b>Appendix 9: Craglia et al (2000) Rate and Risk Assessment Methodologies</b>	<b>415</b>
	<b>Appendix 10: Crime Maps: Overlaying Offence and Recreation Hotspots by Locality</b>	<b>420</b>

## Index of Tables

Table 3.1: Phase 1 - Conceptual Model Logical Matrix .....	44
Table 4.1: SWOT Analysis of the use of GIS for Crime Research .....	66
Table 4.2: League-Table of sites that have a Web Crime-mapping component .....	71
Table 5.1: Localities classified by Settlement Type .....	96
Table 5.2: Dwelling Units by Type permitted 2000-2005 .....	97
Table 5.3: Government Health Centres Catchments .....	104
Table 5.4: Employment Trends .....	106
Table 5.5: Unemployment Trends .....	107
Table 5.6: Registered Unemployed Classified By Occupation .....	108
Table 5.7: Registered Unemployed by Age Distribution .....	108
Table 5.8: Poverty Indicators .....	110
Table 5.9: Percentage Distribution per Local Plan Area .....	112
Table 5.10: Percentage Share of Tourist Arrivals by Season .....	114
Table 5.11: Courts in the Maltese Judiciary System .....	116
Table 5.12: Crime categories and Sub-Categories reported to the Police: 1998-2001 .....	123
Table 5.13: Crimes per 1000 persons – a country comparison .....	124
Table 6.1: List of Datasets created through the research process .....	143
Table 6.2: Spatial data Aggregations that have been used to analyse the research data .....	145
Table 7.1: Type of Offence - 1000 persons: 1950-1997 (July) .....	159
Table 7.2: Type of Offence - 1000 persons: 1997 (Aug) - 2005 .....	161
Table 7.3: Offences Counts and Offences per 1000 persons: 1960s to 2005 .....	162
Table 7.4: Crime Categories .....	165
Table 7.5: EU Country League Table: 2000 ...cont.....	167
Table 7.6: Malta’s relative position in the league table based on the European mean: 2000 .....	173
Table 7.7: European Grand Total Crimes Cluster Analysis: 2000 .....	174
Table 7.8: Islands Country League Table: 2000 .....	177
Table 7.9: Malta’s relative position in the league table based on the Islands mean: 2000 .....	181
Table 7.10: Islands Grand Total Crimes Cluster Analysis .....	182
Table 7.11: Comparative Macro-Micro Analysis Table: 2000 .....	185
Table 7.12: Seriousness and Mean Placing Weightings .....	188
Table 7.13: Crime categories Matrix Calculations – Malta’s ‘relative safety-danger’ position .....	189
Table 8.1: Residence Location of Offenders from 1950 to 1999 .....	193
Table 8.2: International Offender residence: the 1950s: percentage .....	195
Table 8.3: International Offender residence: the 1990s: percentage .....	195
Table 8.4: Offender Sentence Categories – 1950s to 1990s .....	196
Table 8.5: Offenders in prisons – 1950s to 1990s .....	197
Table 8.6: Crosstabulations and Chi-Square Tests for Age Cohorts and Convictions over the Decades .....	199
Table 8.7: Literacy of known offenders: 1950 - 1999 .....	202
Table 8.8: Crosstabulations and Chi-Square Tests for type of schooling and known offenders over time .....	204
Table 8.9: Crosstabulations and Chi-Square Tests for recidivism and time .....	209
Table 8.10: Crosstabulations and Chi-Square Tests for recidivism and age .....	210

Table 8.11: Crimes by seriousness: 1950 - 1999 .....	213
Table 8.12: Offenders' residence in the conurbation: 1950 - 1999 .....	216
Table 8.13: Offenders' residence in the cities and towns: 1950 - 1999 .....	217
Table 8.14: Offenders' residence in the UCA and Village Cores: 1950 - 1999 .....	218
Table 8.15: Percentage Offenders by Region sorted by 1950-1999 data .....	219
Table 8.16: Percentage Offenders and Population by Locality sorted by 1950-1999 data and change 1980s-1990s: NUTS 5 ... cont.....	223
Table 8.17: Offender K-means clustering output sorted by 1990-1999 data .....	226
Table 8.18: Crosstabulations and Spearman Correlation Tests for Poverty risk and Dwelling density .....	237
Table 8.19: Moran's I spatial statistics tests for Poverty risk and Dwelling density .....	238
Table 8.20: Crosstabulations and Spearman Correlation Tests for population density and offender density .....	242
Table 8.21: Crosstabs Rate assessment of Population and Offender Densities .....	244
Table 8.22: Moran's I spatial statistics tests for offender rate and population density .....	244
Table 8.23a: Population and Offender Densities Change Analysis: 1980s-1990s ...	245
Table 8.23b: Decreasing Population and Increasing Offender Densities Change Analysis: 1980s-1990s .....	245
Table 8.24: Crosstabulations and Spearman Correlation Tests for Population Density and Poverty .....	246
Table 8.25: Moran's I spatial statistics tests for Poverty rate and Population density .....	249
Table 8.26: Crosstabulations and Spearman Correlation Tests for Offender Density and Poverty Rate .....	250
Table 8.27: Moran's I spatial statistics tests for Poverty risk and Offender rate .....	252
Table 8.28: Crosstabulations and Spearman Correlation Tests for Poverty risk and Dwelling density .....	253
Table 8.29: Percentage Reported Offences by Zoning: 1998 – 2003: by seriousness and unique offence categories .....	255
Table 8.30: Crosstabulations and Spearman Correlation Tests for Offences and Vacant Dwelling density .....	256
Table 8.31: Moran's I spatial statistics tests for Offence risk and Vacant Dwelling density .....	257
Table 8.32: GEOPOL and COTC Offence Densities by Dwelling Type .....	258
Table 8.33: GEOPOL and COTC Offence committed within UCAs and their boundaries .....	261
Table 8.34: Crosstabulations and Spearman Correlation Tests for Poverty risk and Offence rate .....	264
Table 8.35: Crosstabulations and Chi-Square Tests for Journey-to-crime and offence by type .....	269
Table 9.1: Malta's seasons – based on tourism categorisation .....	276
Table 9.2: Seasonal crime: annual changes .....	276
Table 9.3: Crosstabulations and Chi-Square Tests for Seasons and Crime Categories .....	279
Table 9.4: K-Means clustering by day-night periods .....	288
Table 9.5a: Offence categories share by time periods .....	291
Table 9.5b: Property offences' share by time periods: Highest Localities .....	291
Table 9.5c: Person offences' share by time periods: Highest Localities .....	291
Table 9.5d: Drugs Offences' share by time periods: Highest Localities .....	291
Table 9.6: Chi-Square Tests for Number of Offences by Locality .....	293

Table 9.7: Percentage Offences and Population by Locality sorted by 1998-2003 data and change 2002-2003: NUTS 5 .....	294
Table 9.8: Walled Cities offence league table: 1998 to 2003 .....	308
Table 9.9: Offences by landuse zones .....	311

## Index of Figures

Figure 2.1: Crime changes across space (state) and time (years) .....	9
Figure 2.2: Mayhew's 'Intensity of Criminality' map .....	10
Figure 2.3: Park and Burgess's zone model of urban development .....	17
Figure 2.4: Kawachi et al's description of the Social Capital Disinvestment .....	26
Figure 2.5: Wikstrom's model of variations in and types of crime in the urban environment .....	32
Figure 2.6: Ekblom's Problem Space: A Map of Symptoms and Crime Reduction Objectives .....	33
Figure 3.1: Conceptual Model Phase 2 – Linkages – Themes - Key .....	49
Figure 3.2: Conceptual Model Phase 2 – Linkages – Themes - Key .....	50
Figure 3.3: Conceptual Model Phase 3 – Datasets, variables and Statistical measures model cont.....	51
Figure 4.1: Analytical Constructs and Dimensions .....	63
Figure 4.2: Web-GIS Example - No Interactivity .....	69
Figure 4.3: Image-maps with simple interaction .....	69
Figure 4.4: Real Web-GIS functionality with limited querying functionality .....	70
Figure 4.5: Full Web-GIS with full querying functionality .....	70
Figure 4.6: Malta Crime Web-GIS prototype .....	74
Figure 4.7: Layering Concept .....	75
Figure 5.1: Population Density Map – 1995 .....	81
Figure 5.2: 3D Prism Population Density Map - 1995 .....	82
Figure 5.3: Walled Cities of the Maltese Islands .....	82
Figure 5.4 Population Pyramids of the Maltese Islands between 1957 and 1995 (2010-2020 projected) .....	84
Figure 5.5: International Migration: 1930 – 1997 .....	86
Figure 5.6: Population Changes: 1957 & 1995 (Valletta and Marsascala) .....	87
Figure 5.7: Local Plan Areas (Planning Regions) .....	88
Figure 5.8: Internal Migration: 1996 – Inter-Local Plan Migration .....	89
Figure 5.9: Internal Migration: 1996 – Grand Harbour Local Plan Area Movements .....	90
Figure 5.10: Urban Growth 1910 to 1995 .....	91
Figure 5.11: Urban Growth 1942 and 2001 .....	92
Figure 5.12: Conurbation and Suburbs .....	94
Figure 5.13: Ribbon Development in Gozo and Compact in Malta .....	95
Figure 5.14: Localities classified By Type .....	96
Figure 5.15: Dwelling Units by Type permitted 2000-2005 .....	97
Figure 6.1: Convicted Homicide Offenders serving Life sentences .....	135
Figure 6.2: Sensational Reporting that may thwart scientific research due to its intrinsic nature .....	135
Figure 6.3: Data inputting at the National Archives – a prison ledger of convicted persons .....	136
Figure 6.4: Report depicting Crime Data Input as part of the Archives work .....	137
Figure 6.5: Creating a buffer of 5metres for each street helped to develop a series of raster and vector maps that generated points for geocoding anchors .....	140
Figure 6.6: Rasterising the buffer points .....	140
Figure 6.7: Checking attribute data for matching to centreline through manual or automatic means .....	140
Figure 6.8: Cleaning the tabular data prior to geocoding .....	141
Figure 6.9: Checking for missing data in MEPA mapserver and on-line datasets .....	141
Figure 6.10: Geocoding the dataset based on dispersed points within the buffer .....	141



Figure 6.11: The final Result overlaid on other base data layers	142
Figure 6.12: Map Data Aggregations	146
Figure 6.13: Interpolation of Non-Serious Offences – 1998-2003	150
Figure 7.1: Type of Offence - 1000 persons: 1960-1997 (July)	160
Figure 7.2: Offences Counts and Offences per 1000 persons: 1960s to 2005	162
Figure 7.3: Europe Grand total of recorded crimes – Graduated Map	169
Figure 7.4: European Grand Total Crimes Cluster Map	175
Figure 7.5: Islands Grand Total of recorded crimes – Graduated Map	178
Figure 7.6: Islands Grand Total Crimes Cluster Analysis	182
Figure 7.7: Relative Safety-Danger Score Model: 1998-2000	189
Figure 8.1: Residence Location of Offenders from 1950 to 1999	193
Figure 8.2: International Offender Source Country: 1950 to 1999	194
Figure 8.3: Foreigners in Country Prisons as a percentage of total convicted 1998 – 2000 – an international perspective	196
Figure 8.4: Offenders in prisons – 1950s to 1990s	197
Figure 8.5: Offenders’ Age Cohorts – 1950s to 1990s	200
Figure 8.6: Spatial location of offenders in the 1990s	200
Figure 8.7: Spatial location of offenders in the 1990s – Detail	201
Figure 8.8: Literacy: 1950 - 1999	202
Figure 8.9a: School level achieved amongst known offenders: 1950 – 1999 (highest school categories)	203
Figure 8.9b: School level achieved amongst known offenders: 1950 – 1999 (lowest school categories)	205
Figure 8.10: Marital status: 1950 - 1999	206
Figure 8.11: Known offender employment categories based on ISCO: 1950 – 1999	207
Figure 8.12: Recidivism instances: 1950 - 1999	209
Figure 8.13: Recidivism categories: 1950 - 1999	210
Figure 8.14: Recidivism age cohorts: 1950 - 1999	211
Figure 8.15: Poverty Map of the Grand Harbour region: 2003	211
Figure 8.16a: Crimes by seriousness: 1950 - 1999	213
Figure 8.16b: Serious crimes: 1950 - 1999	214
Figure 8.17: Conurbation Standard Deviation Ellipse at 1NNH and 2NNH	216
Figure 8.18: Offences in the HOSs: 1950 - 1999	218
Figure 8.19: Percentage Offenders by Region sorted by 1950-1999 data	220
Figure 8.20: Percentage Offenders by Region sorted by 1990-1999 data - map	220
Figure 8.21: Offender K-means clustering output sorted by 1990-1999 data	225
Figure 8.22: A 2NNH map showing all the hotspots concentrated in the main conurbation between 1950 and 1999	227
Figure 8.23a-d: 2NNH (Spatial Clustering) inter-decade change 1950s – 1990s	228
Figure 8.24: A 1NNH map showing all the hotspots between 1950 and 1999	229
Figure 8.25a-d: 1NNH (Spatial Clustering) inter-decade change 1950s – 1990s	230
Figure 8.26a: A 2NNH map showing the 1990s hotspots and the offender location	232
Figure 8.26b: 1NNH (blue) and 2NNH (red) map: Three Cities 1990s’ hotspots	232
Figure 8.26c: 1NNH (blue) and 2NNH (red) map: Pieta 1990s’ hotspots	233
Figure 8.26d: 1NNH (blue) and 2NNH (red) map: Valletta 1990s’ hotspots	233
Figure 8.27: Poverty Buffering	235
Figure 8.28a: Poverty Buffering Grid File – Top View	236
Figure 8.28b: Poverty Buffering Grid File – Perspective View	236
Figure 8.29: 1NNH hotspot analysis for offender residence and poverty	238
Figure 8.30: HOS -poverty relationship	239
Figure 8.31: Formula for the calculation of Risk of Poverty based on Population	241
Figure 8.32: Map of Population and Offender Densities Rate Assessment	243

Figure 8.33: Graphical Poverty Rate – Enumeration Areas .....	247
Figure 8.34: 3D population density map – Enumeration Areas .....	248
Figure 8.35: 3D risk of poverty maps – Enumeration Areas .....	248
Figure 8.36: Risk of Poverty map draped over a population density map .....	249
Figure 8.37: 1NNH hotspot analysis for offender residence and poverty .....	251
Figure 8.38: Dwelling type zones .....	257
Figure 8.39: Offence categories by dwelling type zones .....	259
Figure 8.40: GEOPOL and COTC Offence Densities by Dwelling Type .....	260
Figure 8.41: Offence Rate across the UCA_Village Cores buffer zones .....	261
Figure 8.42a: Offence densities: top perspective .....	262
Figure 8.42b: Offence densities: 3D perspective .....	262
Figure 8.43: Offences within 100m buffer of all school locations in the Maltese Islands between 1998 and 2003 .....	263
Figure 8.44: Offences and Poverty hotspots: 1998-2003 .....	265
Figure 8.45: The Maltese Islands Journey-to-Crime Web .....	266
Figure 8.46: The Maltese Islands Journey-to-Crime Web: the case for Birgu .....	267
Figure 8.47: Journey-to-Crime Distance .....	268
Figure 8.48: Journey-to-Crime Distance – Council matrix .....	271
Figure 8.49: Journey-to-Crime Distance – Serious offences .....	272
Figure 8.50: Journey-to-Crime Distance – Non-Serious offences .....	272
Figure 9.1: Percentage Monthly Offences by Year: 1998 – 2003 .....	277
Figure 9.2: Percentage Monthly Offences by Category: 1998 – 2003 .....	278
Figure 9.3: Crimes by season .....	280
Figure 9.4: Crimes by weekday-weekend .....	281
Figure 9.5: Crimes by weekday by month .....	281
Figure 9.6a: Weekend-Weekday All Offence Categories Clusters .....	282
Figure 9.6b: Weekend-Weekday Against the Person Offence Clusters .....	283
Figure 9.6c: Weekend-Weekday Offence Property Categories Clusters 16.....	284
Figure 9.6d: Weekend-Weekday Drugs Offence Clusters .....	285
Figure 9.7a: Crimes by Time: highest ranking .....	287
Figure 9.7b: Crimes by Time: lowest ranking .....	287
Figure 9.8a: Day K-Means clustering .....	288
Figure 9.8b: Night K-Means clustering .....	288
Figure 9.9: K-Means clustering by day-night periods – comparative analysis .....	289
Figure 9.10: Offence Standard Deviational Ellipse (SDe) at 1NNH and 2NNH .....	292
Figure 9.11: District offences by region .....	297
Figure 9.12: District offences by region: map .....	297
Figure 9.13: 3NNH (Spatial Clustering) inter-year change analysis 1998-2003 - at 25 points minimum per hotspot .....	298
Figure 9.14a-e: 3NNH (Spatial Clustering) inter- annual change analysis 1998-2003 - at 25 points minimum per hotspot .....	300
Figure 9.15: 2NNH (Spatial Clustering) inter-annual change analysis 1998-2003 - at 25 points minimum per hotspot .....	302
Figure 9.16a-e: 2NNH (Spatial Clustering) inter- annual change analysis 1998-2003 - at 25 points minimum per hotspot .....	303
Figure 9.17: Landuse zones .....	309
Figure 9.18: Offences by landuse zones .....	310
Figure 9.19: Offence category by Landuse Zone: Percentage .....	312
Figure 9.20: Town Centre Offences: 3D map .....	314
Figure 9.21: Retail offences by buffer distance .....	316
Figure 9.22a-d: Photos of Paceville recreational zones .....	317
Figure 9.23: 3D point density – vehicle crime .....	318

Figure 9.24a: NNH geopol hotspots overlaid on recreational hotspots - Valletta	. 319
Figure 9.24b: NNH geopol hotspots overlaid on recreational hotspots - San Giljan	..... 320
Figure 9.24c: NNH geopol hotspots overlaid on recreational hotspots – Rabat – Gozo (Victoria)	..... 320
Figure 9.24d: NNH geopol hotspots overlaid on recreational hotspots - San Pawl il-Bahar	..... 321

## **Disclaimer**

The results presented in this thesis are based on my own research in the Applied Criminology Centre, University of Huddersfield. All assistance received from other individuals and organisations has been acknowledged and full reference is made to all published and unpublished sources used.

This thesis has not been submitted previously for a degree at any Institution.

Signed:

Saviour Formosa

Date: 7th July 2007

## Statement of Assistance

The Malta crime-mapping project was carried out entirely on my initiative, following a series of data gathering exercises carried out at diverse organisations, which process was launched in 1997 aimed gathering data for this research. Dr. Godwin Cassar, Director General of MEPA approved the use of the GI data on spatial planning as well as aerial imagery. The various Home Affairs and Interior Ministers approved the use of crime data and information that was not previously made public. These included Dr. Gavin Gulia in 1997 and Dr Tonio Borg in 2000. The Commissioner of Police approved the access to data from the police force. The Director General of the National Statistics Office approved use of data from their publications. Access to information was also granted by the diverse Directors of prison and the heads of the National Archives at Santo Spirito, Rabat. Social and welfare data was approved by the Minister of Social Policy (MSP) and subsequently the Prime Ministers Office (PMO).

Assistance was given by the following persons:

Stephen Conchin (MEPA), data input, conversion and creation of diverse maps inclusion of the Enumeration Area map;

Ashley Farrugia (MEPA), data input, conversion and creation of diverse maps inclusion of the Enumeration Area map;

Carol Agius (MEPA), MapInfo MapBasic tool creator for the randomization of crime locations

Mariela Dobreva (MEPA), lotus questionnaire development

ICT Unit Staff (MEPA), input on systems and technologies

Major Vince Vassallo and Sgt. Richard Zammit (CCF Prison) access to the prison ledgers and aiding input of data

Inspector Paul Caruana and WPC Priscilla Caruana (Police IT-Statistics Unit), provision of reported offences and other data

Robert Mizzi (NSO), provision of data and information

Leonard Callus (MSP and PMO), welfare data provision and access

Janice Formosa Pace, Emanuel Formosa, Simone Attard (family members), offender data mining and input of the 8000plus files

Dr. Ned Levine (Ned Levine & Associates), feedback on spatial statistics and Crimestat queries

## **Acknowledgments**

This thesis has proven a veritable minefield in every term imaginable; time-wise (10 years to input, analyse and write-up), access-wise (access to data was either impossible or gain or too costly to acquire), technology-wise (crime-specific software inexistent or early prototypes but improved over the period), input-wise nightmares (nearly all Malta crime data is in analogue book format and very few in digital (but non-spatial) format, apart from spatial planning), and finally health-wise (virtual sleep episodes for the last 5 years).

Each phase was tackled through hard determination verging on the obsessive as all data from the prisons was manually copied onto new sheets in a self-imposed '5-year sentence' and transferred to digital format at home. The georeferencing process proved another first and a method now exists to convert the information entrenched in paper and digital format into a readable spatial format.

The thesis has allowed me to integrate a number of technologies, software, analytical processes and methods that originally seemed too disjointed to ever come close to fit in an understandable function. The tools ranged from mindmapping applications, high-end mapping GIS systems, spatial statistical and social statistical tools, 2D and 3D graphics software to web-enabled tools. These was particularly employed to demonstrate that both physical and social research can be done through the employment of high-end statistical and spatial analysis, something still unheard of in the local Maltese academic, economic and political establishments. Luckily, this is changing as initial reaction to presentations of the results of this study was received.

However, this research has also made me realise that it is practically impossible to carry out a study of this scale without continuous and right-on-time support. Therefore, it is my duty at this stage to thank those persons who became my backbones.

A special thanks go to Professor Alex Hirschfield, my Director of Studies for his everlasting source of feedback and prods in the right direction and primarily because he gave me such high-level expertise as is difficult to find elsewhere. Other persons from the University of Huddersfield who gave me the best support and encouragement possible included Derek Reeve, Dr. Anne Jones, Dr. Chris Hunt, Professor Adrian Wood, Professor Ken Pease, and Dr. Ian Pitchford.

One cannot conclude an acknowledgement without mentioning those persons who were effected most. They are too many to mention but include work colleagues at MEPA foremost my team mainly Stephen Conchin and Ashley Farrugia, Antonello Rizzo Naudi, the University of Malta particularly the Institute of Forensic Studies Dr. Sandra Scicluna and Dr. Jacqueline Azzopardi, friends who kept putting in feedback foremost Dr. Chris Amos, Trevor Calafato, Dr. Marguerite

Camilleri and Joseph Gauci, the prison records office, the police teams, foremost Inspector Paul Caruana, WPC Priscilla Caruana and Superintendent Ray Zammit, and all those who kept up the pressure to get this study finished.

Thanks go to my family and in-laws for help in the data inputting, feedback and encouragement.

Finally, and most importantly, to the most important people in my life: my son RYAN and wife JANICE, for the ultimate in patience and keeping up with my long hours of non-existence. Ryan at age five thinks I have been playing one-fine long computer game.

To Ryan and Janice I owe all this and dedicate this work.

Saviour

## **Chapter 1: Introduction**

### **1.1 Aim of the Research**

This research aims to develop an understanding of spatial and temporal patterns of crime in a small island state and to relate the relationship between these patterns to the socio-economic and land use structures of the Maltese Islands. This analysis will help identify the relationships between crime and the social and landuse aspects. It also investigates the Island's offenders and the spatial context in which they reside as well as their offences. The study is the first of its kind in the Maltese Islands both in terms of thematic scope and in its quantitative and spatio-temporal approach.

### **1.2 Introduction to the topic**

#### 1.2.1 Synopsis

The study seeks to investigate crime patterns in the Maltese Islands over the period 1950-1999 through the use of high-end information systems, in particular geographic information systems (GIS). The study concentrates on identifying crime data sources in the Maltese Islands, creating the first datasets on crime, social and landuse issues where appropriate, geocoding-georeferencing and analysing them.

The study aims to develop an understanding of Malta's crime position in an international context. It also aims to understand the changes in crime type over time, criminal patterns in relation to the location of convicted offender habitation, reported offences and offence target categories. The study will look at transitions in crime in relation to the social and physical (landuse) aspects of the Maltese Islands, through the identification of spatio-temporal trends in crime, and where possible the relationship between them.

The investigation seeks to bring together the geographical-information and social-science disciplines to the effect that through GIS, an in-depth study can be carried out on spatial and temporal trends in crime, in relation to causal factors influencing these changes and in turn help identify areas requiring intervention.

#### 1.2.2 Theoretical Issues: Environmental Criminology

The research is based on environmental criminology theory, (also referred to as the geography of crime or the ecology of crime (Maguire *et al*, 1997)) and on the offshoots of the Chicago School, which concentrate on the study of crime in relation to spatio-temporal factors. This facilitates the



analysis of crime over space and time with specific relation to the changing socio-economic and socio-cultural scenarios. Building up on the spatio-temporal crime studies of Shaw and McKay (1942), the research initially aims to concentrate on offender location and the relationship to type of crime, as well as the physical and social parameters.

However, environmental criminology theory has moved on from the uniquely-offender studies to offence studies and during the last decades on the 20<sup>th</sup> Century has evolved to investigate the offender-offence relationship.

In view of the above, the study further investigates work carried out on offender and offence locations, mainly by revivalists of the theory (Baldwin and Bottoms, 1976), (Pyle, 1976), (Brantingham and Brantingham, 1981), (Giddens, 1984), (Bottoms and Wiles, 1986), and (Bottoms, Mawby and Xanthos, 1989). The study also looks at the offence-offender practices ordered across space and time based on available data from Censuses and other data sources (Giddens, 1984).

Being a first study of its type for the Maltese Islands, it aimed to develop a base dataset that would make possible statistical research as well as offer an archive for future study opportunities. Note is made at this stage of a dearth of any crime-related data in digital format, as well as a moratorium of 80 years on personal (prisoner) data. Though digital landuse data is quite extensive, there is very little digital social data. The study also aimed to mine, input and analyse such data and eventually convert it to spatial models. The main research areas identified above were enabled through an analysis based on several data sources. These included: police crime reports in the 1990s; convicted crime during the second half of the 20th Century particularly in relation to the residence of convicted criminals; their offences during the 1990s and; the relationship of crime to the social and landuse structures.

Further study into the distribution of crime could be based on the differences between urban and rural crime, however, since in Malta these areas are not clear-cut, an analysis was carried out based on the identification of limits-to-development<sup>1</sup> and ODZ<sup>2</sup> boundaries and the subsequent criminal patterns in both areas, referring to works by Ham (1986), Harries (1976) and Schneider (1988). This leads to detailed studies such as an analysis of crime in the urban cores that have experienced high rates of population loss and physical deterioration.

---

<sup>1</sup> Limits-to-Development boundaries were outlined in 1988 as part of the Temporary Provision Schemes as per Structure Plan development; referred to as the Urban areas.

<sup>2</sup> ODZ – Out of Development Zone area; referred to as the Rural areas.

### 1.2.3 Information Systems Issues: GIS Research Input in the Study of Crime

Until recently, most crime investigations concentrated on non-spatial sociological issues whilst some painstaking geographic research looked into specific locations but only in a descriptive way (Campbell, 1993). The advent of high-end information systems and spatial software has changed the direction that these studies are taking (Hanson and Boehnke, 1976). Environmental criminology has been brought back as a theoretical issue through the use of Geographical Information Systems (GIS), which has become one of the main means of bringing together previously disparate research analysis (Openshaw, 1993). The use of GIS together with other tools (such as SPSS, Vertical Mapper and CrimeStat), enhance analysis over more than 2 dimensions. It integrates both spatial and temporal crime, whilst linking crime statistics to such information layers as development and urban sprawl, crime hotspots, social and community facilities, locations of policing infrastructure, location of crime near bus stops, amongst others (Hirschfield, 2001; Haining, 1987; Clarke, 1995). In addition, analysis and dissemination tools such as 3-Dimensional mapping, Virtual Reality Modelling Language (VRML), and Web-mapping give access to researchers to carry out comparative spatio-temporal analysis. This said, caution must be taken to understand the limitations of such systems and methodologies (Pease K., 2001)<sup>3</sup>.

### 1.2.4 The Case for Malta in Crime

This Maltese Islands study is based on an analysis of the main data sources that were extracted from analogue records stored at diverse sources and the acquisition of other datasets. The case for Malta is established on the fact that little or no crime data existed in digital format, except for police data from 1998, no macro-study has been carried out in Malta, no spatial crime and social data exists in Malta as well as no large-scale (high detail) studies have been entertained in the two fields. In addition, there is no index of deprivation, few quantitative studies in the social field, no studies at larger-scales than NUTS 5 (mainly available at national level), and no social landuse categorisations. This list is endless, which is why this study entailed a large amount of time to find data sources, negotiate access, gather and input data, geocode it and then initiate analysis. In view of this, data made available may not reflect the same time periods for all, however, the main datasets relate of the late 1990s, with generic data going back to 1950s.

---

<sup>3</sup> Such a methodological debate is a hot topic in the CrimeMap list (15<sup>th</sup> August 2006) between the digital-leaning school Dr. Ned Levine (CrimeStat III) creator and Prof. Marcus Felson who promotes the traditional methodologies of crime analysis.

Basic raw data is of limited value; it requires processing and integrating with other data sets for scenario testing and analysis. Detailed studies in all three disciplines of crime, social and landuse aspects require extensive rethinking of the current methodologies used in the Maltese Islands. This said, integrated studies related to the crimes, social and landuse fields have also not been covered to date. This state of affairs further induced the need to create a base data model for the three disciplines to allow for future analysis opportunities.

Overall, the study serves to identify trends in the spatio-temporal offender and offence structure of the Maltese Islands in relation to the social and landuse aspects.

### **1.3 Chapter Structure**

The remainder of this Thesis is structured as follows:

#### **1.3.1 Chapter 2: Literature Review: Environmental Criminology**

Chapter 2 reviews environmental criminology literature and its attempts to explain crime in relation to the spatial dimension. This Chapter lays the groundwork by defining crime and then describes the spatio-temporal aspects in relation to the social and landuse aspects that have an impact on or are impacted by crime. A review of the history of environmental criminology is given together with a review of related theories. Crime is analysed through the duality of offender and offences interactions and how these are affected by space and time.

#### **1.3.2 Chapter 3: Research Questions**

Chapter 3 outlines the aim and objectives of this study. It gives a brief description of the objectives and how they will be achieved. A Conceptual Model is developed at this stage that looks at the process to achieve a detailed analysis of crime in the Maltese Islands through its interactions with social and landuse aspects. The process is developed through an initial abstract level structure that is further enhanced through two more increasingly-detailed levels. The latter attempt to understand the relationships between each component of the crime-social and landuse aspects, with the third level identifying datasets that are available or need to be researched in order to carry the model to its fruition. The model serves as a basis for further study beyond this research. The chapter finally lists the research questions that will be investigated in the study and those that may be investigated in future research.

### 1.3.3 Chapter 4: GIS and Crime-Mapping Review

Chapter 4 introduces the reader to GIS and how this technology can be employed in crime research. It looks at the interpretation measures taken to understand crime in a spatio-temporal construct. It introduces GIS through a socio-technic approach concentrating on the use that it could be put to, rather than just concentrating on the mere technological constructs in which it operates. A Strengths, Weaknesses, Opportunities and Threats (SWOT) analysis of GIS in terms of crime analysis is carried out based on its technical, policy-social-environmental and, marketing-economic functions. The Chapter then investigates the use of web-mapping technology and how crime statistics can be disseminated in a workable form to academics, practitioners and the general public. This investigation results in a league table of sites around the world and highlights the dearth of European and particularly Maltese sites. Finally, the Chapter serves to launch the first Maltese Crime-Mapping website.

### 1.3.4 Chapter 5: The Maltese Scenario: Setting The Scene

Chapter 5 gives an introduction to the Maltese Islands and describes a number of issues covering geographical, historical and social aspects that have shaped this island nation. It gives an in-depth exploration of the physical, socio-economic and socio-cultural profile of the Islands. This leads to a description of the third component covered in this study, that of Maltese landuse issues. Further sections in this Chapter look at the Maltese judiciary system, sentencing practice and the policing structures as well as the classifications of crime employed, in turn creating a unique classification system for the Maltese authorities.

### 1.3.5 Chapter 6: Methodology

Chapter 6 outlines the methodology employed in the study. It looks at the approaches taken, the data gathering process and the problems experienced in accessing the data. It then concentrates on the spatial concept of the study particularly the crucial geocoding process that makes the jump from tabular to spatial analysis possible. It reviews the quantitative and qualitative approaches available to crime researchers. The later sections look at the datasets available to this study, the targeted analysis techniques, and the spatial aggregation levels (from national to enumeration areas). Finally, the Chapter lays out the groundwork for the analysis sections covered in the later chapters.

### 1.3.6 Crime Analysis: Malta in an International Perspective and Generic Analysis 1950-1999

Chapter 7 begins by placing Malta into an international context in terms of its crime and then zooms in to an analysis of crime at the national level. It establishes Malta's 'position in the world of crime' through a league-table review of Malta's crime against a macro (European) and micro (Small Islands) perspectives. This approach elicits Malta's ranking in an international construct and lays the foundation for further detailed studies. Based on this statistical analysis, a relative-safety model is created placing Malta's position on that scale. The chapter then concentrates on Malta's national crime-related statistics taking a temporal approach as it analyses 50 years of crime from 1950 to 1999. It tackles this analysis through a detailed study of reported and convicted crime.

### 1.3.7 Chapter 8: Crime analysis in relation to social issues and poverty: an offender-offence approach

Chapter 8 takes a two-pronged approach, initially analysing convicted offenders' social parameters and how they relate to the environment and then reviews this relationship in an offender-offence perspective. The research reviews their temporal construct mainly how offences meriting imprisonment changed over time, the issues pertaining to residence locality, their demographic and socio-economic characteristics, the incidence of recidivism, and their crime type evolution. The study then looks at both the spatial and temporal characteristics of the offender-offence relationship during the last decade of the century. These results lead to analysis of the 1990's crime and social relationships based on a review of poverty in a spatial construct and how it relates to the offender location.

### 1.3.8 Chapter 9: Offence Analysis: 1998-2003

Chapter 9 builds on the results emanating from the offender-offence analysis in Chapter 8 and analyses the most recent incident-reports within a landuse context. The studies are carried out in a spatial construct (national to regional to local) and areas that exhibit high crime concentrations are identified and reviewed in light of their landuse component. The chapter also looks at the temporal effects of crime at the different spatial levels from national to point data and identifies areas of importance such as residential and other parameters as are social and community

facilities. It finally focuses on the commercial and recreational aspect and its relationship to crime.

### 1.3.9 Chapter 10: Conclusions

Chapter 10 brings together the results elicited in the analysis chapters and discusses them in line with the main theories outlined in the literature review. It discusses the major issues pertaining to Maltese crime and its relationship to the social and landuse issues and reviews the results in line with the conceptual model. The chapter then sets out recommendations for policy review and for further research.

## Chapter 2: Literature Review: Environmental Criminology

### 2.1 Crime: an introduction

This chapter reviews environmental criminology and its attempts to explain crime in relation to the spatial dimension. A historical review of the discipline and its related theories is given. Crime is analysed through the linkages between offender, offence and victim interactions and how these are affected by space and time. This section initially lays the groundwork by discussing different types of crime and then describes the spatio-temporal impact of crime and its relation to the social and land-use aspects.

#### 2.1.1 What defines crime?

Crime is not an easily-explainable concept. Definitions of crime differ according to the school-of-thought but the main tenets are universal. These include harm caused to victims, social consensus and official societal response (McLaughlin *et al*, 2001, 59). The sociological impact of crime is put into context by Durkheim's statement that:

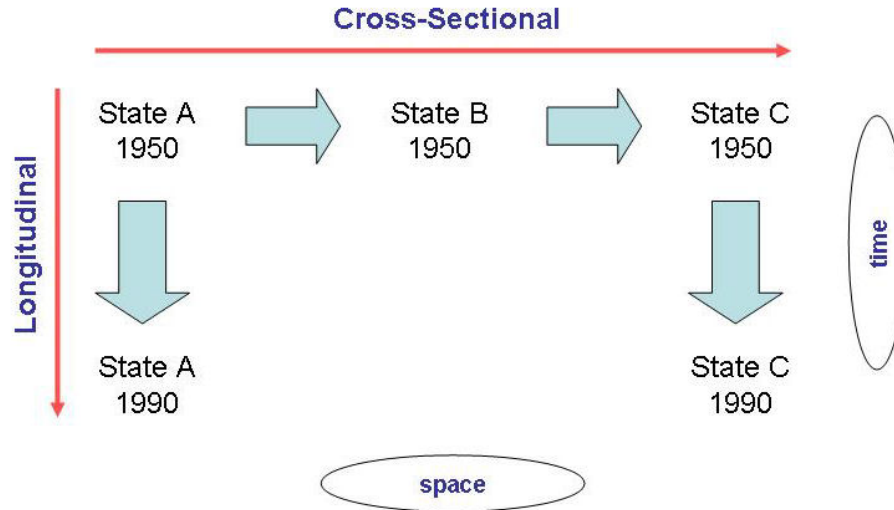
*"It is impossible for offences against the most fundamental collective sentiments to be tolerated without the disintegration of society, and it is necessary to combat them with the aid of the particularly energetic reaction which attaches to moral rules"* (Durkheim, 1933, p. 397).

The theoretical debate developed from the harm-based theory of Jeremy Bentham to Sellin's science of criminal behaviour that looked at "naturally existing conduct norms", to rule-relativist theory and radical conflict theory. Critical conflict theorists view crime in connection with an independent notion of "human rights" as against laws, which argument was further developed by postmodernists as a dynamic evaluation of harm where each case "is a moment of expression of power" (Henry *et al*, 1996, 104).

A theory posited by the rule-relativists looks at crime as "historically, temporally and culturally relative" to the social construct rather than an absolute (McLaughlin *et al*, 2001, 60). Thus, conduct that may be deemed as criminal in one state may not be deemed so in another. This situation induces the need for cross-sectional research (across space) on what is considered as crime at a particular point in time. This theory brings to the fore the temporal issue that crime changes over time as a community (state) develops where new norms and sanctions are created, inducing longitudinal research (Figure 2.1). An example would be the transition from a situation of low rates of non-serious crimes to one where serious crimes become the norm. The temporal aspect of social analysis was enhanced by the inclusion of the spatial element, moving from John

Hagan’s theory of a pyramid of crime (through the integration of the different dimensions of crime), to a ‘prism of crime’ (Henry *et al*, 1998) that attempts to cover all the theoretical elements mentioned above in one concept.

Figure 2.1: Crime changes across space (state) and time (years)



Source: The Author

### The spatial concept

The investigation of crime has also seen research into the geographic discipline. However, “for too long, geographers have observed distributions of phenomena while generally failing to draw attention to major spatial differences in a number of conditions of life of profound importance to many people” (Harries, 1974, xiii). Crime and spatial analysis were already well advanced in the 1970s but links to the social construct were needing and other concepts such as the issue of climatic impact on crime has never really taken off, though identified by Dexter as long ago as 1904 and by Cohen in 1941 (Harries, 1974).

Spatial research in crime has a long history where the earliest attempts at analysing crime through spatial patterning can be traced back to several nineteenth century innovations. In Belgium, Adolphe Quetelet (in 1835) and in France, A.M. Guerry (in 1833) made use of maps together with studies of urban-rural and crime/socio-economic conditions relationships (McLaughlin *et al*: 2001, 133). They analysed crime in relationship to location, climate, education levels, occupation and employment. In 1861, Henry Mayhew published maps of England and Wales outlining the ‘intensity of criminality’ in relation to ignorance, illegitimate children and other social issues. Figure 2.2 shows an image of the number of criminal offenders for every 10,000 persons in each county of England and Wales. The map was based on averages





Belgrade housing communities study found that crime was not clustered around the central area and that at least some of the high-rate delinquency areas were characterised by immigrant populations and ethnic diversity. During this time, centographic analysis offered hypothesis relating to changes in crime patterns and relationships between these changes and law enforcement activities (Harries, 1974: 119).

Taking these studies further, Harries looked at micro-environments stating that these can be as small as rooms, as offences have their own “ecologies of space”, as well as structural characteristics that may affect opportunity levels for particular types of crime (Harries, 1974: 78). Density is a case in point; one can study it at diverse levels, from the macro scale to the micro scale. National and regional population and housing densities as against crime signify a macro scenario, whilst the micro-scenarios may tackle such areas as the number of persons living in a block or the level of crowding such as the number of persons per room. Each level of density requires an analysis to identify the most significant correlate of crime.

### 2.1.2 Categories of crime – an international review

Researching crime at international level requires particular insight into the issue of which activities are termed as criminalised in each country in the scope of criminal law. This varies by country to the extent that comparing such figures may be infeasible or misleading. One country may gather and report crime rates that vary drastically from another, depending on what that state deems as crime. Some figures, such as those reported by the UN 7<sup>th</sup> Report on Crime Trends and Operations of Criminal Justice Systems (2003) list wide ranges from 111.5 crimes per 1000 persons in New Zealand to 0.02 per 1000 in Pakistan in 2000. Others report similar variations: the highest crime rates in the European Union are reported in Sweden with 120 per 1000 inhabitants and the lowest crime rates are found in Spain with 17 crimes per 1000 inhabitants (Entorf *et al*, 2000). The USA saw crime rates of 47 per 1000 in 1988 and Japan registered 11 per 1000 in 1991 (Schrag *et al*, 1997). Chapter 7 gives a detailed study of the international crime scenario and how Malta compares to other countries.

#### **Gender**

Crime varies across different demographic characteristics, from gender through age through race composition. As regards to gender, the involvement of males in crime outnumbers that of females (80% males - 4 in 5) in the UK<sup>4,5</sup> (Home Office Research, Development and Statistics

---

<sup>4</sup> [http://www.crimereduction.gov.uk/sta\\_index.htm](http://www.crimereduction.gov.uk/sta_index.htm)

Directorate, 2002) whilst in Germany, 19% of crimes for which a conviction had been obtained were committed by females in 1998 (United Nations, 2003). In the USA in 1998, convicted incarcerated females number 4%<sup>6</sup> of the total incarcerated persons (United Nations, 2003). Similarly, in Malta, fewer females (8% as at 1995) than males (92% as at 1995) are convicted for criminal offences (Central Office of Statistics, 1986; 1994). Chapter 8 tackles this section of study.

### **Age**

Regarding age, Wang (1999) noted that the average age of offenders is decreasing, whilst juvenile crime, white-collar crime<sup>7</sup> and violence are increasing. The age-related phenomenon peaks by the late teens, but one must note that there are underlying differences in offence types and prevalence rates that are not necessarily mirrored by consistent changes in incidence rates (Farrington, 1986). In the UK in 1999, juveniles involved in crime accounted for 10% of the general population (Home Office Research, Development and Statistics Directorate, 2002). Farrington (1987) highlights that in the US and the UK, juveniles involved in serious crimes amounts to about one third of the criminal population. Data shows that in Germany in 1996 the 14-24 year old cohort was composed of 5.7% of all the population, and accounted for 27% of all reported crime (Entorf *et al*, 2000). In the USA 17.5% of all crime in 1991 was carried out by 20-24 year olds. In Malta, juvenile crime is relatively small amounting to 0.7% (of all crimes committed) in 1986 and increasing to 1.4% in 1994 (Central Office of Statistics, 1986; 1994). Research into the phenomenon shows that criminal behaviour peaks at a young age, especially those unemployed who tend to spend more time in groups and where crime is mostly related to the travel paths of youth (Entorf *et al*, 2000). Crimes committed by juveniles are also temporary in nature and diminish by age 16, except for those who choose a criminal career (Formosa Pace, 2003).

### **Foreigners**

In addition, crime research looks at foreign nationals who make up part of the young age group (Messner *et al*, 1992). Whilst the convicted population structure in the USA in 1998 showed a 7% foreigner component, in England and Wales they totalled 0.05% (United Nations, 2003). Malta's situation has yet to be analysed, which issue is taken up in Chapter 8.

---

<sup>5</sup> <http://www.statistics.gov.uk/cci/nugget.asp?id=442>

<sup>6</sup> Data on convicted females is not available for the US, just the incarcerated convicted.

<sup>7</sup> Crime control theory posits that crimes committed by these type of offenders tend to be reduced in significance as they are seen as "one-shot criminals" who do not re-offend after their initial contact with the criminal justice system' (Weisburd, 2000). Elite crime is related to a set of macro variables such as political economy, time and the relationship between social structure and social character (Wang, 1999).

### **Dark Figure of Crime**

A large proportion of crime is not reported to the Police resulting in the realisation that absolute figures of crime will never be known. Hyatt *et al* (1999, Pg 7) indicate that less than 50% of violent crimes are reported, a figure that has stayed fairly constant over the years enabling the generation of realistic estimates of the actual incidence of serious offences. Figures have remained constant in victimisation studies conducted since 1970 in the FBI's UCR<sup>8</sup> Part I Crime US. Crimes go unreported mainly for 3 reasons (Mayhew *et al*, 1993: viii-ix): i) they are seen as too trivial by the victim even if serious; ii) questionable police response together with the intricacies of the victim-offender relationship, and; iii) the feeling that the police could not or would not want to deal with the offences. The dark figure of crime can be cause for concern considering that these types of crime are the ones victims would be expected to report, especially where repeat victimisation is concerned.

In the United Kingdom, similar research activities include the British Crime Survey, Local Crime Surveys and Longitudinal Research. The first British Crime Survey published in 1983 showed that in the case of violent crime only one in five offences were reported and one in four in the case of property loss or damage (Zedner, 1997, 580-581). Such figures lead one to query what the figures for less dangerous crimes would be.

No study on the dark figure of crime has been carried out in Malta and a sample survey was envisaged within this study to evaluate the local scenario. The rate of response was, however, too small to elicit reliable results.

### **Seriousness of crime**

Another aspect in crime analysis concerns the seriousness of crime. Seriousness is a subjective evaluation as considered by the persons living in a specific society and the phenomenon of the crimes themselves such as victim status and offender's intentions (Hembroff, 1987). One cannot simply analyse unweighted indexes for different crime types (Kwan *et al*, 2000). In a population of 100,000 persons, 100 murders should not have the same severity as 100 petty thefts. Weighted measures give consideration to the seriousness of crime type.

---

<sup>8</sup> UCR – Uniform Crime Report

Seriousness is also related to legal penalty and diverse studies have looked into the levels of seriousness (Sellin and Wolfgang, 1970; Pease, 1988). Kwan *et al* (2000) identify two approaches to depict crime based on the description of specific elements assigned to bodily harm (Sellin and Wolfgang, 1970) and crime typologies (Hansel, 1987). Kwan *et al* (2000) identify murder, rape, drug offences and robbery as the four most serious crimes in Hong Kong whilst theft, snatching, criminal damage and possession of arms as the least serious. Murder scored as much as 15 times seriousness as that of theft and the issue here would be whether this perspective is actually reflected by the legal system. The authors query whether there is a relationship between seriousness score and the relative sentencing practice, indicating the need for further research across time and in different countries.

### **Recidivism**

Another factor that concerns crime analysis involves the phenomenon of recidivism, perpetrated by persistent offenders (Moffit, 1993). Together with seriousness of crime, gauging the rate of recidivism can indicate whether a locality is experiencing specialisation in crime. Two ways to measure crime in specialisation research involve the study of repeated arrests for offending among a cohort of previously arrested offenders (Martinez, 1997) or consecutive incarceration periods for an offence where the longer the offenders stayed in the criminal field the quicker the criminal velocity between arrests became (Schwaner, 2000).

Recidivism studies need to look at number of felony convictions, age of first arrest, prior adult incarceration, number of prior paroles, as well as probationary supervision periods. Schwaner's (2000) results show that 47.5% returned to prison within a three-year follow-up period, of which 27.5% occurred due to technical reasons such as non-payment of fines, whilst 20% were new cases.

Recidivism brings with it not only repeated offences but also specialisation especially in violent crime. A recidivist has a high likelihood of committing a second violent arrest, which conviction and incarceration is predicted by a previous-like offence (Schwaner, 2000). Other issues also play a part in recidivism, such as demographic, cultural and situational structures. Studies show that there is a chronic offender population within a birth cohort (Wolfgang *et al*, 1972), within sub-cultures (Anderson, 1990) and within prison populations (Greenwood, 1982). This is related to the high probability of one's returning to the same lifestyle as that prior to incarceration since the culture has not changed much for the inmate. This is compounded by the lack of capable local guardianship within the community (Cohen and Felson, 1979). Guardianship takes various forms from familial to institutional care, though it can also refer to the immediate family. The lack of guardianship can sometimes be explained through a lack of role models in the community

who can exert control over offenders and their upbringing. However, guardianship, as defined by Cohen and Felson, refers to any situation that makes it more difficult for offenders to commit crimes without being seen and challenged by bystanders and witnesses (e.g. through good natural surveillance, CCTV systems or by residents willing to report suspicious behaviour to the police or other agencies).

The rate of imprisonment is only one of the three factors that impinge on the prison population size. The others include length of sentence and the role of remission and other executive discretions to release, such as parole (Bottomley et al, 1986:92).

Following this review of what defines crime, the next section looks at the theories that attempt to understand how and why crime occurs within the environmental criminology construct.

## **2.2 Review of environmental criminology theory**

### **2.2.1 Introduction to the theory – roots of the theory**

#### **Introduction**

The theoretical constructs discussed earlier in the chapter enabled investment into the study of crime within a spatial construct. The leap from non-spatial to spatial study lead to the conceptualization of Environmental Criminology theory which can be defined as the study of crimes based on complex relationships structured through space and place (McLaughlin *et al.*: 2001, 132). This includes the study of offender residence, offence location, offender-offence relationship and the myriad interactions between the three pivots of incidence (crime), space (relationship) and place (geographical location).

Each of these pivots are central to this research since crime in Malta has only been reviewed through its absolute levels and rarely statistically or even spatially, let alone through an investigation of the interactivity between crime, space and place. In view of this, this research took up the role to review the main theories as they apply to the Maltese context, as well as having investigated related theories that have built upon environmental criminology approaches. The study initially places emphasis on the ‘wider’ theoretical approaches such as those investigated in the early part of the 20<sup>th</sup> Century as based on offender rate analysis inclusive of residential construct as well as those taken up by revival research that has concentrated on offence rate analysis. The study then looks at the relationship between the two theoretical components through a detailed analysis of the land-use and social constructs of the Maltese Islands, basing its encompassing approach on Structuration Theory, Opportunity Theory and

Routines Activity Theory. Each of these analysis types is essential to the study in order to establish the geography of crime in the Maltese Islands. Concentrating on one theoretical approach to the exclusion of the others will not do justice to understanding what makes a small island's crime tick.

### **The Theory**

Environmental criminology is the study of crime and victimization in its relation to place and space. It is also described as 'the geography of crime and 'the ecology of crime', and attempts to develop an insight into the analysis of the relationships between place, crime and offending (Bottoms *et al*, 2001). Criminological studies have integrated the study of 'locational' crime to the activities of the individuals and organisations involved in the criminal activity, whether they are perpetrators, victims or observers.

The relationship of crime to place has been developed into one of space due to the multiple linkages making up social realities related to that place. The term spatial takes on a sociological meaning to cover crime activities in the holistic approach of what constitutes crime: why, when and where it occurs, with consideration given to the baggage that the offender carries. The spatial activities of offenders take on a new role due to the diverse links related to their activity, it is not simply a case of who commits a crime or where it occurs, but how the links enforce or make possible the activity opportunities.

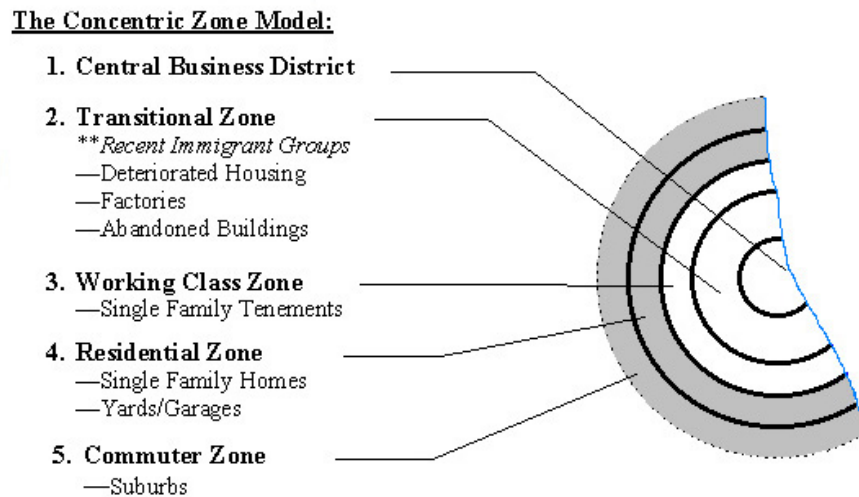
Environmental criminology takes into account the boundaries within which people act, such as work spaces, meeting-points and recreational areas. It explores the spatial concepts inherent in the wider scenario of criminal activity, such as the widening reaches of offenders due to access to new technologies and inventions (better vehicles, instant mobile communication devices), as well as 'zoning' policies instituted by planning authorities and transport. Interesting to note is the opportunity for emerging crime scenarios where offenders engage in computer crime that does not recognise any border or state, with the offender using remote technology to commit an offence from fraud to pornography.

### **Historical Development of the Theory**

The main influence for the study of environmental criminology grew from the work of the Chicago School of Sociology, with the main proponents being Shaw and McKay, and their 1930s' theory of social disorganisation. This was based on urban work by Park and Burgess in

the 1920s, who created the concept of human ecology<sup>9</sup> (Maguire *et al*, 1997; 308). Burgess's zone model of urban development conceptualised that there are five concentric zones in a city (Figure 2.3) where each zone is characterised by different types of residents who migrate away (transit) from the centre as their status improves. Over time, growing cities would engulf other peripheral towns that would become zones of transition themselves. Since urban areas contain disproportionately high rates of social problems, the larger the city the higher the concentration of poverty, welfare dependency and crime (Maguire *et al*, 1997; 308).

Figure 2.3: Park and Burgess's zone model of urban development



Source: <http://www.csiss.org/classics/content/66>

Urban ecology posits that there is a positive correlation between population density, city size and crime rates especially where population density is high and the possibility of bypassing danger is small (Messner *et al*, 1992; Entorf *et al*, 2000<sup>10</sup>). Entorf *et al* (2000) found a high association between high population density and violent crime, where an increase in one results in an increase in the other.

This is further enhanced due to the boundaries imposed by such phenomena as urban sprawl, where inelastic cities are created, that have no opportunity to keep on expanding. By the very fact that they are constrained by boundaries (such as sea, peninsulas, etc) they end up being even more segregated and higher degrees of poverty flourish (Shaw-Taylor, 1998). “A high number of persons per room would lead to “irritable, weary, harassed, inefficient” parents, a repulsive

<sup>9</sup> Human Ecology is derived from the botanical sub-discipline of plant ecology. The concept was based on the analysis of the spatial and temporal relations of human beings, by the selective, distributive and accommodative forces of the environment (Maguire, 1997; 308). The theory was also called the ‘ecology of crime’ due to the relationship between crime and the urban environment.

<sup>10</sup> cf Bundeskriminalamt, Polizeiliche Kriminalstatistik (various issues, 1975-1996), Wiesbaden, Germany



environment for children, and a consequently high level of juvenile autonomy, which in turn contributes to the development of gangs of delinquents” (Galle et al, 1972: 85; Harries K.D., 1974).

Wang (1999), on the other hand postulates that the shrinking living space in urban areas in effect reduces crime rates, stating that this could be due to the proximity of people to each other. Wang posits that an increasing population density is directly related to crime reduction. However, this may also increase the possibility of unknown crime as well as the ‘dark figure of crime’. These two opinions seem contradictory but are a source of debate on the possible outcome for future mega-cities and what they are expected to experience. Further study is needed in this area especially on population density and the relationship to crime. This is particularly due to the fact that areas with a high population density offer a higher concentration of crime opportunities and effectively higher potential crime targets (people and property).

### **The Next Steps**

The early 1920s research led to a number of theories, namely the ‘Culture Conflict Theory’ of Sellin in the late 1930s and Sutherland’s ‘Theory of Differential Association’ (Maguire, 1997: 308). Sellin, followed by Vold, Dahrendorf and Turk based their theories on the issue of diversity in an industrialised society<sup>11</sup>. Such diversity causes conflict to materialise moving though such constructs as conduct norms required from citizens coming into conflict with the prevalent crime norms. Dahrendorf’s move from a Marxist concept of **material** haves-haves-not to **power** haves-haves-nots easily highlights the realities of society, based on the power-holding/hoarding elite and the powerless masses. Sutherland stated that through social interactionism, offenders learn favourable definitions through mixing with others who find lawbreaking acceptable (Hochstetler A., 2002). However, the main impact was produced by Shaw and McKay since their research concentrated on the analysis of Chicagoan juvenile crime in the early 1930s through the mapping of offender residences at different points in time.

The Chicago researchers ventured further than just spatially analysing the offender community through a quantitative study. They also looked into the social aspect of the offenders and what was termed ‘low life’ in the cities. The second aspect of the study concentrated on qualitative case studies and life histories. They managed to bring together these two diverse methodologies as well as integrating the new concept of spatial analysis in crime.

---

<sup>11</sup> <http://www.umsl.edu/~rkeel/200/culfflic.html>

Shaw and MacKay (1942) identified the existence of delinquent subcultures, which adhere to a set of norms relative to that subculture. Shaw and McKay noted that the cultural heterogeneity and constant population movements in 'zones in transition' influenced delinquency through a process termed 'social disorganization'. They tried to decipher how the conventional value systems may not adhere to all the units within the same entity, mainly where there was a lack of structurally located social-bonds that encourage legitimate and discourage illegitimate behaviour. Where these norms break down, disorganisation occurs.

This social disorganisation process occurs mainly through the concentration of persons who are liable to offend in specific areas of a city or town with a high degree of illegitimate enterprises and immoral worlds (Finestone, 1976). In this situation, the structure of the locality starts to deteriorate due to incapacity of the traditional institutions to maintain control and solidarity. These institutions include the family, the church and the local community. Due to lack of common and non-delinquent values, the areas in question become hotspots for crime.

The central discoveries emanating from Shaw and McKay's research was based on three concepts (Finestone, 1976: 25):

- *rates of juvenile delinquency conformed to a regular spatial pattern, higher in the middle zones and tended to decline with distance from the centre of the city.*
- *the same spatial pattern was shown by many other indices of social problems in the city.*
- *the spatial pattern of rates of delinquency showed considerable long-term stability, even though the nationality makeup of the population in the inner-city areas changed from decade to decade.*

The theory of social disorganisation has had both attractors and detractors, the former due to its solidity in relation to the offender aspect of the theory, whilst detractors criticised the fact that crime may not only be a case of disorganisation, but may be a case of organisation (Whyte, 1943 in Bottoms and Wiles, 2001). An organisation may offer social capital<sup>12</sup> to its members but disrupt the social cohesion<sup>13</sup> of the area it operates in (Kawachi *et al*, 1999). As an example, one can take the case of the Mafia, which is a very organised structure both in the USA, China, Albania, and Sicily and is emergent in countries such as Taiwan (Snodgrass, 1976; Wang, 1999).

---

<sup>12</sup> Social Capital: "Those features of social organisation, such as networks, norms of reciprocity, and trust in others, that facilitate cooperation between citizens for mutual benefit" (Coleman, 1990; Putnam, 1993; Sampson, 1995)

<sup>13</sup> Social Cohesion: the process describing "communities with high stocks of social capital and low social disorganisation" (Wilkinson, 1996; Kawachi and Kennedy, 1997; Sampson *et al*, 1997)

Matza (1964) claimed that the social disorganisation theory is over-deterministic and over-predictive. There were few developments in this area of study following a peak in interest in the period between the two world wars.

### 2.2.2 From the Chicago School to revival research

Following on the work by Park and Burgess, and, Shaw and McKay, other researchers such as Tibbits, McKenzie, Anderson, Wirth, and Zorbaugh collectively developed the first large-scale theoretical approach to the study of the nature of crime and American urbanism, an approach that was spatial as well as sociological (Georges-Abeyie *et al*, 1980: 1). The developments over the decades lead to the development of crime pattern theory that looks at both the established and changing nature of crime. Crime patterns can only happen due to the constructs that make them, inclusive of the location they occur in, and the sociological and psychological relationships to space. Heal (2001, 268) states that the imposition of crime pattern analysis on recorded crime statistics helped researchers to make a leap towards understanding crime and space and well as fill in information gaps. He states that the early 1980s' work enabled the development of crime pattern analysis, however the main limitations were those imposed by small samples and observed pattern reliability and stability. This also included limited attempts to analyse crime patterns with socio-demographic data. Over the last decade these issues have been resolved or facilitated through the use of widely-available datasets and spatio-statistical software.

Other researchers covered different socio-economic/socio-cultural aspects. Schmid (1960) identified 6 types of hypothesis that could be used to account for patterns of crime. These were: i) the "ecological segregation/contingent control" hypothesis where high frequencies of crime reflect opportunities, ii) the "drift" hypothesis - certain areas attract offenders, iii) the "differential association/cultural transmission" hypothesis - areas characterised by distinct sub-cultural patterns of delinquency and crime, iv) the "social alienation" hypothesis - areas characterised by social problems, v) the "anomie" hypothesis - delinquency is a disruption of the collective order, and v) the "illegitimate means/differential opportunities" hypothesis - differentials in access to illegitimate means.

Other sociological theories on delinquency areas are based on a threefold structure (Gill, 1977): i) the "ecological approach" investigating why people live where they do, ii) the "sub-cultural approach" that analysis how localised and distinctive life styles exist, and iii) the "social reaction approach" that highlights how labels are given to individuals and areas.

Practical problems exist where the question of the ecological fallacy arises<sup>14</sup>. This is the erroneous assumption that an overlap of problems at an area level (e.g. high levels of criminal victimization and high unemployment) also occurs at the level of the individual household (e.g. all victims of crime are unemployed). The relationship between victimization and unemployment can only be revealed through surveys that record the employment status of victims of crime.

Early environmental criminology studies suffered from this fallacy which assumed that “*the descriptive characteristics of areas having high proportions of offenders resident identified both areas where crime control programs should be undertaken, and the individuals who were likely to commit crimes*” (Brantingham *et al*, 1981:17)<sup>15</sup>. Every area hosts non-delinquents though studies concentrate on the delinquents rather than the whole. An area hosting delinquent residents has a good chance of being stigmatised and labelled. Mays (1963) argues that whilst there would still be significant numbers of persons who would not be offenders, but there are sufficient numbers who are criminal, then that area as a whole could be termed as “delinquency producing”. Where crime rates are high, potential offenders realise that foregoing an opportunity means that someone else will take it whilst the fact that they act may make them heroes in their community as a sort of badge of honour (Schrag *et al*, 1997). Some offenders anticipate arrest even if they do not commit a crime, thus the incentive is doubly attractive, further stigmatising an area.

Dunn (1980) looks at the association of land use with offence occurrence and offender residence areas, in line with Shaw’s (1929) study of delinquency areas. He states that “crime... consists of a complex set of transactions of individuals with their environments ... which vary in setting, time, objects, participants and activities” (Dunn, 1980). He identifies four ways to look at in the study of crime and land use: i) offence location crime in urban places, ii) areas with commercial activity and high-density residential development in poor condition, iii) quality of residential land use (substandard housing), and iv) land uses related to specific offences, due to different targets reflecting the area function or structure. This study tackles such issues in Chapter 9.

McLaughlin (2001: 133) identified four new spatial approaches to the topic: i) mainly the spatial distribution of crime, ii) risk of crime victimisation in space, iii) spatialised fear of crime and iv) particular crime flows from one area to another.

---

<sup>14</sup> “Robinson (1950) was one of the many critics of social disorganization theory, and his article pointed out the problematic nature of making individual-level inferences on the basis of aggregate data.” - <http://faculty.nwc.edu/toconnor/301/301lect08.htm> - Lectures in Social Disorganization Theories Of Crime

<sup>15</sup> In Malta, an Ecological Fallacy would serve such statements as stating that Libyans commit more crime as they reside in a small area in Bugibba when in fact an analysis of individual basis (eg crime rate per 100,000 for Libyans as against for Maltese) may show otherwise.

Giddens's theory of Structuration (Giddens, 1984) has again brought to the fore the agenda that sociological studies must be based on the analysis of 'social practices ordered across space and time', which theory reflects the take-off point of the Chicagoan School. Bottoms and Wiles (1997) have taken up the concepts of space and time as the major point of departure for environmental criminology studies, stating that Giddens' concept is central to its theoretical base. They bring as evidence his explanations on humans as knowledgeable agents, practical consciousness, his move away from the traditional dualism of objectivism and subjectivism, the duality of structures as both motivators and constraining agents, as well as the importance of routine activity. Structures result in a practical consciousness that is able to follow regular patterns in space and time. One needs to understand how place, over time, is part of the practical consciousness of social actors who engage in behaviour, including actions defined as criminal (Bottoms and Wiles, 2001: 19).

### 2.2.3 Pivots of crime

The offender residence perspective allows researchers to analyse patterns in residence preference, areas that are more attractive to offenders based on their particular norms and values. An analysis of the diverse social variables would describe the activities that offenders partake in at individual, co-familial and community-career levels.

Following the relative superiority of Shaw and McKay's theory, there was a lull of fifty years in spatio-temporal crime analysis until the 1970s when a revival of interest occurred from another aspect: offence distribution. Shaw and McKay's work had concentrated on offenders and their life-histories as well as the relationship of their offences to the place<sup>16</sup> they reside in.

The refocusing of the theory indicated that there is a difference between offender residence and offence locations. Offenders aggregate in specific residential areas for social, economic and cultural reasons. Squatting possibilities, vacant housing in stigmatised areas, little financial clout to move to better areas are but a few examples. On the other hand, offence areas posit other scenarios. They could be either the same areas of residence, areas in the vicinity of the offender's day-to-day activities, areas of recreation and well as opportunity-presenting areas.

The 1970s research introduced studies on 'defensible space' (Newman, 1973) and on the constitution of crime: mainly the law, offender, target and place of crime (Brantingham *et al*, 1981). However, they were criticized as they left out the basic tenet of Shaw and McKay's effort:

---

<sup>16</sup> Sociological concept of place: the social organisation of behaviour at a geographical place (Bottoms and Wiles, 2001)

the offender's residence. This said, they do state that movements bring offenders and their targets together (Bottoms and Wiles, 1997).

Shaw and McKay's theory of concentric ring zonal distribution of crime was challenged both outside the USA and in Chicago itself after World War II (Taub *et al*, (1984) in Bottoms and Wiles, 1997:331; Bursik (1986) in Bottoms and Wiles, 1997:331). The 'old areal regularities broke down' and the 'theory of concentric rings was discarded together with the formulation of urban process that went with it' (Bottoms and Wiles, 1997: 331). One has to note however, that Shaw and McKay's theory of Social Disorganisation is still supported.

The new surge of research in the 1980s and 1990s identified a number of issues that showed variations from the classical circular concentric zone theory. These variations may have been due to the fact that European urban areas such as Croydon in London (Morris, 1957 in Bottoms and Wiles, 1997, 312) and Sheffield (Baldwin and Bottoms, 1976 in Bottoms and Wiles, 1997, 312) were built for different purposes, with the higher status areas concentrated around the city-centre and in other formations that do not conform to the Chicagoan model where the centre was industrialised.

Generally the contrast is between cities such as Paris and Glasgow that have disadvantaged areas on their periphery and those that confirm to the Anglo-American pattern (e.g. London, Chicago, and Los Angeles) where deprivation is in the inner cities and affluence is in the suburbs.

Recent studies have focused on the housing market and came up with an analysis of the direct and indirect consequences of the operation of the market on crime. A study in Sheffield in the late 1960s (Rex and Moore, 1967) launched a series of studies in the field that brought up new concerns on how the modern industrial situation affects the crime patterns in both rust-belt and sunrise cities (Craglia *et al*, 2000). Industry is becoming dispersed and less zonal and is challenging the concentric-ring theory (Harries *et al*, 1998), especially where the dispersion could be effective in reducing crime (Wang, 1999). Studies are needed in the latter to identify if dispersing industry actually results in reducing crime or else in dispersing it over a wider area.

Harris *et al* (1998: 623) state that the zonal model had two major faults. One was that the divisions were based on the social, political and economic fault zone between the city and suburbs. The other fault was that the zonal model misrepresented Burgess's model and the cities and suburbs of his day. Hoyt (1939 cf Harries *et al*, 1998) indicated that single family units lived in the periphery and in the suburbs, whether the latter were industrial or residential. They did this based on their consumption patterns (Douglass, 1925 cf Harries *et al*, 1998).

Another input to the theory looked at the housing market which is intrinsically linked to offender rates. As dwellings are occupied according to the residents' income, households of similar status tend to group together. Higher status groups tend to segregate themselves into small close-knit areas and try to keep other categories from moving in, whilst lower status groups tend to be dispersed (Ladanyi, 2001). In his 1979 group status analysis of prisoners in Budapest, Ladanyi identified that inequality changes with time and new forms of crime manifest themselves to reflect structural changes. In this study, areas zoned for agriculture and industry showed high offender rates as against the highest status parts of the city exhibiting very low proportions of detected and convicted offenders.

The higher-status segregation makes it difficult to separate social class from area of residence (Pain, 1997). This is also marked where the middle class is conscious of being suburban and aggregates around the city periphery (Singleton, 1973). Where middle class values start to decline, a high incidence of delinquency and crime in urban settings is linked to the loss of social buffers (Kawachi *et al*, 1999). Schnore (1963 in Harris *et al*, 1998) claimed that income, education and occupational standing increased in proportion to distance from the urban conglomeration, moving out from inner poverty city centres to outer affluence (Jackson, 1985). An increase in delinquency is found in the population of low-income earners, the elderly and poorly educated people demanding additional social services (Goldfield *et al*, 1979 IN Harries *et al*, 1998).

#### 2.2.4 Offenders and Offences

##### **Offender Rates: An Analysis**

The offender analysis looks at the crimes committed by an offender based on his/her location of residence and role in crime. Whilst crime analysis concentrated on community studies between the 1920s and 1940s through work carried out in Chicago by Shaw and McKay, the emphasis slowly changed to an analysis of individual behaviour. This has been recently revived by looking out for the "criminal careers" of communities that could enhance the understanding of crime and its causes (Reiss, 1986). Just as one describes individual offender crime careers, Reiss (1986) argues that one could extend this concept to the communities that experience changes, through analytic studies of both offender rates and offence rates (Schuerman and Kobrin, 1986; Bottoms and Wiles, 1986, 1992; Bottoms, Claytor and Wiles, 1992).

## Residential Issues and Offenders

The local housing market came into focus through such work as Rex and Moore's (1967) Sheffield study where they analysed housing patterns through a Census Enumeration District analysis. The results showed that there was a correlation of housing type with offender rates (Baldwin and Bottoms, 1976). Major variations occurred within the areas with a predominant housing type, which was further analysed to reveal that it is different from the Chicago study; there was no relationship between the rate of tenant turnover on estates and offender rates (Baldwin and Bottoms, 1976). This study and another conducted by Wikstrom in 1991 in Stockholm (Wikstrom, 1991) indicated that the studies went beyond a simple social-class analysis since they included such external elements as landuse. Wikstrom's Stockholm path-model approach hypothesised that housing tenure variables would feed through to population composition variables: in effect half the area offender rates variation in several districts was explained by housing type and social composition. This created a further inroad into the study of offenders and the locality they reside in<sup>17</sup>.

Schuerman and Kobrin (1986) looked at the physical makeup of the locality and the shifts in land-use, particularly the housing sector, as well as demographic changes, mainly in household and absolute population structure. They argue that even small changes in land-use can bring about a change in population structures, implying that an increase or decrease in the real-estate purchases or renting could change the framework of operation in a spatial area. The same changes reflect who enters or exits the locality and in turn changes the offender/offence relationships related to that area. An increasingly degraded area would result in a reduction of rents and an influx of low-income earners effectively changing the make-up of that community (Ellul, 2003).

A classic example assessing the different types of dwelling zones was based on the analysis of two towns for three categories of housing: low-rise council, high rise-council, and privately rented areas. The classic study was the "Stonewall and Gardenia" housing estates in Sheffield case study (low-rise council) where Gardenia had 'tipped' in the 1940s. Once 'tipped' it continued to attract categories of persons who were prone to offending due to the allocation of homes to such persons. There were also indications that the negative reputation of this town

---

<sup>17</sup> This situation can be tackled in a number of ways. One study carried out in Public Housing Authorities in the USA (Hyatt *et al*, 1999: 18) looked at the housing setup within the authorities' jurisdictions and carried out concentric ring analysis based on a series of six 50m interval buffer zones. They introduced a new factor called blockface analysis where crimes occurring in areas facing the authority boundaries are also analysed. The theory assumes that crime does not stop abruptly around these housing areas but continues further away from the immediate boundary area.

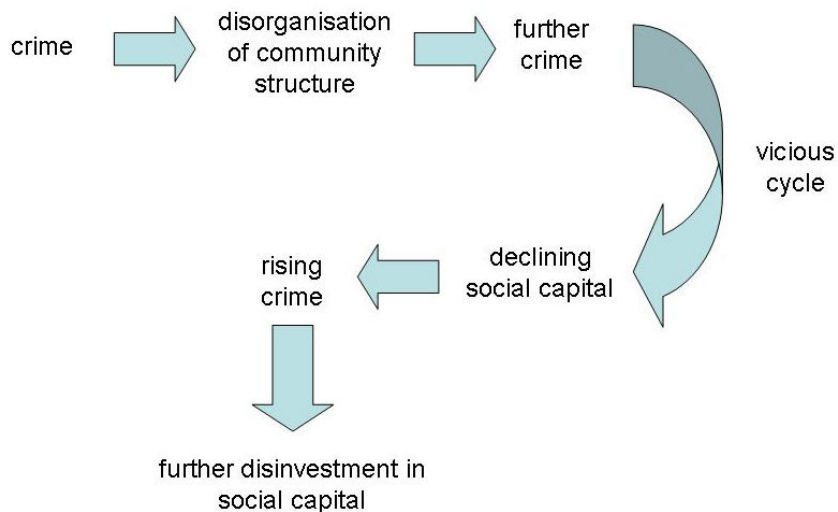


created an effect on its residents, schools and networks. Stonewall did not go through the same changes and retained its crime-free structure (Bottoms, Mawby and Xanthos, 1989).

Neighbourhoods 'tip' towards crime through a process described by the 'broken windows hypothesis' where a locality's crime status deteriorates over time (Wilson and Kelling, 1982). The components keeping an area together include the offender's role, power with respect to crime by others, and the extent of the criminalisable space (Van der Wurff *et al*, 1989: 144-145). The rate of change of signs of disorder (broken windows, housing abandonment, litter and graffiti) is relative to the process where the community loses control. Once the community abandons control, vandalism occurs and an unintended invitation is given to persons involved in the crime trade to move in. Skogan (1986, 1990) investigated this decay and called it the 'spiral of decay in American Neighbourhoods', where the physical (abandoned or ill-kept buildings, etc) and social constructs (public drinking, prostitution, etc) are strongly correlated.

The fear of offenders leads to a vicious cycle until no investment in social capital occurs through withdrawal from community life, out-migration, loss of jobs, loss of networks, fewer opportunities for network and social organisations and exit of businesses (Figure 2.4) (Kawachi *et al*, 1999; Farrall *et al*, 2000). This effectively results in a perpetuating situation of decay and where such areas remain disorganised for long decades.

Figure 2.4: Kawachi et al's description of the Social Capital Disinvestment



Source: Adapted from Kawachi *et al*, 1999, pg 727

## **Offence Rates: an analysis**

Offence-location research provides valuable data on the patterns of crime by type, time, and location but also poses a problem of relationship. How does one equate the issue of offences with the area in question as well as the offender committing the crime?

There are various issues at stake in offence analysis, particularly due to its complex structure of what classifies an area as a crime attractor or crime generator which issues are investigated in chapter 9 of this study. Offences occur due to the intrinsic relationships between the offender and the offence: is it a crime of chance or a crime of choice? Does an offender choose to carry out an offence in an area because of its affluence (such as a villa area) or because of its inherent social structure such as that where there is no social cohesion and social capital?. Crime attractors offer high-level visual, psychological and sociological imperatives to offenders to commit crime therein such as opportunities provided by sparsely-populated residential areas. On the other hand crime-generators may be a result of land-use designation such as in recreational areas that provide easy-target opportunities such as vehicles, highly-dense patron-packed bars. Irrespective of the type of crime-function, the offender has a role to play, mainly due to his/her modus operandi and the relationship to the crime target, whether kick-started through routine activity, or specific target hot-spotting. The research questions investigated in chapters 8 and 9 specifically target areas within the Maltese Islands in order to investigate their potential as attractors or generators of crime.

In order to identify specific issues that help offenders to operate within the attractor-generators pivot, in-dept studies are required such as those reviewed in Stockholm by Wikstrom (1991) and in Germany by Entorf *et al* (2000).

Per-Olaf Wikstrom in a study of offences in Stockholm in 1991 (Wikstrom, 1991), considered the fact that the measurement of areal offence rates poses quite a problem due to the use of resident population as a denominator (Harries, 1981). Stating that crime in a historic town is related to the number of its residents is erroneous especially where most crime results from theft of for example cars in car-parks reserved for tourists visiting that area.

Wikstrom (1991) was building on a study in Sheffield where crime in traditional cities tends to concentrate around the centre of the city, particularly for violence in public, vandalism in public, and theft of and from cars. Bottoms and Wiles (1991) stress that though this is the case in most

cities; one has to keep an open mind that changes in land-use could bring about changes in the distribution of these offences. Through his study Wikstrom showed that residential burglaries tend to occur in areas of high socio-economic status, especially those that are nearby to areas with high offender rates. He indicated that there are specific geographical skews in the patterning of offence locations and that these can vary significantly by type of offence.

High income was found to be positively correlated to crime rates in Germany, indicating that richer persons are better targets (Entorf *et al*, 2000). This is due to the higher incentives that persons living in disadvantaged areas have (Kosbela and Viren, 1997). The higher the income inequality the worse the legal income opportunities become and in turn better illegal income opportunities are sought.

### **Can one be studied to the exclusion of the other?**

The last two decades of the twentieth century brought the offender and offence-based theories together. Though both can be studied in isolation, the main progress being carried out by contemporary criminology is the study of this relationship.

Such a process of understanding both offender and offence relationships can be strengthened through a review of the related theories of Structuration, Opportunity and Routine Activity.

## **2.3 Related Theories**

### **2.3.1 Structuration Theory**

There are various theories of crime that have attempted to call themselves general theories of crime. Few have managed to integrate the issues of crime with the issue of space. For example those of Braithwaite (1989) and Gottfredson *et al* (1990) rarely cover the issue of spatiality, concentrating on issues such as social control (cf Bottoms and Wiles, 2001 IN Evans *et al* 2001: 12). One of the closest approaches to an integrated approach to Environmental Criminology is Structuration Theory proposed by Giddens. It is also a popular debating issue between human geographers and social theorists (Gregory and Urry, 1985).

Environmental criminology studies have not always looked at the collective study of offence and offender rates. Each has been researched to the exclusion of the other. The Chicago School concentrated on offender studies whilst others (Newman, 1972) have focused on offences. Giddens went beyond the classic theories as posited by the founding fathers of sociology and

argued that these two tenets cannot be and must not be studied in isolation, rather they have to be considered as inseparable (Giddens, 1984: 2). For him societal change can only occur as 'social practices ordered across space and time' which evolve through the activities of human beings as knowledgeable agents acting in the context of social life. He also looks at structures and how they exist within, constrain and enable social actions as well as the issues of routine activity, social change and social processes.

Giddens based his analysis of the routinised character of daily-life space-time on Hagerstrand's concept of time-geography (Giddens, 1984: 111). Hagerstrand had analysed movements of individuals in a local parish in Sweden over their lifespan and composed time-space analysis through charting their movements. The issue deriving from these movements indicate that there may be patterns to the way people conduct their lives and this includes offenders in their relationship to the offence location. Carlstein (Giddens, 1984: 116) indicated that these 'ecological constraints' derive from specific modes of 'packing', mainly the packing in small areas of materials, artefacts, organisms, and human population in settlement time-space, and their activities in the related space. This results in a 'clustering of institutions' across time and space, giving rise to offender locations that may not be desirable to reside in and offence locations that are attractive to offend in (Giddens, 1984: 164).

Structuration theory in effect offers an understanding of the ongoing processes of interaction between the elements making up a crime. Any model of crime analysis should look at these in an understanding of the spatial aspects of offending and offences and their relationship.

### 2.3.3 Opportunity theory and Routines Activity Theory

Offenders commit crime for a variety of reasons, varying from the need to survive to taking advantage of opportunities that present themselves. Two theories that investigate these reasons are Opportunity Theory (Bursik and Grasmick, 1993; Felson and Clark, 1998), and Routine Activities Theory (Cohen and Felson, 1979; Ekblom, 2001). Each fits in with environmental criminology theory in that the fundamental issue at stake is space: where does an opportunity present itself and how does one get to make use of an opportunity and act accordingly, if not through the familiarity of the spaces inherent in his/her cognitive mindmap?

Opportunity Theory looks at crime from the point of view of the offender: the opportunity to carry out an offence and; the level of target attractiveness of the area. Such issues posit fundamental questions, especially in determining what a researcher must look for in determining attractors. When does a car become enough of an attraction to steal and for what purpose?

An offender looking for a car for 'mere use'<sup>18</sup> may not be attracted by a specific make of car, but a car thief looking for a lucrative catch may visit areas of high affluence.

Another aspect that makes an area attractive relates to the accessibility of the location. The accessibility issue leans on four parameters; visibility, ease of physical access, the absence of adequate surveillance and, the modus operandi of the target. Areas within easy reach of transport routes would pose a hazard for residents due to the opportunity offered (Mayhew, 1976). Brantingham and Brantingham (1984) further argue that all individuals carry in them a cognitive map of the city and engage in search patterns to identify areas of interest. Bottomley *et al* (1986) state that it is difficult to decipher whether the increase in the number of crimes is due to the form of increased opportunities such as the car or a decline in respect for property.

Accessibility becomes an issue due to the offender's knowledge of both the real physical and cognitive space (Beavon *et al*, 1994). Potential offenders will not offend in previously unknown areas but where criminal opportunities intersect with their cognitively known areas (Bottoms and Wiles, 1997: 324). Rengert (1980: 21) adds that 'the relative magnitude of an opportunity is proportional to its relative degree of accessibility which will partially determine its probability of being exploited'. This indicates that even though an area may be affluent or has commercial aspects that could prove lucrative to a potential offender; its accessibility plays a major part in the commissioning of an offence. Also, a high-attraction area (such as a secluded villa area) that has few visible people tends to suffer more crime since there would be fewer witnesses (Jacobs, 1961).

Newman (1972) argued that the solution to this situation would be the creation of territorial subdivision, whether conscious or unconscious, to identify outsiders. This occurs where residences along less accessible streets are not familiar to non-resident criminals and so will experience less burglary episodes (Bevis and Nutter, 1977).

Further developing this area of research within the domain of situational crime prevention, Felson and Clarke (1998: 9) posited their ten 'principles of crime opportunity theory' which outline those issues that can be considered as the 'root causes of crime' as well as leading towards reduction measures:

1. Opportunities play a role in causing all crime
2. Crime opportunities are highly specific
3. Crime opportunities are concentrated in time and space

---

<sup>18</sup> Such as joy-riding

4. Crime opportunities depend on everyday movements
5. One crime produces opportunities for another
6. Some products offer more tempting crime opportunities
7. Social and technological changes produce new crime opportunities
8. Opportunities for crime can be reduced
9. Reducing opportunities does not usually displace crime
10. Focussed opportunity reduction can produce wider declines in crime

*Source: Cohen and Felson, 1998, pg 9*

Opportunity Theory has its own sister theory entitled Routine Activities Theory which looks at the day-to-day activities of victims and offenders in relation to the location and timing of offences. Crime is closely related to the offenders' activities as well as the activities of potential victims. New opportunities offer themselves, such as attacks on the elderly. Perceived high standards of living produce an opportunity to those who normally act around a few spatial locations either as part of their day-to-day activities such as a work transport route. The mere fact that an action is a routine activity implies that there is an element of social activity – there is an interaction that is being portrayed (Cohen and Felson, 1979). Furthering this concept, Felson and Clarke (1998) highlight the fact that there is a veritable target (as preferred over victim's) role in creating opportunity through their VIVA model (value, inertia, visibility and access).

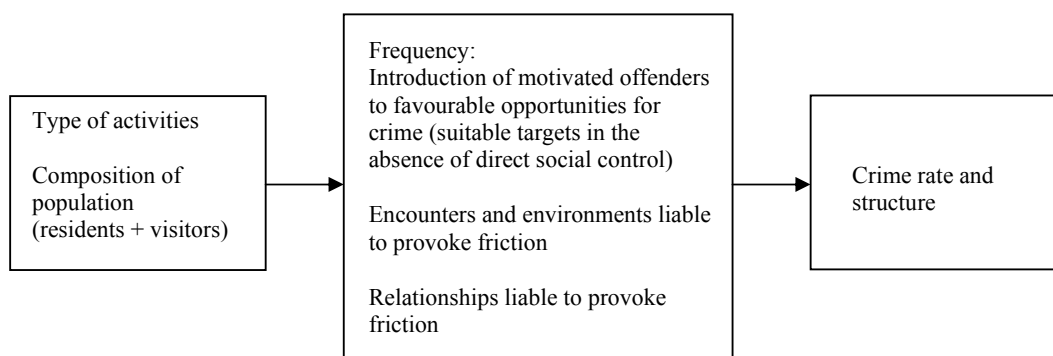
These routine daily activities fit into the framework set up by Giddens in his theory of Structuration, due to the fact that the social action being interpreted needs a human being who relates repeatedly to a social structure in a particular place (Giddens, 1984: 110). His concept of 'locale' looks at a wider aspect than just place, integrating the interactions occurring therein. An analysis of crime in particular areas (by type of crime and activity in that area, for example retail) may bring up specific time-periods when offences occur. "The probability that a violation will occur at any specific time and place might be taken as a function of the convergence of likely offenders and suitable targets in the absence of capable guardians' (Cohen and Felson, 1979).

Such a description helps to counter the preoccupation that studies such as the Minneapolis study conducted by Sherman *et al* (1989) queried when they posited that 'places cause crime' as they are criminogenic generators of crime. This is different to the concept that places host crime (serving as attractive receptors of crime) due to the interaction of a routine activity by a potential offender and that same place. The fact that persons go to have a 'good time' in recreational places does not mean that the area creates a potential murder, since the interactions of the offender and victim could have occurred anywhere (Karlsson, 1998).

Wikstrom's approach is a combination of opportunity and routine activity theory where he introduced the concept of time-crime. He states that the inner-urban activities fluctuate over time and space to the extent that different times of the day experience different activity types and frequencies as reflected in Figure 2.5 (Wikstrom, 1990: 23).

Each of these components can only be studied by understanding the localities they occur in: the physical structure and the prevailing social issues that term an activity as a crime.

*Figure 2.5: Wikstrom's model of variations in and types of crime in the urban environment*



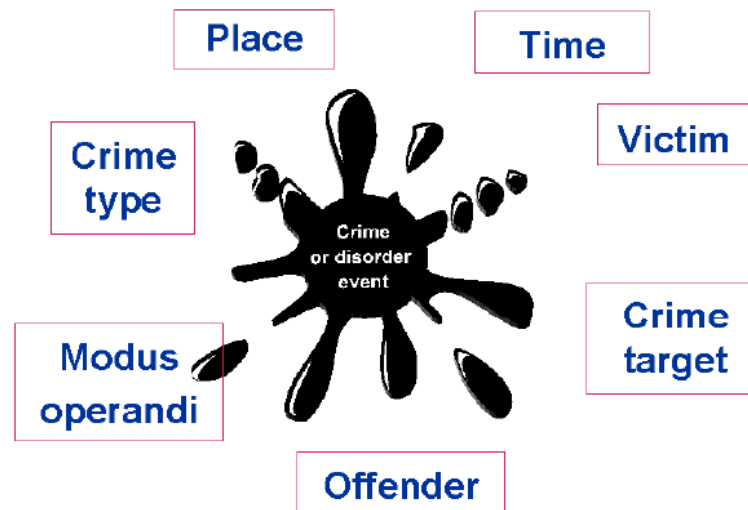
Source: Wikstrom, 1990: 24 IN Bottoms and Wiles, 1997:328

When reviewing the various pivots of crime from either an opportunity or routine viewpoint together with the social structure it occurs in, Ekblom's (2001) Conjunction of Criminal Opportunity theory provides a unified approach towards what is eventually the main aim of criminological research: prevention and reduction of crime as well as promoting to the fore community safety (Figure 2.6). Its target is the identification of all the issues that occur at a specific point in time which make criminal occurrence happen. This leads to action on assessing risk of crime (prevention), actively aiming to reduce (number and seriousness) as well as enhancing social activities through quality of life and improved state of existence.

In effect, Ekblom outlines a strategy that ropes in the main tenets of opportunity theory, routine activity theory as well as Structuration aimed at developing preventive strategies that have an impact on the ground through such actions as that outlined in his CLAMED model. The latter model takes on the role of task **Clarification**, preventive agent **Locating** hence **Alerting** them to the crime problem whilst **Motivating** them to take on the crime reduction task, at the same time **Empowering** and **Directing** them to take on capacity issues and to follow guidelines, select targets or implement particular activities. The latest update to the implementation of the theory is

the 5Is<sup>19</sup> initiative (Intelligence, Intervention, Implementation, Involvement (of the community) and Impact).

Figure 2.6: Ekblom's Problem Space: A Map of Symptoms and Crime Reduction Objectives



Source: Ekblom (2001), pg 20

In conclusion, the review of the main theories that have promoted environmental criminology to its current status has shown that in its ultimate stage, crime can be analysed in its spatio-temporal constructs and based on the findings strategies can be implemented to impact and reduce crime occurrences.

## 2.4 Physical and Social issues

Environmental criminology research with its related theories and components as described above would be bare without a review of two main related components: land use and social issues. Each places an impact into the analysis of what constitutes the environment and how crime interacts with each.

### 2.4.1 Land-use component

The relationship of crime and landuse has been recognised since the thirteenth (13<sup>th</sup>) Century when Edward I tried to control crime by introducing the Statute of Winchester in 1285. This Statute covered instructions on the communities' obligations with regard to possession of weapons and to maintenance of the King's peace (Summerson, 1992). UK street widening in the

<sup>19</sup> <http://www.crimereduction.gov.uk/learningzone/5isintro.htm>



nineteenth century lead to the dispersion of concentrated criminal elements (Beavon et al, 1994). In more recent post-war times, urban development was based on the automobile and mass transportation that led to changes in opportunities for crime due to the concentration of people in specific areas. As an example, arresting an offender committing snatch and grabs in the vicinity of subway exit-points would be very difficult to conclude as it provides a number of escape routes (Brantingham *et al*, 1984).

Urban planning and the subsequent impact on crime were brought to focus in the quest for 'livable streets' (Appleyard, 1981). Like the theory of social disorganisation before it, the analysis of street systems and their associated land-uses was shelved for over half a century but new studies have indicated that street development concentrates on increasing the carrying capacity but neglect the social and environmental costs (Appleyard *et al*, 1972). In the urban world, streets and roads play a major role since their setup constrains flow and accessibility to offenders in their routine activities whilst inducing an opportune environment for offending.

Urban planning clusters offence targets in specific areas, through increasing or reducing accessibility for opportunities. As against opportunities in rural areas where a person is more conspicuous, urban areas become attractive to offenders especially where an area becomes prosperous (Entorf *et al*, 2000).

Zoning practice and urban design has been found to alter crime patterns due to the presence of high volume land, accessibility, design, private and public spaces, and a host of other causes (Beavon *et al*, 1994; Pain, 1994).

#### 2.4.2 Social component

Socio-economic studies and its major component, deprivation, play an important part in understanding social structures and their relationship to studies in crime. Deprivation has evolved from the study of poverty to a wider 'contextually dependent' concept with the inclusion of issues as accessibility, isolation and peripherality (McCorquodale, 2001). The use of spatial analysis in GIS to measure poverty takes on a significant role as it brings the traditional 'poverty' studies in relation to offence location by showing the mechanisms each operates in: what is the background of an offender and where does he/she prey?

Deprivation comes in two forms: absolute or relative. Absolute deprivation refers to the unavailability of resources to meet the basic needs for healthy living and is the result of various factors particularly unemployment, lack of housing and schooling as identified by the UN Human Development Index, which indicate a 'weakening social fabric' and in turn a

deteriorating social cohesion. There is little evidence to suggest that absolute deprivation is an automatic precursor for crime as against relative deprivation that may in 'certain conditions lead to crime' (Young, 1997: 488; Lea *et al* IN Muncie *et al*, 2000).

Relative deprivation is the result of poverty where some citizens have significantly less access to income and wealth than others in their society. Crime is most prevalent in societies with these disparities, even in areas where absolute poverty is non-existent (Kawachi *et al*, 1999). Such societies move away from integrative social norms and in turn resort to an *anomie* situation (Merton, 1968).

Left realist criminology<sup>20</sup> asserts that the realisation that social 'goods' are within physical reach but grossly out-of-reach from acquisition by relatively-poor persons may in effect cause crime. Relative poverty and deprivation from 'goods' may lead these persons to attempt to make up for this perceived lack by 'acquiring' the 'goods' illegally.

#### 2.4.3 Relationship of social issues and landuse to crime

Kawachi *et al* (1999), use crime as an indicator of collective social well-being both in the social and health aspects, by analysing the degree of relative deprivation and the degree of cohesion in a society. The former looks at income inequality and the latter looks at the social relationship/social capital in that society. They state that crime is a mirror of the quality of the social environment and use state-level ecologic data to analyse deprivation.

#### **Variables for analysis**

Diverse variables are used to analyse crime and deprivation. The main one, unemployment, indicates a direct causality to crime particularly when the economy falls into recession and crime rates increase (Eitzen *et al*, 1988: 431). US federal prison population in the US tends to increase fifteen months after periods of high unemployment (Keebler, 1975). In another study, Craglia *et al* (2000) based their Sheffield studies on the analysis of households and unemployment, through the use of Townsend Index (Townsend *et al*, 1988), pointing out that crime statistics need to be based on young-male unemployment, population turnover and the DETR index of local conditions. Wang (1999) found associations between unemployment and crime with the link being stronger with structural unemployment.

---

<sup>20</sup> "Left Realism emerged in the early 1980s in Britain as a response to both the punitive and exclusion policies of conservatism and to the utopianism of New Left radical criminologies" (McLaughlin *et al*, 2001, 163)

Other researchers base their analysis on economic factors. Entorf *et al* (2000) use GDP and relative distance to average income. They include the % of population on welfare, the % of population below the poverty line and the Gini Coefficient as reliable variables for within-state studies of crime. One interesting point that they bring up is that offenders rate themselves in relation to national income rather than that of their own areas.

Other variables also employed include population density (especially in small island states), education advancement, high school dropout rate (Shaw-Taylor, 1998, 317) and per capita GNP (Wang, 1999). These factors highlight the importance of social cohesion since a high population density can induce a reduction of social capital due to the indifference attributed to knowledge of who one's neighbours are, and very little incentive to develop viable relationships. Interestingly, whilst school dropout is identified by Shaw-Taylor (1998), Rutter *et al* (1979) identified that at the other extreme school intake is just one factor that causes delinquency (where the best students are chosen by the best schools and low-achieving non-academically inclined students are then grouped together in low-achieving and inadequate schools). They found that delinquency is not directly linked to school activities but to offending outside school. Though this area requires further research, it is assumed that high school dropout rates may lead to more time to engage in activities where there is no adult supervision and could lead to offending.

Kawachi (1999) includes single parent households as a factor in crime analysis stressing that this family structure reduces control and supervision of potential offenders, again resulting in reduced cohesion and lack of role models. They also include educational attainment and average alcohol consumption levels in their analysis. They found that as the socio-economic status increased, homicide and assault rate declined but larceny increased. In addition, where poverty and unemployment increased homicides increased. One interesting factor was that median income was positively associated to robbery rates and motor vehicle theft. Alcohol was not found to correlate to violent and property crime.

Urban planning also plays a part in the dynamics of the interactions of offenders and offences, affluence and deprivation. Once an area has been zoned either as recreational or has 'tipped' following the deterioration of its demographic stock, urban issues have an impact on crime structures and vice-versa. As an example, out-migration can be linked to changes in the economic scenario such as the loss of jobs from a de-industrialised city. Taub *et al* (1984: 347) identified three issues for area deterioration analysis: i) crime levels are an issue in judging the quality of an area, ii) there is evidence of a 'threshold model' where people move out of an area

until tipping occurs, which few can stop, and iii) neighbourhood change is based on ecological facts<sup>21</sup>, individual and corporate decisions.

In summary, these factors bring into focus the need to identify the causal factors that result in the creation of a realistic evaluation of the crime, social and urban relationships. How does each variable lead to the commission of a crime? Which activities attract the highest crime rates? This issue is best tackled through the identification of the context within which an urban activity has been implemented.

#### 2.4.4 The need for further research

This study looks at such issues through a quantitative analysis of crime in the Maltese Islands based on spatial methodologies. Geographical Information (GI) would help identify the links through an analysis of crime, the social construct it operates in and the landuse aspect pertaining to the offender and offence locations. The GI factor helps identify such links however further study is needed in order to identify the multi-faceted relationships inherent in the social, urban and crime scenarios.

In effect, researching social and land-use issues in isolation may lead to unattainable understanding of what makes an area host offenders and/or attract offences. This study aims to identify whether there is a relationship between crime and land-use and social issues in the Maltese Islands. This will be carried out through an analysis of the spatial relationship between crime and social aspects as poverty through studies on welfare and Census data. In the case of the relationship between crime and landuse, spatial layers on zoning and structural planning will be analysed.

## 2.5 Summary of Chapter

The chapter described the development of the theory of environmental criminology and how it fits within other related theories such as Structuration, Opportunity and Routine Activity theories. It described crime in relation to the offender and offence location and identified how

---

<sup>21</sup> Ecological facts include an employment base for neighbourhood residents, housing market and demographic pressures, age and quality of the housing stock and external amenities such as vistas.

these different aspects of the theory fit together to form a comprehensive background for the analysis of crime.

Whilst the study aims to analyse crime in its spatio-temporal aspect based on an analysis of location of where offenders live and where they commit crime, the theories mentioned above point at the need to move one step beyond the geographical aspect and analyse criminal activity in relation to the structures of the areas the offenders live in, interact and commit crime.

This study aims to review spatial distribution of crime in Malta through offence statistics, the analysis of criminogenic areas through offender-offence analysis and the relationship of crime to social and landuse issues.

The main research questions to this study are discussed in the next chapter.

## **Chapter 3: Research Questions**

### **3.1 Introduction**

This Chapter lays out the aim and objectives of the study. A brief description of each objective is given together with a short depiction of how it will be achieved. This is followed through by the development of a Conceptual Model that attempts to mindmap the processes that have been identified in the literature together with the relative social and landuse interactions. The conceptual model seeks to cover the principal areas of crime beginning with an initial understanding in the abstract of the correspondence between criminological, social and landuse factors. The model is then further developed through two more increasingly-detailed levels that progressively attempt to draw a mindmap of links that help understand the relationships between each component of the three disciplines. The third and final level identifies datasets that are available in the Maltese Islands and those that need to be included in future research in order to carry the model to fruition. In effect, the model serves to form a platform for this current study and also to form a basis for further study beyond this research. The chapter finally lists the research questions that will be investigated in the study based on the crime, social and landuse structures.

Attempting such a construct that employs the three pivots of the CRISOLA model, necessitates that some of the steps required to understand by crime occurs where and when it does, would involve a study of relationships that are non crime specific. This is important to ensure that the basis for understanding the relationship between two variables is established prior to any cross-thematic comparison. A specific case in point would be the analysis of offender residence and incidence of poverty, which necessitates a series of background or first-level analysis to understand whether poverty in effect exists within specific areas where offender-specific hotspots have been identified. The research questions listed in Section 3.4.2 and as researched in chapter 8 specifically employ such a method. As an example one has to establish whether there are poverty hotspots in Malta and subsequently looks for correlation of crime-poverty relationships in those hotspots through cross-thematic analysis. The results would then point towards an understanding of the geographical patterns of crime within a social and landuse construct.

### **3.2 Aims and Objectives**

The aim and objectives outline the main thrust of this study, that of understanding crime in a small island state. They do not aim to create a solution to the crime issues pertaining to such

countries, but aim to initiate the process to reach this goal. At the start of this project, little or no data existed in digital format in the Maltese Islands, a situation that entailed starting from scratch leading to sourcing, identifying and inputting the data, through to the process to 'spatialise' it in a format compatible with GIS. Only then could analysis start, which meant that part of the objectives had to cover the bringing together of the datasets, their integration into one system and the subsequent analysis in line with criminological theory.

### 3.2.1 Aim

The research aim is:

*to develop an understanding of the spatial and temporal patterns in criminal offences, victimization and offending in a small island state and to analyse the relationship between these patterns and the socio-economic and land use composition of the Maltese Islands..*

A number of objectives serve this aim. These are presented below in the form of a series of stated objectives (in bold) accompanied by brief text descriptions setting out how each of these will be met.

### 3.2.2 Objectives

The first objective strives to understand environmental criminology theory, the next three tackle data processes and GIS issues. The fifth objective looks at the need to develop a conceptual model that brings together crime, social structure and landuse and builds a detailed model that would lay the groundwork for this and further study. Objectives six through eight are concerned with the analysis of data on crime, convicted offenders and the social and land use environments.

**Objective 1. To explore how far technological innovations and research tools such as geographical information systems can be combined with theories from environmental criminology to better understand patterns of crime in the Maltese Islands**

*This objective aims to cover environmental criminology theory, especially its empirical use for understanding different perspectives to crime research and policymaking and how these can be subsequently analysed in the Maltese context through the use of high-end technology. Tackled in Chapters 1, 2, 4 and 5.*

**Objective 2. To review the availability of relevant data on crime, social issues and land use in the Maltese Islands**

*This objective aims to carry out an exercise that identifies which data exists in the Maltese islands and where possible to convert from analogue to digital format for analysis in the later sections of the study. Tackled in Chapter 6.*

**Objective 3. To geocode and geo-reference data on crime, social conditions and land use to enable the first Maltese crime, social and landuse maps to be created**

*This objective aims to carry out an exercise that processes the data available into GI format through geocoding and georeferencing to present a series of spatial data layers on crime, social aspects and land use. Tackled in Chapter 6.*

**Objective 4. To develop a Web-based crime mapping system for Malta**

*This objective aims to carry out an analysis of the available international Web-based crime-maps and to investigate the creation of a Maltese Web-based interactive mapping system. Tackled in Chapter 4.*

**Objective 5. To contribute to the development of a conceptual model of crime in the Maltese Islands and its links to social and landuse issues.**

*This objective will provide a mindmap model that depicts the relationships between the three aspects of crime, social and landuse issue. It also attempts to draw up a linkage-map for the analysis of the different datasets and the measures needed to achieve a better understanding of the relationships. This model calls for further development post-this study. Tackled in Chapter 3.*

**Objective 6. To analyse the evolution of crime trends over space and time and to compare crime in Malta with that in other countries.**

*This objective aims to carry out an initial study of crime in Malta as compared to other countries in the EU and also small island states. It also aims to carry out statistical analysis of local generic crime and provide an understanding of trends in relation to changes in crimes over time. Tackled in Chapter 7.*



**Objective 7. To carry out a case study of convicted offenders between 1950-1999 and convicted offences between 1990-1999 resulting in a detailed spatio-temporal analysis of crime.**

*This objective will provide detailed data on 1950-1999 offender trends at small area levels with analysis carried out primarily for changes in offender and offence situations over time. It will also analyse offence locations between 1990-1999 in relation to socio-economic (poverty) data from the 1995 Census of Population and Housing as well as more recent welfare data. Tackled in Chapter 8.*

**Objective 8. To carry out an analysis of geocoded offences as related to landuse and social aspects based on reported crimes from 1998-2003.**

*This objective will provide detailed data on offence trends at small area levels with analysis carried out in relation to spatial data from the landuse maps. The study will analyse changes in crime through space and an analysis of crime in relation to the socio-economic (ex. Recreation)) and landuse zoning situation of the islands. Tackled in Chapter 9.*

### **3.3 The Conceptual Model**

Why create a conceptual model? Such a question lingered through the reviews of the environmental criminology literature, the GIS literature and the Maltese scenario readings. The reviews, together with an understanding of the complex Maltese data availability situation, highlighted the need to bring together each aspect and build a mindmap that helps set out a process to depict a basic and generic model on how crime, social and landuse issues interact together.

The review process also identified techniques and datasets that can be used in the identification and understanding of crime. The use of these datasets is best explained through a conceptual model that is relevant to **CRIME** and to the **SOcial** and **LANduse** aspects, herein embedded as the acronym **CRISOLA**.

The model took shape through a tiered 3-phase process, with each iterative phase building up from an abstract level (Phase 1) through the identification of the main datasets (Phase 2) to a final individual attribute listing (Phase 3). The model is not exhaustive as it covers potential datasets that yet need to be created/surveyed, statistical measures identified as well as inclusion of other crime-relevant theories. The model can be evolved in future studies as it attempts to

highlight areas of study that will not be tackled in this research and which may/may not be found to be significant, entailing further change.

### 3.3.1 The three CRISOLA radials: Crime, Social and Landuse

Initially the conceptual Model catered for the crime aspect in isolation, but crime does not stand alone: it interacts within a wider and more complex environment. The mindmap exercise soon sought the inclusion of social and landuse parameters within the model aimed at streamlining the process to facilitate the analysis. The result brings together the three CRISOLA disciplines and attempts to identify theoretical links between the different datasets.

The decision to model crime together with the sociological and landuse disciplines is based on an understanding of the interactivity between the three as identified in the literature. The model attempts to understand criminal activity within the social and physical structures it operates in. The main area of study is the interaction between:

- i) the crime characteristics through an analysis of offender and offence composition and the interactivity between them,
- ii) the social characteristics of an area through an analysis of its poverty/deprivation,
- iii) the physical characteristics of an area, particularly its landuse, structural and zoning parameters.

The social characteristics of a human society are linked to the physical surroundings it operates in, which two characteristics are directly caused by or affect crime. Offender analysis requires an understanding of the social construct that the offender operates in, such as affluence and poverty. Offence analysis requires an understanding of the landuse structure crime occurs in; the opportunities offered, the mode of travel, and the activities that may lead to the occurrence of crime, amongst others.

### 3.3.2 Phase 1 – The Abstract Level

Table 3.1 outlines the Phase 1 thought-process needed to reach an initial structure within which to analyse any relationships between the three disciplines. It is a high-level abstract model that attempts to look at parallel processes between the three disciplines and how an understanding of the processes can be achieved. It develops the concept through a series of five linear steps that can be tackled in order to facilitate later cross-thematic crime studies. It is aimed at an analysis of

the thematic structure, focusing on the main parameter in the themes that affect change, identifying the spatial construct within the theme, highlighting the impact on capital and cohesion and finally leading to a change phase.

The latter phase can only be tackled through longitudinal studies that would draw a better long-term picture of what constitutes change. Although the current study looks at crime over a period of time, this model needs to be revisited with longer-term data if one needs to analyse sturdier change processes. This is needed particularly in the final phase that covers change for each of the CRISOLA themes.

Table 3.1: Phase 1 - Conceptual Model Logical Matrix

Social	Crime	Urban
Analysis of the Social structure of the area under study	Analysis of crime in the area under study through offences and the behaviour of offenders	Analysis of spatial constructs through a study of landuse zoning, spatial aggregates and physical structures
↓	↓	↓
Focuses on socio-economic and socio-cultural parameters towards an understanding of poverty and deprivation as a surrogate for social and community health	Focuses on offences as a measure of attractiveness of an area and focuses on offender data as a measure of social disorganization	Focuses on landuse zoning as a measure of affluence, leading to an understanding of opportunity structures
↓	↓	↓
Identifies the social-spatial constitution of the areas, leading to a social-zoning structure	Identifies the criminal-spatial constitution of the areas leading to a crime-zoning structure	Identifies the physical constitution of the areas leading to a landuse-zoning structure
↓	↓	↓
Impact on social capital – social cohesion	Impact on security and safety	Impact on spatial capital
↓	↓	↓
Social change	Crime change	Landuse change

### 3.3.2 Phase 2 – Identifying the linkages

Whilst, the high-level Phase 1 Model enables a generic focus on the study in question, a more detailed second level model was required which helped point at and identify the interactivity between the three parameters. This is accomplished preferably through the identification of

datasets that may be used for analysis. Being a mindmap model, Phase 2 (Figure 3.1<sup>22</sup>) sought to identify those literature-related issues and integrate them within the model. It also sought to bring together the different Theories, Datasets, Spatio-Temporal Aspects, predictors and the main tenets that can be used in such a study on crime. These include such parameters as age and density, which have been described in the literature review chapter.

The deeper one moves into the model (towards the bottom part of each section and where the predictors are highlighted) the more research is needed to identify the real relationships and how each parameter can be predicted. The model does not attempt to solve these issues in this study but depicts the potential future studies that can be attempted.

The following walkthrough of the Model in Figure 3.1 shows the three distinct social, crime and landuse sections. Each section has a series of data-boxes each depicting a specific theme, index or concept. The following section describes one such databox.

#### ***A Social section walkthrough: Taking the proximity databox as an example***

*Refer to the Phase 2 data model and identify the proximity index databox within the Social section.*

*The proximity index attempts to elicit an understanding of each area in Malta through its location in relation to proximity to a number of factors. These are split in two:*

- i) the proximity to the community centre (identified by the number 3, which number also refers to the relative Phase 3 data-box) and*
- ii) structures identifiers split into four themes,*
  - a. two related to building state such as vacancy (4) and dilapidation (5) (indicates broken windows-tipping) and*
  - b. the other two related to densities – population (6) and dwelling (7).*

*The latter four would together be developed into a structural poverty index (8) that would be integrated with the proximity to the community centre theme. These two constructs would enable the creation of a spatial poverty index (9) that introduces a concept which identifies that poverty is not essentially an economic construct but is also related to access to the community construct. Taking the model further, integrating the socio-economic poverty index (10) created through a separate integration process, with the spatial poverty index (9) would result in a deprivation index (11). This process is followed by a statistical measure that would eventually result in the identification of a categorisation of different social zones (12).*

---

<sup>22</sup> The PDF version of this document allows zooming into the model.

*It is at this stage that the first cross discipline links are highlighted: those of the identification of a possible link between social zones (12) as identified through the process described above and the potential relationship (brown link) to the offender location (37) that looks at the social zoning pertaining to convicted offenders. This link can be further analysed through statistical measures. Other potential cross-discipline relations are identified through the link between the social (poverty) zones (12) and the landuse social and community-related zones (15). This link could better describe the relationship between the 'poor' areas and their location in the landuse designated for social use as against industrial and recreational use. It may identify 'poor' areas that are situated outside of the social zones as well as concentrations within specific areas of the social zones. Other lower-level links between the different themes would relate to the linkages between the final level of each theme and the potential impact on each resulting in a change in the other. The social zoning (12) to landuse (27) link is such a potential link (red line) where one could predict changes in deprivation through changes in the landuse construct and vice versa.*

The other sections follow the same logical process and each successive branch highlights its particular theme, theory base and dataset pertaining to it. The best way to follow this is within the model is to once again look at the proximity index example in Figure 3.1. The level 2 model in Figure 3.1 is accompanied by a description and spatial levels key (Figure 3.2). The key describes the different spatial data aggregates available from national to regional to enumeration areas, which data layers can be employed for most datasets listed. The description section, however lists the different datasets available (D), the theories (T), the main data tenets (M) as well as other relevant information.

Once again, taking the proximity index as an example, the proximity-to-centre data-box (3) is tagged with 3 codes, amongst them D2A. The D2A refers to the key: Data (D) is available at (2A) Address-point spatial detail. Similarly the vacancy (4) data-box is tagged with T3A and D2I, where as an example T3A refers to social disorganisation theory and potential to analyse the data based on concentric rings and broken windows concepts.

Other model issues include the identification of a potential to integrate a dark figure of crime, once this is carried out. To date this has not been covered in Maltese crime studies, except for a study carried out by the author where the sample return was too small to prove reliable.

The coloured data-boxes indicate some kind of major studies that were not found in the literature review but are deemed essential to understanding crime, such as the analysis of spatial-temporal-prediction-fragmentation (31) which attempts to understand the spatial aggregate (ex: council, enumeration area, street) at which predictability starts to deteriorate over time and which would

allow researchers to know how far to predict at each level in order to remain statistically significant. Such a model would help crime understanding for operational and tactical levels.

### 3.3.3 Phase 3 – Identifying the datasets and attributes

Taking the model one step further to Level 3 (Figure 3.3)<sup>23</sup>, a series of statistical measures are listed for the variables within each dataset identified for model integration. This level is theoretical as each link needs to have a theoretical construct attached to it with the relevant research studies carried out which would validate that such a model can work.

The Phase 3 is highly detailed where it looks at each data-box, identifies the relative dataset as indicated in Phase 2, lists the attributes within that dataset and then attempts to identify statistical measures for each level within the process. In most cases, the statistical measures call for further research into the potential measures to be employed. Also, at this stage new indexes were inputted such as insurance, sentencing practice and recidivism, each of which was identified as vital to a particular complex index.

As in the Phase 2 case, the best way to understand Phase 3 would be through an example, that pertaining to the proximity-to-community-centre data-box (3). In Phase 3, a statistical measure is listed as distance-to-centre which is further explained through the use of a distance ranking index based on GI buffering techniques employing 100m intervals.

New indexes are also identified in Phase 3, which indexes help to clarify how a more complex index is created. The following example is based on the welfare index (2) that is split into two component indexes (persons-at-risk and structural-dependency). Each of these is composed of three data complexes (ex: pensions, social assistance, widows survivors), where each complex is composed of the sum ( $\Sigma$ ) of a number of welfare benefits pertaining to that category (attributes within the welfare index dataset). For example, widows survivors is composed of Widows pensions (NM and NMWP), Survivors pension (SRP and ESRP). The results are then integrated with other categories as in the Phase 2 process described earlier.

### 3.3.4 Conceptual Model Summary

In summary, the main aim of producing these three Phases was primarily targeted at understanding the potential relationships between the CRISOLA constructs. These relationships

---

<sup>23</sup> The Level 3 model is better viewed in PDF format as it is too large to manage clearly within this document.

operate within a human environment that is intrinsically dynamic, where any change in one sector would affect the other two, positively or negatively. The model will be used post-research to further refine the theories and carry out in-depth studies in each of the sectors and linkages.

The conceptual model was drafted to enable the author to focus the direction this study would take through the identification of some of these areas that can be analysed, whether data exist to support such studies and also to identify further areas of research. It also helped to list the relevant theories, the data availability, the spatial and temporal aspects and the potential relations between the different CRISOLA constructs.

Once the conceptual model was drafted, the next stage of the study concentrated on the drafting of the research questions.

Figure 3.1: Conceptual Model Phase 2 – Linkages – Themes - Key

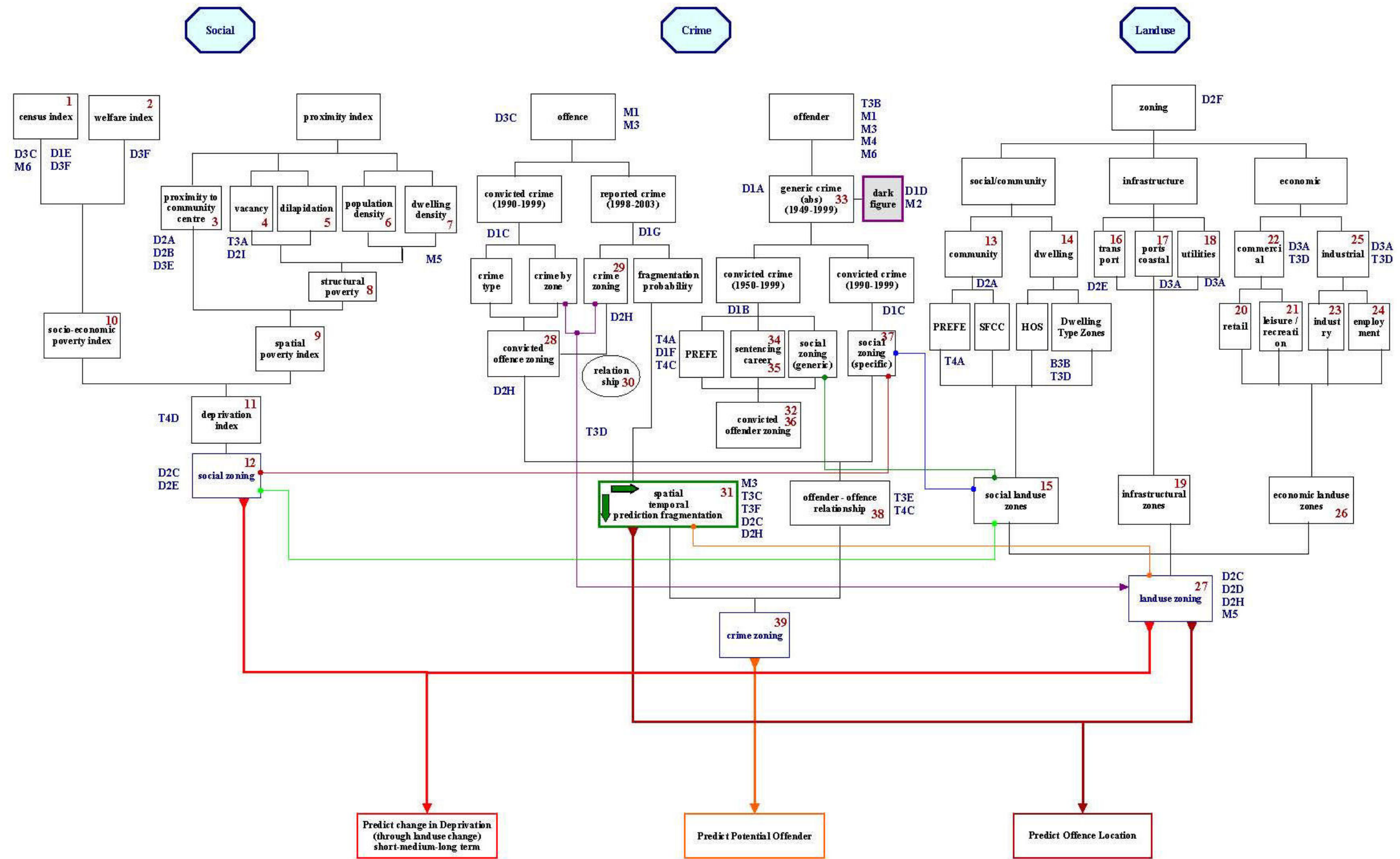




Figure 3.2: Conceptual Model Phase 2 – Linkages – Themes - Key

Data (D)

- 1) Crime Data
  - a) 1949 - 1999 (Abstract of Statistics - Historic)
  - b) 1950 - 1999 (CCF Offender)
  - c) 1990 - 1999 (CCF Offence)
  - d) 2000 - 2005 (dark figure)
  - e) 2001 (education absences police)
  - f) 1993 - 2004 (Enforcement development cases)
  - g) 1998 - 2003 (police reported crime)
- 2) Landuse Data
  - a) Address point
  - b) Basemap extractions
  - c) Boundaries
    - streets
    - enumeration areas (EAs)
    - councils
    - regional
      - local plan areas (LPAs)
      - police
      - health
      - census
      - NUTS (S-1)
      - conurbation
  - d) Planning applications
  - e) Transport
    - roads
    - streets - Link Tables
    - bus routes
  - f) Urban - rural
    - development zones
    - zoning
  - g) Urban Conservation Areas (UCAs) / village cores
  - h) Development PLAN (base map extraction)
  - i) Maltamal (utilities - vacancies - migration)
- 3) Social Data
  - a) Economic
    - town centers
    - recreation
    - retail
    - industry
    - employment
  - b) Housing zoning - HOS
  - c) NSO - socioeconomic Census 1995
  - d) Welfare - 1995 - 2003
  - e) Education
  - f) Health

Theories (T)

- 1) Rule relativist - social construct
  - space
  - time
- 2) Radical conflict - human rights
  - law
  - (power)
- 3) Environmental criminology
  - a) Social disorganisation
    - concentric rings
    - broken windows
  - b) Offender
    - individual
    - family
    - community
    - country
      - careers
      - networking
  - c) Offence
    - zoning
      - urban / rural
      - housing market
      - commercial
    - victimisation
      - networking
    - defensible space
  - d) Opportunity
  - e) Routine activity
  - f) Predication fragmentation probability
    - space
    - time
    - thematic
- 4) Sociological
  - a) PREFE
    - Politics
    - Religion
    - Education
    - Family
    - Economy
  - b) Networking
  - c) Structuration (3b-3c)
  - d) Deprivation
    - Poverty - Absolute / Relative

Main Tenets (M)

- 1) Age
  - 2) Dark figure
  - 3) Seriousness
  - 4) Recidivism
  - 5) Density
  - 6) Unemployment
- Spatio-Temporal
- 1) Thematic (H)
  - 2) Spatial (S)
  - 3) Temporal (P)
- All datasets in model are:
- 1) Spatial
  - 2) Thematic across
    - social
    - landuse
    - crime zones
  - 3) Temporal
    - a) 1950 - 1999 (base data - offender / crim)
    - b) 1990 - 1999 (specific period - offence)
    - c) 1995 - 2003 (reported crime - geopo) (census) (social data)
    - d) Landuse data
      - current
      - 1990 - 2004
- Predictors
- 1) Potential offender - TURF
  - 2) Potential Offence - SHIFT
  - 3) Potential Deprivation - SHIFT

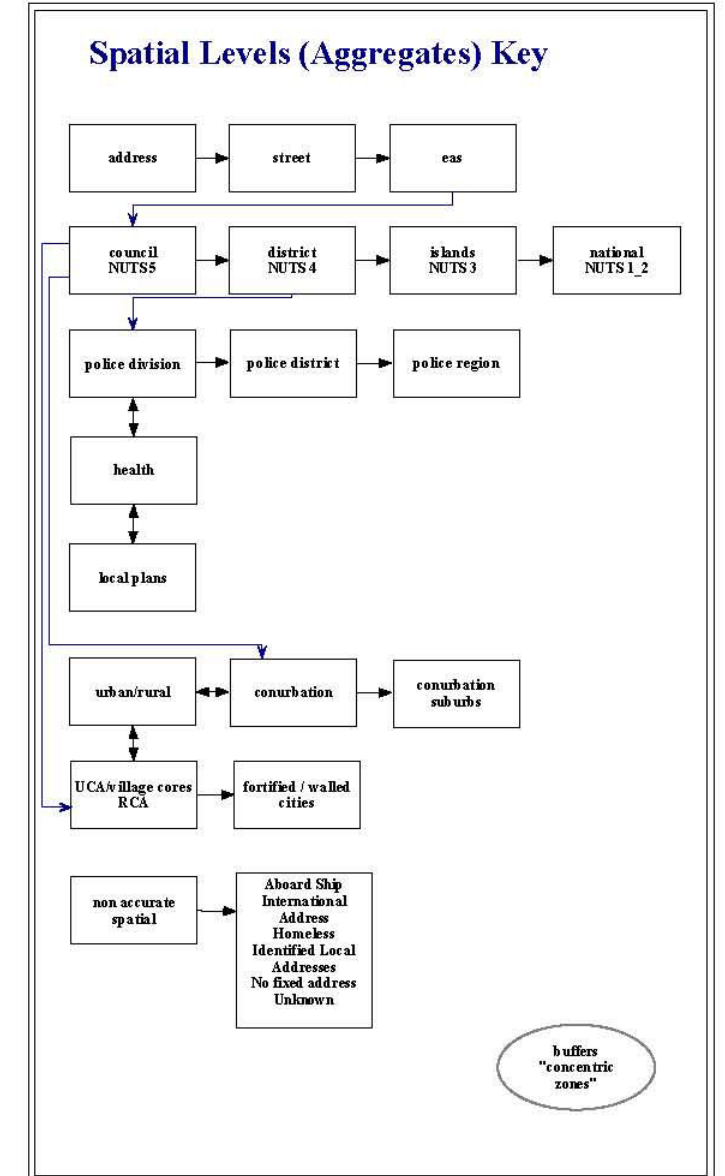
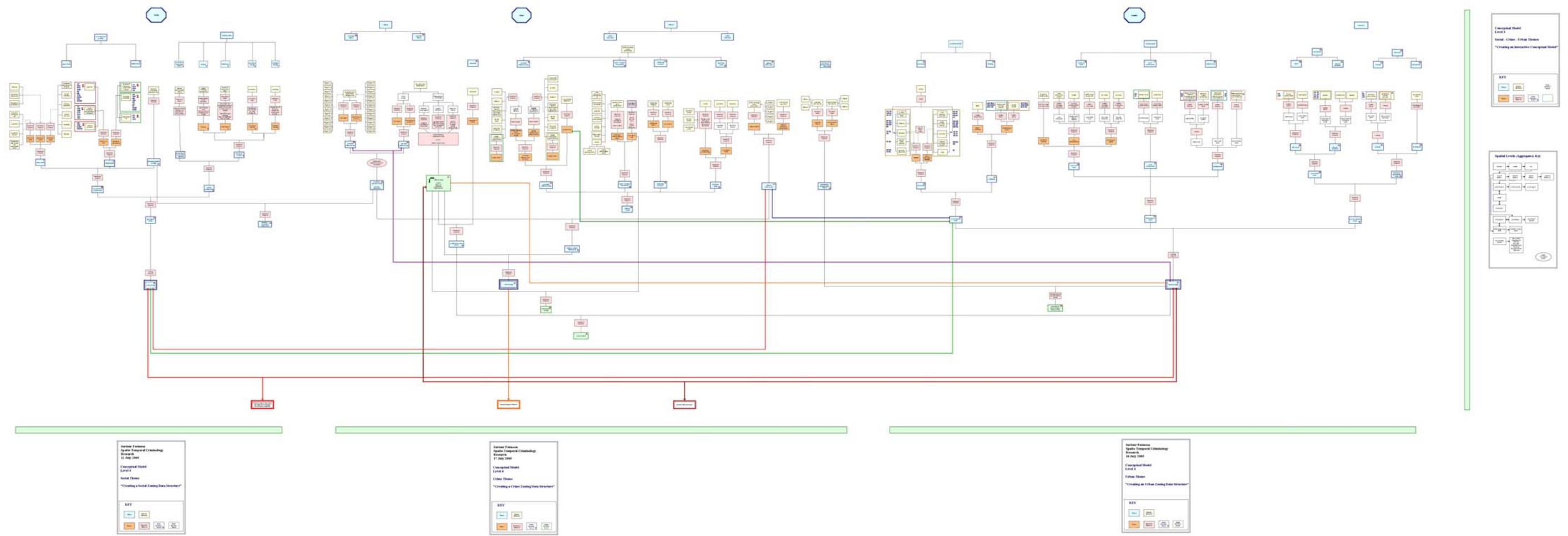
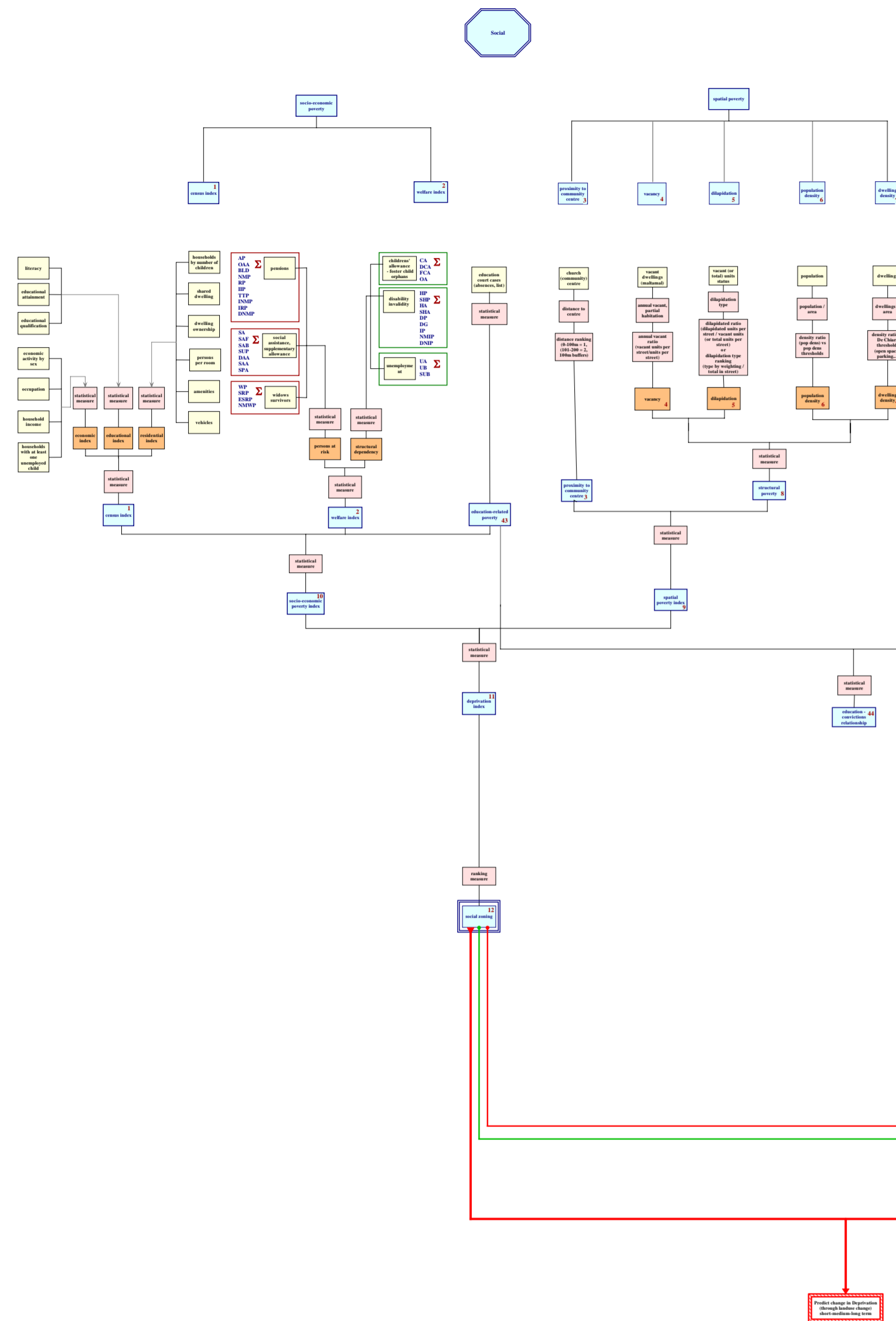
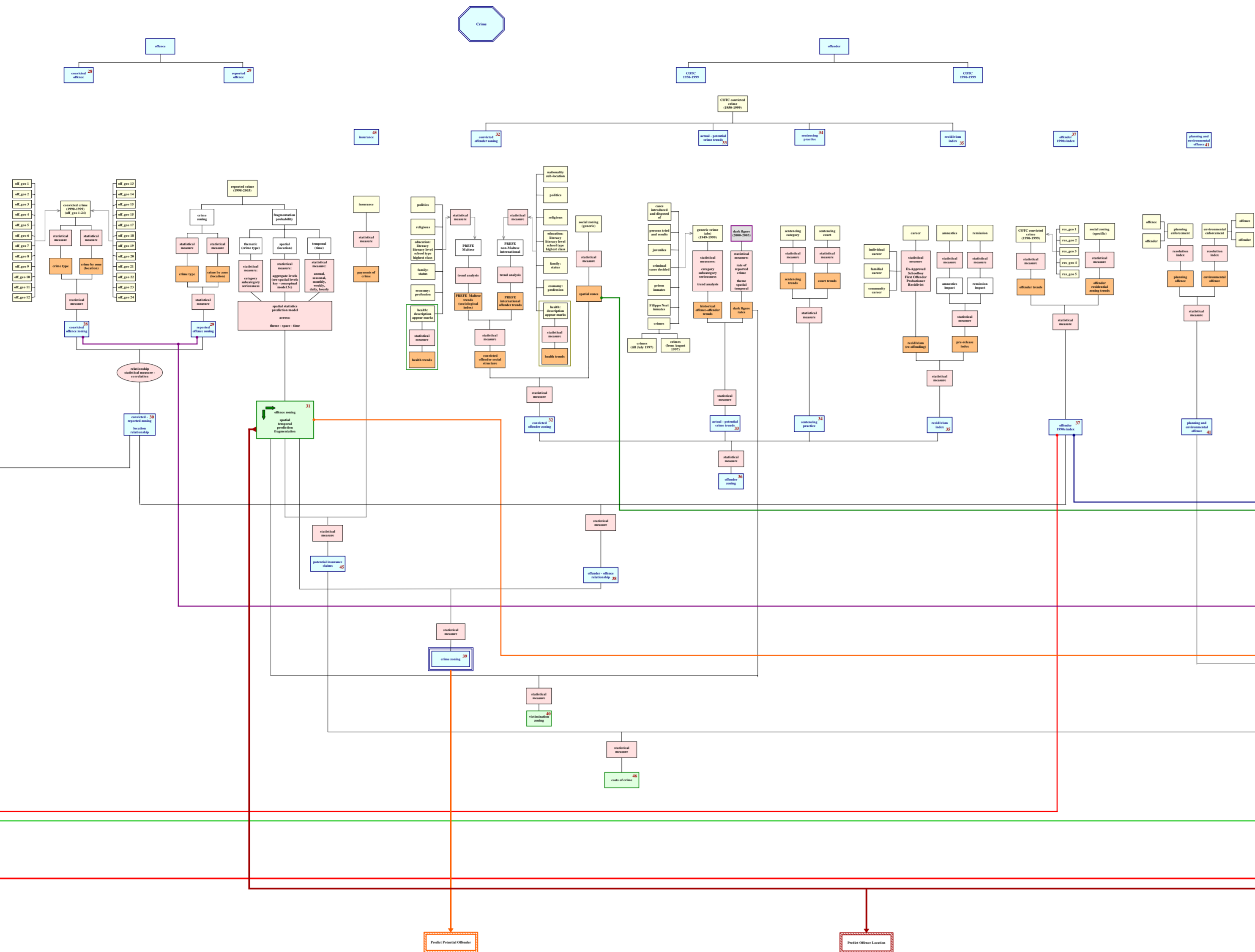


Figure 3.3: Conceptual Model Phase 3 – Datasets, variables and Statistical measures model cont...

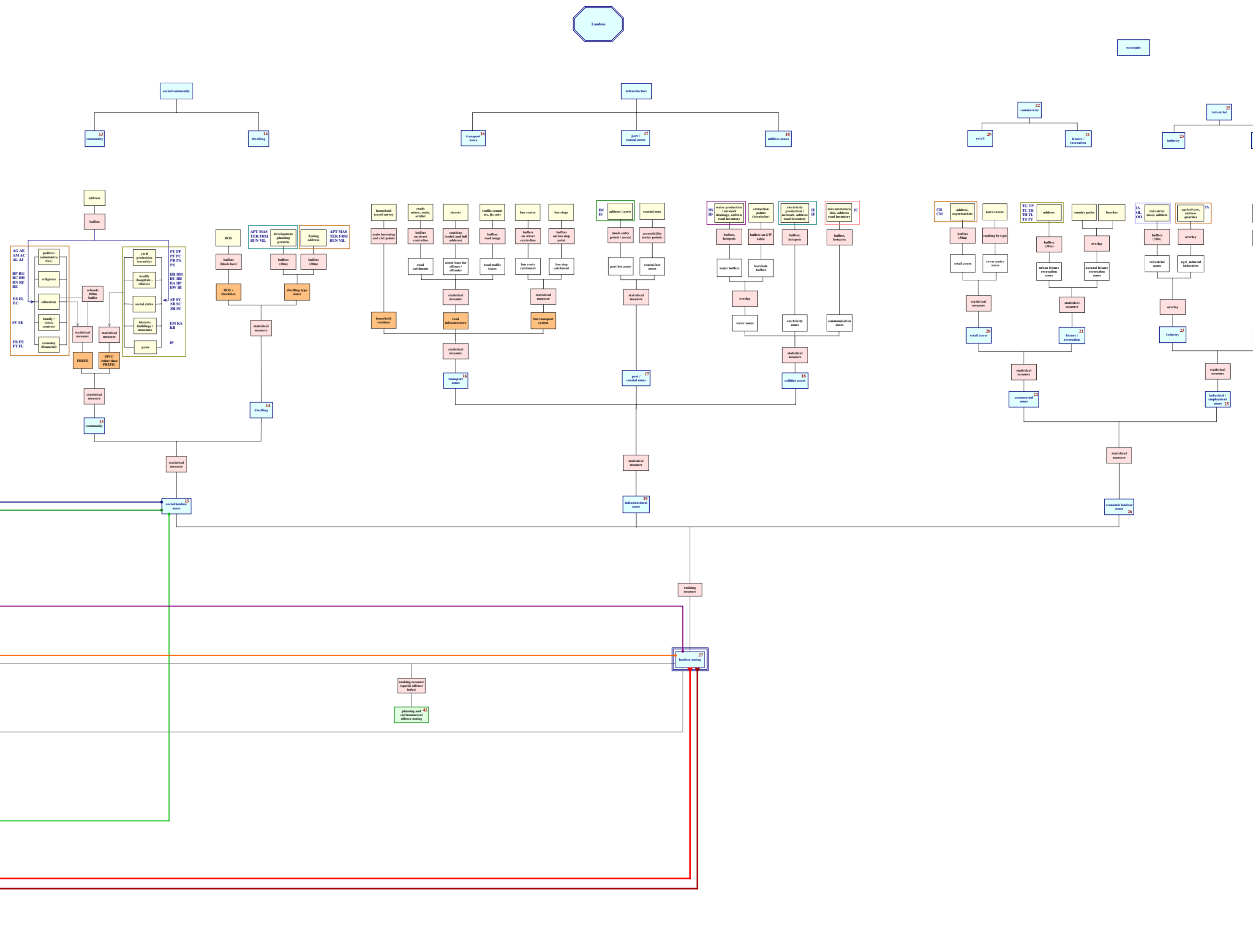




Savouir Formosa  
Spatio-Temporal Criminology  
Research  
12 July 2005  
Conceptual Model  
Level 3  
Social Theme  
"Creating a Social Zoning Data Structure"



Savouir Formosa  
Spatio-Temporal Criminology  
Research  
17 July 2005  
Conceptual Model  
Level 3  
Crime Theme  
"Creating a Crime Zoning Data Structure"



Savouir Formosa  
Spatio-Temporal Criminology  
Research  
16 July 2005  
Conceptual Model  
Level 3  
Urban Theme  
"Creating an Urban Zoning Data Structure"

**Conceptual Model Level 3**  
Social - Crime - Urban Themes  
"Creating an Interactive Conceptual Model"

**KEY**

- Social
- Urban
- Crime
- Other

**Spatial Levels (Aggregates) Key**

- Level 1
- Level 2
- Level 3
- Level 4
- Level 5
- Level 6
- Level 7
- Level 8
- Level 9
- Level 10
- Level 11
- Level 12
- Level 13
- Level 14
- Level 15
- Level 16
- Level 17
- Level 18
- Level 19
- Level 20
- Level 21
- Level 22
- Level 23
- Level 24
- Level 25
- Level 26
- Level 27
- Level 28
- Level 29
- Level 30
- Level 31
- Level 32
- Level 33
- Level 34
- Level 35
- Level 36
- Level 37
- Level 38
- Level 39
- Level 40
- Level 41
- Level 42
- Level 43
- Level 44
- Level 45
- Level 46
- Level 47
- Level 48
- Level 49
- Level 50
- Level 51
- Level 52
- Level 53
- Level 54
- Level 55
- Level 56
- Level 57
- Level 58
- Level 59
- Level 60
- Level 61
- Level 62
- Level 63
- Level 64
- Level 65
- Level 66
- Level 67
- Level 68
- Level 69
- Level 70
- Level 71
- Level 72
- Level 73
- Level 74
- Level 75
- Level 76
- Level 77
- Level 78
- Level 79
- Level 80
- Level 81
- Level 82
- Level 83
- Level 84
- Level 85
- Level 86
- Level 87
- Level 88
- Level 89
- Level 90
- Level 91
- Level 92
- Level 93
- Level 94
- Level 95
- Level 96
- Level 97
- Level 98
- Level 99
- Level 100

### 3.4 The Research Questions

The research questions that will be looked into in this study cover crime and its relationship to social and landuse issues. The questions are based on a review of the main questions elicited during the literature review and the main constructs pertaining to GIS and how they deal with the Maltese Islands situation. The use of the conceptual model framework was made to help identify which hypotheses cannot be answered through such a framework.

The research questions look at each of the CRISOLA constructs in sequence and help build a structure within which to help understand the crime scenario for Malta. This ranges from the reviewing of Malta's position in an international crime league-table to micro-environment spatial analysis of crime-social and crime-landuse relationships. There is some level of overlap between the three sections, though this is inevitable due to the close relationship between the three disciplines. In fact, the research questions fall within different chapters (7, 8 and 9) and are individually tackled in each, though not necessarily following the sequence listed below. Where appropriate, each section has a sub-section (boxed) that lists those questions which cannot be answered in this research but are relevant to the CRISOLA structure and which would serve for future studies.

The first section lists the research questions / hypotheses pertaining to the crime aspect.

#### 3.4.1 Crime

This section covers the generic crime data issues aimed at understanding Malta's crime structure at international and local levels. It also looks at the offender and offence themes and how these change over space and time.

##### **The international aspect**

This set of questions attempt to elicit answers about Malta's position in an international context, based on a comparative analysis with selected European countries and secondly with similarly small island states.

1. What is Malta's relative crime position as compared to i) European countries and ii) other small island states around the world?

2. Does Malta have a higher-than average crime rate in Europe?
3. Does Malta have a higher-than average crime rate in comparison to other Islands?

### **The national aspect: geographical and temporal**

This set of questions look at generic issues related to the spatial position of the Maltese Islands and the issues that are not strictly related to the social and landuse aspects but may have an effect of the commission of crime. These include the issues of climate, seasons and time that crimes occur in.

4. Is there a seasonal effect to crime?
5. What is the temporal effect on crime – at what time does crime occur most and which categories are most affected?

#### **Research Questions for future studies**

- A. Does climate play a role in crime in the Maltese islands?
- B. Is there a season-time relationship – do crimes occur at higher rates during summer weekend nights as against their winter counterparts?

### **The national aspect: offences**

This set of questions attempts to understand how crimes have changed over time, based on rates and seriousness of the crimes commissioned. It looks at the relationship between offences and the locations they occur in and strives to understand which areas are prone to most offences.

6. Have crime rates increased over time?
7. Are serious crime rates very low in Malta?
8. Are there distinctive regional level variations in crime?

#### **Research Questions for future studies**

- A. Does crime change over time (type of crime) as a consequence of affluence? (Crime increase that reflects higher affluence, more vehicles around and more property to steal in domestic burglaries)
- B. Is there tourist-related crime in Malta?
- C. Where and when does tourism-related crime occur?
- D. How far does crime reflect to tourism-related seasonal changes in population levels?

- E. What is the relationship between specific summer-peaking offences and the targets/victims?
- F. Is there a relationship between offences such as threats and bodily harm and climatological issues as high temperatures, humidity and high pressure systems, particularly in the summer months?

### **The national aspect: offenders**

This set of questions tries to draw up a picture of Maltese offenders, understand their background, the type of crime they commit. It then looks at where they reside in order to elicit common characteristics pertaining to their situation.

9. Do offenders have a common social background?
10. Do offenders have similar employment (unemployment) characteristics?
11. Are offences committed by known offenders becoming more serious over time?
12. To what extent do offenders live in concentrated areas such as the old cities, village cores, Housing Estates, etc?
13. Is there a North-South-Gozo divide in offender residence or does it occur at regional level?
14. Do some locations have a high offender density than one would expect on the basis of their population density?
15. How common is recidivism and to what extent is it restricted to a limited number of individuals?

### **Research Questions for future studies**

- A. Why is an offender residence concentration increasing in the towns that are experiencing a decrease in population?
- B. Does statistical significance in population density and offender rates change at different spatial levels such as EAs, and the diverse NUTS levels?

### **The national aspect: offender-offence**

This set of questions looks at the offender-offence relationships and tries to elicit the spatial relationship between offender residence and offence location.

16. Do offenders commit crimes close to where they live?

17. If offenders commit crimes close to where they live, then does this vary by type of crime?

**Research Questions for future studies**

A. Is there a correlation between commuting patterns and the location of offender residence and offence location?

B. Do offenders partake in journey-to-crimes based on particular localities, type of offence, time and day?

C. Do amnesties and remission play a role in rehabilitation or does re-offending occur in the period under remission/amnesty?

### 3.4.2 Social

This section poses questions of social structure in terms of poverty and seeks to elicit any relationship between these locations and the offender-offence issues. It tackles population, housing stock and economic issues. This section serves to lay the foundation for the investigation of the social parameters when they are investigated against the crime-related parameters. In effect, this section leads to an understanding of the geography of crime in terms of those sociological relationships that may be the source or effect of crime activity both in relationship to offender and offence. Such parameters include the type of housing offenders live in, the housing tenure, the type of landuse designation such as the village cores which could be dilapidated and serve to attract offenders, whilst others include the socio-economic structure of an area which may serve to attract offenders and/or offences.

#### **The population issue**

This set of questions looks at the population structure at different spatial levels. It reviews the main demographic parameters of age, gender and density against offence incidence, unemployment and poverty.

1. Do younger age cohorts have higher crime rates?
2. Are crimes more prevalent in high-density residential areas (high population density) than sparsely populated areas?
3. Is unemployment and poverty higher in more densely populated areas?
4. Is crime in any one area disproportionately concentrated compared with that area's share of the total population?

5. Are offenders in any one area disproportionately concentrated compared with that area's share of the total population?

**Research Questions for future studies**

- A. How far do changes in the male population result in more/fewer crimes?

**The housing issue**

This set of questions takes the issue of residence to another level, looking at the actual structure of the residential construct. This is done through an analysis of the area designation (such as village cores), dwelling density structures, dwelling types and housing estate areas.

6. Are high rates of vacant dwellings related to high levels of crime?
7. Do different dwelling type zones exhibit different crime rates?
8. Is poverty related to dwelling type?
9. How far is crime concentrated around the village cores?
10. How does crime change with distance from the cores?
11. How far is poverty higher in high dwelling density areas?
12. Do Housing Estates have higher rates of poverty than elsewhere?

**The economic/poverty issue**

This set of questions attempts to understand the relationship between poverty and offender-offence locations. It looks at the incidence of clustering between similar spatial locations.

13. Do poor areas tend to be located nearer to the old (village cores) areas?
14. Is there a strong relationship between offence locations and areas of high unemployment?
15. Do most crimes occur within close-proximity to socially-sensitive locations such as schools?

3.4.3 Landuse

This section looks at landuse issues and attempts to understand the relationship between landuse and crime incidence. This is done through an analysis of the different spatial levels and their



relationship to offences. It looks at the buffering question and whether it can be applied to the Maltese context.

### **The Spatial construct**

This set of questions looks at the different spatial levels and how they relate to crime. It seeks to understand if there is a distinction between rural and urban crime and whether the older areas suffer from higher crime rates than the rest of the locations.

1. Do urban areas have higher crime rates than rural areas?
2. Are rural crimes highly specific?
3. Do coastal towns have higher rates of crime than elsewhere?
4. Do village cores have a higher rate of crime than newer areas?
5. Do the old cities have a higher rate of offences than elsewhere?

### **The Structural construct**

This set of questions attempts to elicit the relationship between crime and such structural components as development planning, housing and mobility. It also strives to elicit the realities of employing buffer techniques in the environmental criminology tradition to the Maltese context.

6. Is there is a relationship between landuse zoning and offence type

#### **Research Questions for future studies**

- A. Is there a relationship between transport and crime levels? – Do the main transport corridors have a high rate of crime relative to the adjacent areas?
- B. How far do spatial and temporal variations in crime reflect commuting patterns?
- C. Do bus transport corridors have high rates of specific crime types? – How far can one see change in transport corridors (bus stops and bus routes corridors)?
- D. Is there an impact on crime of development permits? – Do development permits cause crime to increase?
- E. Do known offenders' offending patterns form a representative sample to gauge offence location by development type?

## **The Use construct**

This set of questions looks at crime incidence and the use to which commercial enterprise, mainly recreation is put. It attempts to understand if there is a relationship between crime and the use to which a location is put to, where it occurs, which offences are more prevalent and when they occur.

7. Do town centres host higher crime rates when ranked by category of town centre?
8. Do the results from 'buffering analysis' show differing rates of crimes by type with distance from activity area centre? How far is crime generated by the concentration of the recreational activities?

### 3.4.4 The technical aspect

Creating a first Geographical Information System for the Maltese islands is a major task in its own right. Attempting to take that task one step forward and creating a system to disseminate the results is another.

These questions attempt to investigate whether a Web-based crime-map can be developed for the Maltese Islands.

1. Do web-based crime-mapping systems provide a state-of-the-art service?
2. Can a Web-based crime-map be developed for the Maltese Islands?

### 3.4.5 Summary

The chapter laid the groundwork for the research process through its initial identification of the study objectives. This was aided through its perception that crime cannot be studied in isolation but in conjunction with its related disciplines covering social and landuse issues.

The further development of the study targets was aided through the drawing up of a conceptual model that strove to depict the dynamics of the crime, social and landuse issues, the data available and the linkages between them. The model is extensive and highlights the need for further post-study research and development.

The chapter finally outlined the research questions that will be investigated in the study based on the same crime, social and landuse (CRISOLA) structure. The list looks at those questions that are answerable within the study and those that cannot be answered in the study but are highlighted for future purposes.

Prior to attempting a resolution of these questions, the next two chapters set out the context within which they can be explored. The first discusses the spatial analysis technology, whilst the second sets out a description of the target location: the Maltese Islands.

## Chapter 4: Crime-Mapping and GIS Review

This Chapter examines the discipline concerned with the creation, analysis and visualization of crime data in a spatial format. Crime-mapping, as it is termed, employs state-of-the-art technology and has recently spanned the divide between uniquely physical landuse-based technologies to one that is appropriate for social research. The chapter begins by describing the crime-mapping function through its history, its use of Geographical Information Systems (GIS), and the spatio-temporal function, all based on a socio-technic approach. This section also reviews crime-mapping through a SWOT analysis and then goes on to review web-mapping and the use of latter technology for crime through a review of sites. The final part of this chapter reviews the impact of spatial analysis on social research. This process helps the reader to understand both the use and the process taken.

### 4.1 Crime-Mapping: How it came about

Early studies in spatial patterning of crime and criminality were carried out in the pre-computing era of the early nineteenth century work by Adolphe Quetelet (1796-1874)<sup>24</sup> and Andre Michel Guerry (1802-1866)<sup>25</sup>. These two studies, together with another two unique cases detailed below, proved the power of spatial studies and visualisation whether applied correctly or used inappropriately. Though not strictly employing GIS, these studies employed systematic geographical analysis that was conducted many decades before the invention of computers.

Such was the case of Dr. John Snow in 1854<sup>26</sup> who identified the cause of an outbreak of cholera in Soho London. This was an exemplary case of the use of a pre-computing spatial analysis where a disease was stopped due to the correct identification of a water pump as the main conveyor for the disease. On the other hand, the first abuse of spatial analysis can be attributed to a Governor Elbridge Gerry<sup>27</sup> who in 1812 was accused of redistricting voting aggregations in Massachusetts with the result that the map containing the shrunken-electable concentration of people living in his opponent's support base formed the crude shape of a salamander. From this episode, the word *gerrymandering* was coined to reflect his name and the salamander shape. Interestingly, a case of criminal activity had to be one of the first cases of GI mapping, albeit non-digital.

---

<sup>24</sup> <http://www.mrs.umn.edu/~sungurea/introstat/history/w98/Quetelet.html>

<sup>25</sup> <http://library.tnstate.edu/MARION/ACK-5229>

<sup>26</sup> [http://www.ph.ucla.edu/epi/snow/snowmap1\\_1854.html](http://www.ph.ucla.edu/epi/snow/snowmap1_1854.html)

<sup>27</sup> <http://12.164.81.10/declaration/signers/gerry.htm>

#### 4.1.1 Growth of Crime Analysis Profession

Since then, the analytical methods have evolved and technology has exerted its input to speed up the analytical function. McEwen *et al* (1995) refer to five main points in the growth of the discipline, mainly: i) the shrinking costs of computer hardware and software availability, ii) legitimisation of research and analysis through the conceptualising of community and problem oriented policing, iii) governmental backing, iv) managerial/police chief embracing of the discipline and success stories, v) establishment of professional standards. This is based on a skills, knowledge and abilities approach. One particular organisation, the MAPS<sup>28</sup> programme (previously called the Crime Mapping Analysis Program (CMAP<sup>29</sup>)) has based its approach on the above and even splits its activities around 4 functions: 'i) investigative or crime series analysis, ii) operations research or resource allocation studies, applied research/problem solving, and iv) discrete site analysis such as schools' (Fritz, 2002; 4)

#### 4.1.2 GIS and Crime

Crime Mapping is a successful tool that can be used for a wide range of functions including policy-making, implementation and monitoring interventions on levels of crime and disorder. This can be done through real-time and updated systems that allow crime to be mapped and displayed either on an intranet or on the internet. The latter, through Web-GIS functionality has enabled users to view crime in the neighbourhood as well as report crime on-line (refer to Section 4.1.5). Most current tools still leave much to be desired but they are being improved to an extent that real full web-maps will soon be regarded as the main modus operandi enabling real-time research. The functions enable regular monitoring and updating data, though work is still required to automatically transform that data to information and eventually to knowledge leading to effective policymaking.

Many authors have debated the issue of use of crime-mapping in terms of effectiveness of the technology to aid crime analysis and in turn crime reduction, such as the need to go beyond the hotspot map and delve into the mechanisms of what makes a crime (Chainey, 2004).

The ability of GIS to form an analysis based on a what, why, who, when, where, why not and how phenomena (W6H) outlined by CMAP has helped crime-mapping tremendously. GIS analysts seek to investigate each of the W6H pivots to identify patterns to reach conclusions whether correlations exist or not. The six pivots can be investigated as follows (CMAP, 2002):

---

<sup>28</sup> <http://www.ojp.usdoj.gov/nij/maps/>

<sup>29</sup> <http://www.nlectc.org/cmap/>

- **What** categories of crime were committed? What routines can be identified (category analysis)? What relationships are there between crimes and other variables?
- **Why** did a crime occur? Why did the offender partake in the crime (commonalities of a pattern – root cause of a crime problem)?
- **Who** carried out the crime? Who witnessed the crime? Who was the victim (offender and target profiling)?
- **When** did a crime occur (temporal analysis)?
- **Where** did the crime occur? Where did the offender hail from (geographic analysis – environmental analysis) – (opportunity and routine activity)?
- **How** did a crime occur (deductive approach - classification and modus operandi analysis)?
- **Why not** investigate unrelated variables to elicit if some type of relationship exists (correlation between data layers)?

GIS has facilitated the use of any data using both space and time as a way of producing verifiable information on the patterning and links of crime. As indicated in the W6H structure any data that has a link to a geocoded system can be analysed. In this way GIS has brought to the fore situations where previously non-spatial data (attributes) can now be linked to a spatial dataset and that same data would be integrated into a new GIS layer. Such a structure enables the evolution of thematic data to geographical data (locational data based on points on the earth) to a spatial construct (relationship between entities based on the earth) and across a temporal dimension. Figure 4.1 depicts the different types of analysis that can occur between these four constructs.

Thus GIS has helped the criminology discipline due to its versatility in that theories are readily given the opportunity to be validated or refuted through the creation of previously unavailable data.

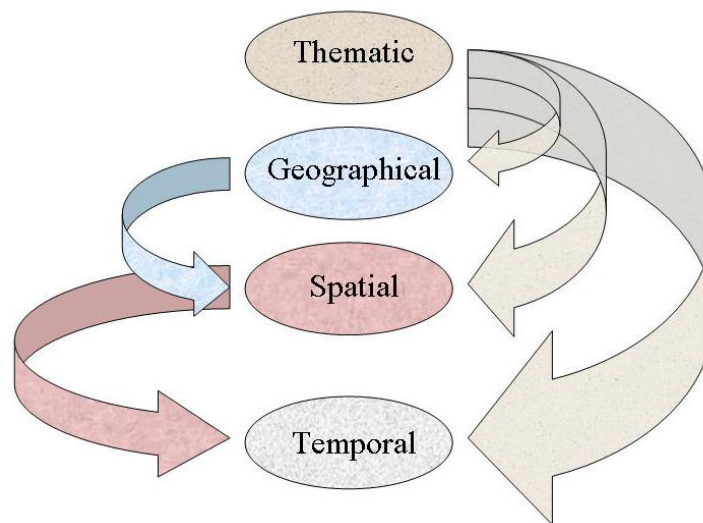
The use of GIS for measuring crime has been deemed to be an inexpensive approach by Hyatt *et al* in their study on the use of GIS on crime in public housing for the HUD<sup>30</sup> (Hyatt *et al*, 1999). However, they state that though the analysis involved appears to be a simple task, this is a very rare form of analysis and needs careful consideration when developing such a study especially

---

<sup>30</sup> H.U.D. – US Department of Housing and Urban Development – Office of Policy Development and Research

since it is a relatively new adjunct to crime analysis. They state that the researcher needs a threefold set of skills: GIS skills, experience in social science research as well as statistical skills.

*Figure 4.1: Analytical Constructs and Dimensions*



Source: The Author

Hyatt *et al* (1999) identify the need for community policing through the use of GIS analysis at the small area (neighbourhood) scale based on cooperative and problem solving initiatives. Though they state the importance of the policing aspect, their methodology for small area analysis is innovative in that they look at very small areas, going away from the very large aggregation data levels usually kept in the US for such studies, where over 1000+ units are studied at any one time.

The initial question rests on the tenet as to whether crime mapping is necessary and even more so, whether spatio-temporal analysis is required. Whilst recent events have overcome the need to prove that crime mapping is an essential tool due to success stories (Woodby, 2003), it is essential that the perspective within which crime mapping operates is retained. Mapping crime can help law enforcement protect citizens more effectively. Simple or complex visualisation options might be used. Simple maps that display the locations where crimes or concentrations of crimes have occurred can be used to help direct patrols to places where they are most needed. Policy makers in police departments might make use of complex maps to observe longitudinal trends in criminal activity, and maps may prove invaluable in solving criminal cases, allowing detectives to use maps to better understand the hunting patterns of serial criminals and to hypothesise where these offenders might reside.

Recent developments in the area of crime mapping show an increased application use by police departments and crime analysts, with interest in crimes by such major entities as the Home Office<sup>31, 32</sup> (UK) and the National Institute of Justice in the US<sup>33</sup>, Interpol<sup>34</sup>, Europol<sup>35</sup>, University of Sheffield<sup>36</sup>, University of Huddersfield<sup>37</sup>, Jill Dando Institute<sup>38</sup>, and the University of Liverpool<sup>39</sup>.

#### 4.1.3 Spatio-Temporal Analysis – An issue of space, time and scale

Crime analysis can only occur within the construct and parameters set out in a particular setting. The level of scale is directly related to the target area. If national statistics are required, the analysis should reflect that level giving generic data, whilst if crime incident level of detail is needed the scale would be very different with exact xy coordinates assigned to each crime location.

One has to note at this stage that crime analysis has to operate within changing geographies of scale which might have a direct influence on the results for each of the different levels investigated. This study investigates crime in the Maltese islands at different levels of scale, from an international (continental) scale to an inter-island national scale (Chapter 7) through the diverse scalar aggregations within the Maltese islands construct from national to regional to local to enumeration areas to street to point levels (Chapters 8 and 9). These different geographies of scale result in different outputs that when reviewed together may not give a comparable result since they are generated using highly-diverse boundaries. Such results may induce the researcher to fall prey to the ecological fallacy as well as base his/her results on boundaries that are not real but have been drafted for socio-economic or political reasons that have nothing in common with geography.

---

<sup>31</sup> <http://www.homeoffice.gov.uk/>

<sup>32</sup> <http://www.crimereduction.gov.uk/technology01.htm>

<sup>33</sup> <http://www.ojp.usdoj.gov/>

<sup>34</sup> <http://www.interpol.int/>

<sup>35</sup> <http://www.europol.eu.int/>

<sup>36</sup> <http://ccr.group.shef.ac.uk/>

<sup>37</sup> <http://www.hud.ac.uk/hhs/dbs/acc/>

<sup>38</sup> <http://www.jdi.ucl.ac.uk/index.php>

<sup>39</sup> <http://www.liv.ac.uk/ecru/>



Spatial analysis of crime requires the use of large-scale mapping<sup>40</sup> in order to build up micro-relationships between different types of crime, such as routine activity/journey-to-crime. This in turn allows the investigation of clusters of crime by type and the identification of route mapping patterns where offenders commit crime based on their routes to work or daily activity. At an increasingly smaller scale one can analyse district and national trends. Law enforcement agencies definitely need large scale data in order to mobilise forces to combat crime whilst crime analysts use the technology to identify underlying relationships and trends.

Temporal analysis is essential for long-term trend evaluation, particularly at different levels of activity such as individual routine-activity and socio-cultural related changes in crime patterns such as movement away from the city centre toward newly built-up areas.

This said, one needs to consider the use to which crime-mapping can be put to and who the interested parties will be. Whilst police forces would need such data for tactical, operational and strategic planning and monitoring, crime data is not solely restricted to police use. Other organisations and individuals may make use and would require crime data, particularly real-time crime-mapping data, for a variety of purposes. These would include insurance officers dealing with incident location and property vulnerability, local government and their neighbourhood watch schemes, regeneration partnerships in their identification of deteriorated areas, businesses in their investment targeting and urban planners in their town-planning exercises. These are but a few examples of the multitude of uses to which crime-mapping can be put.

#### 4.1.4 A S.W.O.T. analysis on the USE of GIS for crime-mapping research

Before one can decide to employ GIS as the main tool in crime analysis, a SWOT (Strengths, Weaknesses, Opportunities and Threats) exercise was necessarily carried out to enable the reader to understand the issues in implementing such a crime-mapping system that does away with the rose-tinted glasses perspective of a one-solution product. GIS as used for crime-mapping has its positive and negative aspects of the technology and its service in a 'crime' construct. The SWOT analysis helps to clarify these issues.

Each part of the process is analysed for its technical, policy-social-environmental and, marketing-economic functions (Table 4.1).

---

<sup>40</sup> Large scale describes very high-detail on a map, for example a street map showing the location of lampposts where 1 cm on a map would refer to 1 meter on the ground. Conversely small-scales refer to small detail where a one-page map can portray the whole EU and 1 cm on the map would represent 500 kilometers.

Table 4.1: SWOT Analysis of the use of GIS for Crime Research

<b>SWOT Analysis of the <u>USE</u> of GIS for Crime Research Strengths, Weaknesses, Opportunities, and Threats</b>	
<i>Strengths</i>	<i>Weaknesses</i>
<p><b>Technical</b></p> <ul style="list-style-type: none"> <li>• Immediate availability of data to analysts, mobile squads, investigators</li> <li>• Queries are automated and pre-formulated letters sent to police chiefs/policy makers</li> <li>• Attribute data available on one single keyboard stroke linked to a map</li> <li>• Routines automate queries and instructions through cross-referencing</li> <li>• Use of Common Database (CDB) eliminating need for redundancy in police databases</li> <li>• Use of buffering analysis and zonal searches can be carried out within single-theme data layers as well as multi-theme layers. Buffering methodology identifies crime within a specific area from the area under study such as offences occurring at a distance of 100m from a school. Zonal searches review crime-patterns occurring at differing distances from the area under study such as crimes occurring every 100m from a bar</li> </ul> <p><b>Policy, Social and Environmental</b></p> <ul style="list-style-type: none"> <li>• Faster analysis of trouble calls</li> <li>• Determination of the effects different crime types have on different physical and socio-economics variables</li> <li>• Crime analysis results can be utilized by a number of disciplines and activities such as real estate estimation, fraud, security companies and social services suppliers</li> <li>• Integration of data from different sources, leading to improvement in rapid reaction delivery and projections based on trends</li> </ul> <p><b>Marketing and Economic</b></p>	<p><b>Technical</b></p> <ul style="list-style-type: none"> <li>• Potential bias by employees in favour of older non-technological systems</li> <li>• Confidentiality issues</li> <li>• Inputting, updating and reading rights are not always adequate - wide access</li> <li>• Distribution of data to a large number of people: staff</li> <li>• Incompatibility with older datasets/systems</li> <li>• Prone to rare but possible data theft or sabotage particularly by “rogue police” – individuals who are employed as police but partake in crime. E.g.: having access to maps of areas of affluence and unprotected areas turns a security map into a treasure-trove of opportunities to an offender – <i>a parallel example refers to corruption cases in development planning in Malta where individuals used applicants’ details to extract monies for satellite-dish permits – case still pending as at 2007</i></li> </ul> <p><b>Policy, Social and Environmental</b></p> <ul style="list-style-type: none"> <li>• Crime is viewed as being the domain of the police rather than social scientists in general – data is kept at a distance through a series of barriers to access the data</li> <li>• Limited support from management and non-technological-oriented chiefs</li> <li>• Lack of understanding by policy makers of the process to mine and analyse data for crime analysis</li> <li>• Lack of skills in information technology and information systems by social science students and practitioners</li> <li>• Crime data is seen as too dangerous to research as it highlights a nation’s weak points or failure in policy making and GI outputs makes it even more dangerous</li> </ul>

<ul style="list-style-type: none"> <li>• Real-time mobile input can be easily updated and defaulters acted upon</li> <li>• Incentives for crime-related organisations to invest in new technologies</li> <li>• Reduction of data entry errors and overhead costs for field-based and office work</li> </ul>	<p><b>Marketing and Economic</b></p> <ul style="list-style-type: none"> <li>• Police Chiefs/Policy makers take time to realize the utility of GIS</li> <li>• High initial cost of hardware and software plus cost of training, cost of managing the GI system, costs of updating the data and costs of answering queries and requests for information</li> <li>• There is no ‘monetary’ profit in these activities and hence refusal to see profit against reduction in staff time to analyse data</li> </ul>
---	---

Source: The Author

<b>SWOT Analysis of the <u>USE</u> of GIS for Crime Research Strengths, Weaknesses, Opportunities, and Threats</b>	
<i>Opportunities</i>	<i>Threats</i>
<p><b>Technical</b></p> <ul style="list-style-type: none"> <li>• Establish a real-time suspect identification system</li> <li>• Link to international datasets such as Interpol/Europol</li> <li>• National and International quick analytical function</li> <li>• Need for the setting up of systems compatible with the mapping agency’s GIS allowing future exchange of data</li> </ul> <p><b>Policy, Social and Environmental</b></p> <ul style="list-style-type: none"> <li>• Identification of specific areas of hot-spots, criminogenic areas</li> <li>• Provide progressive crime-reduction environment</li> <li>• Work towards Neighbourhood Schemes data sharing</li> <li>• Identification of potential needs by victims for patrols enhancements</li> </ul> <p><b>Marketing and Economic</b></p> <ul style="list-style-type: none"> <li>• More police on beats, less time in office allowing more efficient and effective policing</li> <li>• Wide availability of data to other</li> </ul>	<p><b>Technical</b></p> <ul style="list-style-type: none"> <li>• Inputted crime data is not updated regularly</li> <li>• Changes in categorizations can lead to incomparable results</li> <li>• New hardware can make whole systems obsolete</li> <li>• Project stoppage midway through completion</li> </ul> <p><b>Policy, Social and Environmental</b></p> <ul style="list-style-type: none"> <li>• Data is mishandled and convict/suspect data is misused by rogue police / newspersons</li> <li>• Political and economic uncertainty impede investment</li> <li>• Poor timing of decision making</li> <li>• Assumptions can be “mistaken” leading to wrong and costly decisions</li> </ul> <p><b>Marketing and Economic</b></p> <ul style="list-style-type: none"> <li>• Data sold/bought at exorbitant prices that do not reflect reality (includes social data)</li> <li>• Real-time analysis needs real-time</li> </ul>

<p>crime-related agencies for inter-disciplinary data exchange</p> <ul style="list-style-type: none"> <li>• Spin-offs of the attribute section of data</li> <li>• Allows time-scheduling - third parties are better served</li> </ul>	<p>updated 3rd-party data exchanges that reflect the ground-truth such as new development, new transport routes</p>
---	---

Source: The Author

This analysis shows that there is no sure-fire way to develop a foolproof GIS crime-mapping system. As with other processes it strives on as well as suffers from the functional, analytical, administrative and human-related issues as experienced by other software-applications. However, as listed in the Strengths and Opportunities, the pros far outweigh the cons, thus enriching the whole spectrum of crime-related functionality.

#### 4.1.5 Web-mapping and Crime

With the introduction of mainstream GIS and the subsequent development in the mid-1990s of the Internet, it was only a matter of time before web-mapping sites began to appear. Crime web-mapping has followed suit albeit at a slightly slower rate and the number of sites are growing though they vary from simple image-mapping deliveries to full-blown Web-GIS applications.

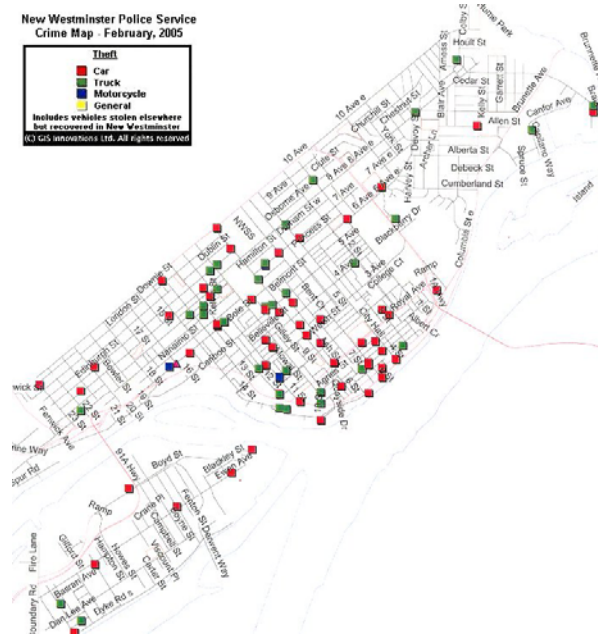
As part of this study, the author researched whether a GIS crime-mapping system exists in Malta and whether a web-mapping crime system was available for consumption over the internet. In both cases, research resulted in the negative, with particular disappointment on the web-mapping sector where very few sites exist worldwide and none in Malta. This exercise as reviewed below was carried out with the scope to create a benchmark of excellence for web-crime-mapping and which sites would serve as a base for the creation of a Maltese site by the author following the conclusion of the research as well as highlight the options available to crime-researchers in their efforts for data dissemination. Based on the sites review and on the availability of spatial data emanating from this study, a prototype Malta Crime website was developed by the author and is categorised according to the benchmarking exercise.

Table 4.2 reviews a number of sites that attempt to depict a crime web-mapper. The sites were chosen following a web-trawl of sites related to web-mapping and crime-mapping in particular. An award criteria was set up to find the best site, which process is described below.

The sites were reviewed for their interactivity through a Web-GIS level analysis delivering GI functionality over the internet. This is split up into simple images with no interaction (Figure 4.2), image-maps with simple interaction such as clicking on a point and accessing data (Figure

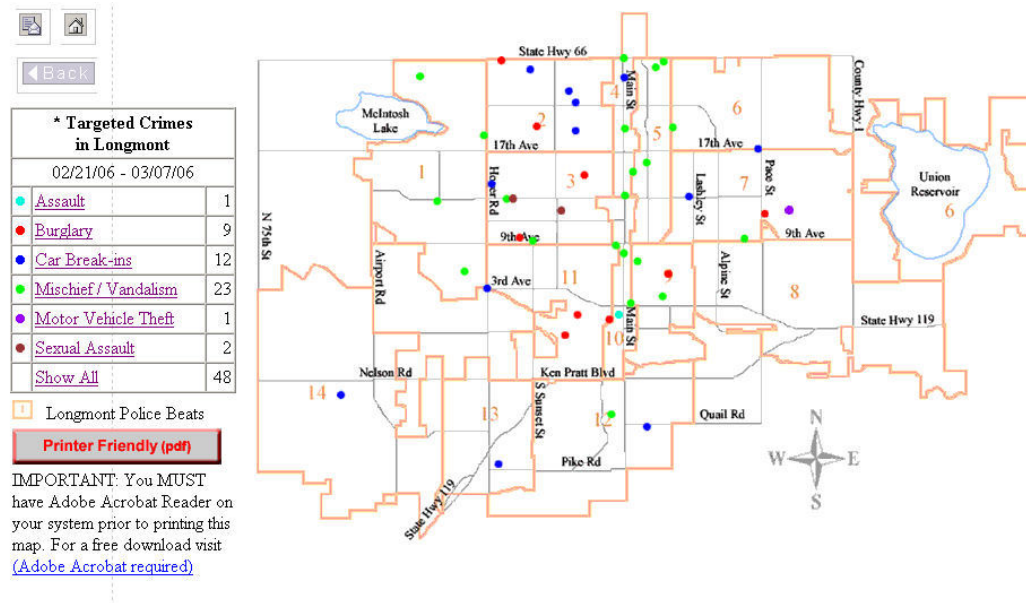
4.3), real Web-GIS functionality with limited querying functionality (Figure 4.4) and full Web-GIS with full querying functionality (Figure 4.5). The sites were categorised by these levels and relevant comments on accessibility and limitations are given.

Figure 4.2: Web-GIS Example - No Interactivity



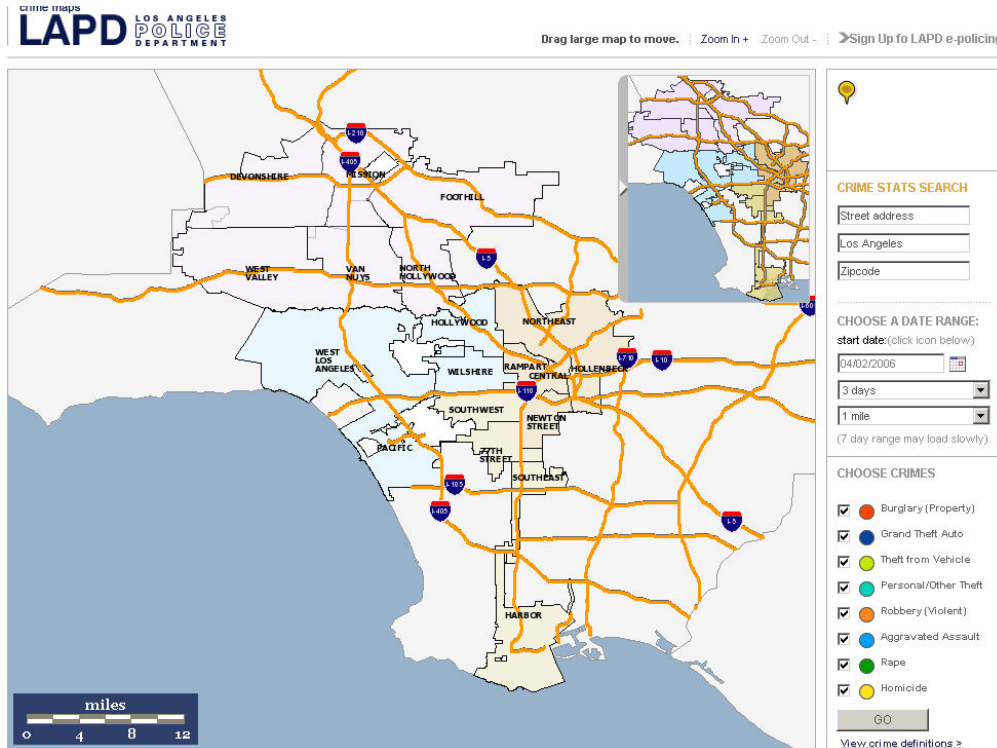
Source: <http://www.nwpolice.org/images/crimemap-theft-02.jpg>

Figure 4.3: Image-maps with simple interaction



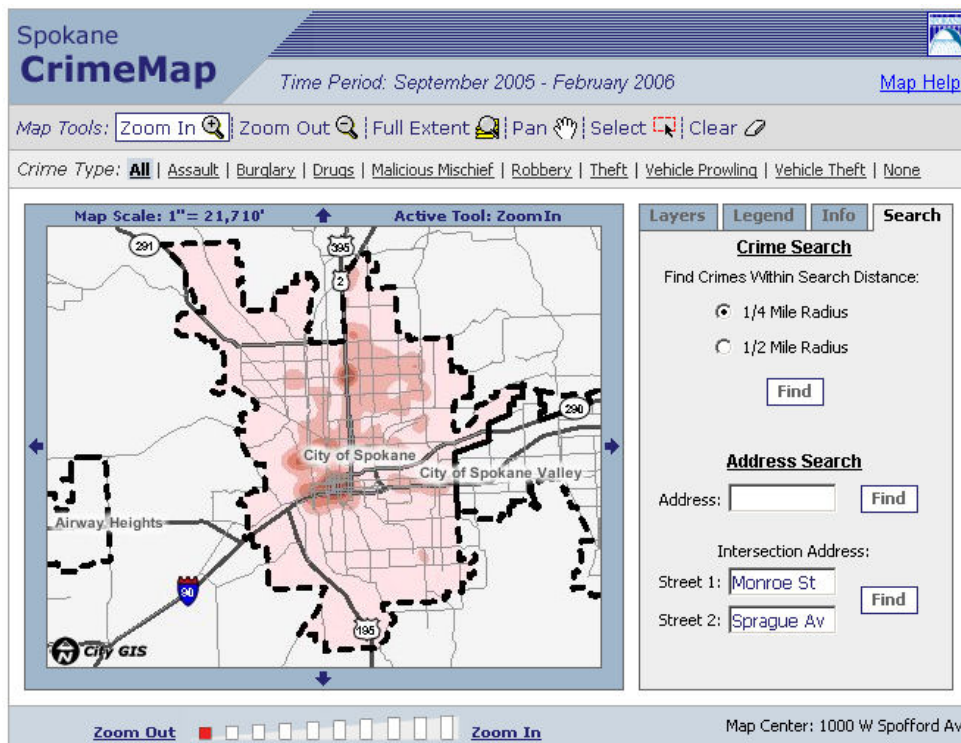
<http://www.ci.longmont.co.us/police/crimeupdate/map.htm>

Figure 4.4: Real Web-GIS functionality with limited querying functionality



<http://www.lapdonline.org/crimemap/>

Figure 4.5: Full Web-GIS with full querying functionality



<http://www.spokanegis.org/crimemap/default.asp>

Table 4.2 also categorises the nineteen sites by region of origin, mainly World, EU, USA and Others. Whilst one generic site of world coverage is depicted, the main trust is found in the USA with 14 sites. The EU is still lacking in this field with only 3 sites published, whilst the other category reviews a Canadian site. This is an area that has yet to be exploited and one must investigate the reasons why so few departments go for a web-map.

*Research Question: Do web-based crime-mapping systems provide a state-of-the-art service?*

Table 4.2 also carries a further process, where a star-awarding exercise has been carried out for this study with a 1-star signifying an informative site but with limited if any interactive use, whilst at the other end a 5-star signifies a ‘state of the art’ site. The latter would allow full-interactivity, a querying function and full map generation.

*Table 4.2: League-Table of sites that have a Web Crime-mapping component*

Country	Site Name	Web-GIS Level				Address	Comments	Limitations	Star Rating
		Static Map – No Interaction	Basic Image-Mapping – Little Interaction	Web-GIS - View with Interaction	Full Web-GIS – Query Option – Full interaction				
World	Maps of the World					<a href="http://www.mapsofworld.com/world-top-ten/countries-with-lowest-reported-crime.html">http://www.mapsofworld.com/world-top-ten/countries-with-lowest-reported-crime.html</a>	Imagemap with crime maps of countries in the world	Very limited in scope	1
EU	European Commission Crime Map					<a href="http://www.coe.int/T/E/Com/Files/Themes/Organised-crime/map.asp">http://www.coe.int/T/E/Com/Files/Themes/Organised-crime/map.asp</a>	Published GIS map	No interaction	1
EU	European Regional Crime Database					<a href="http://www.tu-darmstadt.de/fb/fb1/vw12/deutsch/inhalte/forschung/eucrimedata.html">http://www.tu-darmstadt.de/fb/fb1/vw12/deutsch/inhalte/forschung/eucrimedata.html</a>	Imagemaps based on what is essentially a database	Database is highly useful, maps are for visualisation purposes only - no interaction	2
EU	Misdaadkaart.nl - Dutch Crime Map					<a href="http://www.misdaadkaart.nl/">http://www.misdaadkaart.nl/</a>	Uses Google Maps	In Dutch	4
USA	ARJIS - San Diego Police Department: Crime Stats & Maps					<a href="http://www.arjis.org/mapping/help/disclaimer.html">http://www.arjis.org/mapping/help/disclaimer.html</a>	Queryable map through interactive clicking and area queries/attribute queries	Clicking on point data is difficult	4



Country	Site Name	Web-GIS Level				Address	Comments	Limitations	Star Rating
		Static Map – No Interaction	Basic Image-Mapping – Little Interaction	Web-GIS - View with Interaction	Full Web-GIS – Query Option – Full interaction				
USA	Cambridge Police Department					<a href="http://www.ci.cambridge.ma.us/~CPD/crime/wchssa.html">http://www.ci.cambridge.ma.us/~CPD/crime/wchssa.html</a>	Image of crime location and textual description in webpage	Very little interaction with site - maps form part of report	1
USA	CITIZEN ICAM (Information Collection for Automated Mapping) - The Chicago Police Department					<a href="http://12.17.79.6/ctznicam/ctznicam.asp?cmd=addr">http://12.17.79.6/ctznicam/ctznicam.asp?cmd=addr</a>	Search engine that launches a high-end crime tool, inclusive of large scale hotlinks of individual crime locations. Viewable maps, graphs, and tables of reported crime.	Query tool displaying result in map format. Database has 90 days of information. Most recent information is back-dated 7 days from access date.	4
USA	City of Portland CrimeMapper					<a href="http://www.gis.ci.portland.or.us/maps/police/index.cfm">http://www.gis.ci.portland.or.us/maps/police/index.cfm</a>	Search engine based on a valid street address, intersection or address that returns a map of crimes within that location.	The search feature displays crime occurrences at small scale rather than at address point detail.	3
USA	City of Seattle					<a href="http://www.am.org/crimemap/crimemap.htm">http://www.am.org/crimemap/crimemap.htm</a>	GIS results of Seattle	No interaction	1
USA	Longmont Police Department					<a href="http://www.ci.longmont.co.us/Police/crimeupdate/index.htm">http://www.ci.longmont.co.us/Police/crimeupdate/index.htm</a>	Very basic site with choice of crimes and imagemap given - no real interaction with map	Very limited in querying	2
USA	Los Angeles Police Department					<a href="http://www.lapdonline.org/crimemap/">http://www.lapdonline.org/crimemap/</a>	Query by street and choice of crime category, up to last 7 days	Not all crimes are listed. Limitations also due to last 7 days data availability. Zooming function cumbersome	3
USA	National Archive of Criminal Justice Data					<a href="http://www.icpsr.umich.edu/NA/CJD/GIS/resources.html">http://www.icpsr.umich.edu/NA/CJD/GIS/resources.html</a>	Crimemap Tutorial, not a real crimemapper webpage, some imagery	Tutorial - not an online page	1



Country	Site Name	Web-GIS Level				Address	Comments	Limitations	Star Rating
		Static Map – No Interaction	Basic Image-Mapping – Little Interaction	Web-GIS - View with Interaction	Full Web-GIS – Query Option – Full interaction				
USA	Sacramento Police Department: Crime Mapping System					<a href="http://maps.cityofsacramento.org/website/sacpd/">http://maps.cityofsacramento.org/website/sacpd/</a>	Highly effective map showing attributes resultant from a query. Allows querying by date, report number, area, amongst others	3-months data period possible within query	4
USA	Salinas Police Department: Geographic Information Systems					<a href="http://crimemap.ci.salinas.ca.us/">http://crimemap.ci.salinas.ca.us/</a>	Allows choice of map type, query type and crime categories and distributes attribute data	Map sometimes does not display	4
USA	San Antonio Police Department					<a href="http://maps.sanantonio.gov/web/site/COSAMaps/viewer.htm">http://maps.sanantonio.gov/web/site/COSAMaps/viewer.htm</a>	Map viewer for city with safety map. Not highly interactive and no real crime data	Maps not interactive - the interactive section does not work	2
USA	San Francisco GIS					<a href="http://gispubweb.sfgov.org/web/site/san_francisco_community/wizard.asp">http://gispubweb.sfgov.org/web/site/san_francisco_community/wizard.asp</a>	Very dynamic and highly queryable. Multiple layers of data and extensive legend. User-friendly and fast.	Few if any limitations. State of the art. Maybe sub-categories and a help file with street names would cap it...	5
USA	Spokane City					<a href="http://www.spokanegis.org/crimemap/">http://www.spokanegis.org/crimemap/</a>	Highly interactive tool allowing multiple-category analysis and zooming/panning facilities	Few if any limitations. State of the art. Maybe an increase in sub-categories would tweak it finer...	5
USA	Tempe Police Department					<a href="http://www.tempe.gov/cau/">http://www.tempe.gov/cau/</a>	Images depicted as crime choropleths. Series of images depicting beat maps.	Non interactive	1
Canada	New Westminster, British Columbia, Canada					<a href="http://www.nwpolice.org/maps.html">http://www.nwpolice.org/maps.html</a>	Pre-prepared GIS maps	Very limited	1

Source: The Author

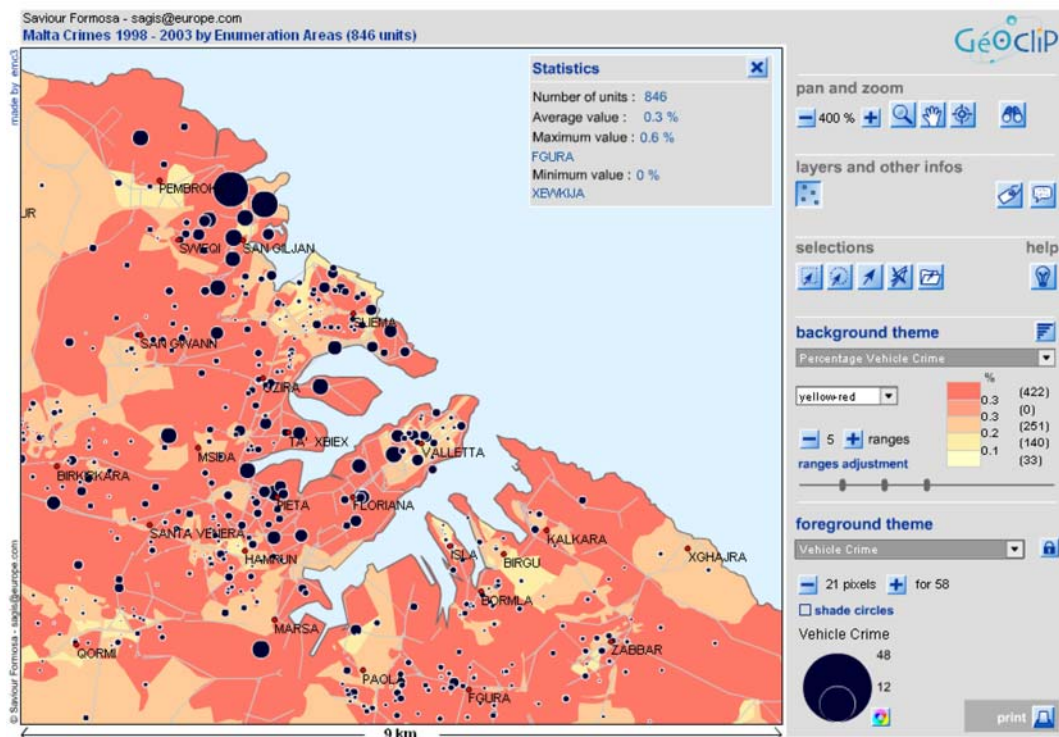
*Research Question: Can a Web-based crime-map be developed for the Maltese Islands?*

Based on the above benchmarking exercise, the different options available to the author were identified and a local crime-mapping site developed. The technology employed is based on a

MapInfo mbx programme developed by *emc3*<sup>41</sup>, which uses Flash (swf) technology as its spatial carrier. Users can interact with the mapped data in a format they are already familiar with when browsing the internet. Simple help files are also available and guide the user on how to interact with the crime-map. Such a new approach is a major improvement from the early technologies of image-mapping and GIS-Client that required extensive downloading sessions. It is also an improvement as against a full map-server function that requires a remote and potentially heavy site (Formosa, 2000). Flash technology enables integration of the GI datasets and maps within a very small and simple flash file that can be conveyed easily over the web and even used on a standalone computer.

The prototype site created by the author encompasses a Web-GIS view with interaction on a number of variables such as police-reports crimes from 1998 to 2003, vehicle crime, serious and non-serious crime, amongst others. In terms of benchmarking, it is tagged with a 3-star rating for its pre-prepared structure that at the same time allows extensive user interaction such as personalised map creation and outputting. Figure 4.6 depicts the Malta Crime Web-GIS created for this study ([www.crimemalta.com](http://www.crimemalta.com)).

Figure 4.6: Malta Crime Web-GIS prototype



Source: The Author : [www.crimemalta.com](http://www.crimemalta.com)

<sup>41</sup> <http://www.geoclip.net>

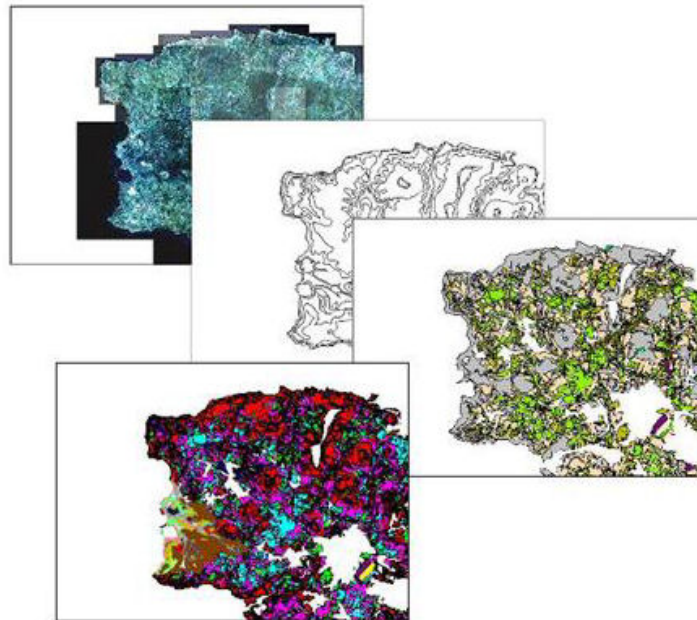
Following the above review of crime-mapping and the use to which it could be put in criminological research, the next step looks at the technology behind it all.

#### 4.2 Spatial analysis and its impact on social research

Crime analysis takes up different forms, from physical pin charting to use of textual documentation to use of tabular data and eventually to the use of crime statistical tools and GIS, aided by value-added modules that cater specifically for crime.

Social-scientific research to date has depended on textual and tabular data that is rarely analysed in a spatio-temporal setting. The use of spatial and temporal analysis of crime data has enabled analysts to combine different resources stored in various formats into a coherent system. With GIS technology, analyses that were not possible in the traditional sense can be identified due to 'its ability to compare multiple geographic factors and investigate geographic correlations' and identify the root cause of a problem (Bruce, 2002: 25). It also has the ability to unravel a complex issue that may be too difficult to investigate using conventional or paper-based methods. GIS aids researchers to generate new knowledge through the use of cross-data analysis such as land zoning and offence location through the concept of layering (connected by a common frame of reference system known as x/y coordinates) (Figure 4.7).

*Figure 4.7: Layering Concept*



Source: MEPA, 2005 - layers depict from bottom to top: aerial imagery, geology, agriculture and habitats

Problems with very large datasets can be overcome through the concept of multiple layering and distributed access to data. The layering issue brings together multi-source data such as, for example, the visual analysis of poverty concentrations based on an analysis of economic data such as income and dilapidated dwellings, burglary and street lighting, drugs partaking and bars, thefts and egg-roll carts drug-cover schemes (Woodby, 2003). Better still, this analysis can be carried out in a time-series process to create a spatio-temporal output, effectively identifying trends and helps in recommending policy change.

#### **4.3 Need for information systems: where was the need for GIS highlighted**

Way back from the 19<sup>th</sup> Century of Quetelet, the need for information systems that cater for specific areas of study has long been felt, particularly in the attempts to identify crime patterns through the use of wall maps and coloured pins. Even before the advent of computing, researchers identified that the main point of contention with this methodology was that few persons could effectively identify trends based on variables such as crime type, time and relationship to other crime locations. The technology was very basic and limited and progressively needed other methods such as flash card, catalogues, calculators, spreadsheets or databases to cater for the research demands. This brought about a need to develop digital spatial information systems, better known as GIS.

For a detailed description of GIS technology and its input to crime, review Appendix 2. The following sections outline the important aspects where GIS input to crime analysis is deemed essential to this study.

- Integration of GIS and statistical tools

Major improvements in the analysis area have occurred during the last few years and tools have been developed that carry out statistical research in a spatial construct. These software include such examples as CrimeStat<sup>42</sup> (Levine, 2002). These software, together with other specialised tools such as SPSS and SAS help users to create new information that aids in the verification or refutation of hypotheses.

In addition, specialised tools have been developed by major software companies providing evidence that the commercial sector has seen ways to profit from “crime”. Tools in the private

---

<sup>42</sup> *CrimeStat*<sup>®</sup> is a spatial statistics program for the analysis of crime incident locations, developed by Ned Levine & Associates under grants from the National Institute of Justice (grants 1997-IJ-CX-0040 and 1999-IJ-CX-0044). CrimeStat allows the analysis of standard deviation maps, attribute analysis, journey to crime, hotspot analysis and a series of spatial statistical measures – <http://www.icpsr.umich.edu/NACJD/crimestat.html>

and public domain include ESRI products (Crime Extension)<sup>43</sup>, MapInfo<sup>44</sup> (Hotspot Mapping Extension<sup>45</sup>), Vertical Mapper, and related products.

In their study on Sheffield, building up on the earlier 1990s studies by Bottoms and Wiles, Craglia *et al* (2000) used SAGE<sup>46</sup> and STAC<sup>47</sup> programmes. They used the software for the analysis of offence data, offender data as well as victim data. The use of GIS for the analysis of crime was building up on the earlier practice of analysis using spreadsheets and databases together with street-level data (Rich, 1995). This has helped to develop a base for the study of crime through high-end software.

- Interpretation measures

Although primarily GIS was developed as a physical discipline analysis tool it is being used as an analysis tool in the social science arenas. Helms (2002, 8-9) identified that crime analysis cannot happen without a wide-ranging overview of the components of a crime: space, time, behaviour, target and offender. Each of these contributes to both a physical as well as a sociological/psychological construct. Whilst each can to a certain extent be analysed through GIS, it is imperative that researchers delve deep into the relationships between all these to dissect the issue at hand.

Whilst sociology is concerned with the study of relationships, environmental criminology delves into a broadside analysis of crime at all levels of the relationship spectrum. Social interactionism is composed of myriad interactive packets, mainly: person-person, person-group, person-organisation, person-state, group-group, group-organisation, group-state, organisation-organisation, organisation-state, and state-state: is crime similarly related? It is interesting to note that these interactions are quite complex and widespread from a simple case of theft of a bag at the person-person level to an organizational-state activity such as company fraud to a state-state level issue such as illegal immigrant activity.

---

<sup>43</sup> [http://www.esri.com/industries/lawenforce/crime\\_analysis.html](http://www.esri.com/industries/lawenforce/crime_analysis.html)– Product such as ArcGIS is a generic GIS that can accept extensions. These applications allow the use to create new maps, analyse the spatial and attribute data as well as having the full functions of a GIS.

<sup>44</sup> <http://www.mapinfo.com> – MapInfo is a generic GIS that can accept extensions. It is a vector based product used for this study, which software allowed the mapping, analysis, geocoding, overlaying and other functions required for the study. Mapinfo's extension, Vertical Mapper was used to generate the 3D and grid-maps for spatial analysis requirements

<sup>45</sup> <http://www.jratcliffe.net/ware/index.htm> - extension by Jerry Ratcliffe enabling hotspot generation and analysis

<sup>46</sup> SAGE (Spatial Analysis in a Geographical Environment) was produced under ESRC research grant R000234471 'Developing spatial statistical software for the analysis of area-based health data linked to a GIS' (Craglia *et al*, 2000) - <ftp://ftp.shef.ac.uk/pub/uni/academic/D-H/g/sage/sagehtm/sage.htm>

<sup>47</sup> STAC – Space and Temporal Analysis of Crime software was developed by the Illinois Criminal Justice Information Authority (ICJIA). A users manual is available: Users Manual and Technical Manual, (1996), Chicago, IL: ICJIA

One issue that begs discussion concerns interpretation of the available results. Hyatt *et al* (1999) point out that the maps resulting from a study in crime can indicate the wrong message. Interpreting a map based on drug arrests may in fact reflect only where the resources are situated. A route with high drug arrests may not indicate a concentration of drug trafficking locations but the police mobile route.

Craglia *et al* (2000), used address point data as their main spatial level, where they state that problems with ‘fuzziness’ occurred when data was not located in the correct location. Another problem also included the locations of crime that are given an ‘extended’ address rather than a specific point. For example car thefts are usually designated a street location, rather than the exact spot they occurred in. This poses a problem since streets can stretch practically right across a town or village, such as in the Maltese situation. Does one locate the crime at the exact centre of the street line potentially misplacing the location and creating crime areas where they do not exist with the resultant diversion of services (Ireland, 1998; Hirschfield *et al*, 1997)? The methodology used in this study was based on random dispersal along a street centreline buffer (refer to Chapter 6). Also, is this a necessary evil considering that at the dissemination stage web-maps rarely pinpoint exact locations?

In addition, street data does not include which side of a street a crime occurred, theoretically rendering analysis difficult since one side of the street could be taken up by retail activity, whilst the other side is a residential area. Hyatt *et al* (1999) identified this and included both sides of a street to analyse crime patterns in their blockface study arguing that rarely does crime stop at only one side of a street.

The above topics identify GIS as a complex technology that has come to age at a crucial time for crime-analysis, allowing the analysis of large datasets through its crime-mapping technique and enabling dissemination through web-mapping technology.

#### **4.4 Summary**

Crime analysis underwent a rapid evolution through the introduction of GIS technology and the spatio-temporal techniques it launched due to its versatility in handling large-volume and diverse datasets spread across multi-disciplinary areas.

Different methodologies have been investigated as well as an analysis given of the types of measures that GIS employs to analyse crime. Crime is a dynamic and ever flowing river in a

socio-economic/socio-cultural highly volatile field as it is based on the psychological makeup of the various persons involved in crime from the offender, through the victim through law enforcers, to the analyst. The only way to analyse such a situation is to use a technology that would allow for fast-track real-time tactical analysis as well as macro long-term strategic analysis, an option serviced by GIS.

The use of specific statistical tools integrated within GIS or as an add-on module has indicated that crime-analysis can go beyond mere mapping of hotspots towards an in-depth analysis of the spatial and temporal aspects of crime. This can be carried out through an understanding of the spatial components of an area, the landuse parameters the data operates in, the social issues involved and finally understanding how the crime aspect can be interpreted against each of these, either through cross-sectional or longitudinal studies.

Finally, GIS has enabled dissemination of data to a wider audience, through web-enabled crime-mapping, even though this technology is still in its infancy.

This chapter outlined the development of GIS and crime-mapping and how it can be used to gather data, analyse and deliver results leading to an understanding of crime issues. The next chapter explores the scene within which the crime and GIS research will operate; that of the Maltese Islands.

## **Chapter 5: The Maltese Scenario: Setting the Scene**

### **5.1 Dynamics of Maltese society: Overview of historical issues**

#### **Introduction**

This chapter gives an introduction to the Maltese scenario, through an in-depth exploration of the physical, socio-economic and socio-cultural profile of the Islands. A review is given in a generic context to lay the foundation for spatial analysis in Malta. Chapter Five was included for very specific reasons, mainly due to the fact that such a study cannot be analysed without an in-depth knowledge of a country's socio-cultural and socio-economic contexts. Offences occur within a particular social construct and the Maltese Islands have their own peculiarities, being insular, having had a diversified history, experienced rapid social change and in turn saw a dynamic offender and offence component. It is imperative that the reader (local or international) understands the island's sociological composition (political, religious, economic, family and educational, as well as environmental) prior to attempting to understand how the offender-offence interactivity operates. Such changes as the transformation from a military to a service economy, the increase of affluence, the landuse-related decision making, amongst others, have all had an impact on society. These changing characteristics over the past fifty years have influenced both the opportunity structure for, and the occurrence of, crime in Malta over this time period. This is demonstrated further in the analysis chapters 8 and 9, which deal with offenders and offences respectively.

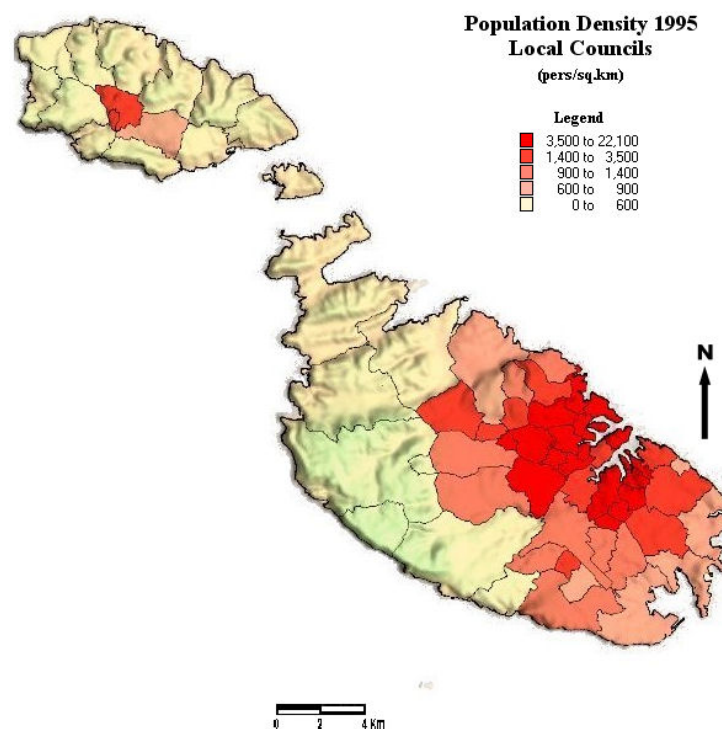
The Maltese archipelago consists of 3 main islands and a number of lesser islands and islets situated in the central Mediterranean, 90 km south of Sicily and 400 km north of Libya. Malta has an area of 246 km<sup>2</sup> (27.4 km by 14.5 km), Gozo has 67 km<sup>2</sup> (14.5 km by 7.2 km) and Comino is 3 km<sup>2</sup>. Malta is highly populated (360,000 persons) as against Gozo which has a relatively low population (30,000 persons) and Comino's single family residence. National population density is 1,200 persons per km<sup>2</sup> which varies from a minimum of 74 persons per km<sup>2</sup> in Ghasri (Gozo) to 22,066 persons per km<sup>2</sup> in Isla. Figure 5.1 shows a topographic population density map of the Maltese Islands during the 1995 Census and Figure 5.2 depicts the data in 3D Prism format. Note the high densities around the Grand Harbour within what can be termed the conurbation, particularly the small walled city of Isla (spike in Figure 5.2).



Climate-wise, Malta is typically Mediterranean with hot dry summers and short cool winters with temperatures averaging 18° Celsius and ranging from 12° to 42° Celsius.

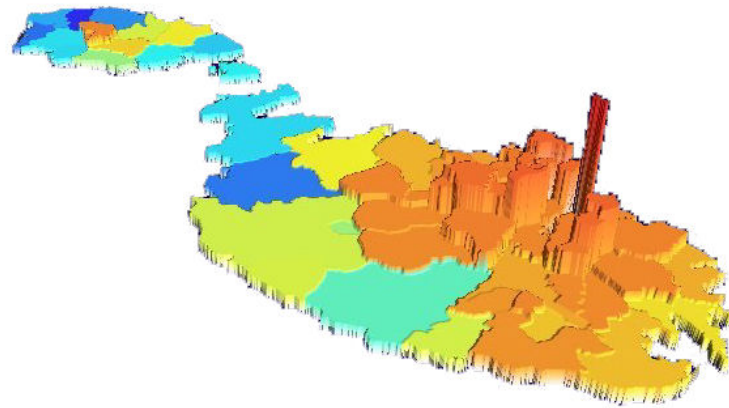
Historically, the long periods of colonization have undoubtedly left their mark, from the Phoenician, through the Roman, Arab, French and British, amongst others. Some left massive infrastructural legacies such as the Knights of St. John who built fortified cities and buildings, whilst others left a virtual presence such as the Arabs, whose only remnant is the Maltese language which has a semitic base intertwined with words and expressions from the languages of the colonisers who followed. To add more spice, the large number of prehistoric temples whose unknown origin have left large gaps in explaining the prehistoric aspect that leave an aura of mystery on Maltese culture.

*Figure 5.1: Population Density Map – 1995*



Source: Formosa, 2000 - [http://www.mepa.org.mt/Census/archive/age/Pop Density/popdens.htm](http://www.mepa.org.mt/Census/archive/age/Pop%20Density/popdens.htm)

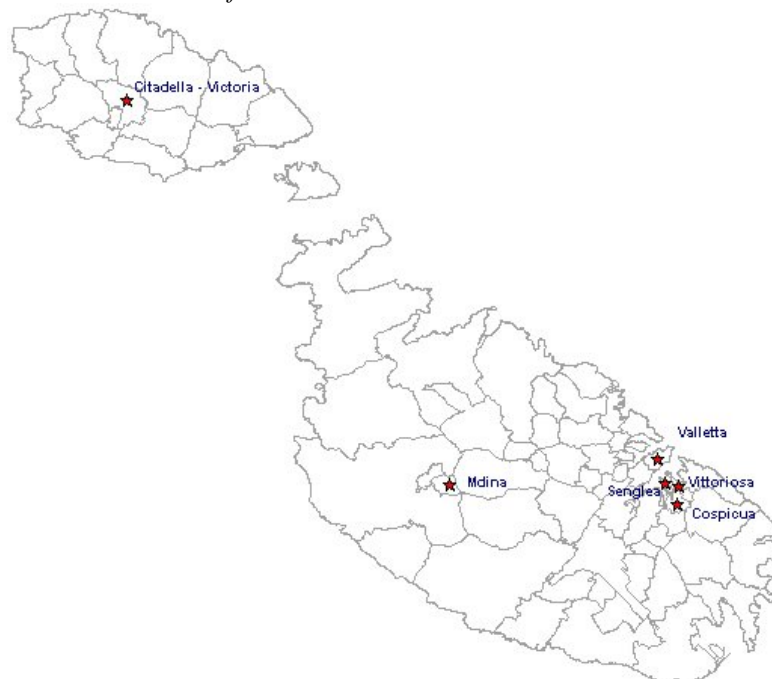
Figure 5.2: 3D Prism Population Density Map - 1995



Source: Formosa, 2000 - [http://www.mepa.org.mt/Census/archive/age/Pop Density/popdens.htm](http://www.mepa.org.mt/Census/archive/age/Pop%20Density/popdens.htm)

The medieval cities also played a major role on the economic and social structures through the centuries and currently still play a vital role that goes beyond the infrastructural state but delves into the impact of these cities on crime and vice-versa. The maritime cities of Valletta, Birgu, Isla and Bormla feature highly in such scenarios and are tackled in depth in this study (Figure 5.3). Older walled cities such as Mdina and the Citadella in Gozo have declined in importance and host very few people with minor roles in offender and offence crime.

Figure 5.3: Walled Cities of the Maltese Islands



Source: The Author

Politically, Malta is relatively a newcomer on the independent nations scene, having been colonised for thousands of years. Gaining Independence in 1964 and becoming a Republic in 1974, Malta joined the European Union in 2004 having passed a series of elections and a referendum on the subject. Malta is a parliamentary democracy, with the President serving as a symbolic head of state. At a lower level, centralised power is slowly giving way to decentralised activities with Local Councils<sup>48</sup> (administrative units) taking up some of the functions of the state. They were established on the 30th June 1993 through the [Local Councils Act](#), 1993 (Act No. XV of 1993) and entrenched in the Constitution in 2001<sup>49</sup>.

Initially 67, currently there are 68 councils as Mtarfa<sup>50</sup> was extracted from Rabat Malta in 2000, with 54 councils in Malta and 14 in Gozo, with Comino delineated as part of Ghajnsielem in Gozo. Although councils can be deemed autonomous, they are responsible to the Ministry of Local Councils and the Department of Local Councils that ensure that the Local Councils have the legislative authority to respond to local needs as well as helping in management, administrative support and funding. Councils have their own tribunals for local offences such as littering, and traffic infringements. It is these Local Councils (NUTS 5<sup>51</sup>) that serve as a base for analysis in this study.

#### 5.1.1 Demographic issues: Density, Local and Foreign population component

Demographic structure affects directly and indirectly the socio-economic, socio-cultural and also infrastructural scenarios particularly in small states. Such impacts include limited land use, household sizes and the provision of space for housing, (particularly social and affordable housing), social and community facilities, leisure and recreation, as well as transport and utilities (Tabone, 2001).

The Maltese Islands' population is going through a stage that is late transitional and is entering the scenario where the growth rate is gradually edging towards zero. This is due to the effect of low birth rates and an ever increasing longevity. Both birth and mortality rates have seen a steady decline over the years and the effect is already evident where more than 19% of the population is aged over 60 years and is expected to reach 25% in 2020 (MEPA Demographic Topic Paper, 2001). Figure 5.4 depicts the population pyramids of the Maltese Islands between 1957 and 1995 from past Censuses and projections for 2010 and 2020. The pyramids show that

---

<sup>48</sup> <http://mjha.gov.mt/ministry/localgovt.html>

<sup>49</sup> Act No. XIII of 2001 established that: "The State shall adopt a system of local government whereby the territory of Malta shall be divided into such number of localities as may by law be from time to time determined, each locality to be administered by a Local Council elected by the residents of the locality and established and operating in terms of such law as may from time to time be in force."

<sup>50</sup> <http://www.mtarfa.gov.mt/locality1.asp>

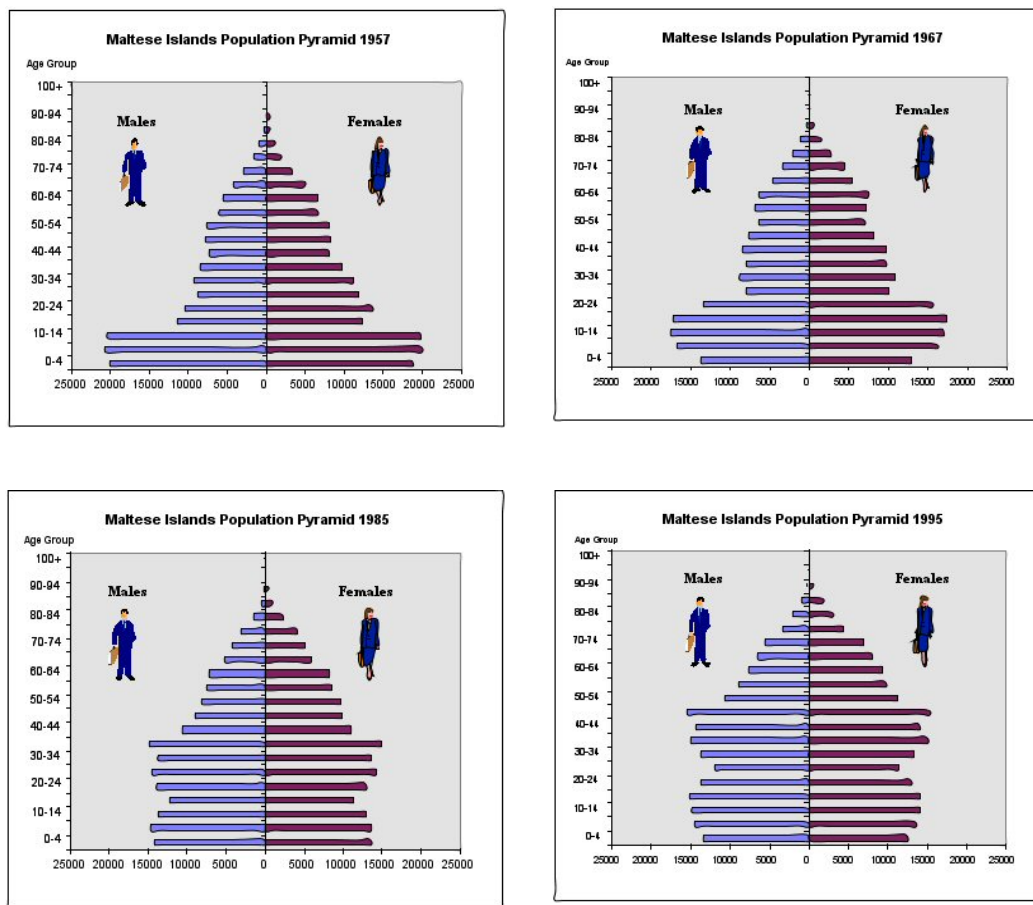
<sup>51</sup> Nomenclature des unites territorielles pour statistique – European Union Classification

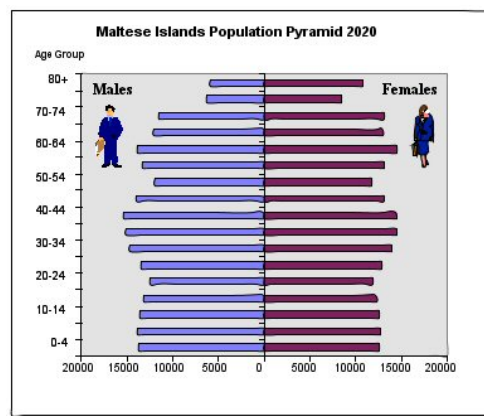
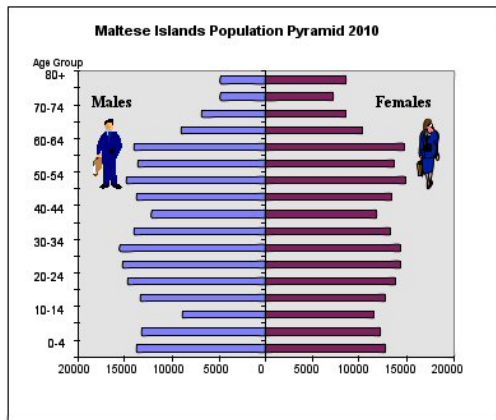
the Maltese structure has moved from a bottom-heavy young-aged population in 1957 to a projected top-heavy elderly based structure in 2020.

As regards to life-expectancy, Malta falls within the top range quite highly having registered 77.5 years (for both sexes) in the late-1990s. These levels compared to Italy's figure in the mid-90s, Sweden in the early 1990s and the UK in 2000.

The Maltese Islands have seen a steady decline in fertility rates since 1985 even falling below replacement ratio (2.1) in 1995. Large families are slowly reducing in number and families with one or two children are the norm (53% of all mothers) (COS, 1997). This is due to a variety of reasons amongst which socio-economic change and increased secularisation has been influential. Lifestyle preferences, consumer-oriented environment, parents' desire for self-satisfaction, educational opportunities and more opportunities for women to seek a job have contributed to this factor (Sultana *et al*, 1994; Troisi, 1995; Abela, 1992; Tabone, 1995; Tonna, 1995).

Figure 5.4 Population Pyramids of the Maltese Islands between 1957 and 1995 (2010-2020 projected)





Source: Author and MEPA, Population Pyramids Data 1957-1995, Demographic Topic Paper, 2001

Demographic changes have a direct impact on the structure of households. Maltese household size has shrunk rapidly from 4.1 in 1957 to 3.1 in 1995. This is resulting in a larger number of smaller households (119,479 in 1995) and direct calls for more housing to accommodate these changes.

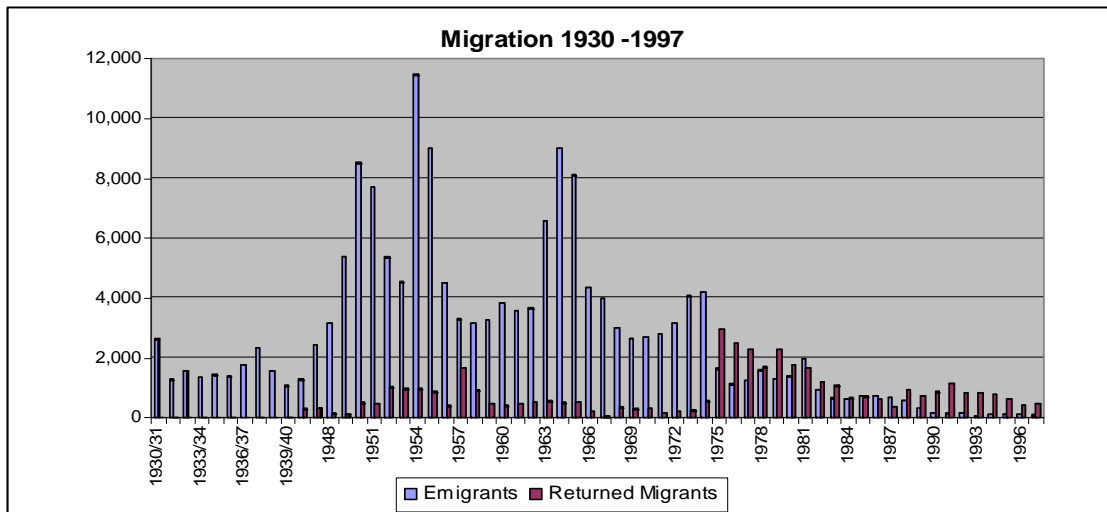
### Migration

One other factor that has played a major role in the Maltese demographic structure is migration. Small states' economies are fragile and liable to suffer very evident population movements that reflect economic downturns. Malta has not been spared this phenomenon and was witness to emigration during the early years of the last century and mass emigration during the 1950s and 1960s (Figure 5.5).

Migration in Malta stabilised in the mid-90s with a positive migration balance of fewer than 1000 persons per year. A number of emigrants returned over the years as the economic and political situations improved or they returned to retire. This is evident mainly in the island of Gozo where a simple residence name search would elicit city names or slogans from the country that had hosted them (mainly Britain, the US<sup>52</sup>, Canada and Australia).

<sup>52</sup> The returned migrant's attachment to the country they returned from was highly evidenced during the September 11, 2001 crises when Nadur saw more than half its flagpoles at half-mast.

Figure 5.5: International Migration: 1930 – 1997



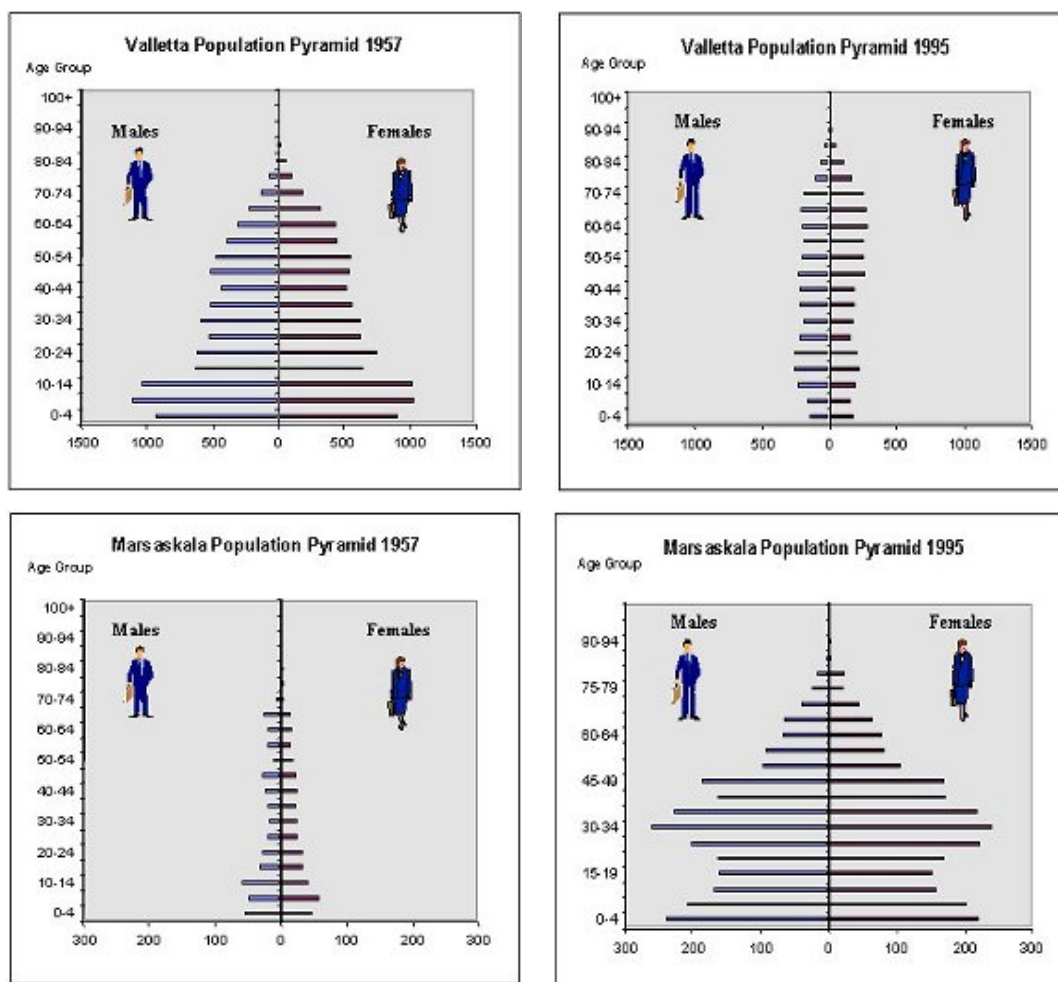
Sources: Labour Office, Central Office of Statistics, (MEPA Demographic Topic Paper, 2001: pg 15)

It is important to mention this phenomenon particularly in relation to crime. Migration may have had an indirect or not so indirect impact on crime due to reduction during the period of the age structure of the persons emigrating who were mainly young males. Reduction in males may result in more crime due to lack of guardianship, cohesion and family structures, (Doyle, 2005) something as yet not investigated in Malta. Also, it may have contributed to crime in the host country but it is not the aim of this study to investigate this issue here. Such includes verbatim episodes of bootlegging in the USA’s Prohibition in the 30s to ‘*malafede*’ occupations and the porn business in Soho (London) with the kingpin originating from the island of Gozo.

### Internal Migration

A study at sub-national (district level) depicts all areas having registered growth except the Grand Harbour area that has seen a steady decline since the late 1940s. The population in that area decreased from 55,000 in the 1950s to 31,000 in 1995. This has resulted in a pattern of loss from the Grand Harbour area to quieter and less dense areas such as Attard, Mosta, and Marsascala. In effect, such a migration trend resulted in deterioration of the stock as well as the establishment of a low-income status household structure (Ellul, 2003). Figure 5.6 depicts the changes in Valletta and Marsascala from 1957 and 1995.

Figure 5.6: Population Changes: 1957 & 1995 (Valletta and Marsascala)



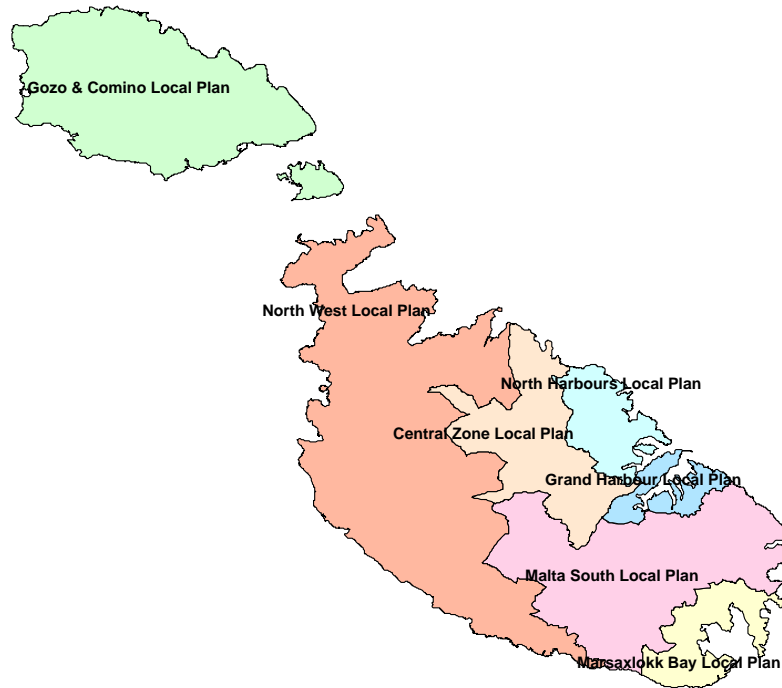
Source: Formosa S., (2000)

A study carried out by the author in 1996 based on water metering statistics<sup>53</sup> (as a surrogate for dwelling usage) identified out-migration as one component that still plagues the Grand Harbour Area. People prefer to move out of this area and into neighbouring areas. Internal migration occurs based on three preferential steps: the first choice would naturally be to reside in the same locality, then to an adjacent locality within the same local plan<sup>54</sup> (planning region – Figure 5.7) and finally to other areas. Though Malta is very small, the social construct tries to sustain itself through family ties, a very strong parochial presence and uniqueness of each town's culture (Boissevain, 1980).

<sup>53</sup> Water Services Data, (1995, 1996, 1998 data). Metering data used for the analysis of population structure by street, migration, dwelling stock and dwelling usage, Water Services Corporation, Malta. Study was carried out in 1996 by Saviour Formosa at the Planning Authority for analysis of population and dwelling statistics at mid-Census term.

<sup>54</sup> The Maltese Islands have seven planning regions designated Local Plans: Central Malta LPA, Gozo & Comino LPA, Grand Harbour LPA, Marsaxlokk Bay LPA, North Harbours LPA, North West LPA, and South Malta LPA.

Figure 5.7: Local Plan Areas (Planning Regions)



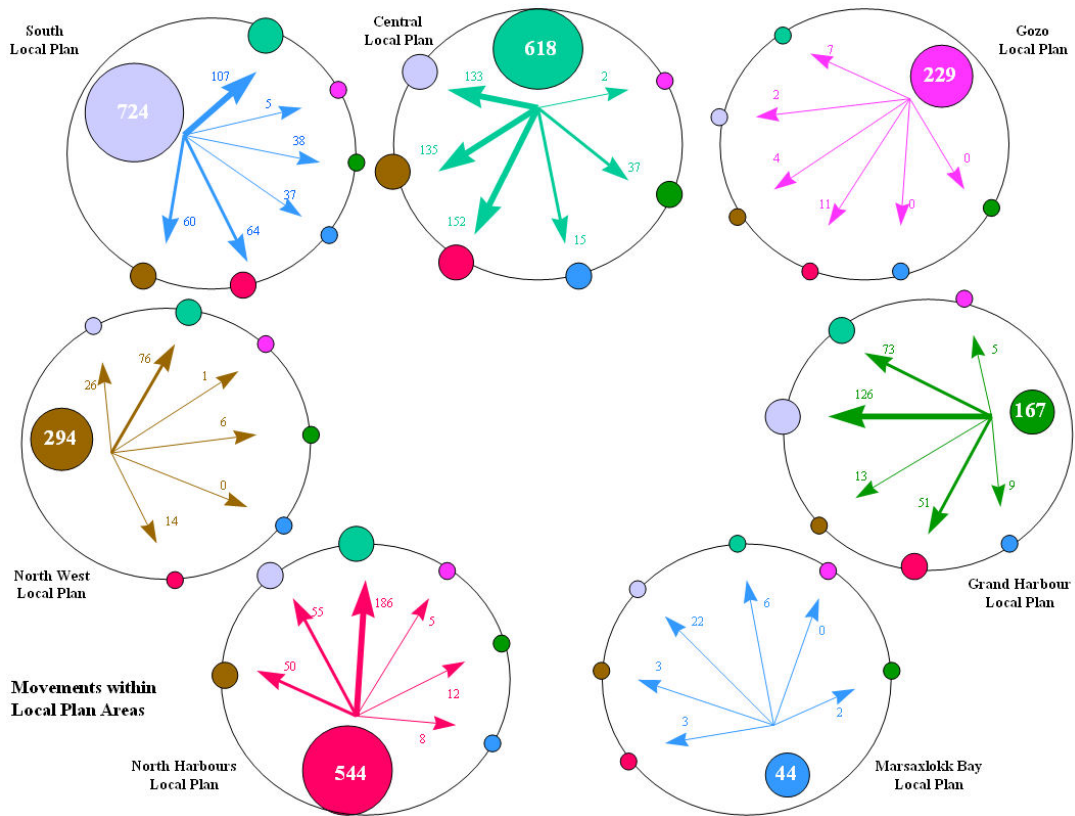
Note: Colours indicate the different Local Plan Areas

Source: The Author

Figure 5.8 indicates the movements that occur from one region to another both as out-movements and in-movements. Figure 5.9 depicts in detail the movements to and from the Grand Harbour Local Plan Area. Figures shown on arrows pointing away from the green circle indicate number of persons migrating out in 1996 whilst the figures for incoming arrows indicate persons moving into the local plan area. Whilst 167 persons changed residences within the local plan area, others moved out such as 126 persons who migrated to the adjacent South Malta Local Plan Area as against an incoming 38 from that area.



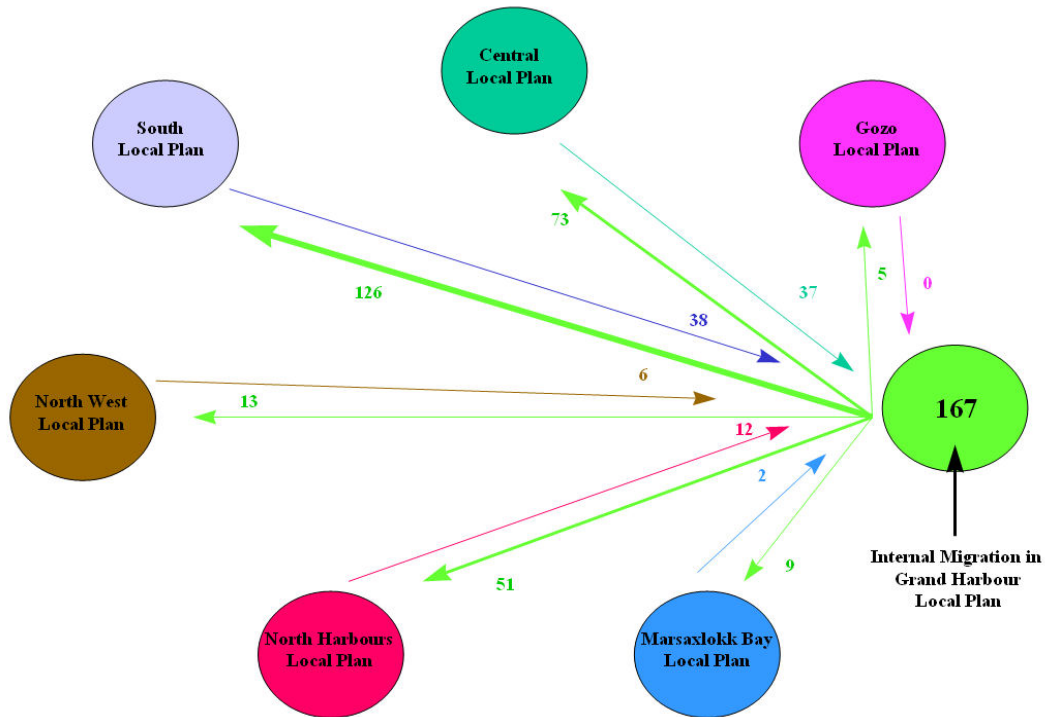
Figure 5.8: Internal Migration: 1996 – Inter-Local Plan Migration



Source: Formosa, 1996 – Study carried out at MEPA from Water Services Corporation Data.

Note: The figures indicate the number of persons who migrated from one Local Plan Area (LPA) to another (depicted by the large circles). Each LPA is designated a colour, for example North Harbours is given a red colour. The large circle within the North Harbours has a 544 figure embedded in the small circle, which figure indicates the number of persons migrating within that LPA. The arrows (number tagged) then depict migration to other LPA, each again designated by different colours. The arrow points to a circle sized according to the number of persons who migrated, example 12 moved to the Grand Harbour, depicted in dark green as against 51 who moved from the Grand Harbour to the North harbour Local Plan.

Figure 5.9: Internal Migration: 1996 – Grand Harbour Local Plan Area Movements

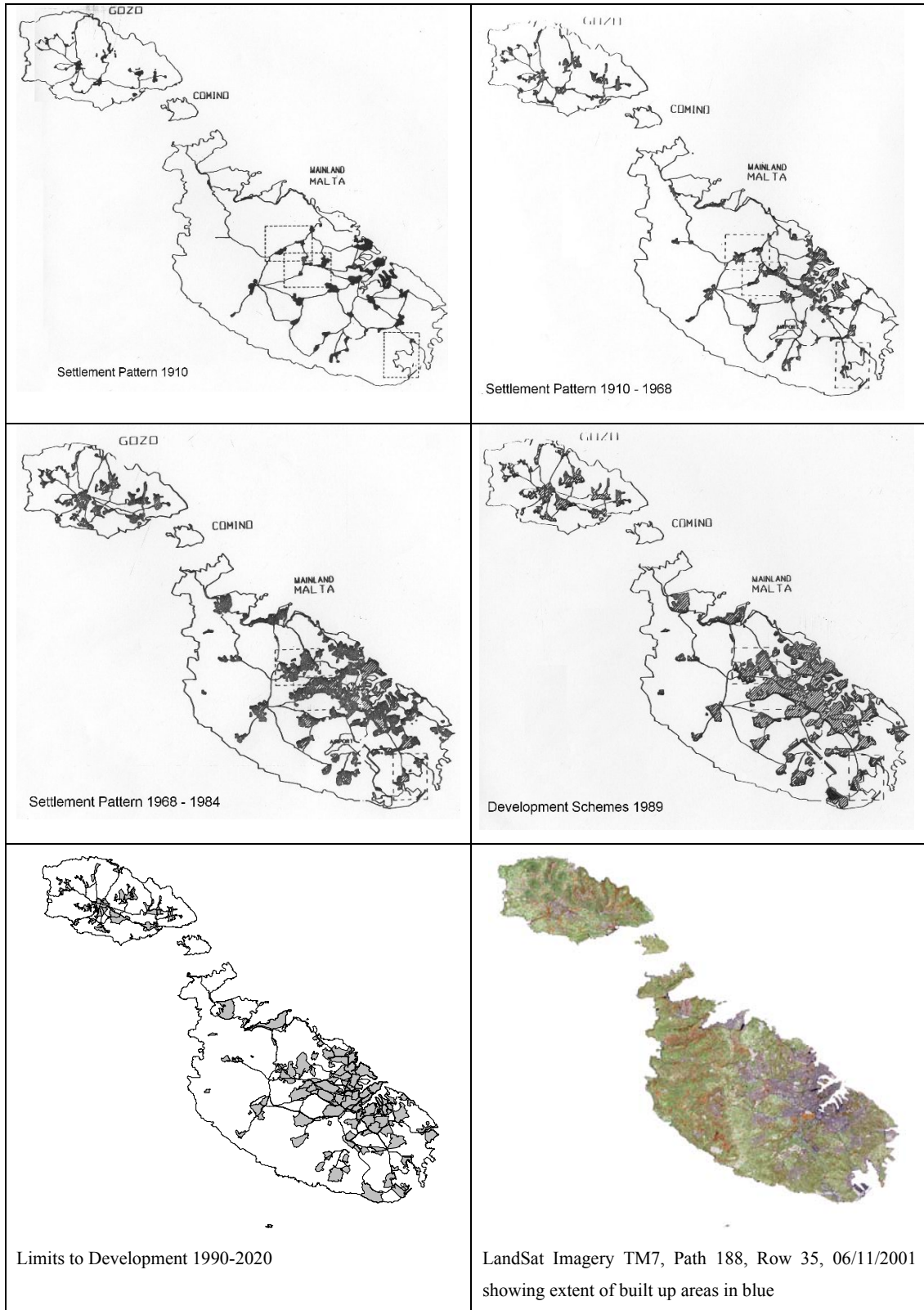


Source: Formosa, 1996 – Study carried out at MEPA. Data extracted from Water Services Corporation Data, 1996

### 5.1.2 Settlement Patterns and Housing

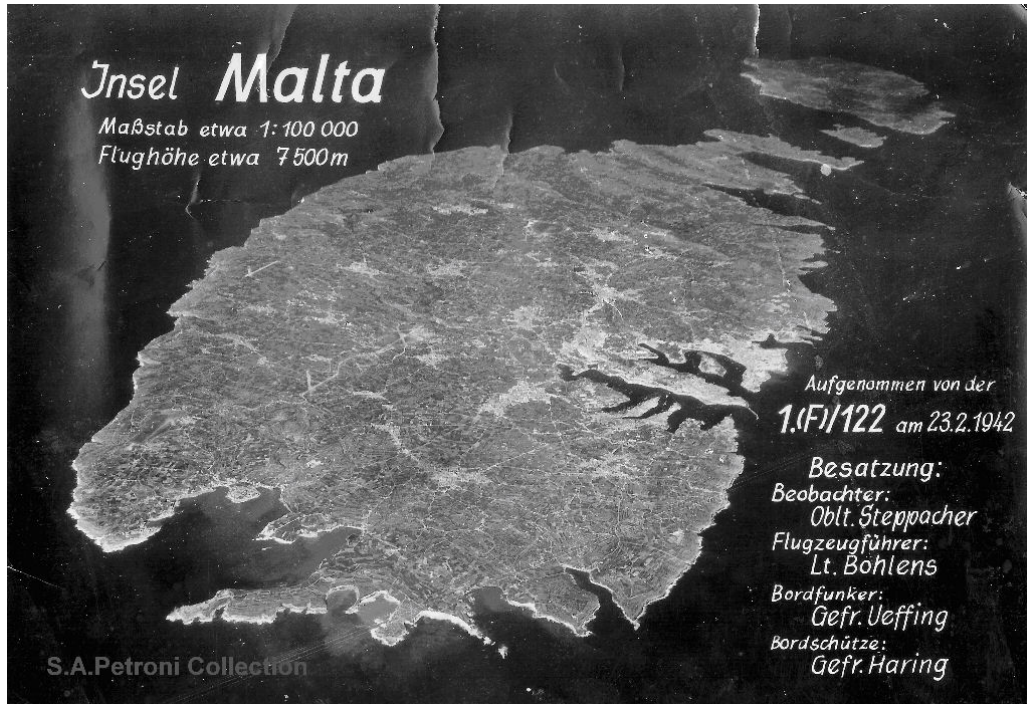
The Maltese Islands have been party to evident sprawl with small changes before the 20<sup>th</sup> Century to very rapid changes in the last 50 years (Figure 5.10). Prior to the 20<sup>th</sup> Century settlement patterns consisted of a number of rural villages with adjoining hamlets and a number of walled cities. As life became centred around a growing maritime enterprise in the Grand Harbour, the three cities of Bormla, Isla and Birgu saw rapid gains in population. This was due to transportation limitations and availability of living quarters close to work. However, changes started occurring, just before World War II and subsequently after the cessation of hostilities, which changes altered the face of urban Malta. Figure 5.11 depicts the major urban sprawl experienced from 1942 to 2005 as taken by a Luftwaffe pilot MEPA respectively.

Figure 5.10: Urban Growth 1910 to 1995

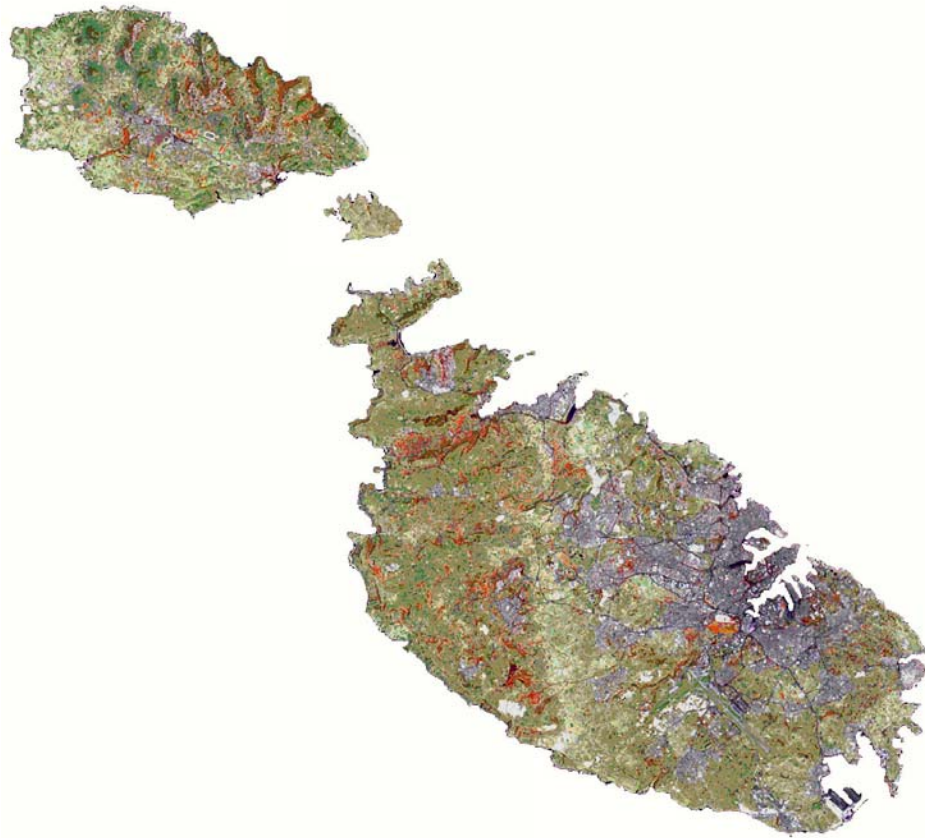


Source: Structure Plan Report of Survey Vol. 1 (August 1990), LimDev GIS Layer – MEPA, LandSat 2001 Imagery

Figure 5.11: Urban Growth 1942 and 2001



Source: S.A. Petroni Collection



Sources: MEPA (LandSat Imagery TM7, Path 188, Row 35, 06/11/2001)

Rapid growth occurred in settlements around Valletta, such as Sliema, Hamrun and Paola and later with the development of new towns such as Fgura and Santa Lucija; other changes were brought about when large tracts within the old towns and villages were developed. This occurred through free distribution of land through Home Ownership Schemes that resulted in an urban area that covers 23% of the total area of the Maltese Islands with a conurbation and its suburbs stretching from Zabbar to Naxxar (Figure 5.12) and still growing within the limits to development (the benchmark being the 1988 Temporary Provision Schemes)<sup>55</sup>. This rapid growth can be seen from a stock analysis as per Census 1995 figures that indicate that 31% of all dwellings were built before 1946, 23% were built between 1946 and 1970, and the remaining 46% between 1971 and 1995.

This change may have helped create a situation of anomie where new towns or rapidly growing villages such as Pembroke, Santa Lucija, San Pawl il-Bahar and Mtarfa experienced rapid influx of new persons. These persons did not integrate either due to their feeling isolated in the new residential area or also due to the number of new persons being larger than the previous residents, whereupon there was no natural integration of the locality's values and traditions. These 'soulless' towns suffer from a lack of belonging and may have been going through a process of stigmatisation and labelling such as Santa Lucija's 'Neighbourhood I'. The latter has gained a reputation of lawlessness, crime, drugs and unemployment. No academic studies exist to test this claim, though experience by the author at the Education Welfare Services Unit, has shown that there is consistent offending across the generations. More study is needed in this area.

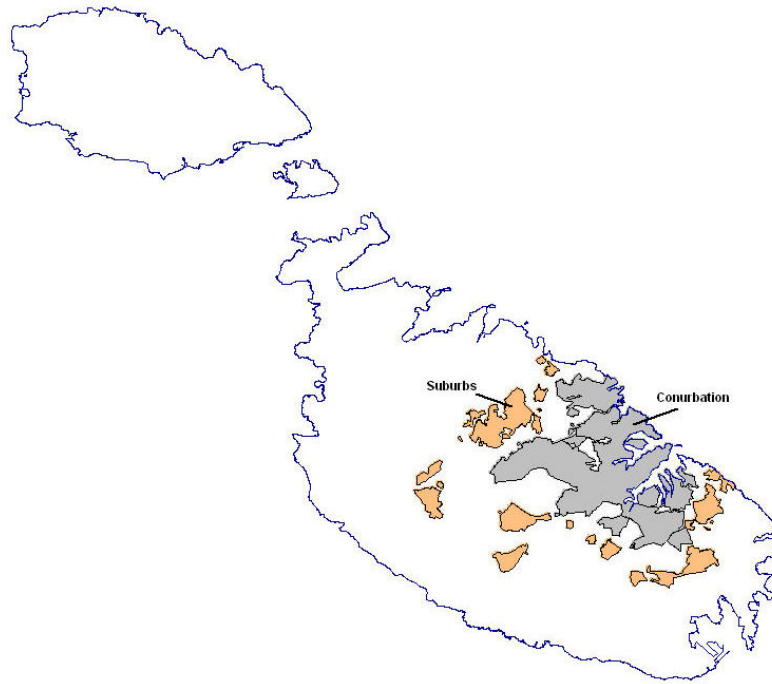
On the other side of the issue, old towns such as Valletta, Floriana and the three Cities (Bormla, Birgu and Isla) have had a constant drain on their human resources and are struggling to contain the town's soul, particularly with residences being replaced by retail and office units. This study investigates whether there is a relationship between crime and these categories of towns, particularly offenders' residential preferences.

---

<sup>55</sup> Such a change has rendered the issue of urbanisation in Malta as an academic issue, since Malta is essentially all urban or peri-urban. However, in line with the planning structure plan process, for the purpose of this study the areas designated as being situated outside of the Development Zone (ODZ) are analysed separately for crime activities.



Figure 5.12: Conurbation and Suburbs

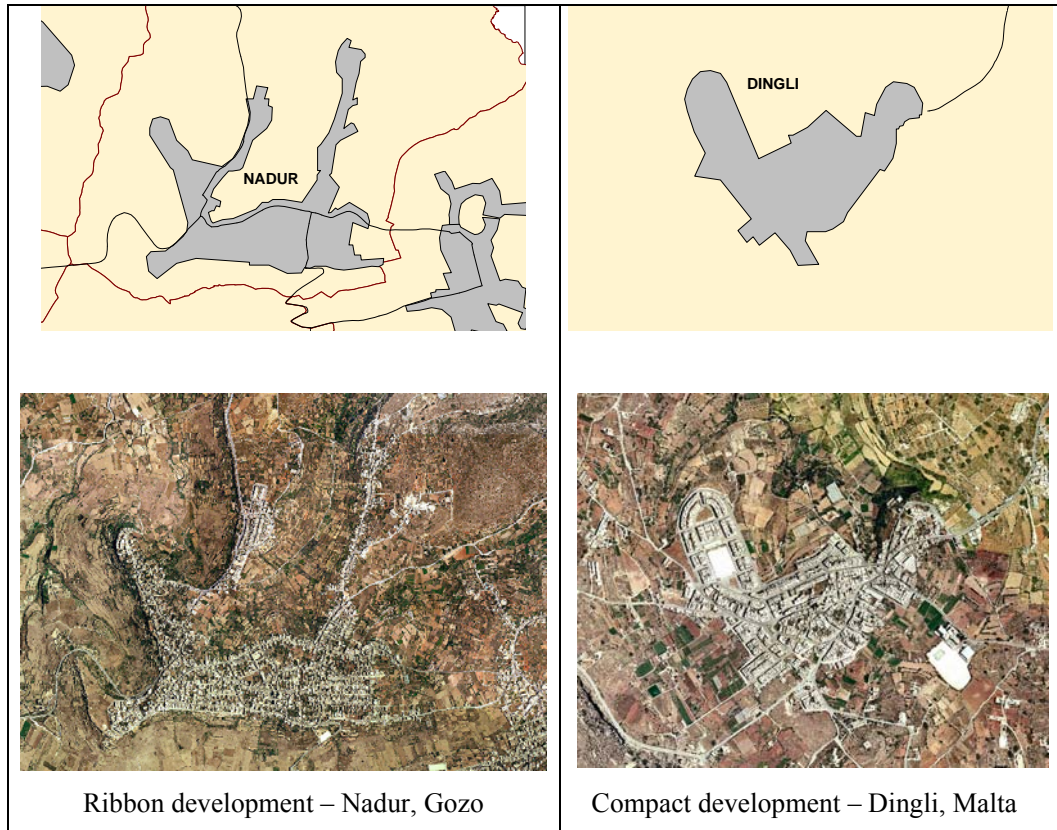


Source: The Author

In contrast, Gozo maintained most of its 'soul' since it has geographically distinct settlements that retain the traditional rural quality, with a large part of the population living in urban Rabat. This distinctness may be due to a variety of reasons, amongst them; a strong parochial presence, the insularity of each village and the topography that restricts horizontal development. In effect, Gozo has seen a lot of ribbon development on non-extendable ridges rather than the compact development seen in Malta (Figure 5.13).

Another issue related to Housing Estates and Home Ownership Schemes (HOS) settlement pattern is the fact that the commercial sector followed residential expansion and opportunities for crime increased in the new areas. Also, the economic structure of some towns changed to one that was more retail-based such as Birkirkara, Mosta, Rabat and Zabbar. Their town centres have been categorised into primary, secondary and tertiary centres based on their composition and services (Retail Topic Paper, 2001).

Figure 5.13: Ribbon Development in Gozo and Compact in Malta



Source: MEPA - Aerial Imagery, May 2004

This type of development does not follow such growth as that posited in the concentric zone theory. In Malta, one still finds the concept of industrial areas being zoned exclusively for that type of activity rather than in a mixed zoning type, however these are not situated in a concentric ring zoning but on the peripheries of town or villages. Malta is so small that travel is 'quick' and of short duration, thus migration was dictated by the availability of free land and development subsidy practices during the 80s and 90s rather than proximity. This is different to the 1900-1970s travel-laden scenarios where the drydocks concentrated most residents around the harbours, which towns are now rust-belt communities.

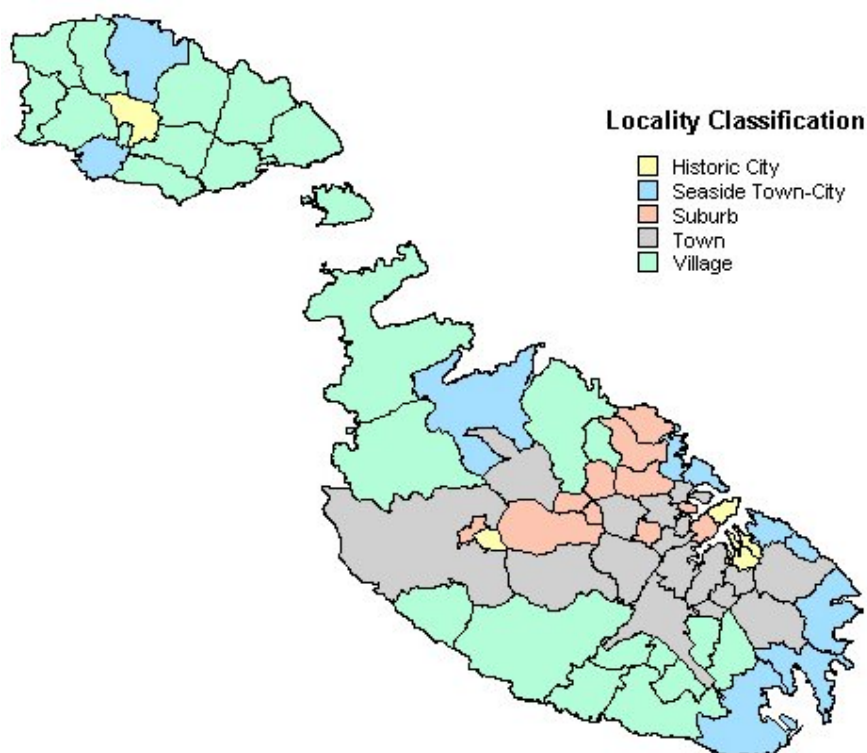
Whilst it is difficult to distinguish between the different types of settlements in the Maltese Islands, there are five distinct groups (Housing Topic Paper, 2002), mainly suburbs, villages, historic cities, seaside towns/cities and towns (Table 5.1 and Figure 5.14). This categorisation is used in the offender and offence analytical chapters.

Table 5.1: Localities classified by Settlement Type

Settlement	Local Councils
Suburbs	Pembroke, Lija, Mtarfa, Swieqi, Iklin, Attard, Floriana, St.Venera, Ta' Xbiex, Balzan, San Gwann
Villages	Mellieha, Naxxar, Xaghra, Nadur, Kercem, Xewkija, Qala, Ghasri, Ghajnsielem, Gharb, Sannat, San Lawrenz, Qrendi, Safi, Zurrieq, Mgarr, Mqabba, Siggiewi, Kirkop, Ghaxaq, Fontana, Gudja, Gharghur, Dingli
Historic Cities	Mdina, Victoria, Bormla, Valletta, Isla, Birgu
Seaside towns and cities	San Giljan, Marsascala, Munxar (including Xlendi), Xghajra, Marsaxlokk, Kalkara, San Pawl il-Bahar, Zebbug (Gozo) (including Marsalforn), Birzebbugia, Sliema
Towns	Zebbug (Malta), Zejtun, Luqa, Qormi, Mosta, Marsa, Tarxien, Zabbar, Msida, Pieta, Gzira, Birkirkara, Santa Lucia, Paola, Hamrun, Fgura, Rabat

Source: Modified from MEPA, Census 1995

Figure 5.14: Localities classified By Type



Source: The Author



## Vacant Properties

Malta's recent landuse development history has resulted in a situation with 23% of all dwellings (35,723 units as at 1995) being vacant, either through out-migration (depopulation), new build or dilapidation. Of these, however, approximately 13,000 units are used as summer residences, which dwellings are vacant for around 9 months in the year. The units that are vacant through abandonment or disuse are spread all over the islands though the Grand Harbour area caters for the larger part (MEPA Housing Topic Paper, 2002: pg. 44).

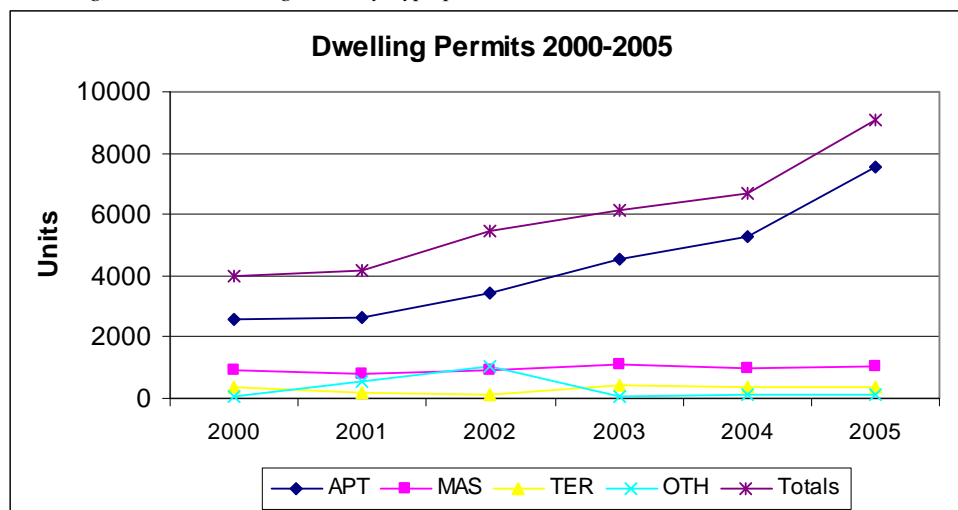
Dwelling permits to develop new build have accelerated from 3,970 units in 2000 to over 9,081 units being permitted in 2005 as against a need of 1,800 per year (Table 5.2 and Figure 5.15). Apartments make up the greater bulk of the units with ever decreasing instances of terraced units. This change signifies a changing structure of Maltese towns and needs to be analysed as against crime and population and dwelling densities.

Table 5.2: Dwelling Units by Type permitted 2000-2005

Approved Units by Development Type						
	2000	2001	2002	2003	2004	2005
<b>Apartments</b>	2552	2657	3420	4548	5265	7539
<b>Maisonettes</b>	949	774	910	1085	966	1058
<b>Terraced</b>	384	203	135	414	353	363
<b>Others</b>	85	546	1016	81	123	121
<b>Totals</b>	<b>3970</b>	<b>4180</b>	<b>5481</b>	<b>6128</b>	<b>6707</b>	<b>9081</b>

Source: MEPA Information Resources Unit, 2006

Figure 5.15: Dwelling Units by Type permitted 2000-2005



Source: MEPA Information Resources Unit, 2006

## **Public Open Spaces and Amenities**

Public open spaces in such densely built islands are few, though some areas have different provisions from others. Planned settlements such as Floriana and Pembroke have sizable open spaces and gardens whilst other areas, such as the walled cities and particularly recently developed areas have very few open areas, virtually rendering the towns into one single building block.

## **5.2 Political, Religious, Educational, Family and Economic (PREFE) influences in the Maltese Islands**

This section covers the PREFE sectors as they influence the development of Maltese society.

### 5.2.1 Politics

#### **Political Rights**

The introduction of political, social and civil rights and the resultant reduction of social inequality in Malta can be said to have occurred in the last century. The 1921 constitution saw political rights being introduced for a section of the population voting for the Lower Senate. These were limited to male citizens aged over 21 years and only according to the capital they had (an income of £20 or over from property or paying for rent at the same amount). In the Higher Assembly (General Senate), only ecclesiastics of higher order as well as people with a University degree or worth £100 could vote. Inequality in this era stemmed from the prevailing economic situation that ultimately gave rise to social and political discrepancies.

Following periods of unrest (the 1933 and 1939 legislatures saw the suspension of the Constitution), the 1947 Constitution introduced more political rights i.e.: a single vote for each person (male and female) over twenty-one where the right of women to stand for election was also given. This constitution saw the eradication of disqualification based on old age, education, sex and property.

#### **Civil Rights**

The 1921 and 1947 constitutions mainly emphasised the upgrading of political rights. Whilst the 1947 Constitution provided the legislation for the introduction of Social Services in Malta, civil rights appear to have been introduced over a number of years: from 1964, through to present

years<sup>56</sup> where recent changes have focused on the alignment of the relevant laws to EU legislation. The 1987 Human Rights Act incorporated the European Convention of Fundamental Human Rights.

The 1964 Constitution introduced basic rights including freedom of conscience and expression; freedom from religious discrimination, protection of freedom of movement, privacy of home and property; primary education, and protection from extradition from Malta for a political offence save in accordance with the Fugitive Offenders Act of 1881. The rights to opinion, citizenship, right to edit or/and print newspapers were also included.

### **Social Rights**

The Maltese citizenship rights, which at first instance were basically political, saw the conception of the social laws at around the same time as the growth of the civil laws. Due to colonisation, it can be said that the Maltese social law took a long time to be accepted. 1947 is quite late for such passing of the Social Services Act. This does not imply that there were no previous laws, but those early laws did little to cultivate the welfare state.

In 1929, the Workers Compensation Act gave the right for Injury Benefits and was amended six years later. These were improved mainly in 1948, with the Old Age Pensions Act, the welfare state introduction in 1956, the 1965 Act with its invalidity help as well as a series of measures introduced over the recent decades including children's benefits, free hospitals, compulsory free education, etc. Though sometimes controversial in the method of introduction, few rights have been withdrawn even as affluence increased.

Marshall (1949) traced the development of rights in Britain as progressing from civil to political and finally to social. Maltese development on the other hand, passed from political to civil, to social (although sometimes the latter two seem to have developed concurrently). Also, political rights in Britain, which were initially restricted to the upper classes, later included the middle classes, then the working classes and eventually women. Malta, being a British colony, can be said to have been influenced by such a progression of rights.

In the 1950s the economic situation was in dire straits with the retrenchment of the British forces, as well as due to the post-war recession apart from the devaluation of the sterling in 1950, (Koster, 1984: 140). However, the Government still managed to improve housing facilities, reconstruct homes, clear slums, stimulate mass emigration, raise public health standards,

---

<sup>56</sup> Laws of Malta, Human Rights Country Reports - [http://us.politinfo.com/Information/Human\\_Rights/country\\_report\\_170.html](http://us.politinfo.com/Information/Human_Rights/country_report_170.html)

promote agriculture and fisheries as well as introduce full-time compulsory education and an adult education campaign against illiteracy.

In 1953, during an election campaign, the Nationalist programme outlined social legislation as a means of alleviating poverty. Also, following this election, the government fell in 1954 and as the old splinter group from the Malta Labour Party (Malta Workers Party - MWP) committed political suicide by crossing the floor, the General Workers Union (GWU) which was pro MWP could now work towards integration with the MLP. This political move created a decades-long controversial scenario where decisions by government were endorsed by the GWU until the late 1980s.

### **Ethnicity**

In Malta there are negligible race differences or different ethnic groups except that based on a religious denomination<sup>57</sup> other than the Roman Catholic belief. Following a reduction of foreigners after independence in 1964, due to British rundown<sup>58</sup>, the number of foreigners living in Malta is once again increasing, especially those from the North African countries and eventually a mixed race/religion and ethnic culture may well result. Foreigners moved in for seasonal or long-term stays with a resultant mix of cultures and even crime. Long-term stays became rooted communities such as the growth of an Arabic community in Mosta in the nineties that moved to San Pawl il-Bahar during the early 2000s. Analysing crime by ethnicity may help identify impacts as evidenced during the 1990s of foreigners committing homicide on other foreigners as against targeting Maltese victims.

A recent phenomenon where Malta has not gone untouched and which is also impacting on crime is that of illegal migration. Large annual numbers of migrants, that at times may reach above natural (population) growth balance have arrived in Malta from Libya on boats. Whilst most are non violent, incidences have been registered where individuals in free centres partake in crime such as drugs (Khat case in July 2006<sup>59</sup>), alleged group rapes (2006<sup>60</sup>) and other offences. Such incidences cause a misconception of this group, enabling xenophobic debates that generally hinder the investigation process.

---

<sup>57</sup> The Moslem component is growing to a significant number so much so that they were requesting and were eventually awarded a separate burial ground as the current Turkish-administered cemetery is small.

<sup>58</sup> The reduction was also evidenced in a parallel reduction in the number of prisoners of British origin during the colonial period.

<sup>59</sup> Calleja C, (Thursday 28<sup>th</sup> September 2006), Khat plant contains scheduled drugs – expert, Times of Malta, - <http://www.timesofmalta.com/core/article.php?id=238299&hilite=khat>

<sup>60</sup> The Malta Independent (5 May 2006), Sexual Assault in Paceville, - <http://www.independent.com.mt/news.asp?newsitemid=32714>

## 5.2.2 Religion

Religion plays a major role in Maltese society, though this is slowly changing; following a considerable period of Church domination that to a certain extent imposed a confessionalist state. Such a situation has impounded on the very fibre of Maltese culture that is centred on the church and its festas, where society was dependent on the priest for advice and shepherding. It can be stated that the old village life was essentially led by the village priest, the notary and the local policeman. Malta's transition from a confessionalist state in the 1960s to a secular one is changing rapidly such that the church is losing membership either through disinterest or through the infiltration of other religions/denominations/sects. The impact of the religious aspect on Maltese culture was such that laws on blasphemy were highly enforced in the confessionalist period, which laws are ignored in today's secular society, even though they still make up part of the legislation, with only one blasphemy-related incarceration case registered in the 1990s, as elicited from this study's data.

### **State-Church Relations**

The Church had a major say in politics and particularly during the late 1940s was consulted by the Prime Minister Boffa on important legislative proposals to the extent that when in 1948 an Income Tax Bill was on the Table of the House, the then Archbishop Gonzi protested. As a result of this the surtax was reduced and the personal income of the Archbishop was classified as tax free. Mintoff (Lehen is-Sewwa, 1961, Pg 4) wrote that the exemption was given by the State as it was "simply following its duty as a Catholic Government", (Koster, 1984)). The power of the Church was absolute so much so that the Archbishop Gonzi stressed that he demanded absolute loyalty from the clergy and that he usually managed to have the right priest in the right place as well as the fact that the Governor of the time Sir Gerald Creasey, was asked by London to try to please the Bishop and clergy (Koster, 1984: 147).

The Church's stronghold was education, having a monopoly over private schools at primary and secondary levels. It controlled local cinemas, controlled entertainment through Village festas that were centred around the parish church and were the main social event of the year. It also encouraged secondary feasts though this brought about unprecedented rivalry. The church also had religious programmes on cable radio and lately its own radio station. The Church is very conservative with a strong say over censorship, the latter now diminishing as well as through rapid secularisation. Sex education was introduced in the 1970s though it is still preaching traditional/natural methods of contraception.

The church had been nurtured by the British Colonial Administration as part of a special protection to maintain its (Church's) power and authority that ultimately generated an increasing rise of anticlericalism first among the middle class and later spread to the working class. This situation was particularly graphic in the 1930s and 1960 which even saw the imposition of interdicts on non-conformers (Malta Today, 2005). The so-called 'politico-religious' wars in the 30s and 60s created major cracks in the power maintained by a once monolithic and medieval Church<sup>61</sup> (Koster, 1984).

Mintoff (Malta Labour Party leader 1940 to 1984<sup>62</sup>) and the entire executive were interdicted on 8th April 1961 for failing to make public reparation for grave offences committed by the MLP (causing scandal) against the Ecclesiastical authorities of the islands of Malta and Gozo. Koster maintains that in effect this caused social ostracisation since 'the interdict is a serious canonical sanction which bars those punished from receiving the Sacraments, they cannot marry in Church, cannot have their children baptised or act as godparents nor receive Catholic burial. In a fully Catholic country like Malta the interdict weighed heavily on the offender' (Koster, 1984: 289).

Koster maintains that since the power of the Church was also sustained by the British rule, once Malta gained independence this power started its decline. However, one has to keep in mind that a progressive party came to power soon after, the impact of the media flourished from that period, education levels soared as well as other socio-economic and socio-cultural settings may have helped the decline. For the first time since the Knights of St, John ruled the islands; the Church was back to a position where its absolute rule over the government was taken away.

### 5.2.3 Education

Education is compulsory for all children living on the islands and aged between 5 and 16 years. Malta also provides post-secondary and tertiary education, third-age education and a whole range of continuing education services. Even with such a high rate of attendance, illiteracy was still high at around 12% in 1995 from 33% in 1948 and 12% in 1985. The highest rate of illiteracy is found amongst the unemployed with 19% being illiterate. Offenders' literacy levels are investigated as against the relative national data to help elicit the social situation of this particular group.

---

<sup>61</sup> The Church had the highest ratio of clergyman to layman in the world - In 1966 = 591 diocesan and 455 regular priests. In addition there were 1718 brothers and nuns (164 belonging to contemplative orders and thus had no 'combat-value' (Koster, 1984)).

<sup>62</sup> [http://www.doi.gov.mt/EN/islands/prime\\_ministers/mintoff\\_dom.asp](http://www.doi.gov.mt/EN/islands/prime_ministers/mintoff_dom.asp)

The Maltese Islands have 290 schools and 270 libraries categorised by Government, Independent, Private and Church administrations. They cater for around 75,000 primary and secondary-level children and around 14,000 in post secondary and tertiary education. Also, around 100 child-care and kindergarten centres are catering for this sector.

Child-care centres, kindergarten and primary schools are normally found within the locality of provenance of the particular school's students. However, private schools do not normally follow this trend and induce transport issues. These cater for children aged 1 to 10 years. Secondary schools that cater for children aged 11 to 16 years follow a different location regime, with students in state secondary schools and Junior Lyceums, are located according to the area of residence, oftentimes with long commuting times imposed. Private schools also follow this pattern.

As regards post-secondary and tertiary education, the former is catered for by both private and government entities, whilst there is only one University on the islands and caters for both local and international students.

As schools offer ready-made targets for offenders due to the susceptibility of youngsters to fall victim of erstwhile predators, laws have been enacted that award more severe sentences for persons found offending within 100m of a school. It can conversely facilitate crime by students in their home-to-school journey as opportunities make themselves available. A review of this distance impact is carried out in this study.

Children of school age can be brought before the Juvenile Court in case of offending (Refer to Section 5.3.1). Another deterrent that has been employed in Malta concerns children who abscond from school (particularly for working reasons or simply to roam the streets).

*“One hundred and sixteen children never attended school between October 1998 and February 1999. An ongoing Maltese study by renowned School Non-Attendance Phenomenon expert N. Ishikawa, rates the level of children in Malta who miss school because of "family problems" at 11.8 per cent of all absentees, which is double those who do not have family problems”* (The Malta Independent on Sunday, 9<sup>th</sup> April 2000).

The parents of these children are taken to court through the Educational Welfare Unit. However, one doubts the effectiveness of the Educational Court as the fines awarded are so ridiculously

low that in effect they could be encouraging more students to follow this path. A maximum fine of Lm10 per month is a pittance against a minimum of Lm150<sup>63</sup> that a young person may get illegally through work. Fines should at least be equivalent to a minimum wage to deter parents from turning a blind eye to the situation or even encouraging their children to go to work. A pity too that private schools and “elite” public schools such as the Junior Lyceums rarely report children to the Welfare Unit, in effect hiding the level of offences.

#### 5.2.4 Family: Social & Community

### Health

Malta enjoys a high level of health with an extensive array of hospital and clinic services both in the public and private domains, with 5 state Hospitals, and a new one at Tal-Qroqq Msida being built. One of these hospitals caters for the island of Gozo.

*Table 5.3: Government Health Centres Catchments*

<i>Locality of Health Centre</i>	<i>Catchment Localities</i>
Floriana	Valletta, Floriana, Hamrun, Sta. Venera, Marsa, Zurrieq, Safi, Luqa, Mqabba, Qrendi, Kirkop, Pieta
Gzira	Sliema, Gzira, Msida, St. Julians, San Gwann, St. Andrew’s, Ta’ Xbiex, Swieqi
Qormi	Qormi, Zebbug, Siggiewi
Paola	Paola, Tarxien, Sta. Lucia, Birzebbugia, Zejtun, M’Xlokk, Zabbar, Marsascala , Xghajra, Fgura, Ghaxaq, Hal Far
Bormla	Bormla, Birgu, Isla Kalkara
Mosta	Birkirkara, Lija, Balzan, Naxxar, Gharghur, San Pawl il-Bahar, Burmarrad, Mellieha, Mgarr, Bugibba, Qawra, Bahar ic-Caghaq, Madliena
Rabat	Rabat, Mdina, Dingli, Mtarfa, Attard
Birkirkara	Birkirkara, Iklin, Lija, Balzan
Gozo	All Gozo

Sources: Ministry of Health Data (2000), Central Office of Statistics, (1999)

Government also runs 8 main health centres and 41 secondary health centres (Table 5.3). Whilst the former are well equipped and cater for most eventualities, the Secondary health centres are typically in a bad state of repair and suffer poor accessibility. Use of free public clinics can be a gauge of how much deprivation affects these services, though data is not available at this level.

<sup>63</sup> Calculated at Lm5 daily (or GBP7.5).



Private health care consists of 3 hospitals and 11 clinics. The demand came about due to increased affluence and long waiting times at state hospitals as well as provision of services not available in government services.

### **Substance Abuse**

Substance abuse is another issue that directly relates to health and has a direct link to crime. The number of persons seeking Sedqa<sup>64</sup> services through the Detox Outpatient Centre practically doubled from 505 in 1995<sup>65</sup> to 929 in 2002<sup>66</sup>. It is difficult to gauge how much crime is committed by drug abusers. The Corradino Correctional Facility (CCF – prison) has a unit called SATU (Substance Abuse Therapeutic Unit) that is part of the prison regime though in another part of the island in Mtaħleb, Rabat, where prisoners who were partaking to drugs willingly reside there; circa 6% of the total prison population on average follows on-going rehabilitation. One cannot gauge drug taking prior to and during imprisonment but research needs to be carried out in this area.

## 5.2.5 Economy

### **Employment**

Prior to independence in 1964, and even more so in the 1950s, Malta's economy depended on servicing the British military, naval and air establishment. This situation meant that the economy had excessive reliance on one source of income tied to the economy of one foreign country. During the 1950s, as much as 26% of the working population was employed with the British military sector, which situation changed in 1955 when the rundown was declared which shrank to 0% in 1979 when the last of the British military contingent left the islands on the warship "HMS London" (Sultana *et al*, 1994).

The Maltese labour scene evolved rapidly following independence and since then its structure and composition has changed considerably with increased locally-generated job opportunities. This followed the period of high emigration in the 1950s and 1960s to the effect that some emigrants returned back. This situation has been aided by changes in values and morals such as the inclusion of women in the labour force, a lower participation by youths due to extended learning as tertiary education took off from a mere 700 students in the 70s and 80s to circa 9,800

---

<sup>64</sup> Sedqa was mandated by a Cabinet decision to provide Prevention and Care Services in its bid to increase awareness and treat drug and alcohol abuse - <http://www.sedqa.org.mt/>

<sup>65</sup> [http://www.geocities.com/socfam\\_malta/sedqa96.htm](http://www.geocities.com/socfam_malta/sedqa96.htm)

<sup>66</sup> [http://www.sedqa.gov.mt/pdf/information/reports\\_malta\\_sedqaannualreport20012002.pdf](http://www.sedqa.gov.mt/pdf/information/reports_malta_sedqaannualreport20012002.pdf)

in 2005<sup>67</sup>. Other advances that have helped the economy during the last two decades include; the introduction of a liberal trade regime, liberalisation of the financial sector and the carrying out of a number of substantial infrastructural projects such as the Freeport, airport, and seaport restructuring.

A short description of the situation in the 1990s shows that whilst labour supply increased by 8.9% between 1991 and 1999, participation rate is also estimated to have risen by 0.7 percentage points to 61.2% in 1999. However, female participation rate, at around 40%, is still very low compared to the 60% figure in developed nations. Table 5.4 shows that the main trends in employment is due to market services, having nearly half the pool, with direct employment in 2000 at 29% and the public sector still high at 23%. Tourism makes up a high percentage of income of currencies to the Maltese Islands and employs a large share of the supply pool. Tourism also causes major fluctuations in the population structure, especially in summer, and in turn creates varied crime opportunities.

*Table 5.4: Employment Trends*

Year	Gainfully Occupied		Direct Production		Market Services		Government		Temporary Employment	
	Employed	% of gainfully employed	Employed	% of gainfully employed	Employed	% of gainfully employed	Employed	% of gainfully employed	Employed	% of gainfully employed
1991	125,649	35	44,247	39	48,535	23	28,318	23	4,549	4
1995	132,800	32	42,313	40	53,663	24	32,271	24	4,583	3
2000	140,415	29	40,832	45	62,665	23	32,326	23	4,592	3
2005 (Sep)	137,813	24	32,788	43	59,134	33	45,061	33	830	1

Source: MEPA, 2001, Economic Survey: January-September 2005

Regarding child labour, as at 2000, there were around 10,000 teenagers between 15-19 years who were economically active<sup>68</sup>. This is due to the fact that youths start working at age 16. Though informally, underage children are employed during summer months, as domestics, kitchen helpers in restaurants, or as vendors, there is a formal though rare approval for full-time work that seeks the approval of the Minister of Education (Laws of Malta - Chapter 327). In fact in, 1995, this resulted in 0.04% of children between the ages of 10-14, were economically active<sup>69</sup>.

<sup>67</sup> <http://www.um.edu.mt/noticeboard/univ.ppt>

<sup>68</sup> ILO, Yearbook of Labour Statistics, 1999

<sup>69</sup> ILO, International Labour Office - Bureau of Statistics, Economically Active Population 1950-2010, STAT Working Paper, ILO 1997

## Unemployment

The main issue regarding employment in Malta concerns the case of hidden unemployment. This is accounted for by a comparatively large number of students (postponing the entry in job scenario), a large percentage of women not in the labour force and an overmanned public sector.

As compared to Malta's registered rate of 5.1 per cent in 1998, other European countries registered a higher rate of unemployment: 11.2 for Germany, 11.5 for France, 11.2 for Italy, 19.1 for Spain and 6.6 for the United Kingdom<sup>70</sup>.

Unemployment decreased in Malta from 6% in 1991 to 5% in 2005 as shown in Table 5.5, though a detailed analysis shows that unemployment is mainly concentrated in the Manual category which makes up 60.5%, with 34.3% being Non-Manual and 5.2% Disabled Persons (Table 5.6). An Unemployment Register is kept in Malta that records changes in these categories<sup>71</sup>. Also, males accounted for 69.3 per cent of the manual unemployed category and for 25.7 per cent of the non-manual unemployed.

*Table 5.5: Unemployment Trends*

<i>Year</i>	<i>Unemployment</i>	<i>Unemployment Rate</i>
1991	8,041	6.0%
1995	7,213	5.3%
2000	6,432	4.7%
2005 (Sep)	7210	5.0%

*Source: Economic Survey, 2001, 2005*

A further analysis of unemployment concerns age group structure. Table 5.7 indicates that the age group most concerned with unemployment is the 25-49 year-old group. The 16-24 year group shows a decrease which could be attributed to a variety of factors, amongst which is an increased student population. Also, the 49 plus age group saw increases over the years.

Table 5.7 shows the age structure for those registering for work. The percentage of unemployed youths, defined as those falling within the 16-24 years bracket has fluctuated over the period within the 28.6 to 30.6 band with a low in 2000. There has been a consistent decrease over the period in the 25-49 age-group with a consistent increase over the last six years in the percentage of unemployed persons over 49 years. These categories are analysed in detail in relationship to

<sup>70</sup> The Malta Business Weekly, 4-10 February 1999, Maltese unemployment rises as EU average declines, Issue No. 224, Malta

<sup>71</sup> Part I of the Unemployment Register, Employment and Training Corporation, Malta

the unemployment figures for incarcerated persons in order to gauge the relationship to the national levels.

*Table 5.6: Registered Unemployed Classified By Occupation*

	<i>Registered Unemployed</i>	<i>Percentage Distribution</i>
<b>Non Manual</b>		
Clerical and related workers	891	13.7
Supervisory	35	0.5
Technological and Professional	770	11.8
Miscellaneous non-manual	534	8.2
Total Non-Manual	2,230	34.3
<b>Manual</b>		
Agriculture	174	2.7
Construction	528	8.1
Textiles	14	0.2
Printing	22	0.3
Metal working	247	3.8
Catering	304	4.7
Other services	427	6.6
Labouring	444	6.8
Miscellaneous	1,777	27.3
Total Manual	3,937	60.5
<b>Disabled Persons</b>		
	341	5.2
Total	6,508	100

*Source: Economic Survey, 2005*

*Table 5.7: Registered Unemployed by Age Distribution*

<i>Year</i>	<i>Registered Unemployed</i>	<i>16-24 years per cent</i>	<i>25-49 years per cent</i>	<i>Over 49 years per cent</i>
1996	6,245	30.6	57.6	11.8
1997	7,149	30.3	57.0	12.7
1998	7,437	28.7	58.2	13.1
1999	7,695	28.6	57.0	14.4
2000	6,583	27.5	56.8	15.7
2001	6753	29.2	55.4	15.4
2005 (Sep)	6508	27.1	55.3	17.5

*Source: Economic Survey, 2001, 2005*

## Poverty and Deprivation

Whilst an index of deprivation has not been developed for the Maltese Islands, studies have been carried out on the presence of poverty. The studies were carried out at a national level and studies at regional and local council level have not yet been attempted. The main studies carried out in Malta were the 1994, 1996 and 1998 Caritas-Discern studies on poverty<sup>72</sup> and in 2002 the National Statistics Office (NSO) published a set of Structural, Poverty and Social Exclusion Indicators<sup>73</sup> as part of its drive “to provide a set of harmonised and easy-to-understand statistical indicators on various policy areas including employment, innovation, economic reform and social cohesion” (NSO, 2002: 2<sup>74</sup>).

Both reports take off from the premise that poverty as such does exist in both its traditional form that of material needs to that generated by affluence. In fact they consider poverty in affluent Malta in all its forms and reach a conclusion that no one indicator or variable is responsible for poverty but it is a multifaceted and interrelated issue. “Poverty has many faces and faces often tended to merge” (Discern, 1996, 39) and they include such notes as access issues, feelings of being left out both psychologically and physically (Discern, 1996: 16).

An interesting conclusion that was reached included their reference to crime where each variable indicated that at some point or other the termed poor had contacts with criminality.

*“Poverty was a threat to the national community. It was not merely a situation which oppressed citizens hit by one or more of its forms. A number of them were directly linked to crime. Most of the forms emerged from the germs of inequality present in society. All were injecting germs into it (Discern, 1996: 39).”*

The NSO document developed an at-risk-of-poverty rate<sup>75</sup> that indicated that in Malta (Figure 5.16), the rate was 14.9 per cent, as against 18 per cent across the EU. This varied across the EU

---

<sup>72</sup> The 1994 Caritas and Discern targeted the issue of poverty through a review of its existence from an official if grass roots level consisting of 80 parish priests. This initiative, termed Poverty Watch was rerun in 1996 and considered the opinions on poverty of agencies that are committed to helping the poor. These included 8 public, 31 private and 26 church agencies. Whilst the documents take on a religious viewpoint and tend to refer to religiosity more than once, considering its source, the 1996 report however takes the opinion of organisations in all spectra of public contact.

<sup>73</sup> NSO joined Eurostat’s Structural Indicators Programme and aimed to produce a set of local indicators that could be compared to those in either the EU member states or the accession countries.

<sup>74</sup> NSO, (2002), Structural, Poverty and Social Exclusion Indicators, Valletta, Malta.

<sup>75</sup> Percentage of persons whose National Equivalised Income (NEI) lies under the at-risk-of-poverty threshold as a percentage of the total population living in households – the data was accrued from the Household Budgetary Surveys of 1998 and 2000/1. The threshold is calculated at 60% of the Median Income.

accession/applicant countries of between 9 per cent in Hungary (1999) and 23 per cent in Turkey (1994). Most of the Maltese persons are found in the 0-15 year old group (21 per cent) against 24 per cent in the EU15 countries are at risk of poverty. Economic activity analysis indicates that the unemployed have the highest number of individuals who are at risk of poverty: 50.4 per cent in Malta, as compared to 38 per cent within the EU. This premise is used in the analysis section of this research where unemployment is used as a surrogate for poverty.

The risk-of-poverty rate indicates that over 57,000 persons in Malta (14.9%) earn less than Lm2,036 that is 60% of the median income of Lm3,394 (Table 5.8). This is reflected in the Census 1995 analysis, though it may need further analysis due to unreliable<sup>76</sup> declaration of income in that survey, as reflected in a cross-analysis of recorded income as against material goods ownership that does not reflect income figures.

*Table 5.8: Poverty Indicators*

<b>Threshold</b>	<b>Value (Lm)</b>	<b>Number of persons below threshold</b>	<b>% household population</b>
Median	3,394	192,750	50.0
40% of the median	1,357	11,770	3.1
50% of the median	1,697	29,780	7.7
<b>60% of the median</b>	<b>2,036</b>	<b>57,380</b>	<b>14.9</b>
70% of the median	2,376	88,420	22.9
20th percentile	2,261	77,126	20.0
80th percentile	5,092	308,504	80.0
S20	135,565,300	N.A.	N.A.
S80	607,001,200	N.A.	N.A.
S80/S20 ratio	4.5	N.A.	N.A.

**N.A.** not applicable

Source: NSO, (2002)

In the case of housing the main item that can be elicited from the Discern study, other than infrastructural issues, is the introduction of wider-than-mere-structural conclusions like the need to include the issue of “dilapidated and shabby neighbourhoods which rendered social interaction difficult. This actually sows the seed for social partners to look beyond poverty and more at deprivation” (DISCERN, 1996: 13). Such statements fall in line with the Wilson and Kelling’s Broken Windows theory (1982).

Poverty Watch describes a direct relationship between imprisonment and poverty and that it reflects the state of the society as prisons “make visible what the affluent society did its best to hide” (DISCERN, 1996:21). It also states that imprisonment is a cause of poverty due to income being lost. It stressed that crime is ‘tutored’ within the prison grounds, both directly to the

<sup>76</sup> Very few households stated that they earn more than Lm10,000 (GBP15,000) in 1995.

offender and through him/her to his extended primary network: the family. Poverty Watch also states that imprisonment often led to drug trafficking, an issue that needs further study. An extraordinary mention is the issue where persons resorted to theft in order to pay back fees owed to their lawyers whose fee figures were quite high (DISCERN, 1996: 23). Others mentioned injustices meted by the Law Courts. Whilst no figures are given for both, the fact that these occurrences are reported indicates that causes of crime leading to poverty are varied and have some surprising causal sources. Other causes are self-infliction such as gambling, alcohol consumer habits and at worst partaking in drugs.

Apart from mere mention to the neighbourhood issue, the agencies do not include in their analysis of poverty issues such as residential-commercial-industrial zoning, the dilapidation of specific areas or even stigma given to certain localities, as they concentrate on care at the personal level. However, they state that poverty “as a phenomenon was directly dependent on the social set-up of Maltese society” (DISCERN, 1996:40) stressing that the decision makers were playing a role in the consequences as they pursue the country’s course.

In analysing the issue of indexes of deprivation as against housing, one needs to look at the socio-economic status and the issue of affordability in relation of what makes an area attractive to certain income-level earners. Areas that attract certain levels of income-earners may ‘tip’ towards a situation where that area becomes attractive for ‘social capital’ discrepancies. In view of this, it is difficult to gauge income and in turn affordability mainly due to under reporting. The Malta Economic Survey (2000) reports that the area that registered a higher than average income areas was the North Harbours Local Plan, whilst the South, and North West of Malta registered slightly lower wages than the average, and the Grand Harbour registering drastically lower income.

Interestingly, the latter’s low income and hence a relative poverty status, may indicate a direct relationship to crime, which situation is investigated in Chapter 8.

One has to note that these areas are not homogeneous and have neighbourhoods with different incomes. This may have resulted in poorer urban/village cores with lower incomes (such as the old walled coastal cities), whilst other areas became exclusive due to the high pricing of land such as the area of Madliena in Swieqi. Such situations can be seen in the light of sustainable development as Local Agenda 21<sup>77</sup> (LA21) of the 1992 UN Conference on Environment and Development that looks at the urban form and its relationship inner city decay and crime, amongst others.

---

<sup>77</sup> [http\\www.sustainable\\_cities.com](http://www.sustainable_cities.com)

## Employment Patterns

A 1998 Household Travel Survey (HTS)<sup>78</sup> helped identify the patterns of residential and work locations. The HTS ascertained the distribution of full time gainfully occupied persons residing in each local plan area and sets it against the distribution of full time jobs in each local plan area. The results showed that the Grand Harbour Local Plan area employs 25 per cent of the full time gainfully occupied population, with Central Malta, South Malta and North Harbours Local Plan area each employing around 19 per cent.

Table 5.9 indicates that the Grand Harbour (office-based), Central Malta (industry-based), South Malta (industry-based) and North Harbour (office-based) Local Plan areas have the highest rate of employment centres and subsequently a very high rate of travel-to-work movements. This mainly occurs to the Grand Harbour area, whilst the other areas mainly register inter local plan area movement. The main employment nodes<sup>79</sup> are Valletta, Floriana, Marsa, Birkirkara, Luqa, Sliema, Qormi and Pieta.

*Table 5.9: Percentage Distribution per Local Plan Area*

Local Plan Area	Jobs by Local Plan Area		Economically Active Residents by Local Plan Area	
	Number	Per cent	Number	Per cent
CMLP	26,238	20	37,579	28
GCLP	6,627	5	8,766	7
GHLP	33,947	25	8,500	6
MBLP	3,787	3	4,117	3
NHLP	25,291	19	20,719	16
NWLP	10,955	8	15,672	12
SMLP	25,968	20	37,532	28

*Source: MEPA, 2001*

In view of this, most morning traffic flows towards the Grand Harbour Local Plan, while evening flows are out of the centre towards the urban periphery, where most Maltese live. Most travel occurs through car trips over other modes of transport. The HTS indicated that 70.6% of trips are made by car; fewer than 11.5% were made by bus and 11% by foot. It is interesting to research in future whether crime patterns in Malta follow the relationship between this mobility issue and settlement patterns. This is mainly due to the fact extracted from HTS study that people who live

<sup>78</sup> *Household Travel Survey 1998, MEPA*

<sup>79</sup> An employment node may be defined as a locality that employs more than 3.5 per cent of the full time gainfully occupied population in the Maltese Islands.



in suburban locations and travel to work or school generally use routes not served efficiently by the local public transport system.

### **Retail**

The Retail Sector in the Maltese Islands is dominated by small establishments with over 8,000 businesses in operation in 1995<sup>80</sup>. These are distributed into a four level hierarchy<sup>81</sup> comprising primary, secondary, tertiary and neighbourhood centres, Though mainly non-food centres, these comprise the higher-paying transactions. This study reviews the primary and secondary centres as they are the most important and distinct areas.

The main areas falling under the primary centres (regional function) category are: Valletta, Sliema, Birkirkara, Hamrun, Paola, Victoria (Gozo) and Mosta, whilst the secondary (local function) category comprises Fgura, Qormi, Rabat, Zurrieq, Zabbar, Birzebbugia, Zejtun, Bormla, Naxxar, San Gwann and Mellieha. One can note that these areas cross-over into leisure territory which is to be expected as each activity seeks to attract the parishioners of the other activity. These areas in turn may attract particular crime based on the day and time parameters as well as the distance from the actual activity and the offence, which research questions are investigated in Chapter 9.

### **Leisure and Tourism**

The Maltese Islands can be said to be one leisure and recreation area, which has been developed through changing local tastes for recreation and the influx of tourism with its current annual 1.2 million figure. The leisure industry has generated tourism (like weekend breaks), social content activities, cultural, educational and artistic interests, sports activities as well as informal outdoor recreation (Leisure & Recreation Topic Paper, 2002; Baud-Bovy *et al*, 1998).

The main categories of leisure and recreation that are of interest to this study concern the concentration of certain activities in dense areas. These are especially found where a large number of people congregate (every weekend over 50,000 youngsters and youths converge on Paceville in San Giljan (Leisure & Recreation Topic Paper, 2002; The Times of Malta, 2006). Such a situation may in turn serve as the opportunity of crime. These areas designated as town centres include outdoor recreational areas, catering establishments, land-based/nautical sports and cultural/entertainment attractions. Sub-localities such as Paceville have become an

---

<sup>80</sup> Employment Training Corporation (ETC) data – (Retail Topic Paper, 2001)

<sup>81</sup> Commerce and Industry Study, (1997), MEPA

entertainment *mecca* with the main land-use constituted of bars and restaurants. This concentration of activities has resulted in the highest percentage of crime being registered in these areas: from car theft, to injuries and homicides. In total, over a 1000 leisure establishments can be found over the islands, mainly in Rabat, Valletta, San Giljan, Mellieha, Marsaxlokk, and San Pawl il-Bahar (in Malta) and Xlendi, Marsalforn and Rabat (Victoria - Gozo).

Malta's tourism phenomenon has been fairly recent, having increased from 12,583 tourists in 1959 to 1,215,713 in 2000<sup>82</sup>. This has resulted in the radical overhaul of the island's infrastructure and subsequently changed the way of life for the local citizens. Multi-cultural influences were also introduced and some towns such as San Pawl il-Bahar and San Giljan were engulfed by tourist accommodation.

The main season which sees an influx of tourists is summer and the shoulder months (Table 5.10). This should result in an increased attraction for offenders to act as described by the Opportunity Theory with the main target areas being the recreational areas that tourists seek, which is researched in Chapter 9.

*Table 5.10: Percentage Share of Tourist Arrivals by Season*

<b>SEASON</b>	<b>1989</b>	<b>1992</b>	<b>1994</b>	<b>1996</b>	<b>1999</b>	<b>2004</b>
Winter (Nov-Feb)	18.2%	19.1%	18.7%	19.4%	18.9%	18.1%
Shoulder (Mar-Jun, Oct)	44.4%	44.6%	45.4%	44.6%	45.3%	43.8%
Summer (Jul-Sep)	37.3%	36.3%	36.0%	36.0%	35.8%	38.1%

Source: Tourism Statistics, NTOM, Economic Survey 2005

Seasonal tourism highlights certain differences in accommodation location which may also be analysed for correlation with crime. A tourism & recreation study carried out by the Planning Authority (1996) highlighted that "18.8% of the tourists coming in November indicated that they were staying in San Pawl il-Bahar whilst 28.3% stayed in this locality during the month of August. 3.3% of the tourists coming in January stayed in Mellieha whilst in August 14% did so. 9% of the tourists coming in September stayed in Gozo whilst only 0.9% of tourists coming in February did so. On the other hand, 35.7% of the tourists coming in February indicated that they were staying in Sliema, but this percentage decreases to 16.5% in August. Other areas have experienced a more consistent pattern and these are Marsascala, Birzebbugia and San Giljan" (Tourism Topic Paper, 2001, 31).

Analysis of crime in the Maltese Islands based on the 1990-1999 offender-offence data and on the Police 1998-2003 data would ideally take into account these seasonal changes to detect whether crime trends are tourism-season related.

The frequenters of these areas are both Maltese youths and tourists. Such areas, though focusing on young-age activities, also attract all ages due to their intrinsic recreational and leisure activity.

<sup>82</sup> Malta Tourism Authority, Strategic Plan 2000 - 2002. The figure for 2000 is an estimate.

This would lead to a crime map that indicates which offenders operate in the areas, though this is a difficult exercise dependent on data availability (Chapters 8 and 9). The data has to be seen against a map of land-use for such areas as San Giljan, San Pawl il-Bahar, Valletta, Marsascalea and Sliema<sup>83</sup>.

### **5.3 Crime in Malta**

#### **5.3.1 The law and its effects**

- Legislation

The Maltese Judicial system is based on English Law with influences from Roman Law and the Napoleonic Codes. The main British influence lies in the presumption of innocence, (not guilt, in favour of the accused), the jury system, public law and merchant shipping law<sup>84</sup>.

- Judiciary system and courts structure

#### **The Judiciary**

Malta enjoys a separation of powers, based on the British system, each related but governing its own domain: the legislative (parliament), the executive (Cabinet of ministers), and the judiciary. The latter is served by both Judges and Magistrates who are appointed by the President of Malta, on the advice of the Prime Minister.

#### **The Law Courts**

The Maltese Judiciary system consists of a number of Courts each presiding over its specialized role based on a two-tier system (Table 5.11). The first court: the Court of First Instance is presided over by a Judge or Magistrate whilst the second court is termed the Court of Appeal that hears appeals from the Civil Court, Court of Magistrates, special tribunals and the Criminal

---

<sup>83</sup> In the case of retail establishments situated within residential areas, local establishments provide a research medium that may help distinguish between different retail activities. Though not tackled in this study, it is interesting to note that non-recreational retail may exhibit different issues from recreational ones, such as those based on the parochial networking. Amenities such as small shops provide a major input to the socio-economic and cultural fabric. This is particularly so for the small local grocer that served a close-set of clients who resided within a particular radius around the shop. One particular example of this is found in Valletta where clientele are based on street levels and few persons residing at a certain street level (height above sea-level) would shop from a grocer 2 streets down. This has resulted in a situation of micro-parochialism where the highest person to shop ratio is found in the Grand Harbour area with 93 persons per shop as against the lowest in Central Malta with 237 persons per shop (Retail Topic Paper, 2001).

<sup>84</sup> <http://www.justice.gov.mt/judicialsystem.asp>

Court. Three Judges decide on the sentence when the appeal is from a Court presided over by a Judge, whilst a single Judge presides when the appeal is from a Court presided over by a Magistrate. A further Court concentrates on Constitutional remedies: the Constitutional Court that has jurisdiction on human rights violations and electoral fraud. Maltese citizens, who have exhausted these levels of judicial practice and still seek remedies, have access to the European Court of Human Rights since Malta adopted the European Convention on Human Rights in 1987. In special cases, judgment and imprisonment can also be passed by the parliamentary legislative assembly, with such cases recorded during the 1970s when two persons were sentenced to prison for attempted bribery of a member of parliament. They were sentenced for 60 days imprisonment, on the 13<sup>th</sup> June 1973, through a Mandate from the House of Representatives.

*Table 5.11: Courts in the Maltese Judiciary System*

<i>Court Name</i>
<i>The Constitutional Court</i>
<i>The Court of Appeal</i>
<i>The Court of Criminal Appeal</i>
<i>The Criminal Court</i>
<i>The Civil Court</i>
<i>The Magistrates' Court</i>
<i>The Gozo Courts</i>
<i>The Small Claims Tribunal</i>
<i>Local Tribunals</i>
<i>The Juvenile Court</i>

Source: <http://www.justice.gov.mt/>

Other Courts include the Criminal Court, composed of a judge and nine jurors, and the relative Criminal Appeals Court. Civil cases are handled by the Civil Court through its two Halls: the First Hall covers civil and commercial cases exceeding the jurisdiction of the Courts of Magistrates, whilst the Second Hall is a Court of voluntary jurisdiction in matters of a civil nature, that include adoption, interdiction and successions, amongst others. The Magistrates' Court serves as the forefront for most cases, since they have inferior jurisdiction of first instance in civil matters being limited to claims exceeding Lm1,500<sup>85</sup> but not exceeding Lm5,000. Also, their role in the criminal scenario is mainly based on the trial of offences which fall within their jurisdiction, and also a court of inquiry in respect of offences which fall within the jurisdiction of a higher tribunal. Normally a case that is deemed to merit a higher sentence than that possible through the Magistrates Court is passed on for trial at the Criminal Court before a Judge or a jury. A Court specially set up in the island of Gozo caters as a Court of inferior jurisdiction and

<sup>85</sup> Lm1 is equivalent to approximately GBP1.5

as a Court of superior jurisdiction for civil and commercial cases similar to the First Hall of the Civil Court.

One other court that has a special significance in the fight against early crime is the Juvenile Court<sup>86</sup> which caters for minors under the age of 16 years. A child is deemed criminally responsible at the age of nine, though from nine to fourteen, a person is presumed to be incapable of forming a malicious intent though criminal responsibility can be established where the child acted with mischievous discretion. This intent is deemed capable at age fourteen and imprisonment with a reduced sentence can be sought (Grosselfinger, 1994). These children are catered for by the Juvenile Court. “Malta has one Juvenile Court that was set up in 1986, where action was taken by the Socio-Legal Unit within the Department for Family Welfare, which unit was planned for transfer<sup>87</sup> to Agenzija Appogg<sup>88</sup>. Local rehabilitative measures include Probation Order and Conditional Discharge which do not exceed three years. “Offenders aged less than 16 years are prosecuted before the Juvenile Court where they are treated differently, guaranteed special protection, with hearings closed to the public” (Formosa Pace, 2003:7). If a crime is committed together with adults, juvenile offenders are sentenced together with the adults but the names of the juveniles are withheld. The Juvenile Court may also issue Care Orders.

Different setups are available for other offences or rule breaking. With the introduction of various laws such as labour-related laws, traffic-measures, etc, new systems were launched such as the small-case Tribunals that cater for depenalised offences with a maximum fine not exceeding the sum of Lm1,500. The introduction of Local Tribunals helped shed some weight from the law Courts as they cater for minor infringements of the law such as traffic offences, school truancy, etc. These courts may be presided over by a Commissioner of Justice who may be a lawyer. The Law Courts still offer final remedy on a point of law, to cater for any miscarriages of justice or otherwise from such local courts as the Local Councils Tribunals, the planning decisions system and other sentencing practices.

### **Sentencing practice**

Sentencing in Malta is governed by the judge or magistrate who delivers the sentence, though in the Criminal Court it is the Jury (where called) that decides on the outcome whilst directing the presiding Judge who then commutes a sentence degree relative to the votes cast (9-0 unanimous, 8-1, 7-2 and 6-3). Sentencing practice is given special hearing through pleading by defence lawyers and the prosecutors at the end of a trial or at sentencing hearing. No person who appears

---

<sup>86</sup> Juvenile Court Act: Chapter 287 of the Laws of Malta, 1980

<sup>87</sup> [www.msp.gov.mt/documents/family](http://www.msp.gov.mt/documents/family)

<sup>88</sup> [http://www.appogg.gov.mt/aboutappogg\\_overview.asp](http://www.appogg.gov.mt/aboutappogg_overview.asp)

before the Courts is deprived of any necessary services such as professional backing as well as lay or religious persons (Grosselfinger, 1994).

### **Jury System**

Where offenders are apprehended they may opt to go for the jury option for a number of reasons. Schrag *et al* (1997) argue that the jury system hinges on two issues: the belief that a defendant's guilt depends on the juror's belief in the way the justice system operates and prior belief about the defendant. An accused's location such as that hailing from an area labelled as 'dangerous' and 'criminal' could impinge on the decision regardless of the actual case under study.

This may also occur in cases of drug trafficking, where in Malta, for example, juries occurring during high spates of drug overdoses may result in biasing the jury in favour of guilty verdicts. The media and sentimentalism have a major role to play in these events, irrespective of the impartiality that jurors should operate within. This results in pre-jury knowledge of the case, where Maltese jurors are very rarely unaware of a case's circumstance, due to the Islands' insularity.

Also, the final verdict may not truly reflect the type of crime committed and level of seriousness. In Malta, for example, rarely do juries reach a 9-0 verdict against the accused, in the belief that an unanimous verdict of 9 guilty against 0 not guilty exposes the jury members (chosen by lot) to potential reprisal by the accused or his/her connections. The eventual sentences of 8-1 are also rare and 7-2 quite common. The result is however of concern, for each of these steps the level of sentencing is reduced drastically, from life (9-0) to 20 years (8-1, etc). This said, the 1990s saw a number of 9-0 verdicts, both for foreigners and increasingly for Maltese citizens.

Chapter 9 of the criminal code lists the crime types and the sentencing that should be relevant to that crime. Thus penalties vary according to the crime from a mere admonition to life imprisonment. The death penalty was abolished in 1971 for ordinary crimes, where the last person to be sentenced to death by hanging was executed in 1943. The last person sentenced to death but was not executed was Giga Camilleri who was accused of murdering her son Twanny Aquilina on the 23<sup>rd</sup> August 1960 and was eventually released 9 years later – her husband got 20 years and served 8<sup>89</sup>. The case that shocked the nation has been intensively researched<sup>90</sup> and has

---

<sup>89</sup> Borg J., and Azzopardi J., "Kif tista' omm toqtol lil binha?" – Giga, Il-Gens, 22 October 1993

<sup>90</sup> Zammit R.G. (2006), 'Capital Punishment In Malta' Depth Analysis of a death sentence., unpublished BA Criminology thesis, University of Malta

acquired folklore status<sup>91</sup>. Eventually, the death penalty for cases of treason in time of war was repealed in 2000.

Penalties are meted based on the type of offence: contraventions are awarded detention, fines (Ammenda) and reprimand or admonition; crimes are awarded imprisonment, solitary confinement, interdiction, and fines (Multa). Fines may be converted to imprisonment should the offender default on payment. Serious crimes such as arson and homicide are generally awarded imprisonment, whilst less serious crimes such as illegal entry into the Islands are usually given deportation upon conviction, and offenders may even get a suspended sentence which legislation was introduced in 1990<sup>92</sup>.

An analysis of the remedies available in Malta to persons who have been sentenced indicates that there is more than meets the eye when following the actual sentencing. In all cases except imprisonment for life without the possibility of benefiting from an Amnesty, inmates are occasionally awarded Amnesties<sup>93</sup>. This system of administration of justice may be aimed at helping in rehabilitating offenders but research is needed to evaluate the impact of Amnesties on the factors of retribution, rehabilitation, and deterrence. Though Amnesty may sound similar to parole, there are no binding terms on the ex-inmate to serve as a deterrent.

In Malta, the Amnesty issue is a strange animal where two levels are found. One is where an individual is awarded an Amnesty based on a justifiable reason such as on health grounds, though even this justification is controversial as happened in the case of Brazilian drug runner Francesco de Assis Queiroz, who was granted a presidential pardon on 26 September 1994 after being diagnosed with hepatitis, a common ailment in prison. The second type of Amnesty is also controversial in that it is a sweeping measure where all prisoners (sometimes less those sentenced for very serious crimes) are awarded a part-reprieve of the sentence. In some cases, this meant immediate release and may have resulted that these persons eventually re-committed crimes during the early release period. Mass Amnesties have been awarded for a variety of reasons; religious (appointment of new Archbishop, Pope's visit); political (appointment of new government, appointment of a new President); legislative (Constitutional amendments), and one-offs (New Year's Day, visit by some foreign dignitary) (Attard, 2000). This practice was stopped

---

<sup>91</sup> Abela M., (accessed on 4th April 2006), *Delitt Orribli Ta' Omm Li Qatghet Ras Binha, li grat fit-23 ta' Awissu 1960* - <http://www.allmalta.com/ghana/fatti20.html>

<sup>92</sup> Suspended sentences have reached a very high proportion in the late 1990s, where 1 person was awarded such a sentence for every 4 awarded imprisonment. Technically these persons have been served a sentence, which becomes effective should relapse occur within the stipulated suspended period.

<sup>93</sup> Since 2000, a stringent policy has been adhered to, where Life means Life, without any chance of release. The Minister for Justice and Home Affairs, Dr. Tonio Borg was quoted on the *In-Nazzjon* dated 13<sup>th</sup> February 2002 stating there is a misconception that Life means 20 or 25 years as Life actually is non-interpretible as it means Life for the convicted with no chance of release except through a Presidential Pardon.

in 1999 when the last Amnesty was awarded during the Millennium celebrations, albeit of one month's period<sup>94</sup>.

Another related issue concerns Remission. Maltese prison inmates are awarded a 1/3 remission on their sentence which means that effectively for each year sentenced they serve 8 months. Should they commit misdemeanors whilst incarcerated they are awarded points which are days added back to their stay in prison, but these are generally signed off before release. Once again, this calls for a future study that could analyse whether crime is committed within the period when the full sentence should have been operative.

- Police and Enforcement agencies

### **Prison**

There is just one active prison in Malta, though a number of cells in police stations and other locations can serve as prison facilities. These include a hospital ward, a drug facility in Mtaħleb (SATU<sup>95</sup>), Police General Headquarters and the Law Courts. The Corradino Correctional Facility, better known as CCF at Corradino Hill, was established under Ordinance of 1<sup>st</sup> September 1849, following the closure of prisons in Valletta (males), Floriana (females), and Gozo (Attard, 2000).

Prison population in March of 2006 totaled 331, composed of 231 Maltese and 100 foreigners. A further breakdown lists 174 convicted Maltese and another 48 under arrest, and 57 convicted and 52 arrested foreigners (Times of Malta, 16th March 2006).

The prison is staffed by specially-trained warders, though police officers also carry out this duty, under the management of a Director of Prison. This system, though criticized by the European Committee for the Prevention of Torture, is proving difficult to ameliorate due to human capacity and lack of trained personnel<sup>96</sup>.

### **Police**

The Malta Police Force was founded on the 12th July 1814, with the General Headquarters based in Floriana (Cauchi, 2001). It was set up from six different Civic Guards bodies, which were

---

<sup>94</sup> The 1999 Amnesty was not received very enthusiastically by the inmates, who had been used to a veritable handout situation and had expected a major release period. The author was gathering data from the CCF for this research and could tell that the inmates were not pleased with the outcome.

<sup>95</sup> SATU – Substance Abuse Therapeutic Unit

<sup>96</sup> <http://www.cpt.coe.int/documents/mlt/2002-17-inf-eng.htm>



responsible for law and order. The abolition of slavery and torture, as well as the right of sanctuary of criminals in churches in July 1814 by Sir Thomas Maitland also saw the abolition of the Civic Guards and the introduction of the Police Force. These were composed of “two departments – the Executive Police who were under the command of an Inspector General, and the Judicial Police under the charge of a Magistrate” (Cauchi, 2001). The latter structure was still found as the main Court components prior to changes in the Court system in the late 1970s when the Court became the Magistrate’s Court, where police still conduct their own prosecutions and assist the Office of the Attorney General at the Superior Courts.

Ironically, the police force has not been without its own crime episodes. It is not rare to find a police member sentenced to serve a prison sentence including drug dealing, indecency, theft, bribery, blackmail, illegal arrest, cultivating Cannabis Sativa, rape, escape from prison and homicide. In fact, the Police Force got its worst award in 1993 when its Commissioner was sentenced for 15 years imprisonment for complicity in the homicide of a suspect within the Police General Headquarters. This said, these are individual instances and the force is generally respected and provides a sterling service to the public.

The Police Force is administered by a Commissioner whose holders have introduced reforms over time such as the recruitment of Women Police Constables in 1955, Interpol membership in 1971, use of high-tech and the launching of intelligence units. The Police Force is composed of about 1,800 persons, which equates to a ratio of one police officer for approximately two hundred citizens. Though the main responsibilities lie in the provision of public order, peace, and the prevention and detection of crime, the police force has suffered as similar bodies in other countries; incidences of deaths of policemen on duty (Zammit, 2004; Zammit, 2005), human resources as well as the impact of bureaucracy. Police reforms have now ensured that the police are more visible on the streets.

The main act for success in reducing crime in Malta is to have a working relationship with the community, either through direct intervention or through the Local Councils in such schemes as the Neighbourhood Watch (launched in 1991), foot and mobile patrols, CCTV<sup>97</sup> and an Automatic Vehicle Location (AVL)-based Rapid Response System that ensure that mobile units are promptly and accurately deployed to scenes of crimes or incident” (Cauchi, 2001). They also find help here through the introduction of Local Enforcement where minor offences are dealt in the locality of commission and thus it is more difficult for the offender to maintain an aura of distance as happens in the Valletta Law Courts where persons are ‘not’ so well known.

---

<sup>97</sup> CCTV – close circuit television

Also, local wardens<sup>98</sup> help the police to control offences related to traffic, littering, environment awareness, whilst other enforcement agents from the major organisations such as the Malta Environment and Planning Authority's enforcement officers have very specific roles related to their organisation's function. Additional services to help curtail crime include services to drug abusers through a methadone-distribution system. One needs to analyse whether this system has helped reduce the number of drug-related crime as methadone may serve as a replacement for hard drugs, where the prevailing philosophy states that there would be no need to illegally obtain money for drug-taking. However, it is known that drug abusers take methadone as an additional intake to their daily drug dose; a difficult topic to study.

### 5.3.2 Malta categories of crime

#### **Classification of Crime**

Maltese Criminal Code distinguishes between crimes and contraventions, with crime considered as the most serious (Grosselfinger, 1994). Grosselfinger lists Crimes as including "treason, coup d'etat, insurrection, wilful homicide, bodily harm, theft, receiving stolen property, misappropriation, assault and resistance against police officers, bribery, abuse of power, rape, prostitution, indecent assault, defilement of minors, forgery, fraud, perjury drug abuse and trafficking, money laundering, electoral fraud, and counterfeiting of money. Contraventions include disturbance of public peace, swearing, unlawful betting, various traffic offences, dumping of garbage, failure to pay maintenance, drunkenness, vagrancy, and threatening. These crimes and contraventions are found both within the Criminal Code, the Code of Police Laws and various Acts of Parliament (Grosselfinger, 1994).

Crimes reported to the police from 1998 to 2001 covered the categories and sub-categories listed in Table 5.12.

---

<sup>98</sup> <http://www.les.gov.mt/>

Table 5.12: Crime categories and Sub-Categories reported to the Police: 1998-2001

Category	Sub Category
Abortion/supply of poisonous substance	
Abuse of public authority	
Abuses relating to prisons	
Against morals/honour - family	
Arson	
Attempted offences	Attempted arson
	Attempted bodily harm
	Attempted damage
	Attempted homicide
	Attempted sexual offence
	Attempted theft
Bankruptcy offences	
Bodily harm	Domestic violence
	General bodily harm
Computer Misuse	
Concealment of bodies	
Crimes - religious sentiment	
Crimes against public peace	
Crimes against public safety	
Crimes vs. admin of justice etc	
Damage	By acid
	By explosion
	By paint
	By shot
	General damage
	Hit and run
Drugs	
Forgery	
Fraud	
Homicide	
Immigration	
Infanticide/abandon. Of child	
Malversation by pub. officer	
Perjury & false swearing	
Prostitution	
Safety of the government	
Sexual offence	
Theft	General theft
	Hold-up
	Pick-pocketing
	Snatch and grab
	Theft from bars/hotels
	Theft from beaches
	Theft from factories
	Theft from residence
	Theft from retail outlets
	Theft from sea craft
	Theft from vehicle
	Theft of sea craft
	Theft of vehicle
Threats and private violence	
Violation of places of confinement	
Violence against pub. Officer	

A UNICRI<sup>99</sup> review of crime<sup>100</sup> shows that Malta ranks among the highest twenty countries in

<sup>99</sup> United Nations Interregional Crime and Justice Research Institute (UNICRI)

<sup>100</sup> [http://www.nationmaster.com/graph-T/crime\\_tot\\_cri\\_cap](http://www.nationmaster.com/graph-T/crime_tot_cri_cap)

the world for total crime per capita where 43.59 per 1000 persons were subjected to some category of crime<sup>101</sup> (Table 5.13). With over 17,000 crimes in 2002 alone this is hardly surprising, though statistics provided by UNICRI may not include the number of tourists who may fall victim to predators. Malta compares as relatively safe compared to such countries as Dominica at 111.99 per 1000, the UK with 85.6 and the US with 84.39. However, it is high compared to such countries as Mauritius with 29.95, Hong Kong with 11.03 and Yemen 1.29 crimes per 1000 persons. Note must be taken at this stage that such figures are only as relevant as the reporting structure existing in a country; thus a country such as Yemen may have higher rates but crimes are not reported or deemed as not constituting an offence as listed in other countries. This applies throughout the list.

*Table 5.13: Crimes per 1000 persons – a country comparison*

Rank	Country	Description
1	Dominica	111.99 per 1000 people
2	New Zealand	109.32 per 1000 people
3	Finland	102.3 per 1000 people
4	Denmark	93.92 per 1000 people
5	Chile	90.97 per 1000 people
6	Montserrat	89.01 per 1000 people
7	United Kingdom	86.5 per 1000 people
8	United States	84.39 per 1000 people
9	Netherlands	81.26 per 1000 people
10	South Africa	78.42 per 1000 people
11	Canada	77.63 per 1000 people
12	Germany	75.25 per 1000 people
13	Norway	72.94 per 1000 people
14	France	63.11 per 1000 people
15	Seychelles	53.65 per 1000 people
16	Hungary	44.67 per 1000 people
17	Malta	43.59 per 1000 people
18	Estonia	40.83 per 1000 people
19	Italy	38.22 per 1000 people
20	Czech Republic	38.17 per 1000 people
58	Azerbaijan	1.79 per 1000 people
59	India	1.69 per 1000 people
60	Yemen	1.29 per 1000 people
	Weighted Avg	25.81 per 1000 people

Source: Seventh United Nations Survey of Crime Trends and Operations of Criminal Justice Systems, covering the period 1998 - 2000 (United Nations Office on Drugs and Crime, Centre for International Crime Prevention)

<sup>101</sup> Note that this data refers to the resident population and does not cater for such variables as tourist numbers and number of illegal migrants

### 5.3.3 Available research

- Review of local crime studies

Crime-analysis in Malta is still in an embryonic stage and very few studies have been carried out. One study identified that recidivism in Malta approximates that in other societies even though socially and culturally the islands are different (Baumer, 1997). Other studies looked at the psychological and sociological backgrounds of young offenders (Bell, 1994; Clark, 1999) which identified career trajectories based on contingencies in youth offenders who were incarcerated (Clark, 1999). Another study identified that persistent (career) offenders start early and that their behaviour mirrors the individual, family, peer and social environments in which they are brought up (Formosa Pace, 2003). The options for change in which young offenders find themselves are limited, criminal activity persists and escalates toward adulthood.

A study on generic crime and serious crime in the 1980s attempted a first in analogue locational analysis where crimes were analysed by police district (regions) (Tanti Dougal, 1994). Though by no means an attempt at spatial crime analysis and GIS, the study tries to analyse crime by region and identified that trends are visible for crime types by year and by area such as tourist areas. The later part of the study then deviates from the strategic aspect and delves into sociological constructs such as family crime (incest, marital rape and spouse battering). Another study looked at the impact of town planning (architectural value) on crime in Housing Estates in Malta (Vancell, 2003).

Other studies relate to the pre-World War II and earlier centuries crime mostly at the legal aspects of crime (Lauri, 1980; Cremona, 1999). Another study on disposal rates in Maltese courts in the period 1979-1998 identified that the number of cases exhibits a linear relation with the number of magistrates and judges whilst a direct relationship existed between the number of disposed and introduced/pending cases (Buhagiar, 2000). In effect, the main research slightly related to the current study is Tanti Dougal's. Baumer's and Vancell's work are limited in spatial analysis, which makes it difficult to form a comparable basis on crime patterns in Malta from the available literature.

### 5.3.4 Summary

The Maltese Islands have an integrated socio-cultural and socio-economic profile where each of the sociological pillars of politics, religion, education, family and the economy have had their own impact in shaping the Maltese reality. With a humble beginning, colonial dominance gave way to an extended service industry that caused major rapid social and economic upheavals.

This chapter aimed to provide the reader with a reference to the different constructs that may have an impact on the generation of crime or of victims of crime. Pressures are wide and varied yet are meshed together: religious with political, recreational with land use, poverty with social and community structures, amongst others. The culture is varied and describing it in face of little previous crime studies is a difficult yet challenging task. Setting the scene for data analysis is vital in such studies as the different parameters are laid out for investigation, as is the case in the next chapter.

Social pattern analysis and the potential link to landuse and crime issues have been described in this chapter. These exist in diverse forms and help to better understand society. This refers particularly to historic links where patterns may show up better in areas that have suffered from sprawl, population loss, historic neglect and economic variance. These topics shall be analysed in detail in Chapters 7 to 9 that relate to the spatio-temporal crime analysis and its relation to social and landuse issues, based on the methodologies outlined in Chapter 6.

## **Chapter 6: Methodology**

### **6.1 Methods introduction**

This chapter covers the methodology employed in the study. It concentrates on the approaches taken, the data gathering process, the problems of access to data, and the spatial concept to the study. It starts by describing the background of the methods employed, and then covers the quantitative and qualitative options available to the researcher. The next section depicts the issues encountered in the process to gather crime data in Malta, mainly source identification, inputting, and verification. It guides the reader through the geocoding process employed that makes the jump from tabular to spatial data possible and the inherent issues and problems encountered.

The chapter looks at the data analysis function, the techniques employed and the outputs envisaged. An analysis of the available datasets and their reliability is carried out together with a depiction of the spatial data levels created for this study.

#### **6.1.1 Background to methods used**

Most studies in the social sciences employ either qualitative or quantitative analysis or varying combinations of the two. The main emphasis in this study is quantitative methods with a strong spatial analysis component. In order to understand the remit of such a study, it is essential that spatial concepts be well-understood and ingrained, particularly the querying measures employed in spatial analysis. The concept of analysing crime from a spatial viewpoint allows the researcher to envisage new inputs to knowledge without sacrificing the statistical construct.

Should the study have employed basic statistic measures from a purely thematic perspective, results would have shown the criminological construct of the Maltese Islands in terms of crime category changes and the permeating interactions, in terms of longitudinal and cross-sectional approaches. This aspect of the research is taken into account in the first analytical chapter (Chapter 7) that analyses Maltese crime in the European and Island perspectives as well as giving a historical outline of crime over 50 years from 1950 to 1999.

As the study aims to go further, more detailed analysis at large-scale requires spatial methodology. The spatial dimension takes the study one step further in that it injects new blood in the analysis function: data can now be analysed in three dimensions: thematic, temporal and spatial. These issues are tackled in the later chapters.

At the initial stages of the research there was little, if any, data available on crime in Malta and definitely none in a digital format. Such a situation entailed the initiation of a long process of data mining, gathering, cleaning, data base design and geocoding prior to any attempt at analysis.

In addition, the author's decision to adopt a 100% coverage (i.e. analysis of all the available data rather than sampling) of any data gathered for the islands increased the pressure on the data gathering process. This was done to make sure that any relationships in such a micro-state as Malta may be analysed to the most detailed scale, as some crime types may only occur in one area that is synonymous with a specific activity and that may fall out of any sampling methodology used. In effect, having recognised the implications of such a decision, this process was initiated in 1997<sup>102</sup>, with six full years of data gathering and two for data cleaning and georeferencing, with new data still being acquired whenever available.

This method was followed as it ensured that it would lay out a solid foundation for any future research on criminality in Malta. It would also ensure that enough material has been gathered in one repository to enable an enhanced analysis process, both within tabular statistical and spatio-statistical analysis.

### 6.1.2 Quantitative and Qualitative approaches

In the analysis of crime, Bottoms and Wiles (2001: 13) state that one of the problems that has 'bedevilled' environmental criminology theory since the Chicago School and is still unsolved concerns the relationship between the various procedures used to analyse crime. They state that 'social activity' needs to be analysed in terms of a multi-level approach: 'hot spot' analysis dealing with concentrations of offences, person-person interactions dealing with offender-victim issues, and response of the social actors to the physical aspects of the location. In effect, this brings together quite a diversity of methodological issues. The 'hotspot' analysis necessitates the activation of a quantitative approach using high-end GIS and statistical tools. Hotspot analysis can be analysed through the NNA<sup>103</sup> and NNH<sup>104</sup> as well as the Getis-Ord **G**<sup>105</sup> Statistic, the Moran **I**<sup>106</sup> Statistic, the **K**<sup>107</sup> Function Statistic, and latest GAM clustering methodology (Craglia *et al*, 2000).

---

<sup>102</sup> This research was officially initiated in 2001, but the data gathering process was started in 1997, considering that the researcher had previous experience of how long the data gathering and access process take in Malta, as well as the width of data gathering scope in crime research.

<sup>103</sup> NNA – Nearest Neighbour Analysis

<sup>104</sup> NNH – Nearest Neighbour Hierarchical Spatial Clustering

<sup>105</sup> The Getis-Ord Statistic tests for the overall tendency for large or small attribute values to cluster together in the search area.

<sup>106</sup> The Moran Statistic tests for an overall tendency towards spatial auto correlates in the attribute values across the search area.



The person-person interactions call for knowledge of these same interactions either through ethnographic studies and participant observation research, amongst others. In the case of the response of the physical actors the interview or survey method would be appropriate. This methodology was used by Wang (1999: 64) in his study that included the exploratory (quantitative – forecasting at macro level) and explanatory (qualitative – daily social life that individuals anticipate).

In the Malta study, the quantitative approach is taken; the initial study investigates the offender rate over a 50-year (1950-1999) period. This is complemented by a detailed study spread over 10-years (1990-1999) focusing on both offender and offence data.

### **The quantitative process**

The study relies heavily on the quantitative approach. This is a natural constraint once the decision to go for a spatial perspective was taken. The approach called for a highly numeric approach particularly since the whole Maltese parameter was employed. It also entailed gathering data from a large number of analogue sources, again rarely digital.

Though complete parameters were chosen, the process itself entailed some high level use of sampling methodology. This was based on different methods according to the type of study being undertaken, such as purposive sampling where the offenders chosen were those who had been incarcerated as against all ‘guilty’ offenders. The method was also employed when choosing offence data from the incarcerated dataset where only the last decade of the century was taken. This sampling method was both scientific and practical as data on all sentenced persons is not made available and where it is available, consistency in attribute input is not always reliable.

This reliability issue crops up due to an inconsistency in data recording at the Courts of Malta, where data has yet to be centralised and quality controlled. In addition, data from the Courts is difficult to acquire access to and are dispersed in a number of court rooms, departments and sections. This said, the latter situation is being rectified where since 2001, on-line sentencing information is being disseminated in Maltese<sup>108</sup>. Sentences are inputted as dictated by a judge or magistrate and the documentation does not have any sociological data as needed for research purposes such as recidivism and background studies. Dissemination of such data would break the legislative safeguards on data protection and human rights, amongst others.

---

<sup>107</sup> The K-Statistic tests for point pattern properties at a continuum of well-defined scales by computing the K-Statistic at specified distance bands around each point as in the Getis-Ord global Statistic.

<sup>108</sup> <http://www2.justice.gov.mt/sentenzi/default.asp?lng=ENG>

In view of the above restrictions, a decision was taken in 1997 to identify the available crime data sources and to choose those available for research. Once certification was made that court data was not accessible and that no comprehensive digital data existed in the Courts, that source was considered too tedious and bureaucratic to embark on and was subsequently discarded. The next data sourced included generic crimes statistics (available from COS<sup>109</sup> in book format with digital versions since 1998), crimes reported to the police and prison statistics available in ledger format for over 150 years. Both the police and prison data were chosen and a process of digitisation initiated.

The decision to analyse prison records was taken as it is the only crime data repository where information is held literally “secure behind bars” and in one place. This dataset provides data on the ‘hardcore’ or at least the most reliable source of persons who have been truly convicted by law and have a proven direct and severe relationship to crime<sup>110</sup>. Analysing suspects and arraigned persons may depict a different outcome of what makes an offender as a large number would be acquitted. Thus those convicted have gone through the whole process and have been filtered by police, society and law.

This also bears on the fact that studies on crime need also to analyse whether incarceration is providing enough deterrence value in the strive to contain crime. Wolpin (1978 in Entorf et al, 2000: 83) in his studies of England and Wales lists 5 variables that should act as deterrence variables, which variables can be termed to represent the different types of sentencing levels that can serve as surrogates for criminal analysis.

- a) clear up rates (crimes cleared by police);
- b) conviction rates (proportion of arrested pleading guilty or are convicted);
- c) imprisonment rates (proportion of guilty who are imprisoned);
- d) recognizance rate (proportion of guilty who are on recognizance<sup>111</sup>);
- e) fine rate (proportion of guilty who are fined);
- f) average sentence (average length of the court sentence for those imprisoned)<sup>112</sup>.

---

<sup>109</sup> Central Office of Statistics currently renamed to National Statistics Office, which publication series “Abstracts of Statistics” hosted Crime-related data, which data was discontinued since 1998.

<sup>110</sup> As against other sentenced persons who are given a suspended sentence as they were not deemed ‘too dangerous’ to warrant incarceration.

<sup>111</sup> An obligation of record that is entered into before a court or magistrate, containing a condition to perform a particular act, such as making a court appearance. Also known as a pledge. <http://www.thefreedictionary.com/recognizance>

<sup>112</sup> One has to note that the severity of sentence relates to the sentence proscribed by law (as a minimum and maximum incarceration period or fine, etc). However, the judicial person (Judge, Magistrate and Commissioner of Justice) interprets the law in his/her own way and sentence lengths may vary within those same boundaries.

In the Malta case some of the data may not be available, however Entorf *et al* (2000) state that normally at most only two variables are used in most studies.

In the case of this study, Awaiting Trial offenders were not included due to the fact that a number of these persons may be acquitted or their cases remain open for a considerable period of time as well as being converted to Full Imprisonment files once convicted, a process that may result in double-counting. Thus the c) category was chosen for this study.

### **The qualitative process**

The other methodological process is based on the qualitative aspect of research. Craglia *et al*, (2000: 713) state that in order to deliver a programme for the analysis of crime and the preparation of measures to combat crime, a series of issues need to be accounted for:

- i) the development of plans based on detailed analysis of local crime problems
- ii) ensure the coordination of police and public-sector agency services in crime prevention initiatives
- iii) propose a 'joined-up' government with the integration of deliverables of all public services at local level in order to ensure effectiveness.

Wang (1999) also posits the use of a panel of experts for the analysis of micro-data, examining their opinions and synthesising the likelihood of the development of the targeted phenomena, by including politicians, civil servants, members of the business community and residents.

Following the conclusion of this study, the author aims to launch a long-term process to bounce the results of this study off persons in the square-of-crime, such as the police, local councils, justice administrators and ministries.

### **6.2 Data gathering exercise: the process and the hurdles**

As indicated earlier, the data gathering process took up the greater part of this study, particularly due to the lack of any digital data. This was particularly critical in the crime-related field such as convicted offender and convicted offence data, and national statistical compendiums. Where digital crime data was made available, a process of validation as well as geocoding and georeferencing was undertaken.

The main issue that needs to be mentioned at this stage concerns data currency. As the study looks at 50 years of crime, gathering this information at national level was possible. In other cases the data is only available for the last ten years of the century, particularly since offence

data was only kept in storage since the late 1980s and quite a few of the initial files were badly deteriorated having been eaten by mice and other creatures. In other cases data is only available since 1998, such as the police reported data. However the author managed to acquire data from the 1995 Census of Population and Housing at enumeration level<sup>113</sup>. This makes it possible to analyse offender-offence relationships as against the socio-economic data of the 1990s.

The next section reviews the methodological process employed in the data gathering process.

### 6.2.1 Source identification

Digital data was even harder to find and most has to be inputted from scratch. In fact all data pertaining to this study except for the 1998-2003 policed data on reported crime has been inputted by the author. Data from the NSO crime statistics prior to 1990 was also manually inputted. GIS data on crime is virtually nonexistent, except in the MEPA planning system where infringements on development (that may be taken to Court) are mapped in a GIS system, but are technically not relevant to this study.

The data sourcing was one of the main concerns of this study, mainly due to access issues, analogue formats, permissions required, data-mongering and major bureaucratic issues. Whilst identifying the data sources for the different themes entailed a straightforward approach, the main problem was getting to the data.

The first step taken involved coming up with a list of datasets that would prove essential to this study and acknowledging the fact that it may not be gathered in time for the analysis. Crime data in Malta exists mainly in analogue (paper) form and to a lesser but greatly restricted extent in digital form. Malta has a history of data-mongering where each data creator is called a data guardian who does exactly that: data is hoarded and made inaccessible to any but the holder. This culture is giving way to a more open system where data availability on the web has helped break the hoarding mentality. Data is made available without compromising individual protection. Citizens are protected through the Data Protection Act<sup>114</sup> (Chapter 440)<sup>115</sup> enacted in 2001 and brought fully into force on the 15<sup>th</sup> July 2003<sup>116</sup>. The data is administered by persons called *"controller of personal data who alone or jointly with others determines the purposes and means of the processing of personal data"*<sup>117</sup>.

---

<sup>113</sup> Data from the Census of 2005 is not yet available.

<sup>114</sup> Other laws include the Patents & Inventions Protection, and Copyright Protection – [www.justice.gov.mt](http://www.justice.gov.mt)

<sup>115</sup> [http://docs.justice.gov.mt/lom/legislation/english/leg/vol\\_13/chapt440.pdf](http://docs.justice.gov.mt/lom/legislation/english/leg/vol_13/chapt440.pdf)

<sup>116</sup> "The Data Protection Act 2001 provides for the protection of individuals against the violation of their privacy by the processing of personal data and for matters connected therewith or ancillary thereto." - <http://www.legal-malta.com/law/data-protection-malta.htm>

<sup>117</sup> Government of Malta, (2001), Chapter 440 Data Protection Act, ACT XXVI of 2001, Valletta, Malta

Social data was sourced from a number of organisations including the National Statistics Office, the Ministry for Social and Family Affairs, the Education Department, the Health Department and Planning Authority. Due to the sensitivity of these datasets, access was requested directly from the Ministers involved or Director Generals as well as the Prime Minister's Office.

Land Use data was sourced either directly from the organisations archiving them or indirectly through value added datasets acquired by third-party organisation from the original sources. The latter were primarily sought from the Planning Authority – later called the Malta Environment & Planning Authority, Water Services Corporation, Local Councils Department, National Statistics Office, and Malta Transport Authority<sup>118</sup>.

Permission was sought and approved quite rapidly by the Director of the Planning Authority. The tabular and spatial data entailed cleaning, organising, aggregating<sup>119</sup> and restructuring. This was necessary as the data was not originally intended to provide for social matters, effectively rendering most of the datasets 'ineffective' or unusable. However, new maps were created based on the datasets, with major recoding in such layers as address point database, street layer and enumeration areas.

When crime data is sought, however, analogue data was and is still very difficult to access except for National Statistics Office<sup>120</sup> publications and parliamentary questions results. The Police Annual reports are not made available to the public and have not been made available even for this study. Data on court cases follows the same route and only since 2001 have cases started being published through a web-enabled database portal<sup>121</sup> though in some instances records are incomplete since not all courts insert data in the system. To make it even harder, all documentation and information pertaining to offenders has a timestamp on it and information on persons who were/are incarcerated have an 80-year moratorium on them thus making the data for this study practically impossible to access. The data for the offenders of the 1950s will only be available in 2030 whilst the data for the 1990s which is needed for the offender-offence analysis will be available next in 2070. Special permission to access and digitise this restricted data was sought and granted from a series of Justice Ministries and CCF Directorships.

---

<sup>118</sup> One must stress at this point regarding debatable pricing policies for research purposes by certain agencies. The Malta Transport Authority insisted on the payment of GBP750 for a bus-stop data layer that was incomplete and potentially erroneous as well as demanding a copy of the results emanating from the study. Such large sums for doubtful data sources and at such high prices shows an ingrained lack of regard to scholarly activities.

<sup>119</sup> Aggregation refers to the process of combining highly detailed data in grouped and generalised categorised such as local councils data being aggregated into district or national data.

<sup>120</sup> National Statistics Office, Malta: <http://www.nso.gov.mt>

<sup>121</sup> <http://www2.justice.gov.mt/sentenzi/default.asp?FrmSearch=2&lng=ENG>

Finally, crime data was sourced from the National Statistics Office, Corradino Correctional Facilities (CCF - prison), Ministry for Justice and Home Affairs, Education Department, Police Force, and the National Archives. Once again, the sensitivity of the data called for highly specific access requirements such as access to prisons, police headquarters and other sensitive individual data holders. In return, the results from the crime classification exercise, as created by the author, were forwarded to the Police IT department<sup>122</sup> for consideration in their PIRS (Police Incident Reporting System) categorisation. The Classification system and the creation process is available in Appendix 3 in its initial Maltese category pre-1997 and post 1998 lists as well as the final integrated list comprising the Maltese categories and the UK categories as extracted from the Huddersfield Kirklees 4<sup>th</sup> Crime Audit<sup>123</sup> (2001).

In the crime data case, other data gathering problems faced by the author were policy and legislation related such as access to data, access to prisons, access to personal data, and the normal bureaucratic issues such as that faced in the concerned government departments, prison and crime-related entities. The process was both enabled through contacts and goodwill by individuals within each organisation and on the other hand impaired by other individuals who either sought to reduce access or in one case to terminate the data gathering process, quoting prison regulations. The latter situation was diffused through a meeting with the Minister for Justice and Home Affairs who re-granted access to the prisons. Other not-so-drastic bureaucratic issues but equally disrupting were re-access to prison data once a change in government occurred: new ministers, new directors of prison, and other new officials.

Other data was gathered through surveys and questionnaires. One such was termed the Dark Figure of Crime Survey<sup>124</sup>. The survey was distributed to 300 MEPA employees who were asked to report any crimes over 5 years and whether they filed reports to Police. However, both the sample and the reply rate was too low to enable reliable analysis and the author decided that it would not be included, though the framework is now ready for a larger run post this-study.

The above exercises sought and reached the guidelines set out in the research objective (2) that sought to review the data availability in the Maltese Islands in the fields of crime, social issues and land-use aspects. It sought to review and compile the data into digital format for future studies and analysis. This was possible through the conversion from analogue to digital format. As expected, the digitisation process took up the larger part of the research period.

---

<sup>122</sup> [www.pulizija.gov.mt](http://www.pulizija.gov.mt)

<sup>123</sup> [http://www.crimereduction.gov.uk/audits\\_and\\_strategies/kirklees.doc](http://www.crimereduction.gov.uk/audits_and_strategies/kirklees.doc)

<sup>124</sup> Dark Figure of Crime: Crime Reporting Survey was programmed in Lotus Notes by the Applications and Software Development Manager within the ICT Unit at MEPA and results were exported to CSV format. The survey was sent to employees as an email, which triggered the interface and respondents filled in available fields that were sent to the backend database for eventual export. 75 respondents (25%) filled in the survey, with the rest stating that they did not send it in as no crime was experienced in the period under study 2000-2005.

**For want of a better data source...**

Crime data from newspapers was not availed of as generally short reports are given and mainly sensational, shocking and serious cases are given precedence such as homicides, rapes, hold-ups and molestation. Figure 6.1 depicts one report that made it to front page showing the persons convicted for murder and who are serving a life sentence. Figure 6.2 shows a sensational report of an attempted murder where two persons tried to kill each other, with the imagery showing an unorthodox elderly character made ‘famous’ by a previous murder and attempted murder as well as favoured by the media for his down-to-earth and colourful character.

*Figure 6.1: Convicted Homicide Offenders serving Life sentences  
Translation: Six serving life sentences in Corradino prison*



Source: In-Nazzjon, 13<sup>th</sup> February 2002, Front Page

*Figure 6.2: Sensational Reporting that may thwart scientific research due to its intrinsic nature  
Translation: Two men accused of attempting to kill each other*

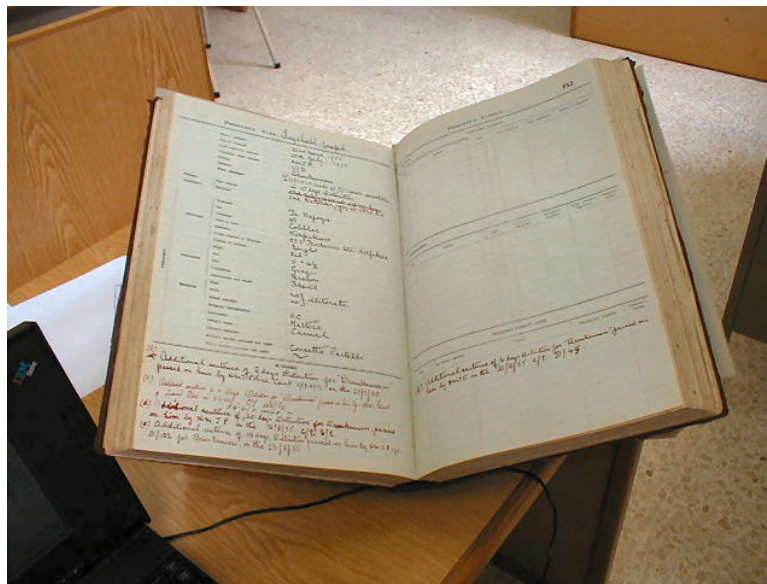


Source: L-Orizzont, 20<sup>th</sup> May 2003, Front Page

## 6.2.2 Data inputting, digitising and converting

The data inputting process was a tedious one, requiring various operational logistics. This process took place between 1997 and 2003 with new data delivered up to 2005. Data gathering from the convicted<sup>125</sup> prisons necessitated the use of manually inputting the individual offender and offence attribute data into a spreadsheet, each time necessitating checks to bring out the data from the prisons as a laptop was not allowed within the organisation<sup>126</sup>. In the case of the National Archives<sup>127</sup>, the process involved manually copying the ledgers and digitally inputting them in the spreadsheet once at home (Figure 6.3). This was mainly due to the researcher's lack of mobile laptop technology at the time until the later parts of the inputting phase. The whole process took so long that the media thought that the author was a permanent staff member at the Archives (Figure 6.4).

*Figure 6.3: Data inputting at the National Archives – a prison ledger of convicted persons*



<sup>125</sup> This first phase of the project took over 2,500 hours of data inputting and at least 150 hours for cleaning, verification, coding and reviewing.

<sup>126</sup> Solved by taking a desktop computer and 'sentencing' it for the duration.

<sup>127</sup> Santo Spirito Archives in Rabat Malta. This is the location of the non-active prison files, which were sent to the Archives for safe keeping since the documents were either at risk of deterioration from lack of adequate storage or from deliberate tearing of pages by persons accessing them inclusive of incarcerated persons.



Figure 6.4: Report depicting Crime Data Input as part of the Archives work



Source: L-Orizzont 8<sup>th</sup> August 2001: Pg 13

Also, data from the National Statistics Office (national crime data) was inputted as OCR technology is still not 100% reliable in the case of converting tabular data.

Where data was made available in paper map format such as a bus routes maps, this was manually digitised and saved directly in spatial format. Other data, where possible, was scanned, georeferenced<sup>128</sup> and digitised.

Where digital data was made available (refer to the metadata file in Appendix 4<sup>129</sup>), this was converted to the appropriate format and eventually to spatial format. In cases this necessitated conversion from textual to tabular to spatial formats in the process' full entirety. The textual to tabular conversion is necessitated to remove artefacts and align the data, whilst the tabular to spatial data is less strenuous except where geocoding issues are concerned as explained below.

### 6.2.3 Data cleaning and verification

Next to data inputting, data cleaning and verification is also a tedious phase of any research of this scope, where large datasets are involved. Whilst the manually inputted data were double

<sup>128</sup> Georeferencing is the process of placing an image onto an Earth projection through a number of referencing points on the Earth that correspond to those points on the image, normally represented by easily discernable topography and land cover such as monuments, natural land outcroppings, roads, etc. Once an image is georeferenced, any further overlaying misalignments can be adjusted through a rubber-sheeting process that helps stretch the image to form an acceptable overlay. The image is a raster and can be placed below a vector layer for ease of use in the rubber-sheeting process.

<sup>129</sup> Appendix 4 includes both digital and inputted analogue files.

checked during the inputting phase and validated through a series of SQL queries, the data sourced in digital formats necessitated another approach. This data was individually checked for inconsistencies, the major issue being street names errors (vital for geocoding purposes), missing data, and other inconsistencies.

This is a slow aspect of the project, particularly due to the numerous multiple-interpretation street names errors, alphanumeric errors in location names, offence information, as well as intentional errors by data-inputters<sup>130</sup>. This process entailed going through the whole list that did not match the official street names and interpret those same names and locations.

This process was repeated for the welfare data where correctness is even more vital due to the fact that persons receive benefits on a monthly basis and incorrect addresses mean non-issuing of cheques vital to such persons. In this case the issue was mainly identifying the local names of streets, multiple street names, alley-correction (integration of alley names with connecting street names) and other quality assurance measures.

In the case of available spatial layers, data cleaning was also necessitated due to the need to identify lacunae, overshoots, gaps, intersecting and overlaid polygons as well as missing data. This is important especially where Census data is involved due to the intersecting street centrelines and their subsequent polygon structure having a considerable part overlapping the corresponding street polygon. The resultant data can be misleading and depict an erroneous output leading to a wrong interpretation<sup>131</sup>.

#### 6.2.4 Geocoding procedures

Once the data was digitised, the next phase entailed the processing of all data to spatial format. This is possible through a process called geocoding where data in tabular format is given a spatial construct by assigning each data item some kind of spatial element<sup>132</sup>. In most cases this entailed assigning a point element such as a street centroid (central node) or assigned to a polygon such as an Enumeration Area or Local Council.

---

<sup>130</sup> These included genuine typos (such as Valletta written in over 25 versions, for example Valetta, Valleta, etc ) to near illiterate interpretations (such as Hookham Frere Street being written as Hook Ham Frier Street) to the downright witty and mischievous (such as an unknown tomb in the main cemetery written as Death Row, Addolorata Cemetery). Though eliciting a laugh the number of such errors meant time-wastage and necessitated individual record checking, reaching up to 99,575 for the Police reported crime dataset, with an average error adjustment in 40% of the streets.

<sup>131</sup> Mainly polygons covering intersecting polygons though not in any discernable priority.

<sup>132</sup> Spatial elements can be found in five entity constructs: Point – an x-y coordinate (example: a dwelling), Line – 2 points and an adjoining arc (example: a street centerline), Area or Polygon – an enclosed series of lines (example: a field), Network - a series of interconnected lines (example: a river), and Surface – a series of overlapping polygons (example: an island in a lake in a park).

This process is once again time-consuming and highly challenging, especially since no readily available software existed that could cater for the specific requirements of this study. Malta has no street-gazetteer, which is a data layer that would include street segments and dwelling numbers. The author sought to geocode a number of points along a street centreline when only the street address (with no address location given) was available. As at February 2005, no *mbx*<sup>133</sup> programme existed that automatically disperses a number of points randomly around a centerline, each having the same locational attribute (such as a street name). This induced the following process and rationale:

- a) creating a buffer around the street centrelines in order to prepare a series of polygons in which a number of points can be generated, which points would serve as anchors for the addresses (Figure 6.5);
- b) converting the buffers from a vector polygon to a raster grid file, which process actually creates a base of pixels for later conversion to the points described in a);
- c) converting the grid file to a series of points (Figure 6.6);
- d) processes a to c would have retained the attribute data, thus the next step is to clean and check the attribute generated in the raster-to-vector conversion. This was accomplished through a join with the centreline buffers through manual or automatic means (Figure 6.7);
- e) once each point was validated, a unique numbering system was created so that each point could be queried individually;
- f) cleaning the non-geocoded data (Figure 6.8);
- g) as not all street names were captured through this method, other technologies were used. These included on-line searches such as checking for missing data in MEPA's mapserver<sup>134</sup> and other on-line datasets (Figure 6.9);
- h) once the street-name validation was concluded, the next step sought to link the non-spatial data layers such as the police reported crime dataset to the unique points generated as per above process. This entailed the geocoding of the non-mapped layer into the dispersed points (refer to c) through a simple geocoding exercise following the insertion of the unique numbering system in the same dataset in line with e) (Figure 6.10);
- i) Overlaying the geocoded data onto other base data for verification purposes (Figure 6.11).

---

<sup>133</sup> MapInfo MapBasic script.

<sup>134</sup> <http://www.mepa.org.mt/Planning/index.htm?MapServer.htm&1>

Figure 6.5: Creating a buffer of 5metres for each street helped to develop a series of raster and vector maps that generated points for geocoding anchors

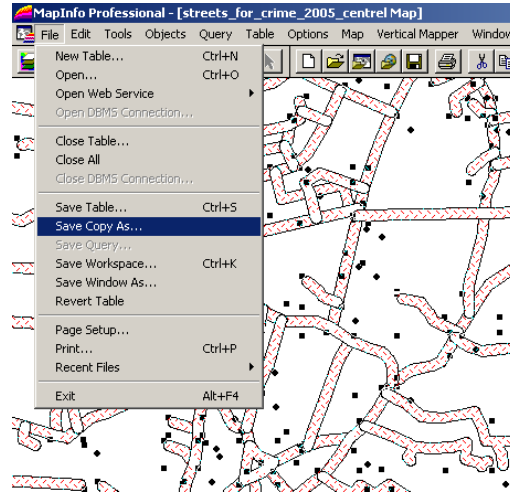


Figure 6.6: Rasterising the buffer points

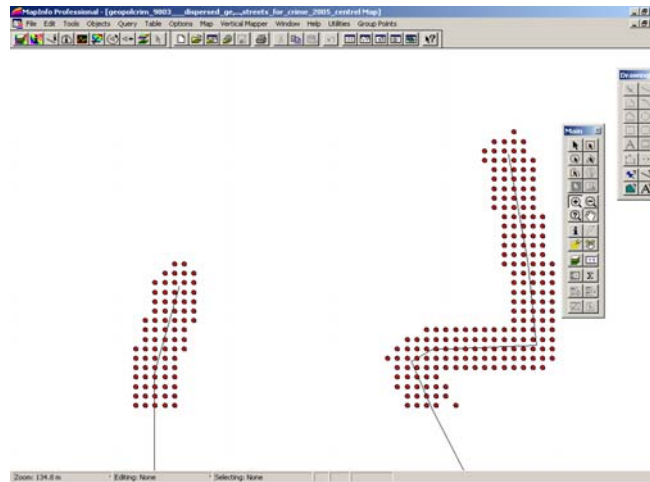


Figure 6.7: Checking attribute data for matching to centreline through manual or automatic means



Figure 6.8: Cleaning the tabular data prior to geocoding

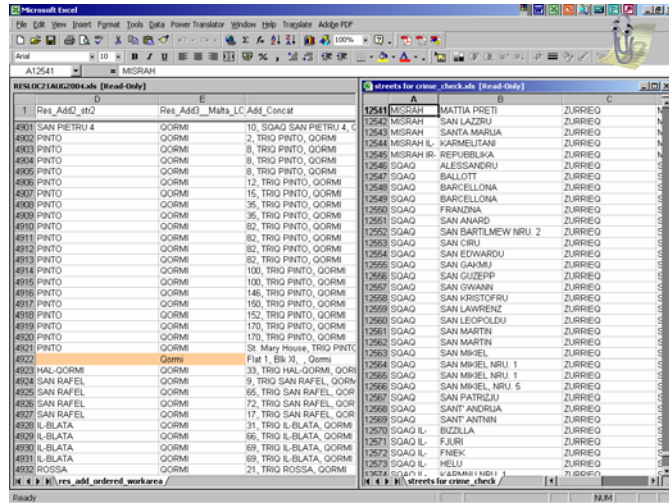


Figure 6.9: Checking for missing data in MEPA mapserver and on-line datasets

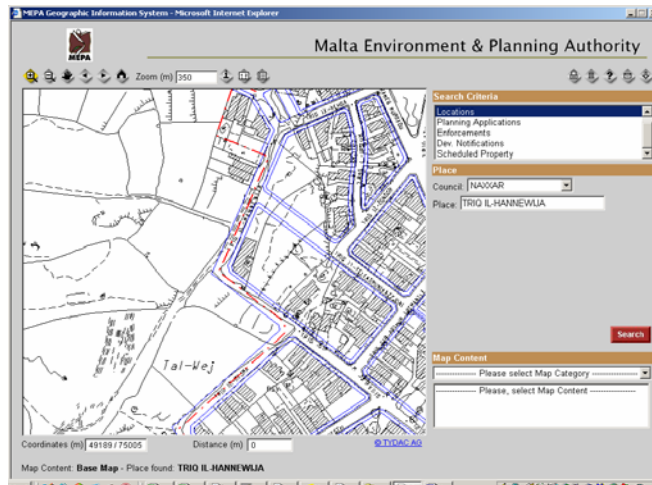


Figure 6.10: Geocoding the dataset based on dispersed points within the buffer

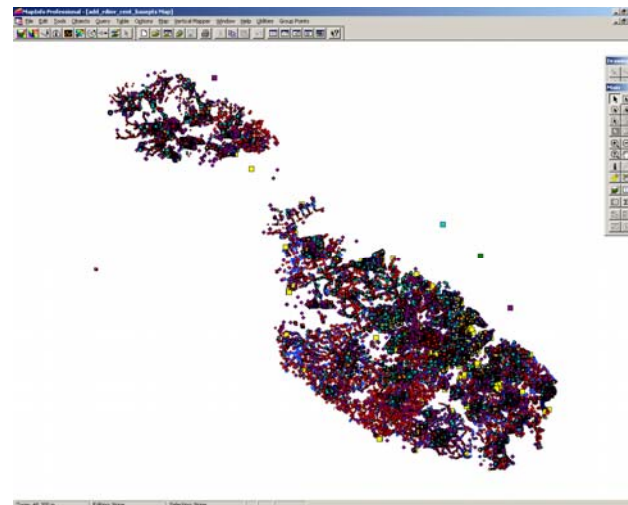
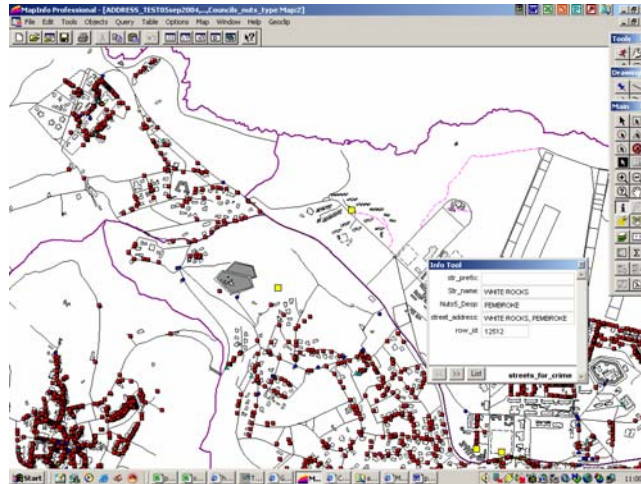


Figure 6.11: The final Result overlaid on other base data layers



A lineage<sup>135</sup> depicting the process undertaken to geocode a map was created, where a manual for the creation of such datasets was drafted. Appendix 5 lists a section from a sample lineage entitled “Geocoding crime data for the Maltese Islands”.

This process sought to investigate the possibility of preparing the base data for crime analysis in spatial format, as per objective 3 of this research. This target was reached through the process of geocoding and georeferencing crime, social and landuse data into spatial format and creating the first Maltese crime, social and landuse-related base-maps.

### 6.3 Data available for this study

The generic data categories were made available to the researcher as listed below:

- Offender data
- Offence data – related to CCF data
- Offence data - Police data (reported crimes)
- Education data (absenteeism)
- MEPA, MITTS data
- NSO (Census and Abstract of Statistics) data
- Welfare Data
- Landuse Data

The full list of datasets employed within this study is listed in Table 6.1. Appendix 4 lists the Metadata and describes the sample content of one dataset, listing coverage, currency, attributes,

<sup>135</sup> Recording procedure aimed at creating a manual of the process followed during the creation of the dataset.

format and status. All the datasets have been converted to spatial format except for the Abstract of Statistics data and the Household Travel Survey that was used for reference only and was not needed in the integration process for further analysis.

Table 6.1 lists all the datasets used, their time-period, the most detailed available spatial level and format. The crime data spans 50 years, the landuse data mainly relates to the late 1990s and early 2000s, the social data is mainly related to the 1990s with some 2000s data such as the welfare benefits dataset.

*Table 6.1: List of Datasets created through the research process*

<b>Dataset Topic</b>	<b>Time Period (Start - End)</b>	<b>Resolution</b>	<b>Format</b>
<b>Crime</b>			
Abstract of Statistics	1950 - 1999	National	Tabular
Convicted crime - offenders	1950 - 1999	Address	Spatial
Convicted crime - offences	1990 - 1999	Address	Spatial
Education - non-attendance court reports	2000 - 2001	Address	Spatial
Reported crimes to Police	1998 - 2003	Address	Spatial
Police Stations	2002	Address	Spatial

<b>Dataset Topic</b>	<b>Time Period (Start - End)</b>	<b>Resolution</b>	<b>Format</b>
<b>Socio-economic</b>			
Cemeteries	2003	polygons	Spatial
Clinics & Hospitals	2000	Address	Spatial
Electoral Register	2002	street	Spatial
Housing Estates and HOS	1980 - 1993	polygons	Spatial
Household Travel Survey	1999		Tabular
Libraries	2000	Address	Spatial
Schools	2000	Address	Spatial
Sports in Schools	2000	Address	Spatial
Census Population	1995	EAs	Spatial
Census household income	1995	EAs	Spatial
Census shared dwellings	1995	EAs	Spatial
Census ownership dwelling	1995	EAs	Spatial
Census persons per room	1995	EAs	Spatial
Census amenities	1995	EAs	Spatial
Census vehicles	1995	EAs	Spatial
Census children per household	1995	EAs	Spatial
Census citizenship	1995	EAs	Spatial
Census literacy	1995	EAs	Spatial
Census educational attainment	1995	EAs	Spatial
Census educational qualification	1995	EAs	Spatial
Census household unemployed children	1995	EAs	Spatial
Census economic activity by sex	1995	EAs	Spatial
Census occupation	1995	EAs	Spatial
Welfare Benefits	1995 - 2003	street	Spatial



Dataset Topic	Time Period (Start - End)	Resolution	Format
<b>Landuse</b>			
Basemap features	1988 - 2005	Point	Spatial
Address Point Database	1995	Address	Spatial
Bus Routes	2003	Buffer Polygons	Spatial
Road capacities	2000	street	Spatial
Development constraints - protected zones	2003	point and polygon	Spatial
Local Councils	2003	NUTS 5	Spatial
Development Zone	2000	point and polygon	Spatial
Enumeration Areas	1995	EAs	Spatial
Islands	1995 - 2005	NUTS 3	Spatial
Local Plan Areas	1990	NUTS 4 - equivalent	Spatial
Place Names	2003	NUTS 5	Spatial
Planning Applications	1993 - 2005	Address point and polygons	Spatial
Industrial Areas	2001	Address point and polygons	Spatial
Eateries	1999	Address	Spatial
Maltamal - dwelling vacancy and population	1996	street	Spatial
Planning area footprint	1993	point and polygon	Spatial
Retail units	1999	Address	Spatial
Road Inventory: includes street furniture	1993 - 1995	point	Spatial
Road system	2000	street	Spatial
Supermarkets	2001	Address	Spatial
Town Centres	1999	polygons	Spatial
Urban Conservation Areas and Village Cores	1994 - 2004	polygons	Spatial

### 6.3.1 Data Reliability

The main issue at stake that needs to be highlighted at this stage concerns the data currency that is employed throughout the study. As this is a first study of crime at high-detail in the Maltese Islands the source data is spread in many places, rarely accessible and disjointed. Every effort was taken to acquire as much data as possible pertaining to the period under study, though this was a major problem as little consistent data is available.

Harries (1974) identifies problems as regards to spatial analysis due to the fact that substantial spatial distortions can be found when analysis was carried out based on decennial censuses. If one uses the population of an area based on the census figures and then analyses crime for one year between the census periods using that same decennial data, the results would be erroneous – e.g. using 1993 crime data and compare it to the census population of 1985 and then to that of 1995. One would prefer to have the same years' data coverage, however this is only possible in an ideal world once all required datasets are acquired, converted to tabular format and subsequently geocoded. Only then can they be maintained and an annual update be created. That phase would then allow exact period analysis across all disciplines.



### 6.3.2 Aggregation levels of data available

Spatial data layers are aggregated in a number of levels that are primarily internationally recognised (such as NUTS nomenclature) or local boundaries specified by each entity requiring such an exercise. The main aggregation levels available in the Maltese Islands are listed in Table 6.2.

*Table 6.2: Spatial data Aggregations that have been used to analyse the research data*

<b>Spatial Aggregations</b>		
<b>Data Aggregate</b>	<b>Spatial data Model</b>	<b>Entities</b>
NUTS 1 2 (National)	Area	1
NUTS 3 (Islands (Malta and Gozo-Comino))	Area	2
NUTS 4 (Districts)	Area	6
NUTS 5 (Local Councils)	Area	68
EAS (Enumeration Areas – 150-180 households)	Area	1,157
LPA (Local Plan Areas)	Area	7
Police Regions	Area	2
Police Districts	Area	11
Police Divisions	Area	20
Health Centre Regions	Area	8
Rural (Out of Development Zone)	Area	3
Village Core / UCA (Urban conservation Areas)	Area	94
Dev Zone (Limits to Development Zone)	Area	129
Streets Combined	Line	7,565
Streets	Line	13,098
Address Points	Point	199,694

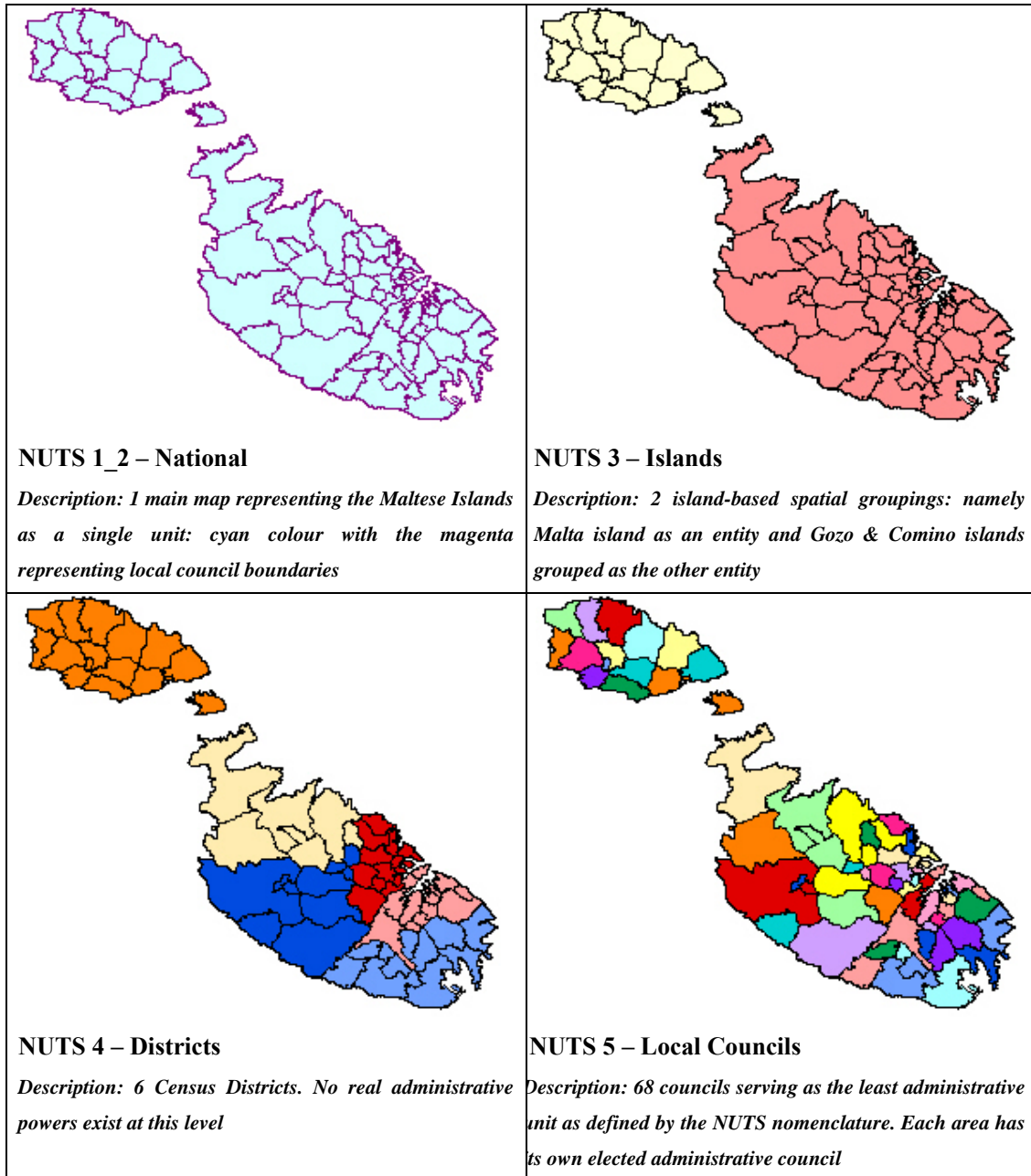
Very few organisations follow NUTS districting, having predated it. Usage of the aggregate layers from different entities posed new problems in analysis: in fact it seems that each organisation made it a point to be different, using different aggregations based on operational logic. This said, the police are looking at using the NUTS nomenclature as the basis for districting. Figure 6.12 outlines a set of maps that show the main aggregate layers as outlined in Table 6.2, which maps should serve as an eye opener to the constraints placed upon researchers when analysing spatial data.


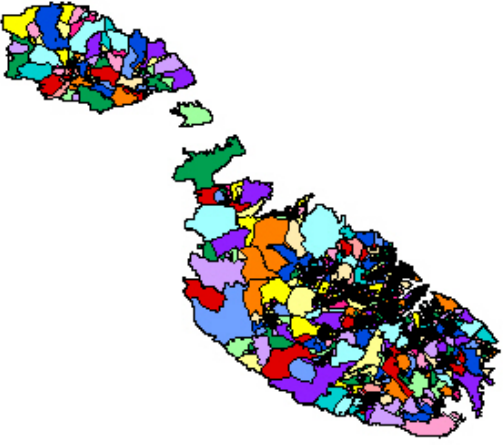
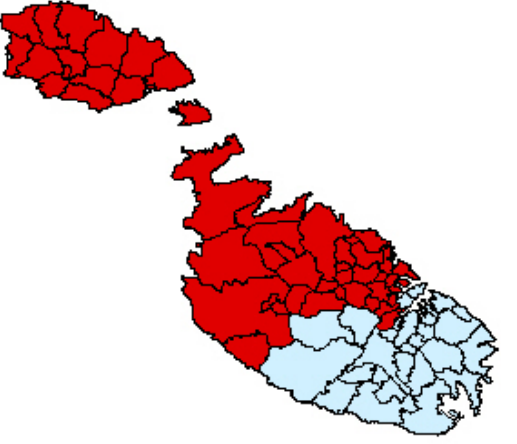
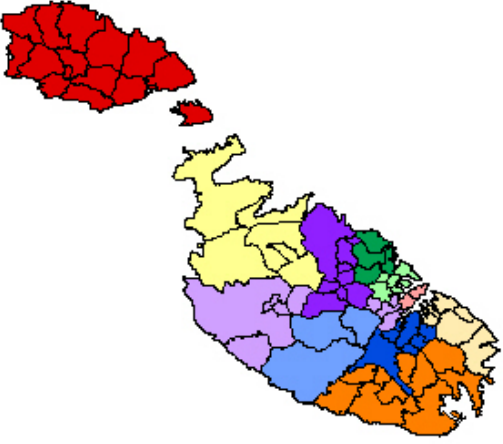
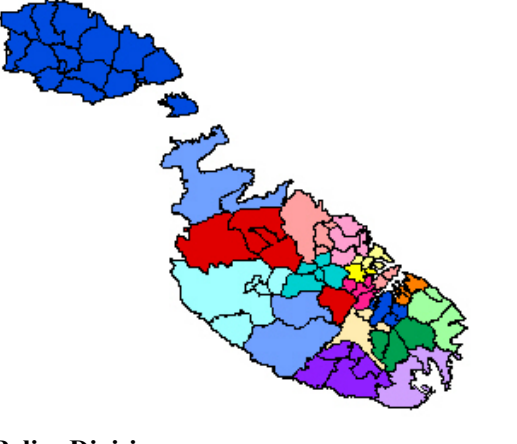
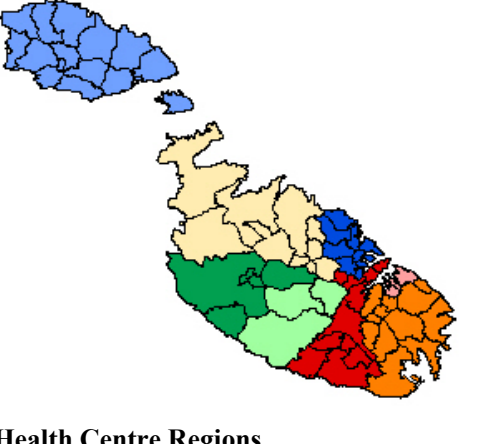
This issue was solved through the generation of data at the highest detail possible: at street level. This allows any researcher to build up rather than using the top-down approach that hinders analysis once an aggregate cannot be split up further into its component parts due to lack of data at that high-detail level. Thus, from basic street data, the different organisational districts (such as police or health) can be catered for.

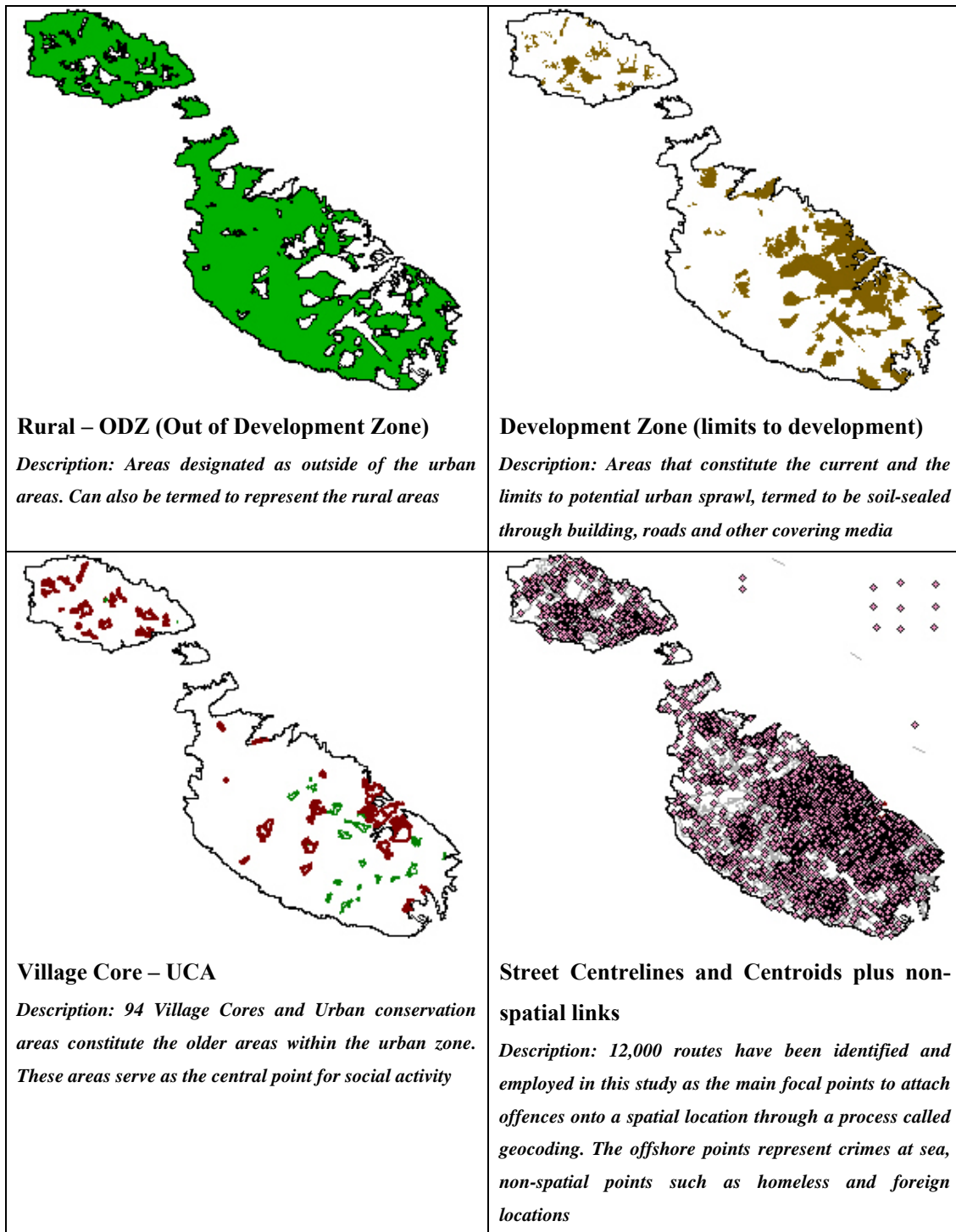
At the social level, data on welfare was provided at street level, and Census data at Enumeration Areas (EAs) level, thus this ensured that the real highest-detail level of analysis is the EAs. This implies aggregating data one level up from address-point or streets to EAs level.

Figure 6.12: Map Data Aggregations

(spatial area grouping as delineated by different agencies: colours represent individual areas under the different categorisations)



 <p><b>MEPA Local Plan Areas</b></p> <p><i>Description: 7 areas as outlined for development planning based on landuse classification. Boundaries cross over between local council boundaries</i></p>	 <p><b>Enumeration Areas</b></p> <p><i>Description: 1157 Census-based enumeration areas based on the boundaries set for each enumerator nominally representing 150 households.</i></p>
 <p><b>Police Regions</b></p> <p><i>Description: main police regions dividing the Islands in two main areas</i></p>	 <p><b>Police Districts</b></p> <p><i>Description: 11 districts depicting the main administrative police areas</i></p>
 <p><b>Police Divisions</b></p> <p><i>Description: 20 divisions signifying areas of specific policing requirements</i></p>	 <p><b>Health Centre Regions</b></p> <p><i>Description: 8 health regions supplying a central polyclinic that caters for residents falling within their boundaries</i></p>



#### 6.4 Data analysis

Data analysis was carried out on diverse levels, though mainly concentrating on the analytical methods, statistical measures and spatial statistics. Different types of methods and statistics as employed in crime studies are available for both tabular and spatial analysis. GIS has also enabled a variety of analyses to be conducted as listed in the examples below (CMAP, 2002):

- Offender/Victim Movement analysis – monitoring the travel patterns of offenders and victims
- Temporal analysis – analysing crime over time (yearly, etc) and at different time periods
- Environmental analysis – analysing the location of offences and offenders
- Property analysis – analysing the risk of crime by property type
- Link analysis (criminal relationships) – analysing the relationships between offenders and groups prone to offend
- Victim/Target Characteristic analysis – monitoring the interactions of offenders and victims in their routine activities
- Causal analysis – analysing the cause and effect of offence and offenders on the physical and social fabric

These methods require statistical tests to enable analysis and such software as CrimeStat aid in the analytical process prior to the crime-mapping analysis through a dedicated GIS application.

As an example of types of spatial statistics used in Crime, listed below are the CrimeStat categories clustered in four-groups<sup>136</sup>: Spatial distribution, Distance statistics, ‘Hot spot’ analysis routines and, Interpolation statistics:

1. Spatial distribution - the mean center, center of minimum distance, standard deviational ellipse, Moran’s I spatial autocorrelation index, or angular mean;
2. Distance statistics - nearest neighbour analysis, linear nearest neighbour analysis, and Ripley’s K statistic;
3. ‘Hot spot’ analysis routines - hierarchical nearest neighbour clustering, K-means clustering and local Moran statistics;
4. Interpolation statistics - a single-variable kernel density estimation routine for producing a surface or contour estimate of the density of incidents (e.g. auto thefts) and a dual-variable kernel density estimation routine for comparing the density of incidents to the density of an underlying baseline (e.g., auto thefts relative to the number of households).

This study employs a variety of these methods, particularly Moran’s I, hot spot and interpolation. It also bases its procedures on the following methods.

- i) One of the best methods of analysing crime patterns is to use clustering methodology. Due to the large number of crimes occurring in a particular area, analysis may concentrate on the

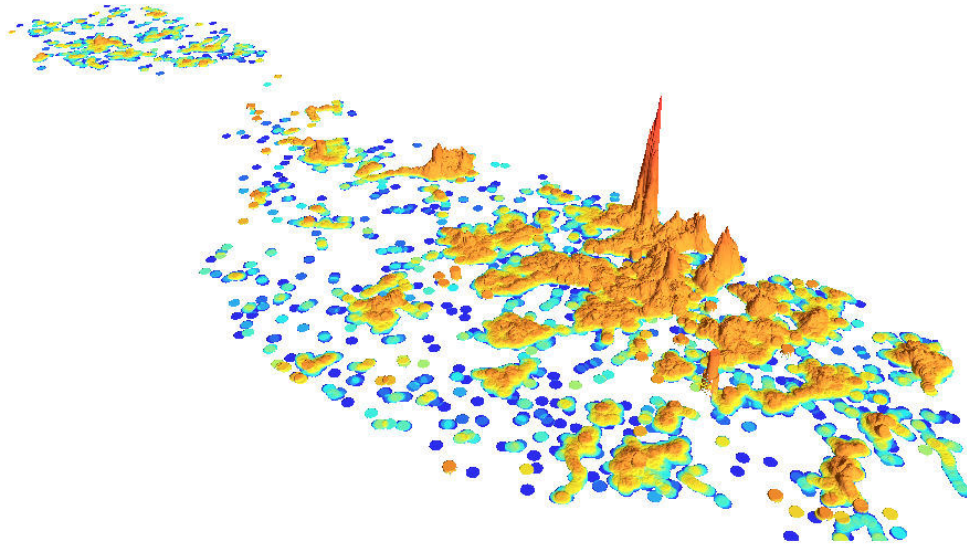
---

<sup>136</sup> <http://comm-org.utoledo.edu/pipermail/announce/1999-December/000025.html>

aggregation of these data into specific areas rather than spread them all over the town. Clustering helps in identifying areas that are hotspots for specific crime types;

ii) Another method that can be employed is the Nearest Neighbour Analysis (NNA) which helps to aggregate data based on the proximity of a crime to the nearest location of another crime (Craglia *et al*, 2000). If a crime occurs within a specific parameter of say ‘20m’ from that being analysed, then these two crimes are aggregated, before searching for other crime/s within the next specific boundary<sup>137</sup>. Once there are no crimes left within the recurrent buffers then the hotspot intensity dies out and stops. Where a large number of crimes occur in a small area the hotspot is very pronounced and cluster densities can be calculated. Figure 6.13 depicts an example of such an NNA interpolation based on non-serious offences in Malta between 1998-2003 transposed in 3D. The shape of the Maltese Islands is easily discernable, particularly the conurbation area. High offence counts are depicted as with red peaks in the main leisure and recreation areas and very few if anything in the rural and rural-urban boundary areas (blue and white respectively). The same methodology can be used to elicit statistical results as well as for visualization purposes.

*Figure 6.13: Interpolation of Non-Serious Offences – 1998-2003*



Source: The Author

Note that each of these methods necessitates knowledge of the limitations in using that specific method which limitations are dependent on a number of factors. These include

---

<sup>137</sup> Note that variance in the boundary width can produce different results.

the sample size taken, the number of minimal points set as the threshold for identifying the least hotspot size, amongst others. The limitations of the methodologies used such as the NNH include differing hotspot locations for different spatial aggregations employed, such as a minimal 25-point hotspot cutoff, which signifies where an ellipse boundary should be drawn once no more points falling within those thresholds are encountered. Consistency in the results is ensured as the analysis in this study employ the same threshold limits. Another limitation relates to the issue of cross-comparison of two data-layers that may have widely-differing counts, such as a 10,000 point offender data layer and a 1,000 point poverty layer. Using the same standard-deviation levels and thresholds, error generation can be reduced to a minimum.

In addition, NNH as well-as K-Means employed in the study show their results through ellipsoids, which in effect can cover areas that may not be prone to high incidences being investigated but still fall within the ellipsoid since such a tool cannot eliminate areas within its boundary without compromising the ellipsoid integrity. Also, some ellipsoids might show areas that have high concentrations of incidences when the base data might show few data points, which result is mainly due to a multiplicity of overlapping points found within the base data layer and weighted for in the ellipsoid. Knowledge of the base data layer is required in order to interpret the results of such methodologies.

The issue of boundaries designation is highly sensitive in that the decision taken on which area level for analysis can result in arbitrary effects particularly since the same spatial entities under study may create ambiguous results where the bounds are not clear or where one could have ambiguous transition zones as well as generating some boundaries that ignore the interaction between the activities within that boundary and those external to it. Such results may give an indication that only those areas within the resultant boundaries show incidences of clustering. This issue can be solved through the employment of sensitivity analysis strategies such as those posited by the Modifiable Areal Unit Problem (MAUP). This process analyses the limits of each study level and compares the results emanating from each analysis run, varying by both MAUP components: the scale problem and the zoning problem. ONS (2007) state that “*the scale problem refers to the variation in numerical results that is strictly due to the number of areal units used for the analysis of a given territory (i.e. the level of spatial resolution). The zoning problem arises because of the large number of possible ways of partitioning*

*a study area into a given set of areal units, and the fact that how such a partition is configured may impact on the results of analysis<sup>138</sup>.*”

In addition, there are other methodologies that may have given differing results should they have been employed in this study. These include the alternative measures of hotspot analysis for example Kernel Density Estimate, Getis-Ord GI\* and also multiple regression as an alternative to bi-variate analysis.

- a) Kernel Density Estimate can be employed to estimate the probability density function of a random variable such as offence location. Employing kernel density estimation on a sample population helps researchers to extrapolate the data to the entire population (Wasserman, 2005) .
- b) The Getis-Ord GI\* statistic is based on an analysis of weighted data points and identifies those clusters of points with values higher in magnitude than one might expect to find, with an output based on a z score for each feature, which represents the statistical significance of clustering for a specified distance employing either Euclidean or Manhattan distance. Getis-Ord GI\* high z scores indicate its neighbors have high attribute values, and vice versa. The higher (or lower) the z score, the stronger the association.
- c) Multiple-regression could also have been used in this research once the uni-variate and bi-variate analysis were completed, however this was not taken up for reasons for time and space constraints impinging on the research. Multi-variate analysis helps one to examine more than one predictor of an identified variable. It is highly relevant to social sciences due to its inclusion of a number of predictor variables which enable higher levels of prediction of the outcome variable.

Each of the above methods have been earmarked for post-study research, particularly as a comparative analysis of the results emanating from the methods used in the analytical chapters.

These methods of analysis can also help researchers to use geodemographics and other social data to analyse crime and the potential target areas. Use of transport and retail GIS can help to identify areas that have a high concentration of retail and travel activity that would attract ‘predators’. In this scenario, GIS can help to identify the high traffic-volume streets together with the potential areas where retail is highly concentrated and would serve as an attractor for criminal

---

<sup>138</sup> ONS, 2007: The modifiable areal unit problem: impact on official statistics:  
<http://www.esrcsocietytoday.ac.uk/ESRCInfoCentre/opportunities/>



elements. Together with other data such as Census data, one can predict users of a service and the potentiality for crime to occur (Cairns, 1998).

## 6.5 Analysis techniques

The main aim of this structural process is to elicit relationships between the different datasets in the three main themes of crime, social and landuse disciplines. Both are covered by the methodology employed in this study.

Bottoms and Wiles (1997) identify two key methodological issues that need to be addressed in a criminological study that are useful to this study that looks at crime rates:

- i. The offender rate and offence rate distinction. This distinction is needed especially in the designation of land-use status for particular areas which may give a high correlation between offender and offence rates if industrial and city centre zones are excluded from the study (Mawby, 1979 IN Bottoms and Wiles, 1997). The researcher must be aware of the distinction between offence rate and victimisation rate. Offence rates cover all crime occurring in a particular area irrespective of who the target is or their origin, whilst victimisation rates cover only those persons who live in a particular area and have been victimised in any place even beyond their residence boundaries. The study must clarify which rate shall be used especially where the data sources are not clear. Police crime data fall under the offence rate, whilst victim surveys fall under the victimisation rate studies. The study uses the former.
- ii. Validity of the official criminal statistics in relation to area-based data. The problems of recording practices and public crime-reporting can vary across districts.

Crime counts in themselves have little meaning if they are not compared to other factors through cross-sectional and longitudinal analysis. This is where crime rates are introduced, such as the analysis of crime against density or proximity to a specific target such as high-income housing. Hyatt *et al* (1999) differentiate between crime counts and crime rate. Crime counts are absolute figures of crime incidence by type, total, etc, whilst rates are given as the proportion of crime counts per population (1,000) count:

$$\text{crime rate} = \frac{\text{crime count}}{\text{population}} \times 1000$$

This method is used throughout this analysis as it places small and large countries on the same footing.

Boggs (1965 IN Beavon *et al*, 1994) stated that crime-rate ratios based on simple resident population denominators can produce distorted pictures of crime distribution. They should be based on the risk or target group appropriate to the specific crime category. This may be difficult to compute but would make sense even more so where areas attract persons for some type of commercial or other reason, especially where recreation and tourism services such as bars are offered (Schwaner, 2000). One could take the case San Giljan in Malta which is a recreational town. The town ranks as the highest offence rate area in Malta but residents are few in number and most crime is related to thefts of and from vehicles). Thus this study looks at offences against the landuse zoning rather than against the population that resides there. Offender data analysis however, does take the residential aspect into account.

In a review of offender and offence ratios analysis: Beavon *et al* (1994: 142), state that a Pareto function model of distance decay can be used to analyse the simple distribution of offences in relation to the location of an offender's home. Chapter 8 of this study uses a Euclidian distance analysis based on spider-graphing methods.

An interesting analysis on risk assessment (Craglia *et al*, 2000: 720) looked at estimating the potential of an area to host crime. The researchers based their methodologies on epidemiological and demographic studies and produced a method that can give a clear picture of crime risk in small areas. This method can be extrapolated in the analysis of deprivation. As an example, Standard Burglary Rates (SBR) were established, which indicated whether an area has a high risk of being burgled. The steps (Figure 6.14) they used were based on the calculation of the national burglary rate per household and the resultant SBR was calculated for each Enumeration District (ED) which was the smallest spatial aggregation entity available. This result gave the expected number of burglaries in an area, which was then compared with the observed number of burglaries. The result of the latter analysis would give an indication if an area is at high risk where the figure (for each ED) is greater than 100.

Figures 6.14: Formulas for the calculation of Risk of Being Burgled

Step 1: Calculating the Standard Burglary Rate

$$\text{Standard Burglary Rate (SBR)} = \frac{\text{Nationwide burglaries}}{\text{No. of Households}}$$

Step 2: Calculating the Expected Crimes in Enumeration Districts

$$\text{Expected No. of Burglaries (EB) for each Enumeration District (ED)} = \text{SBR} \times \text{No. of Households in each ED}$$

Step 3: Calculating the Risk of Being Burgled for each Enumeration Districts

$$\text{Risk for each ED} = \frac{\text{Observed Crime (OB)}}{\text{Expected Crime (EB)}} \times 100$$

Source: Craglia *et al*, 2000: 722

This methodology was used for this study since it allowed the analysis of national to small area comparisons across the CRISOLA parameters. The method employed reviewed the correlations between different variables based on this method. Basically each variable's result was converted to ordinal groupings of 'less than 100', '101 to 500', '501 to 1000' and '1000 plus', where 100 represents the national rates. Each of these results was correlated against those of other variables for their relative strengths.

## 6.6 Outputs

In effect, the study brings spatial statistics into social research where statistics is not yet considered the mainstay for scientific analysis in the local scene, and the spatial dimension may yet prove the jolting kick to make researchers aware of the potential of visual statistics. The study creates its own crime-specific spatial maps, crime-landuse analytical maps as well as crime-social analytical maps and statistics based on a GIS analysis. Another output will be the development of a map of poverty in Malta at a detailed level (EAs) based on Census data that is integrated in the model to form a part of the crime-socio-economic analysis. The analytical process can eventually help develop a tool that enables crime-social analysis through the

integration of the relevant datasets within an integrated information system. A final output is concerned with dissemination was the Malta Crime Web-Map described in Chapter 4.

## 6.7 Summary

The methodology used in this study relies heavily on the quantitative aspect, particularly due to its stress on the spatial factor. The data design process highlighted the dearth of data available and the long-winded process it entailed to produce a spatial construct for this research study.

A review of the local data situation was given. The available datasets being analysed show that there is a need to analyse the data in line with an analysis of the interaction between all three CRISOLA themes: crime, social and landuse. A data reliability issue was also covered. A description of the spatial data aggregation levels was given with a depiction of each of the levels available for study and within which the datasets employed in the study have been configured. The chapter reviewed the available datasets, their structures and paved the way for the analysis chapters through a description of the statistical measures available for spatial analysis.

This done, the next chapter initiates the analysis function of the study, with an analysis of the Malta-in-Europe and Malta-and-Islands perspectives, followed by a review of crime in Malta over the decades. The latter sets the scene for the more detailed analytical chapters of spatial crime analysis at offender and offence levels.

## **Chapter 7: Crime Analysis: Malta in an International Perspective and Generic Analysis 1950-1999**

### **Introduction**

The chapter analyses Malta's crime situation at national and international levels. Initially, it takes a national level analysis, where the study analysis crime-related statistics dedicated exclusively to local crime reporting. The latter takes a temporal approach as it analyses a 50-year record study of crime-related statistics taking the period 1950 to 1999 as its base. The second part attempts to establish Malta's 'position in the world of crime'. It reviews crime levels in Malta as against those of other countries, taking a dual level perspective: the macro (European) and micro (small islands) perspectives. This approach elicits Malta's ranking in an international construct and through clustering identifies the Islands' position. Based on the results, a safety-dangerousness model is created placing Malta's position on that scale.

Note that the term macro and micro were employed in this chapter to denote an issue of relative scale between the European (continental) and small islands comparison. The European analysis was termed macro as it covered a larger geographic area than the smaller and in turn relatively microscopic island areas. Micro does not allude to point-sized definitions used elsewhere in this study, which are analysed for their spatial constructs within the Maltese islands, for example a point would be termed micro as against a large island polygon which would be termed macro.

Note that the international data is based on the United Nations, (2003), *InstrumentE, Questionnaire for the Seventh United Nations Survey of Crime Trends and Operations of Criminal Justice Systems* where each country completed the survey based on a series of definitions and composition for each crime type (as outlined in Appendix 6), the comparability of these results is based on that international survey. The only issue that needs to be highlighted concerns the dark figure of crime within each reporting country which can vary considerable by country or group of countries; such as the 37% of violent crime as reported in Western Europe and 24% in Eastern Europe as against 65% and 44% respectively for property crime and 50% and 33% respectively for other crime (Alvazzi del Frate et al, 2004; Van Kesteren, J.N. et al, 2000). The British Crime Survey also reports that out of 11 million offences in 1981 less than 3 million were reported; as against 11m and 5.6m respectively for 2005/2006 (Jansson, 2007) . Until such time as new international research figures on 'detailed' levels of non-reporting are made available, the figures as reported to the UN are analysed. Should new data be made available the results might show differing comparability outputs and hence would require updating. The base United Nations data employed for this study states that by definition "crime statistics are often

better indicators of prevalence of law enforcement and willingness to report crime, than actual prevalence".<sup>139</sup> In view of this, the figures resulting in this chapter for this Malta-comparative study should be reviewed against this state of affairs in data availability.

## **7.1 Offences in Malta - a 40 year perspective of crimes known to the police**

The next section attempts a focus on local national crime in order to present a historical account of crime in the Maltese Islands. It looks at the statistics of crime in Malta over the 40-year period from 1960 to 1999 (as data for the 50s was not available for this section) and reviews changes that occurred in the main crime reporting categories. Data is extracted from the Abstract of Statistics<sup>140</sup> as published by the National Statistics Office. Data for 1998 and later is not available in the Abstracts and where possible is inserted from the official Police crime dataset.

Due to the large number of tables generated during the course of this analysis, the main count tables were extracted to Appendix 7 and the percentage tables were left in this section. Refer to Appendix 7 for the full relative set of tables and figures.

Crimes in the Maltese Islands are reported to the Police, and are subsequently inputted into a PIRS system. However this system was launched in 1997 and a new classification was also launched at the time. In effect analysing crime data in the Maltese islands over time has proved problematic with the main crime categories not necessarily providing continuation over time. Due to this classification misalignment, data pre-July 1997 is analysed in isolation to data post-August 1997. The first part of this chapter tackles the following research questions within the two periods of data gathering as described in 7.1.1 and 7.1.2.

*Research Question: Have crime rates increased over time?*

*Research Question: Are serious crime rates very low in Malta?*

### **7.1.1 Type of Offence: 1960-1997 (July)**

The early decades' crime analysis shows an increase across all offences from 9.7 per 1000 persons in the 1960s to 25.2 in the 1990s.

---

<sup>139</sup> <http://www.uncjin.org/Statistics/statistics.html>

<sup>140</sup> Dataset was created through manual inputting of all the data pages for the 50-year period.

Crimes during the 1956-1997 period indicate a high component of theft from vehicles (29.3%) and from urban property (23.4%). A crimes per 1000 persons analysis (Table 7.1 and Figure 7.1) for vehicle crime indicates that these figures increased from 2.0 to 5.9 from the 1960s to the 1990s. In effect this indicates a quadrupling of vehicle-related crimes. Theft from urban property also indicates a major increase from 0.9 crimes per 1000 to 4.6 from the 1960s to the 1990s – an increase of 5 times the 1960s figure.

Table 7.1: Type of Offence - 1000 persons: 1950-1997 (July)

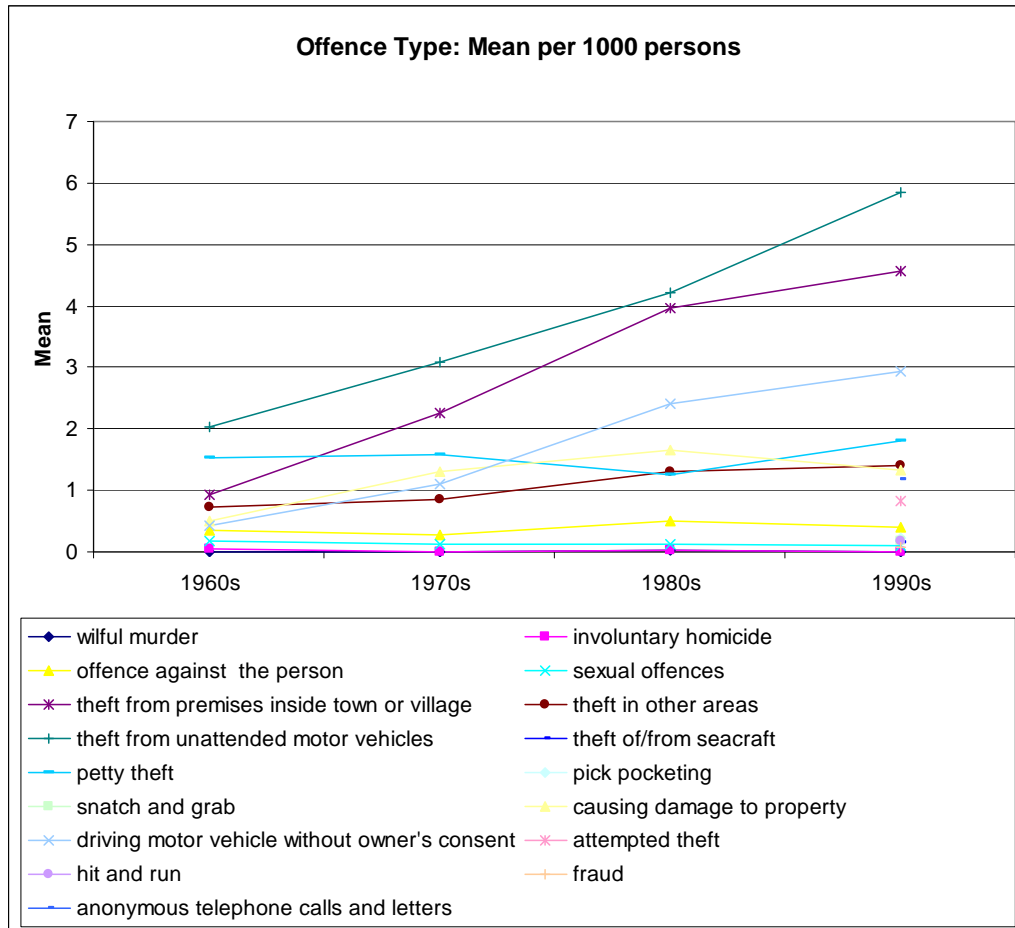
Type of Offence (Mean per 1000)																		
Absolute Figures	ALL CRIMES	wilful murder	involuntary homicide	offence against the person	sexual offences	theft from premises inside town or village	theft in other areas	theft from unattended motor vehicles	theft of/from seacraft	petty theft	pick pocketing	snatch and grab	causing damage to property	driving motor vehicle without owner's consent	attempted theft	hit and run	fraud	anonymous telephone calls and letters
1960s	9.7	0.0	0.04	0.3	0.2	0.9	0.7	2.0		1.5			0.5	0.4				
1970s	11.5	0.0	0.01	0.3	0.1	2.2	0.8	3.1		1.6			1.3	1.1				
1980s	15.5	0.0	0.03	0.5	0.1	4.0	1.3	4.2		1.2			1.7	2.4				
1990s	25.2	0.0	0.00	0.4	0.1	4.6	1.4	5.9	0.2	1.8	0.2	0.2	1.3	2.9	0.8	0.2	0.1	1.2

Note: data for 1965-1997 July available

Note that such figures are bound to reflect changes in the number of potential targets over time such as higher affluence, more vehicles around and more property to steal in domestic burglaries. This issue can be further investigated in future research.

Wilful murder remained constant from the 1970s to the 1990s, having increased slightly from 1960 from 0 to 0.01 per 1000. Inversely other serious crimes decreased when analysed in a crimes per 1000 context; involuntary homicide (0.04 to 0), and sexual offences (0.2 to 0.1).

Figure 7.1: Type of Offence - 1000 persons: 1960-1997 (July)



### 7.1.2 Crimes post-1997 per 1000 persons

An analysis of crimes post-1997 shows a major jump in all offences (grand total) from 25.2 per 1000 in the 1990s to an average of 43.8 during the first five years of 2000s (from 53.51 in 2000 to 45.82 in 2005). The absolute number also shows a major change in crime component: increasing from just under 15,000 for the whole 1960s decade to over 18,000 in 2005 only.

As indicated in the 1950-1997 period, the high theft component reached 28.11 per 1000 persons in 2005 (Table 7.2). The data also shows a relatively high rate of damage-related crimes up to 9.09 per 1000 in 2005.



Table 7.2: Type of Offence - 1000 persons: 1997 (Aug) - 2005

Type of offence	Aug - Dec 1997	1998	1999	2000	2001	2002	2003	2004	2005
All crimes Absolute	6,170	15,771	16,046	17,030	15,912	17,043	17,773	18,388	18,579
All crimes per 1000	16.06	40.82	41.27	43.51	40.32	42.90	44.44	45.66	45.82
Abuse of public authority	0.01	0.01		0.01	0.01	0.00	0.00	0.01	
Against morals/honour -family	0.08	0.17	0.13	0.10	0.08	0.10	0.07	0.09	0.07
Arson	0.09	0.27	0.37	0.27	0.24	0.23	0.30	0.30	0.31
Attempted offences	0.55	3.43	2.34	2.83	2.61	3.29	3.37	3.13	3.40
Bodily harm	0.73	1.44	1.70	1.91	1.89	2.07	2.50	2.64	2.69
Computer misuse						0.01	0.01	0.03	0.03
Crimes against public peace	0.05	0.04	0.01	0.02	0.03	0.01	0.01	0.00	
Crimes against public safety	0.03	0.03	0.02	0.03	0.02	0.01	0.01	0.00	0.00
Crimes against religious sentiment		0.01	0.00	0.00	0.01		0.01		0.00
Crimes against the administration of justice etc		0.00	0.04	0.03	0.02	0.03	0.01	0.01	0.02
Damage	4.99	11.99	10.90	9.47	8.66	8.71	8.94	9.08	9.09
Drugs	0.08	0.11	0.17	0.14	0.14	0.13	0.12	0.19	0.28
Forgery	0.02	0.04	0.09	0.11	0.09	0.09	0.05	0.23	0.14
Fraud	0.10	0.31	0.49	0.52	0.31	0.35	0.36	0.40	0.44
Homicide	0.00	0.01	0.02	0.01	0.01	0.01		0.02	0.01
Immigration	0.08	0.22	0.30	0.35	0.44	0.47	0.34	0.31	0.47
Infanticide/abandonment of child	0.00		0.01	0.01	0.01	0.01	0.01	0.01	0.00
Perjury & false swearing		0.01	0.02	0.01	0.00	0.01	0.02	0.00	0.00
Prostitution	0.00	0.03	0.07	0.06	0.04	0.06	0.02	0.04	0.11
Sexual offence	0.08	0.14	0.17	0.14	0.11	0.13	0.19	0.15	0.18
Theft	8.69	21.00	23.63	26.76	24.90	26.47	27.57	28.47	28.11
Threats and private violence	0.42	1.20	0.62	0.47	0.50	0.40	0.28	0.26	0.21
Trafficking of persons									0.00
Violation of places of confinement		0.01	0.01	0.01	0.01	0.01	0.02	0.01	0.02
Violence against public officer	0.07	0.32	0.16	0.25	0.21	0.28	0.26	0.28	0.23

Bodily harm also grew from 1.44 in 1998 to 2.69 in 2005 with drugs going from 0.11 in 1998 to 0.28 in 2005. Whilst these serious crimes show a high level of increase in real terms, the rest of the crimes do not have such drastic increases but tend to be consistent such as abuse of public authority, arson, homicide, infanticide/abandonment of child and sexual offences. Some crimes such as threats and public violence experienced a decrease. Interestingly new crimes have been introduced during the first few years of the 2000s. These include trafficking of persons and computer misuse, each reflecting emergent offences related to new social and technological realities, amongst them the issue of illegal migration and on-line crime opportunities.

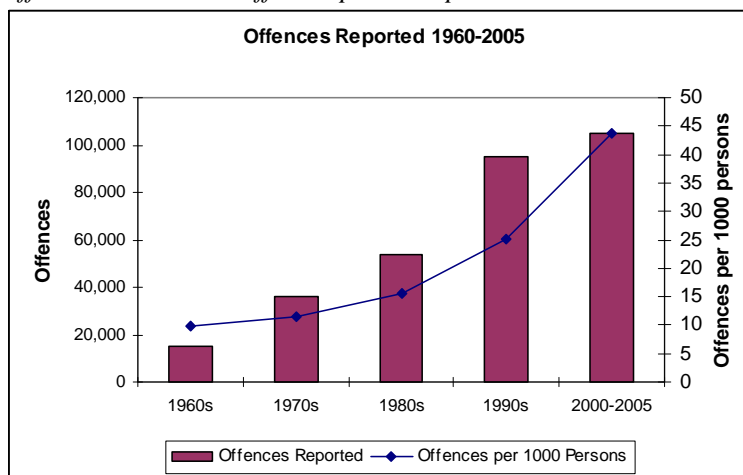
Finally, a 50-year offence reporting analysis (Table 7.3 and Figure 7.2) shows that there is an increasing trend that is consistently growing and may appear to be exponential, increasing from 14,881 offences in the 1960s to 95,180 in the 1990s and 104,752 in the first 5 years of the 2000s. Crimes increased by 144% from the 1960s to the 1970s, then again by 47% in the 1970s-1980s period and by a further 78% in the 1980s-1990s period. The first major jump in crime numbers

was experienced in the 1960s that is also reflected in the number of cases introduced between the 1950s to 1960s where Courts caseload jumped from 12,140 in the 1950s to 163,111 in the 1960s: a 1243% increase as against 31% for the next decade, against a decline of 25% in the 1970s-1980s period (that also saw a turbulent period for Court administration) and an increase of 23% in the 1980s to 1990s. The massive increase during the first decade indicates some kind of trigger in crime reporting: this could be linked to economic improvement, more efficient policing systems; a situation that recommends further future research.

*Table 7.3: Offences Counts and Offences per 1000 persons: 1960s to 2005*

Year	Offences Reported	Offences per 1000 Persons	Maltese Population
1960s	14,881	9.7	316,440 (1965)
1970s	36,372	11.5	306,551 (1975)
1980s	53,465	15.5	340,907 (1985)
1990s	95,180	25.2	378,404 (1995)
2000-2005	104,725	43.8	391,295 (2005)

*Figure 7.2: Offences Counts and Offences per 1000 persons: 1960s to 2005*



### 7.1.3 Summary

In summary, crimes per 1000 have grown from 9.7 in the 1960s to 25.2 offences per 1000 persons in the 1990s with new 2000-2005 data indicating a further increase to 43.5 per 1000. Such figures indicate a dynamic offence situation in the Maltese islands that has not seen any decrease in offences, in fact the opposite is evidenced year by year at steadily increasing crime rates being reported.

## 7.2 Malta in the Wider World

Where does Malta fit in an international crime league-table? Is the island state a high-crime area or is it a safe destination? These are the usual questions targeted at any state but Malta's dependence on a tourism-based economy highlights the need to know more about the islands. Whilst it is stated that Malta is a safe country, there are few statistics to prove this<sup>141</sup>.

*Research Question: What is Malta's relative crime position as compared to i) European countries and ii) other small island states around the world?*

This section aims to look at Malta from a European perspective, against the worst and best countries, at a generic level (all crimes) and at specific crimes level (individual). Malta has recently joined the EU and little comparative analysis involving Malta has been carried out on this topic. Finally, the study takes a different perspective, one that would do justice to the Maltese image and position in the wider world: the Island perspective. Though Malta plays a "big boys" game at international level with UN and EU membership, it is a micro-state with its own peculiar circumstances. It is sometimes difficult to compare Malta to national EU 25 data, since most operate at highly differentiated scales: national, regional and local levels. What could be termed as local in another country, such as a borough could be termed national in Malta; such are the differences in scale<sup>142</sup>.

There are also differences in urban and rural, conurbation and the cities' definition, amongst others. The island perspective may also suffer from high density, specific crimes related to maritime industry, colonial history, religious impact, political change and micro-economies. It would be interesting to see if criminality finds strange bedfellows in small island states.

- **The Data**

Statistics used in this cross-national comparison are expressed as crimes per 1000 persons. This allows for a comparative analysis across the different spatial aggregates and places different sized countries such as Malta, the United Kingdom and Poland on the same scale.

In reviewing this section, note has to be taken that not all countries report to the UN, thus the comparisons only stand for those that do report and this does not mean that their reports are extremely loyal to an international definition of what a particular crime represents: a case in

---

<sup>141</sup> [http://travel.state.gov/travel/cis\\_pa\\_tw/cis/cis\\_963.html](http://travel.state.gov/travel/cis_pa_tw/cis/cis_963.html)

<sup>142</sup> Thus, the need to look at both the large country comparison as well as the smaller island comparison.

point is reportage of domestic violence. As an example, a country may be rife in one type of crime such as beatings, but may not report the same crime.

- **The Investigated Data Categories**

The league of crime nations is based on the Seventh United Nations Survey of Crime Trends and Operations of Criminal Justice Systems (UN, 2003). The report covers the years 1998-2000 and the review covers the latest date possible: 2000, but where data is missing the next earliest figures are quoted. Since the UN report does not have any data on Malta, such was extracted from the local sources, as gathered from the Abstracts of Statistics (NSO, 1949-2000) and the Malta Police Data (extracted from the Police Information Retrieval System (PIRS)). For European countries that had missing data, such was mined from the European Regional Crime Database (Entorf *et al*, 2004)<sup>143</sup>.

Data reviewed in this section covers the main twelve crime categories listed in the UN 2003 report. The descriptions are taken from the United Nations (2003) InstrumentE (questionnaire) listing with descriptions for the Maltese inclusions within the respective categories as extracted from the Police PIRS data for 2000.

The methodology takes the approach of reviewing Malta's position against each crime category, then eliciting its ranking position for each of the two spatial levels analysed in this chapter: Europe, and Islands. A graduated map is produced for each category, with the European maps<sup>144</sup> listed in Appendix 6. Each category is described through its mean, rank, and the relative Malta's record in crimes per 1000 persons. The process then analyses Malta's grading against the Mean, which should show whether Malta has a higher or lower than mean record for that crime. The analysis finally rank's Malta's position against the group of countries under study. The results are then reviewed against each spatial level and a safety score created that would designate whether Malta is a relatively safe country or not. Table 7.4 lists the categories analysed and their descriptions.

---

<sup>143</sup> Horst Entorf and Hannes Spengler, European Regional Crime Database, Darmstadt University of Technology, March 2004

<sup>144</sup> Appendix 6 depicts maps as graduated with labelled crimes per 1000 persons.

Table 7.4: Crime Categories <sup>145</sup>

Crime Category	Comments
<b>Grand total of recorded crimes</b>	all recorded crimes but excludes traffic offences and petty crimes
<b>Assaults</b>	in Malta, assault is composed of: bodily harm, domestic violence, general bodily harm, threats and private violence, violence against public officer
<b>Automobile theft</b>	thefts of vehicle
<b>Bribery crimes</b>	in Malta, bribery is composed of: malversation (corruption) by public officer
<b>Burglaries (domestic and commercial)</b>	in Malta, burglary is composed of: theft from bars/hotels, theft from factories, theft from residence, and theft from retail outlets
<b>Drug offenses</b>	refers to drug cultivation, possession and trafficking
<b>Frauds</b>	fraudulent acquisition of other person's property
<b>Intentional homicide, attempted</b>	attempt to cause deliberate death including infanticide
<b>Intentional homicide, completed</b>	deliberate death including infanticide
<b>Rapes</b>	Malta's data is normally recorded as sexual offences not rapes, however research showed that rapes are reported at hospital and police then act on these reports. Data from Malta Today (2002) indicates that there were 30 cases of alleged rape <sup>146</sup> and attempted rape in 2000 as reported at one hospital. Rape in Malta is designated as full penetration. Recent police data shows that of the 30 cases reported in 2000, 13 were listed in the PIRS as rape.
<b>Robberies</b>	in Malta, robbery is composed of: hold-up, pick-pocketing, snatch and grab
<b>Thefts</b>	in Malta, theft is composed of: general theft, theft from beaches, theft from seacraft, theft from vehicle, theft of seacraft

## 7.2 A European perspective

The European perspective looks at Malta within a regional scenario, bound by similarities in culture and history. The crime categories are analysed in terms of crimes per 1000 persons and

<sup>145</sup> Note: Crime statistics are often better indicators of prevalence of law enforcement and willingness to report crime, than actual prevalence.

<sup>146</sup> The term alleged rape is used since confirmation of rape can only be done after conclusion of full Health Department and Police investigations. A number of rapes go unreported (as reported by Police Officer to author), whilst others are falsely reported (as detailed by a school head to author). The latter increases in summer when a number of foreign summer students studying the English language falsely report that they had been raped in order to mislead their families that they have had sex and possible gotten pregnant. This is a regular summer occurrence in the Maltese Islands, but each case has to be investigated properly to its satisfactory conclusion.

ranked by country as against other EU countries. The results are depicted in Table 7.5 which lists the countries<sup>147</sup> in alphabetical order and the relative crime data. The league-table describes the ranking that each country acquired and Malta's position within it.

*Research Question: Does Malta have a higher-than average crime rate in Europe?*

As a brief description of the table, the ranks indicate that some countries such as Greece are consistently registering at the bottom end of the scale. This is depicted in the table by a blue background which is the colour for the lowest crime rate of that particular crime category. In some cases more than one country are given this lowest tag, since they rank the same as other countries at the bottom of the rankings.

On the other end of the scale, a red tag indicates the highest ranking country for each crime category. Only England and Wales registered multiple-crime highest-rankings: on automobile theft and assaults. Also, in one particular crime category, the three Baltic countries of Estonia, Latvia and Lithuania together topped the intentional (completed) homicides ranking.

Malta, in general, ranked lowest on homicides, both completed and attempted, as well as in bribery. Malta had no experience as the highest ranking country in any category.

---

<sup>147</sup> Cyprus, Luxembourg and Sweden did not report crime data.

Table 7.5: EU Country League Table: 2000 ...cont

Country	Grand Total		Thefts		Robberies		Rapes		Intentional Homicide		Attempted Homicide	
	Per 1000	Ranking	Per 1000	Ranking	Per 1000	Ranking	Per 1000	Ranking	Per 1000	Ranking	Per 1000	Ranking
Austria	40.98	12	26.2	9	0.26	22			0.02	10		
Belgium	62.2	8	31.44	7	1.29	8			0.04	5		
Bulgaria	18.23	23	5.83	24	0.52	15	0.07	10	0.04	5	0.02	5
Czech Republic	38.01	14	15.06	13	0.4	18	0.05	15	0.02	10	0.01	14
Denmark	94.5	3	36.34	5	0.59	14	0.09	8	0.01	18	0.03	3
England and Wales	97.67	2	32.58	6	1.8	3	0.16	2	0.02	10	0.01	14
Estonia	42.22	11	10.39	19	3.47	2	0.05	15	0.1	1	0.03	3
Finland	102.43	1	22.08	11	0.5	16	0.11	6	0.03	7	0.05	2
France	64.04	7	39.64	3	0.41	17	0.14	3	0.02	10	0.02	5
Germany	76.21	5	37.02	4	0.72	11	0.09	8	0.01	18	0.02	5
Greece	9.7	26	2.36	26	0.08	27	0.01	25	0.01	18	0.01	14
Hungary	45.01	9	14.91	14	0.35	20	0.06	11	0.02	10	0.02	5
Iceland			26.63	8	0.12	26	0.26	1	0.02	10	0.01	14
Ireland	21.66	21	8.27	21	0.64	13	0.06	11	0.01	18		
Italy	38.23	13	23.7	10	0.65	12	0.04	19	0.01	18	0.02	5
Latvia	21.16	22	12.12	17	1.33	7	0.04	19	0.1	1		
Lithuania	22.29	20	14.42	15	1.18	9	0.05	15	0.1	1	0.01	14
Malta	43.510	10	16.490	12	1.380	5	0.03	23	0.010	18	0.010	14
Netherlands	82.12	4	45.8	1	1.17	10	0.1	7	0.01	18	0.09	1
Norway	73.5	6	42.81	2	0.4	18	0.12	5	0.01	18	0.02	5
Poland	32.74	18	6.25	22	1.38	5	0.06	11	0.06	4	0.01	14
Portugal	36.33	16	9.04	20	1.72	4	0.04	19	0.02	10		
Romania	16.43	25	6.03	23	0.18	25	0.05	15	0.03	7	0.02	5
Slovakia	16.44	24	4.88	25	0.23	24	0.02	24	0.03	7	0.01	14
Slovenia	34.01	17	10.73	18	0.24	23	0.04	19	0.02	10	0.02	5
Spain	23.37	19	13.66	16	12.59	1	0.14	3	0.01	18	0.02	5
Switzerland	37.74	15			0.3	21	0.06	11	0.01	18	0.01	14

Note: blank cells indicate unreported categories

Table 7.5: ...EU Country League Table: 2000

Country	Frauds		Burglaries		Bribery Crimes		Automobile Theft		Drug Offenses		Assaults	
	Per 1000	Ranking	Per 1000	Ranking	Per 1000	Ranking	Per 1000	Ranking	Per 1000	Ranking	Per 1000	Ranking
Austria			7.95	10			0.86	23	1.84	9	3.85	5
Belgium			17.74	2			3.41	7	3.63	3	4.67	4
Bulgaria	0.85	16	4.83	17	0.01	8	1.38	17	0.05	26	0.38	22
Czech Republic	2.6	6	7.21	11			2.31	13	0.43	17	2.14	12
Denmark	1.51	10	18.66	1			6.04	2	0.18	23	1.84	13
England and Wales	6.03	2	15.79	5			6.4	1	2.14	7	8.52	1
Estonia	1.32	12	17	3	0.05	3	1.7	15	1.15	11	0.34	24
Finland	2.89	3	16.92	4	0.02	5	3.17	9	2.6	6	5.37	2
France	2.42	8	6.3	13			5.12	4	1.76	10	1.81	14
Germany	10.9	1					1.01	21	2.97	4	1.42	15
Greece	0.04	24	1.5	22			0.8	24	0.33	19	0.31	25
Hungary	2.74	4	7.16	12	0.07	2	1	22	0.35	18	1.12	16
Iceland	1.44	11	8.57	7	0.01	8	1.38	17	2.78	5	4.93	3
Ireland	0.41	20	6.14	15			3.96	6	1.9	8	2.64	9
Italy	0.58	17					4.23	5	0.6	13	0.5	20
Latvia	0.04	24	4.16	20	0.02	5			0.28	20	0.35	23
Lithuania	0.41	20	2.49	21	0.01	8	1.4	16	0.26	22		
<b>Malta</b>	0.520	18	6.200	14	0.010	8	2.690	10	0.140	24	2.630	10
Netherlands	1.24	13	5.73	16			2.41	12	0.47	15	2.78	8
Norway	2.74	4	1.18	23			5.2	3	9.87	1	3.28	7
Poland	2.06	9	9.43	6	0.03	4	1.76	14	0.51	14	0.85	18
Portugal	0.52	18	4.73	18	0.01	8	2.64	11	0.65	12	3.8	6
Romania	1	15	0.95	24	0.52	1	0.2	26	0.02	27	0.42	21
Slovakia	0.23	23	4.72	19	0.01	8	1.12	20	0.11	25	0.69	19
Slovenia	2.47	7	8.03	9	0.02	5	0.71	25	0.47	15	1.11	17
Spain	0.39	22	0.6	25			3.41	7	0.28	20	2.29	11
Switzerland	1.08	14	8.41	8			1.3	19	6.48	2		

Note: blank cells indicate unreported categories

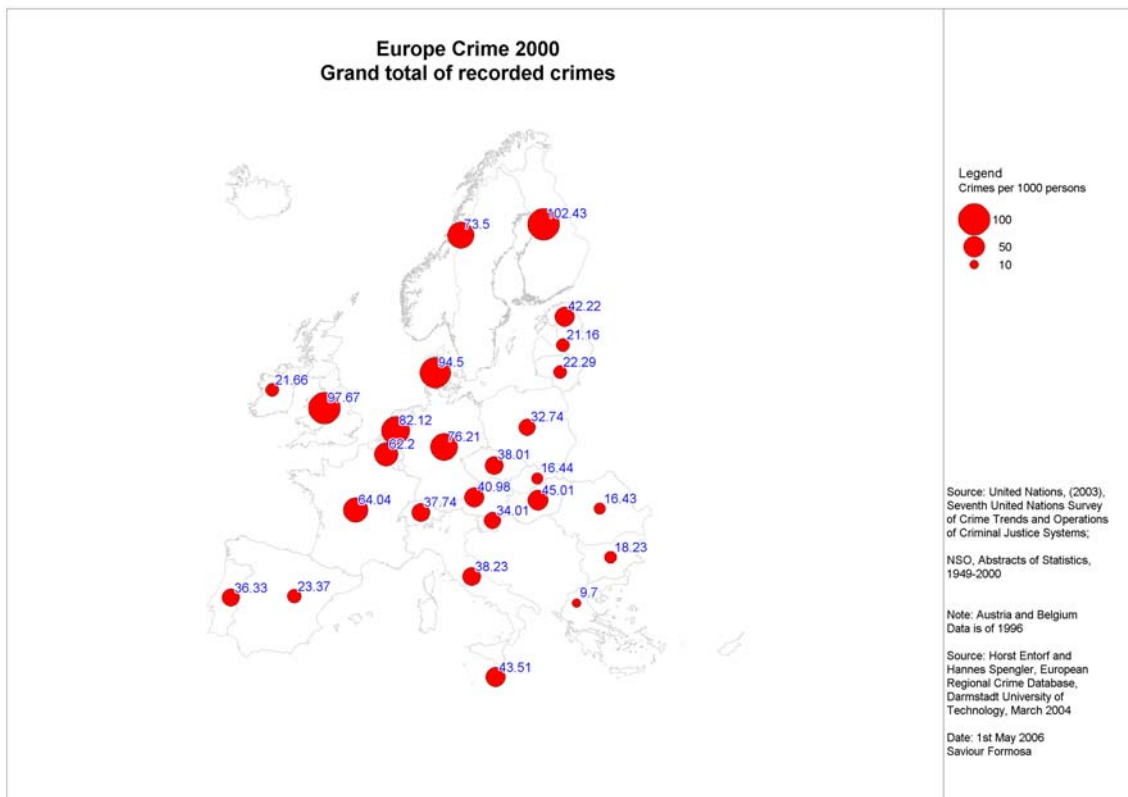


The next section analyses briefly each crime category, where Malta's position is analysed against the other countries. Refer to Table 7.4 for guidance. At the end of this analysis a summary table for Malta is given in Table 7.5 that lists Malta's crime categories positions in relation to the European mean, particularly whether they fall above or below the mean.

- **Grand total of recorded crimes**

The grand total of all recorded European crime counts show that Malta has a lower than the mean position, with 43.51 crimes per 1000 registered in 2000 against a wide range scenario ranging between a maximum of 102.43 for Finland against 9.7 for Greece, Malta ranks 10<sup>th</sup> of 26 countries. Interesting to note is the fact that the highest registering countries are northern European by location, such as Norway, Finland, Denmark, Germany, the Netherlands and England and Wales. The Mediterranean, Southern and East European countries tend to have lower per capita crime rates. Refer to Figure 7.3.

*Figure 7.3: Europe Grand total of recorded crimes – Graduated Map*



- **Assaults**

Assault figures show that Malta registered above the mean having had a ranking of 10 out of the 25 countries reporting across Europe. England and Wales had the highest assault crimes figures

at 8.52, followed by Finland at 5.37 per 1000. Also this scenario shows that the eastern European countries have a low assault rate as against the western states.

- **Automobile theft**

Automobile theft at the European scale, is one of the categories where Malta has a very high rate. With a rate of 2.69 crimes per 1000 persons, it placed 10th in the European ranking. The country with the highest number of automobile thefts per 1000 persons was England and Wales at 6.4, followed by Denmark at 6.04. As in the assault case there are lower rates for the eastern European states than there are for the western European states. This situation may reflect an affluence issue where there are fewer cars around in the eastern states as well as less expensive cars leading to a situation where cars are smuggled overland<sup>148</sup>.

- **Bribery crimes**

Malta ranked at the bottom of the scale in Europe at 0.01 per 1000 offences. Though the registered ranking was 8<sup>th</sup> out of 13 countries reporting bribery statistics, in actual fact it was at par with 6 other countries registering that same figure. Romania topped the list at 0.52 crimes per 1000 persons, followed by Hungary at 0.07.

- **Burglaries**

Malta ranked 14 out of 25 with a lower reading than the mean. With a rate of 6.2 crimes per 1000 persons, it falls way behind the highest number of burglaries for Denmark at 18.66, and Belgium at 17.74. A spatial analysis indicates that the countries registering that largest number of crimes per capita are clustered around the European centre with the addition of Finland.

- **Drug offenses**

Once again, Malta's drug offences are very small with a low rate of 0.14 per 1000 persons and a ranking of 24 out of 27 reporting countries. Spatial analysis shows the dearth of offences in an arc spanning southern and eastern Europe. The two countries that registered the highest rate at were Norway at 9.87 followed by Switzerland at 6.48.

- **Frauds**

Frauds in Malta are small in number as reflected by a lower than European mean. Frauds ranked Malta at an 18<sup>th</sup> position of 25. The two countries registering the highest number of frauds per 1000 persons were Germany at 10.9, followed by England and Wales at 6.03. As in the drugs scenario, the countries reporting the lowest rates for fraud sit in an arc spanning southern and

---

<sup>148</sup> Evidenced by author in Albania, Kosovo and Macedonia in 1999 following the war in Kosovo. Interviews with locals elicited the statement that most cars were unlicensed, uninsured and there was no apparent control to investigate origin of vehicle.

eastern Europe. It is interesting to note that the highest offence rates can be found in the countries that have been identified as forming part of the European pentagon dealing with high industrial and economic output by the ESPON (European Spatial Planning Observatory Network<sup>149</sup>).

- **Intentional homicide, attempted**

Attempted homicides place Malta in the lowest category as it shares this position with 9 other countries, (marked 14<sup>th</sup> through alphabetical listing) out of 22 European reporting countries, registering 0.01 attempts per 1000 persons. Whilst Europe as a whole has a low homicide rate, the highest rate can be found in The Netherlands at 0.09 and Finland at 0.05, though the latter two are still at least 1 factor smaller than the highest ranking countries in the global scenario.

- **Intentional homicide, completed**

Completed homicides also place Malta in the lowest category as it shares this position with 9 other countries, (though marked 18<sup>th</sup> through alphabetical listing) out of 27 European reporting countries, registering 0.01 attempts per 1000 persons. Interestingly, as against attempted homicides, the picture for completed homicides changes totally as the Netherlands ranks at the bottom alongside Malta, indicating the need to investigate how many homicides are stopped before they go the full track. Also the spatial scenario shifts from the Nordic countries to the eastern Baltic States and Poland. Estonia, Lithuania and Latvia register a factor above the lowest countries at 0.1 crimes per 1000, whilst Poland notched 0.06.

- **Rapes**

At a rate of 0.03, Malta's rate is lower than mean level, ranking the islands 23<sup>rd</sup> of 25 countries. Whilst the western and Nordic states register the highest rates for Europe, eastern countries as a whole exhibit a lower number of rapes. The country with the highest rates was Iceland (0.26), followed by England and Wales (0.16).

- **Robberies**

Malta registers a very high rate for robberies, where at 1.38 crimes per 1000 persons, it ranks 5<sup>th</sup> in the European list of 27 countries. Spain dominates European robberies by far at 12.59, with second position going to Estonia at a distant 3.47, thus rendering Spain's result as an outlier. In effect, should the outlier be removed, Malta's effective ranking would be even higher.

---

<sup>149</sup> <http://www.espon.lu>

- **Thefts**

Malta's theft ranking stands at 12<sup>th</sup> of 26 countries with a rate of 16.49 crimes per 1000 persons, going below the European mean of 19.8. The top countries were the Netherlands with 45.8, followed by Norway at 42.8.

In summary, Table 7.6 lists the crime descriptions in a simple table. It indicates that Malta falls within a relative safety category of crime, which scores below the mean for the grand total as well as in 8 categories of crime. In 3 of the latter, Malta has the lowest crime rate for Europe; the completed and attempted homicide categories and bribery. In the case of robberies, automobile theft and assaults Malta has an above-the-mean score. The ranking fields indicate the relative position of Malta for each crime category as against the number of countries reporting that type of data. The dark orange shading indicates a rank higher than the mean.

Table 7.6: Malta's relative position in the league table based on the European mean: 2000

Country	Grand Total	Thefts	Robberies	Rapes	Intentional Homicide	Attempted Homicide	Frauds	Burglaries	Bribery Crimes	Automobile Theft	Drug Offenses	Assaults
<b>Mean</b>	45.797	19.795	1.256	0.078	0.029	0.021	1.857	7.696	0.061	2.523	1.565	2.322
<b>Malta</b>	43.510	16.490	1.380	0.03	0.010	0.010	0.520	6.200	0.010	2.690	0.140	2.630
<b>Malta's Mean position</b>	Lower than Mean	Lower than Mean	Higher than Mean	Lower than Mean	Lower than Mean – Lowest Country in EU	Lower than Mean – Lowest Country in EU	Lower than Mean	Lower than Mean	Lower than Mean – Lowest Country in EU	Higher than Mean	Lower than Mean	Higher than Mean
<b>Ranking (out of 30 max)</b>	<b>10</b>	<b>12</b>	<b>5</b>	<b>23</b>	<b>18</b>	<b>14</b>	<b>18</b>	<b>14</b>	<b>8</b>	<b>10</b>	<b>24</b>	<b>10</b>
Recording countries	26	26	27	25	27	22	25	25	13	26	27	25

- **Clustering the European countries – establishing Malta’s position**

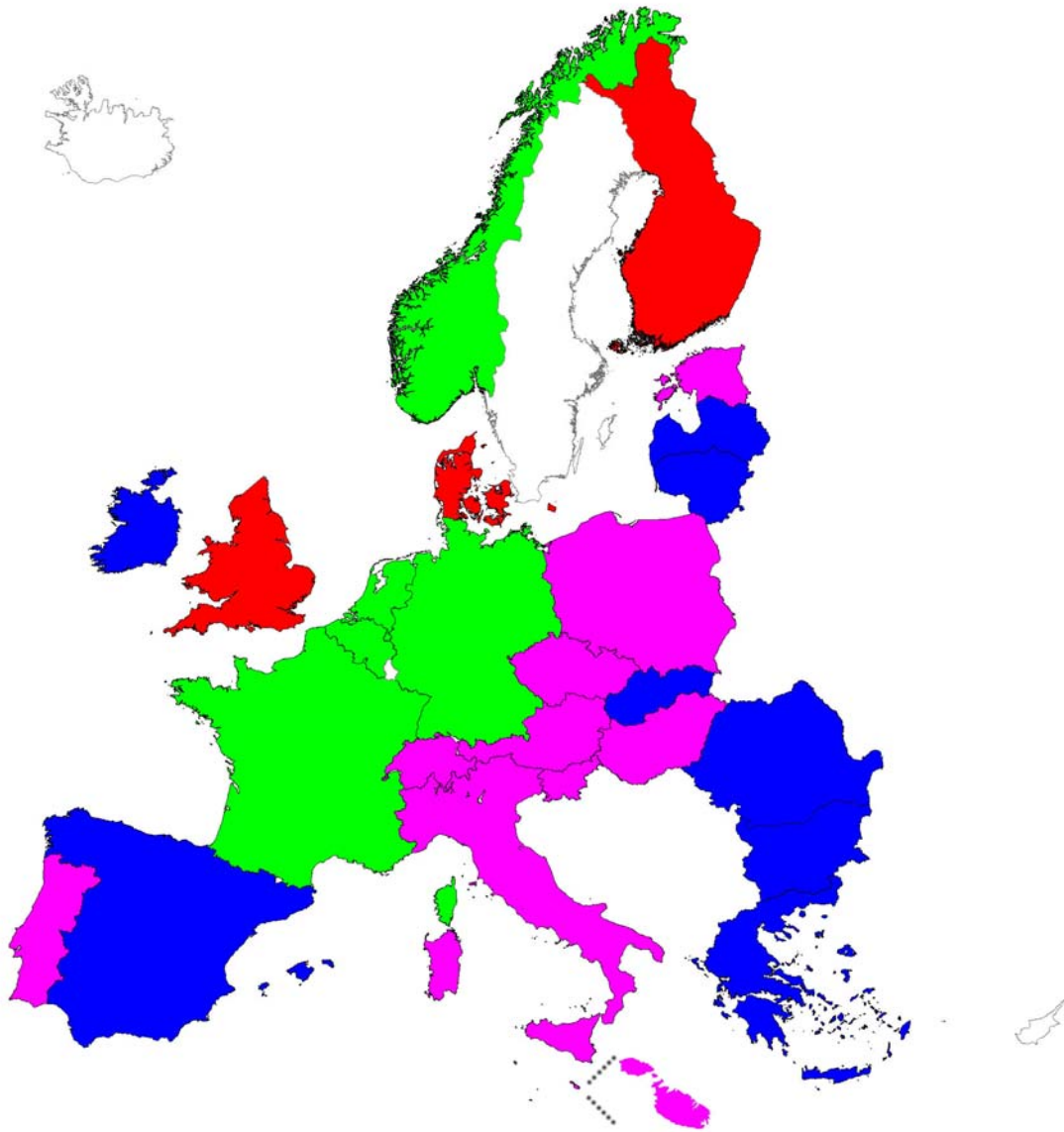
Cluster Analysis was carried out for the Grand Total of crimes based on a 4-group output (Table 7.7 and Figure 7.4). Whilst the first group composed of Northern countries Denmark, England and Wales and Finland occupy the highest-crime rate group, they are followed by another group of northern countries. Results show that Malta inhabits one of the lower (fewer crimes per 1000 persons) groups with 9 other countries. Malta’s position within the third group, indicates a relatively safer category composed of Mediterranean countries, Portugal and central and eastern European countries. The least crime-reporting countries fall within a group of peripheral countries in the Mediterranean, Atlantic and Baltic states.

*Table 7.7: European Grand Total Crimes Cluster Analysis: 2000*

Country	Grand Total Cluster
Denmark	1
England and Wales	1
Finland	1
Belgium	2
France	2
Germany	2
Netherlands	2
Norway	2
Austria	3
Czech Republic	3
Estonia	3
Hungary	3
Italy	3
Malta	3
Poland	3
Portugal	3
Slovenia	3
Switzerland	3
Bulgaria	4
Greece	4
Ireland	4
Latvia	4
Lithuania	4
Romania	4
Slovakia	4
Spain	4

In effect, such clustering highlights the issue that neighbouring countries have to a certain extent similar crime groups, except for the fourth group that is only related by its peripherality. The first cluster also shows a distinct cluster that may be resultant from specific circumstances that are not investigated here.

*Figure 7.4: European Grand Total Crimes Cluster Map*



Source: The Author

### **7.3 An Island Perspective**

Following an analysis of Malta within its regional and continental setting, where differently-sized countries were examined, the ideal way to analyse Malta's situation is through an analysis of similarly-sized spatial context.

Research Question: Does Malta have a higher-than average crime rate in comparison to other Islands?

At the micro perspective, eight island states from different regions in the world were chosen, and assessed for their crime statistics in order to try and elicit some similarities at such a small spatial level as against the larger European level. The other islands reviewed were; Barbados, Dominica, Hong Kong - SAR of China, Jamaica, Mauritius, Seychelles, and Singapore.

As in the European description of Table 7.5, the islands results are depicted in Table 7.8 which league-table describes the ranking that each country acquired and Malta's position within it. The summary table for Malta is given in Table 7.9 that lists Malta's crime categories positions in relation to the island mean, which in the islands' case, registers differently than the European perspective. Where Malta was compared to relatively huge countries, Malta came out relatively unscathed, with few above-the-mean crime categories. However, in the islands' case, the number of above-the-mean categories grew to 5 from a European 3.

The colour tabs once again show that one country tops the list for relative safety, which country is Singapore, closely followed by Malta as against a highest crime ranking for Dominica, the latter having three highest ranking categories. However, Malta registers the highest for automobile thefts. Even so, this result shows that Malta is one of the safest countries in both the European and Islands' perspectives.

As in the European case, each crime category is briefly analysed in the next section.

- **Grand total of recorded crimes**

The grand total of recorded Island crime counts shows that Malta has a higher than mean position. With 43.51 crimes per 1000 registered in 2000 against a maximum registration of 107.63 for Dominica followed by Seychelles at 53.69, Malta ranks 3<sup>th</sup> of 8 countries. Interesting is the fact that the Asian countries of Singapore and Hong Kong registered the lowest rates. Refer to Figure 7.5 for a graphical depiction of the grand total results.



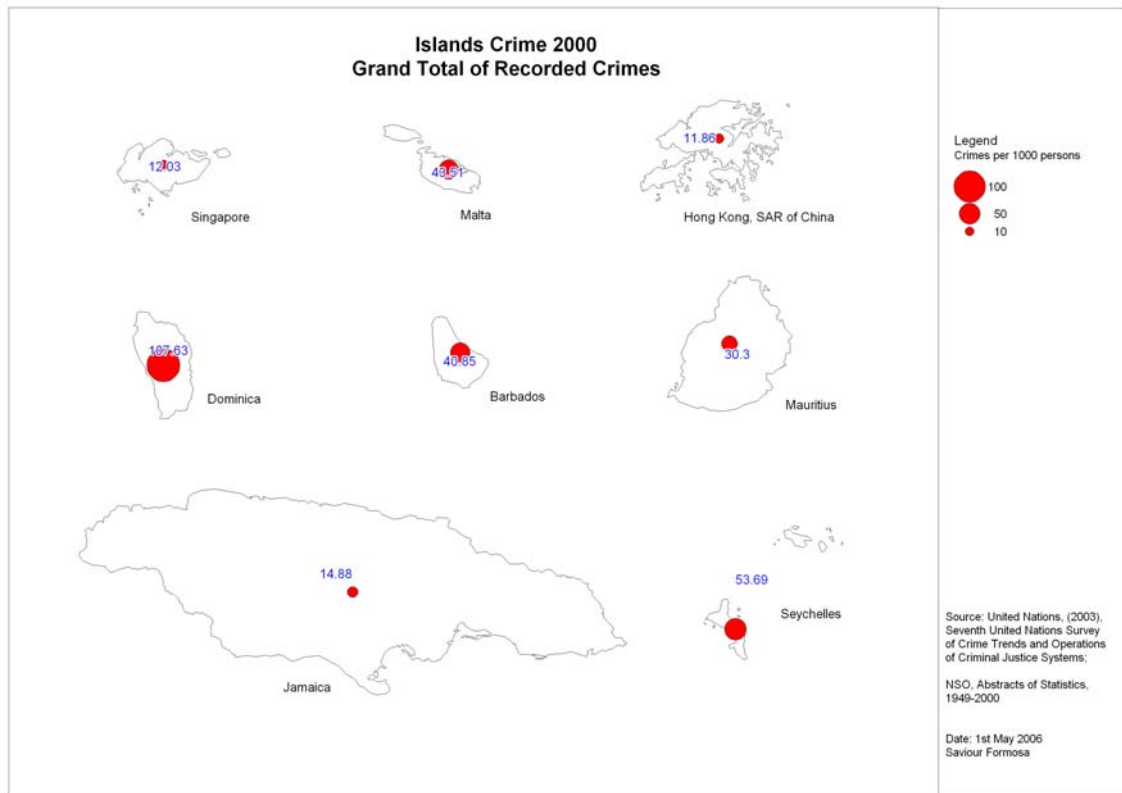
Table 7.8: Islands Country League Table: 2000

Country	Grand Total		Thefts		Robberies		Rapes		Intentional Homicide		Attempted Homicide	
	Per 1000	Ranking	Per 1000	Ranking	Per 1000	Ranking	Per 1000	Ranking	Per 1000	Ranking	Per 1000	Ranking
Barbados	40.85	4	8.70	4	1.60	1	0.25	4	0.07	2		
Dominica	107.63	1	31.22	1	0.78	5	0.33	3	0.03	4		
Hong Kong, SAR of China	11.86	8	4.50	6	0.51	7	0.02	7	0.01	6		
Jamaica	14.88	6	1.88	8	0.89	4	0.50	2	0.34	1	0.39	1
<b>Malta</b>	<b>43.510</b>	<b>3</b>	<b>16.490</b>	<b>2</b>	<b>1.380</b>	<b>2</b>	<b>0.03</b>	<b>5</b>	<b>0.010</b>	<b>6</b>	<b>0.010</b>	<b>2</b>
Mauritius	30.30	5	8.04	5	0.98	3	0.02	7	0.02	5	0.01	2
Seychelles	53.69	2	10.07	3	0.65	6	0.79	1	0.07	2		
Singapore	12.03	7	4.20	7	0.12	8	0.03	5	0.01	6		

Country	Frauds		Burglaries		Bribery Crimes		Automobile Theft		Drug Offenses		Assaults	
	Per 1000	Ranking	Per 1000	Ranking	Per 1000	Ranking	Per 1000	Ranking	Per 1000	Ranking	Per 1000	Ranking
Barbados	0.85	2	11.10	2			0.84	3	5.46	1	5.77	3
Dominica	0.44	6	17.77	1			0.99	2	3.70	3	0.96	7
Hong Kong, SAR of China	0.75	4	1.32	6	0.49	1	0.41	4	0.34	7	1.10	6
Jamaica	0.44	6	0.92	7	0.01	3	0.10	6	4.52	2	4.11	4
<b>Malta</b>	<b>0.520</b>	<b>5</b>	<b>6.200</b>	<b>3</b>	<b>0.010</b>	<b>3</b>	<b>2.690</b>	<b>1</b>	<b>0.140</b>	<b>8</b>	<b>2.630</b>	<b>5</b>
Mauritius	0.77	3	1.34	5	0.01	3			2.08	5	9.09	1
Seychelles	1.62	1	2.79	4					3.14	4	8.62	2
Singapore	0.36	8	0.25	8	0.04	2	0.41	4	1.05	6	0.13	8

Note: blank cells indicate unreported categories

Figure 7.5: Islands Grand Total of recorded crimes – Graduated Map



- **Assaults**

Whilst in the European perspective Malta registered higher than the mean positions, at an island level it is defined as one of the island communities with the lowest rate for assault signifying that in an island states comparison, Malta’s position on assault compares favourably with Europe as a whole. Malta (2.63) ranked 5<sup>th</sup> of 8 islands, with Mauritius (9.09) and Seychelles (8.62) topping the ranks.

- **Automobile theft**

Having ranked high amongst the European perspective, automobile theft ranking at small island level comes as no surprise. Malta occupies the top position at a rate of 2.69 crimes per 1000 persons, nearly two standard deviations above the mean, effectively rendering Malta an outlier in this scenario. Malta’s position is followed by Dominica at 0.99 per 1000, which is far below the Maltese level. In comparison to the European case, there may be several reasons for this, amongst them affluence, a ready market for spare parts, and easily accessible short routes to export material from disassembled vehicles. These ‘opportunities’ may not be available to all islands, particularly the export routes issue.

- **Bribery crimes**

Malta's bribery status has been shown in the European perspective to be very low, ranking at the bottom of the scale at 0.01 per 1000 offences. In the islands' case this is still the case as Malta registered 3<sup>rd</sup> out of 5 countries reporting bribery statistics, where in actual fact it was at par with 3 other countries registering the lowest figure. Hong Kong topped the list at 0.49 crimes per 1000 persons, followed by Singapore at a factor difference of 0.04.

- **Burglaries**

Malta ranks 3<sup>rd</sup> out of 8 countries with higher readings than the mean. With a rate of 6.2 crimes per 1000 persons, it falls behind the highest number of burglaries for Dominica at 17.77, and Barbados at 11.1. At the global scenario, it was ascertained that these two islands rank amongst the highest global ranking countries.

- **Drug offenses**

At an island level, Malta strengthens its position as a relatively drug-free society with a very low rate of 0.14 per 1000 persons and a ranking at the bottom of the scale of 8 countries. The two countries registering the highest rates were the Caribbean islands of Barbados (5.46), Jamaica (4.52) and Dominica (3.7) and relatively low for the Asian islands.

- **Frauds**

Frauds in small states is relatively low at a mean of 0.72. Malta ranked 5<sup>th</sup> of the 8 islands with the highest number of frauds per 1000 persons being registered in Seychelles at 1.62, followed by Barbados at half that rate (0.85).

- **Intentional homicide, attempted and completed**

Malta ranks at the bottom of the scale for both attempted and completed homicides at 0.1 offences per 1000 persons. Jamaica tops the list for both type of crimes at 0.39 for attempted and 0.34 for completed homicides.

- **Rapes**

At a rate of 0.03, Malta's rape rate is below the mean for islands states, ranking the islands 5<sup>th</sup> of 8 countries. Seychelles and Jamaica register the highest rates at 0.79 and 0.5 respectively.

- **Robberies**

As reviewed in the European scenario, Malta registers a very high rate for robberies. With a rate of 1.38 crimes per 1000 persons, it ranks 2<sup>nd</sup> in the islands ranking. Malta is second only to Barbados at 1.6.

- **Thefts**

Malta ranks highly for thefts with a rate of 16.49 crimes per 1000 persons, going above the islands mean of 10.64. Malta ranks second to Dominica that registered 31.22.

In summary Table 7.9 indicates that Malta again falls within a relative safety category of crime, though it scores below the mean for 7 categories of crime. In the case of grand total, theft, robberies, automobile theft and burglaries, Malta has an above-the-mean score. The automobile theft category hits the top position in the Islands perspective with theft and robberies ranking second.

- **Clustering the Islands – establishing Malta’s position**

A clustering analysis was carried out on grand total crime based on a 3-group output (Table 7.10 and Figure 7.6). Malta falls within the second cluster together with Barbados and Seychelles. This is the middle-of-the-road ranking, particularly since Dominica is such an outlier that it cannot be clustered with other groups but inhabits a group of its own. The last cluster is made up of the rest of the island countries, which have a relatively safer record, even though Jamaica has a higher homicide rate.

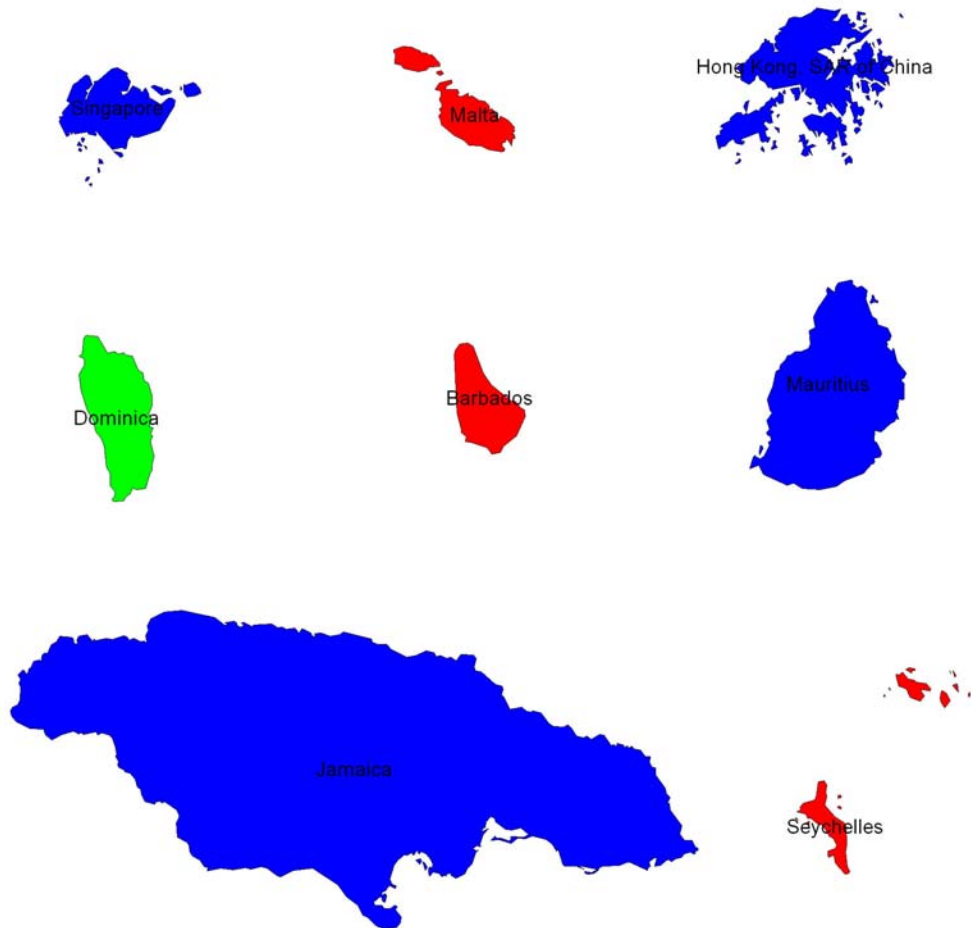
Table 7.9: Malta's relative position in the league table based on the Islands mean: 2000

Country	Grand Total	Thefts	Robberies	Rapes	Intentional Homicide	Attempted Homicide	Frauds	Burglaries	Bribery Crimes	Automobile Theft	Drug Offenses	Assaults
<b>Mean</b>	39.344	10.638	0.864	0.246	0.070	0.137	0.719	5.211	0.112	0.907	2.554	4.051
<b>Malta</b>	43.510	16.490	1.380	0.03	0.010	0.010	0.520	6.200	0.010	2.690	0.140	2.630
<b>Malta's Mean position</b>	Higher than Mean	Higher than Mean	Higher than Mean	Lower than Mean	Lower than Mean – Lowest Country in Islands	Lower than Mean – Lowest Country in Islands	Lower than Mean	Higher than Mean	Lower than Mean – Lowest Country in Islands	Higher than Mean – Highest Country in islands	Lower than Mean – Lowest Country in Islands	Lower than Mean
<b>Ranking (out of 8)</b>	<b>3</b>	<b>2</b>	<b>2</b>	<b>5</b>	<b>6</b>	<b>2</b>	<b>5</b>	<b>3</b>	<b>3</b>	<b>1</b>	<b>8</b>	<b>5</b>
Recording countries	8	8	8	8	8	3	8	8	5	6	8	8

Table 7.10: Islands Grand Total Crimes Cluster Analysis

Country	Grand Total Cluster
Dominica	1
Barbados	2
Malta	2
Seychelles	2
Hong Kong, SAR of China	3
Jamaica	3
Mauritius	3
Singapore	3

Figure 7.6: Islands Grand Total Crimes Cluster Analysis



Source: The Author

### Summary of the Main Points

The main points emanating from this analysis can be summarized in the fact that Malta is a relatively safe country, which is clustered towards the lower ends of the crime rate rankings both at European and Island categories. The data is more relevant to the islands than the European

perspective where Malta is a very small partner with a high density and closed boundaries. In the European case it clustered with the nearest neighbour: Italy, whilst in the Islands' analysis it clustered with the smallest countries.

The best way to elicit other similarities or differences is to review the results through a comparative category analysis of the European and Islands' perspectives.

### 7.2.3 Comparative Analysis: Macro - Micro

Whilst the previous section was aimed at preparing the base data for the placement of Malta in an international construct based on crimes per 1000 persons, the following section brings together and compares Malta's position against each macro and micro levels for each crime category.

Table 7.11 depicts the mean for the European and Islands' analysis, the minimum and maximum rate per 1000 persons, as well as Malta's mean and relative mean position above or below the mean.

- **Grand total of recorded crimes**

Malta experienced a high rate of total crimes within the two levels and registers higher than mean readings at islands level with very close to mean reading at macro level.

- **Assaults**

Malta experienced a high rate of assaults across the macro level with close to mean results. Interestingly, comparative analysis shows that islands tend to have a higher mean, which in effect lowers Malta's relative position to below the mean.

- **Automobile thefts**

Malta's automobile thefts statistical position is 'secure' at all levels, as it tops all statistical measures. The European level shows a high mean which situation is enhanced at the micro level where islands register a low mean, thus accentuating Malta's relative position.

- **Bribery crimes**

An analysis of the bribery category indicates that moving from the macro to micro level, the potential for bribery increases. The mean practically nearly doubles between the levels. The potential for bribery growth at European level may be accounted for due to the high position attained by Romania. Malta registers a low bribery rate at all mean levels.

- **Burglaries**

The analysis of burglaries elicits the fact that the mean ranges are relatively close for the macro and micro levels, with Malta having a higher-than-mean at island level as against a lower one at EU level.

- **Drug Offences**

Drug offences suffer an increase in incidence at micro level, mainly due to the heavy weighting by the three Caribbean islands of Barbados (5.46), Jamaica (4.52) and Dominica (3.7) in such a small group. Malta's position is very low at all levels.



Table 7.11: Comparative Macro-Micro Analysis Table: 2000

Measure	Grand Total		Thefts		Robberies		Rapes		Intentional Homicide		Attempted Homicide	
	Europe	Islands	Europe	Islands	Europe	Islands	Europe	Islands	Europe	Islands	Europe	Islands
<b>Mean</b>	45.797	39.344	19.795	10.638	1.256	0.864	0.080	0.253	0.029	0.070	0.021	0.137
<b>Max</b>	102.430	107.630	45.800	31.220	12.590	1.600	0.260	0.790	0.100	0.340	0.090	0.390
<b>Min</b>	9.700	11.860	2.360	1.880	0.080	0.120	0.010	0.020	0.010	0.010	0.010	0.010
<b>Malta</b>	43.510	43.510	16.490	16.490	1.380	1.380	0.030	0.030	0.010	0.010	0.010	0.010
<b>Malta's Mean position</b>	Lower than Mean	Higher than Mean	Lower than Mean	Higher than Mean	Higher than Mean	Higher than Mean	Lower than Mean	Lower than Mean	Lower than Mean	Lower than Mean	Lower than Mean	Lower than Mean

Measure	Frauds		Burglaries		Bribery Crimes		Automobile Theft		Drug Offenses		Assaults	
	Europe	Islands	Europe	Islands	Europe	Islands	Europe	Islands	Europe	Islands	Europe	Islands
<b>Mean</b>	1.857	0.719	7.696	5.211	0.061	0.112	2.523	0.907	1.565	2.554	2.322	4.051
<b>Max</b>	10.900	1.620	18.660	17.770	0.520	0.490	6.400	2.690	9.870	5.460	8.520	9.090
<b>Min</b>	0.040	0.360	0.600	0.250	0.010	0.010	0.200	0.100	0.020	0.140	0.310	0.130
<b>Malta</b>	0.520	0.520	6.200	6.200	0.010	0.010	2.690	2.690	0.140	0.140	2.630	2.630
<b>Malta's Mean position</b>	Lower than Mean	Lower than Mean	Lower than Mean	Higher than Mean	Lower than Mean	Lower than Mean	Higher than Mean	Higher than Mean	Lower than Mean	Lower than Mean	Higher than Mean	Lower than Mean

- **Frauds**

Malta has a low fraud rate at both levels. There is a distinct macro-micro difference in that at EU level the mean level is twice that of the islands' level. This could mean that there are less real frauds or that inversely it could be rife but is so ingrained in social practices that it goes unreported.

- **Intentional homicides - attempted**

Malta has a very low attempted homicide rate at all levels reaching bottom ranking rates. Interestingly the micro level sees the highest means, mainly due to the comparatively high reporting number of countries, amongst them Jamaica at 0.39.

- **Intentional homicides - completed**

As in the case of attempted homicides, Malta has a very low completed homicide rate at both levels reaching bottom ranking rates. Again, the micro level saw an increase in the highest means.

- **Rapes**

Rapes at island level figures indicate that there is a tripling of rates from macro to micro level, mainly due to the heavy rates for two islands of Seychelles (0.79) and Jamaica (0.5). This effectively pushes Malta's relative position to a very low position.

- **Robberies**

At micro level the robbery rate falls, indicating a less dangerous situation in island states than at macro levels. This situation essentially pushes Malta's micro position in a relatively higher mode than that at macro level.

- **Thefts**

Thefts experience a decrease for micro levels that are lower than the macro levels. A situation of high European crime rates pushes Malta to a lower mean state at macro level.

### **Summary of the Main Points**

In summary, Malta is a relatively safe country both at macro and micro levels. The macro-micro analysis shows that islands register higher means per category than the EU level. Six categories have a higher mean than the EU, though the Grand Total shows otherwise. A deeper analysis shows that islands register five categories that have higher means for serious crimes. In the case

of assaults, drug offences, homicides (attempted and completed) and rapes, the islands have a higher mean. Robberies is the serious category that has a higher mean at EU level. In view of this, the islands are more dangerous places than the larger EU countries. In the case of less serious crimes, the inverse is true: islands have lower means for vehicle theft, burglaries, fraud and thefts with bribery being lower than the EU mean.

Within this context, Malta appears to be relatively safe since it registers lower means for all serious crimes than the Islands' (micro) means except for robberies. Malta's means show similarities to the EU norm in all serious categories. However, for the non-serious offences it registers higher levels for vehicle theft, burglaries and theft than those of the other islands, making it more dangerous at this level, a finding once again similar to the EU macro-micro outcome except for fraud.

In summary, Malta, though having similar physical characteristics to other islands (insularity, density and size), it experiences a different offence structure that reflects more the macro EU level than the micro Islands' level.

#### 7.2.4 Creating a score model for the placement of Malta's safety status

The previous sections indicated Malta's position in a macro and micro level comparison at European and Island perspectives as at 2000. This structure enabled the creation of a ranking system as well as a mean positioning system. Once this structure has been established a model can be developed that helps analyse Malta's relative position vis-à-vis each category of crime at mean over a number of years. Such a system enables a trend analysis of relative safety over time in this case covering a three-year period from 1998 to 2000.

This section attempts to create the structure that can be used as a gauge for annual trend analysis at national, regional and local levels.

The approach taken is based on Kwan *et al's* (2000) identification of 4 crime categories (murder, rape, drug offences and robbery) that would be termed as most serious with the rest being declared least serious. In view of this, a grading system by crime category weighted for the same type of seriousness has been created and contrasted against each crime category mean result as detailed below:

- i) Classification of most serious and least serious crimes based on the categories above

In Malta's case, Kwan *et al's* (2000) most serious categories are kept with the addition of assaults as it is deemed as a highly serious offence due to potential wounding and aggravated bodily harm that could lead to death. Table 7.12 lists the crimes within each of the categories;

Table 7.12: Seriousness and Mean Placing Weightings

Category	Weighting
<b>Most Serious</b>	
Assaults	x2
Drug offenses	x2
Attempted homicide	x2
Intentional homicide	x2
Rapes	x2
Robberies	x2
<b>Least Serious</b>	
Automobile theft	x1
Bribery crimes	x1
Burglaries	x1
Frauds	x1
Thefts	x1

Placing	Rating
Mean level	0
Above Mean	1
Below Mean	-1

- ii) A grading for seriousness is given where a weighting<sup>150</sup> of **2** is given for the most serious and **1** for the least serious crimes (Table 7.12);
- iii) A rating was devised that would award **+1** for above mean position placing in each of the categories reviewed above, award **-1** for below the mean position and a **0** for positions at the mean value (Table 7.12);
- iv) A matrix was created to analyse Malta's position for each crime category (Table 7.13) based on i) to iii) above and totals calculated;
- v) The results for each macro-micro level is depicted onto a scale that outlines the whole range possible for country placement within the model. Maximum figures would range from **-17** to **+17** with **-17** representing a very safe state (country) with least crime and a **+17** score would indicate a highly dangerous state (Figure

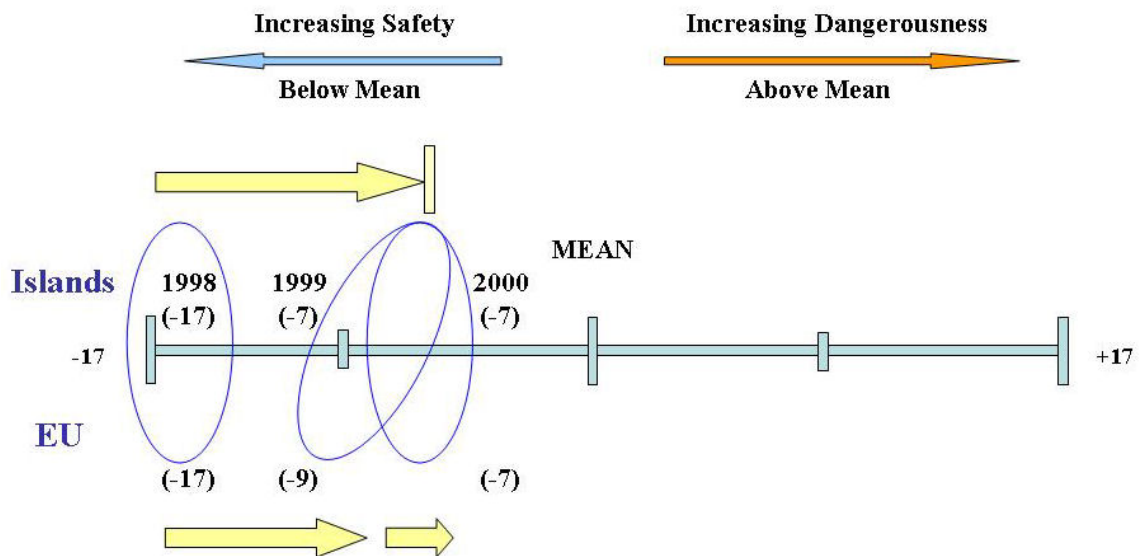
<sup>150</sup> This weighting method was chosen in view of the unavailability of studies gauging local perception to crime seriousness. The relative double weights given to serious offences as against non-serious reflect do not necessarily reflect the fact that assault is twice as dangerous as vehicle theft, but serve as a basis for future studies in line with Kwan et al's 2000 study.

7.7). A zero (0) on the scale indicates the state's mean placing at both the EU and Islands levels.

Table 7.13: Crime categories Matrix Calculations – Malta's 'relative safety-danger' position

	1998	1999	2000	1998	1999	2000
Category	Europe	Europe	Europe	Islands	Islands	Islands
<b>Most Serious</b>						
Assaults	-2	2	2	-2	-2	-2
Drug offenses	-2	-2	-2	-2	-2	-2
Attempted homicide	-2	-2	-2	-2	-2	-2
Intentional homicide	-2	-2	-2	-2	-2	-2
Rapes	-2	2	-2	-2	-2	-2
Robberies	-2	-2	2	-2	2	2
<b>Least Serious</b>						
Automobile theft	-1	-1	1	-1	1	1
Bribery crimes	-1	-1	-1	-1	-1	-1
Burglaries	-1	-1	-1	-1	1	1
Frauds	-1	-1	-1	-1	-1	-1
Thefts	-1	-1	-1	-1	1	1
<b>Totals</b>	<b>-17</b>	<b>-9</b>	<b>-7</b>	<b>-17</b>	<b>-7</b>	<b>-7</b>

Figure 7.7: Relative Safety-Danger Score Model: 1998-2000



Source: The Author

The score results show that Malta is a relatively safe country when compared to both the European and Island perspectives, having experienced lower than mean results for all three years under review. However, the change analysis indicates a rapidly changing scenario. At Island level, Malta had the safest possible level in 1998 at a score of -17, which figure rapidly shot towards the mean to -7 and stabilised there for 1999 and 2000. At the European level, the 1998 - 17 score again shot up to -9 in 1999 and then again to -7 in 2000. Such figures show that crime is very dynamic and Malta's increasing crime levels is having a progressive effect on its international safety score.

This score model can be employed at NUTS4 and NUTS5 levels to elicit the trends at the most functional policy-making levels: the district and local council levels. When analysed over a number of years, the model can be used to identify shifts in temporal trends at intra-country level as well as create a safety ranking table for each locality.

#### 7.2.5 Summary

In summary, a relative-safety ranking exercise identified an initial Maltese Islands safety record at well below the macro and micro mean as resulting from the crime category analysis at both European and Islands perspectives. The study also showed that islands are more dangerous places than the larger EU level, with Malta having a greater affinity to the EU crime characteristics than those found in islands.

The score model at both macro and micro levels indicated a relatively safe country with decreasing relative safety.

#### 7.3 Conclusion

The chapter has sought to place Malta in a criminological framework over space and time, based on data at national and international levels. The study reviewed a 40-year crime analysis at national level and attempted to identify specific issues and trends. The study then looked at Malta's international position where the issue of Malta's 'relative safe' status was determined.

A 40-year analysis of Maltese historical crime-related data depicted a rapidly increasing crime rate and a structural change in crime categories reported over the decades.

The 'Malta in an international scenario' helped identify issues at European and Islands level. Eleven crime categories and the grand total crime were analysed, each placing Malta in a mean-based comparative analysis on crimes per 1000. The results show a relatively low rate for most serious which differ over the two spatial levels. A methodology was created resulting in a score model that placed Malta at the different spatial level within a relative safety-dangerousness scale where Malta was deemed safe, though progressively decreasing in relative safety. The model can be used over time to analyse changes and for different countries and sub-national levels since it has a dynamic structure that changes with each annual data input.

Cluster analysis showed that Malta shares the same group as its immediate European neighbours as well as sharing a similar island size cluster. Malta is placed within relatively safer (low-rates) groups in both levels, even though it may spike in some offences such as automobile theft at islands level.

Detailed analysis showed that Malta experiences a crime structure that is closer to the EU level than the Islands' level, the latter experiences higher rates of serious crimes and lower rates of non-serious crimes.

This chapter helped set out a national base structure from criminological research in the Maltese Islands, where none existed before, giving a new perspective on crime in Malta. Much still needs to be done but the base structure now exists for this and future studies. This done, the next phase will take at detailed analysis of crime over the 50-year period from 1950 to 1999 based on offender data at different spatial levels. The analysis is based on spatio-temporal analysis employing GIS technology.

## **Chapter 8: Crime analysis in relation to social issues and poverty: an offender-offence approach**

### Introduction

Chapter 8 reviews two components of the CRISOLA structure: crime and the social parameters. It takes a three-pronged approach, through an analysis of convicted offender's social parameters and how they relate to the environment, their related offences and finally reviews this relationship in an offender-offence perspective. The research reviews the temporal construct mainly how offences meriting imprisonment changed over time, the issues pertaining to residence location, their demographic and socio-economic characteristics, the incidence of recidivism, their crime type evolution, as well as other crime-related parameters. The study then looks at both the spatial and temporal characteristics of the offender-offence relationship during the last decade of the century. Throughout, the results lead to analysis of the 1990's crime and social relationships based on a review of poverty in a spatial context and how it relates to the offender and offence location.

This chapter incorporates 50 years of convicted offender data covering the time period 1950 to 1999, which analysis is made possible through tabular and spatial analysis of data gathered from the prisons which analyses the different parameters over time for the most hardened offenders. There are different categories of data covered in this chapter, inclusive of the 1950 to 1999 convicted offender data and the offences of those convicted offenders who were incarcerated during the period 1990 to 1999. Other data is extracted from the 1995 Census, welfare benefit data and other offence data.

### **8.1 Analysis of 'convicted' offender trends in Malta between 1950-1999**

This section attempts to draw up a picture of Maltese offenders, understand their background, and the type of crimes they commit. It then looks at where they reside in order to elicit common characteristics pertaining to their situation. It reviews data from 8,396 offenders who were incarcerated between 1950 and 1999. This includes a brief review of all incarcerated offenders and then focuses on the Maltese component. It seeks to establish who the Maltese offender is, what changes occurred over time, if any, and elicits any spatial issues that can be identified.

#### 8.1.1 Who is the offender in Maltese prisons?

Understanding the composition of offenders in Malta entails first separating the international



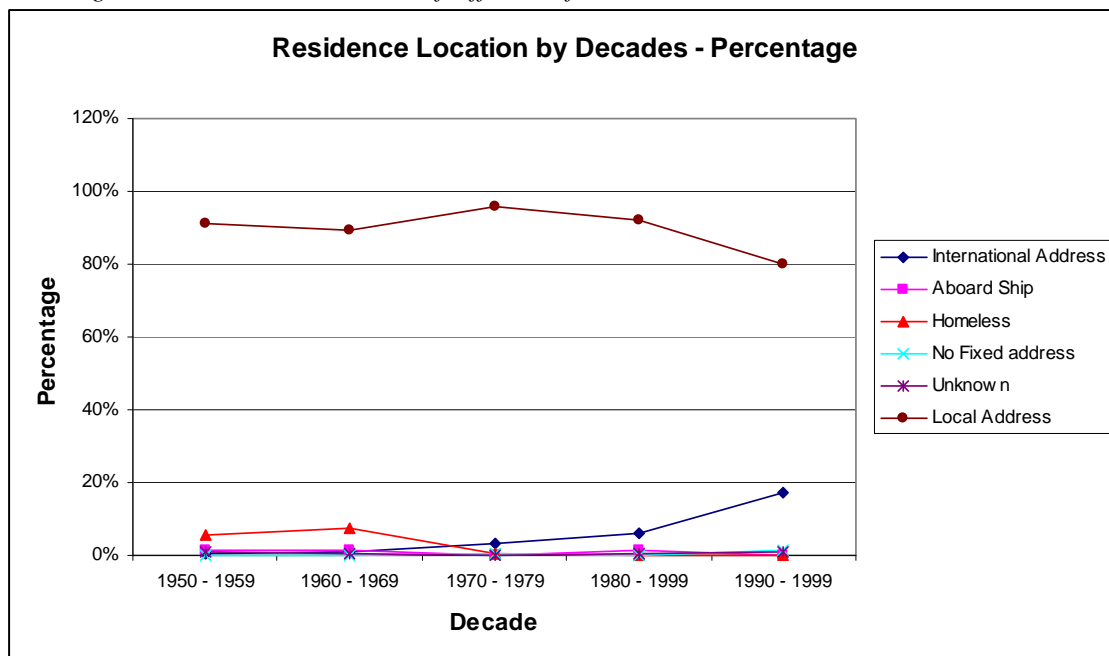
offenders from the local ones, and secondly separating the Maltese who have a locatable address from those that have no fixed address or are homeless<sup>151</sup>.

Table 8.1 indicates that the main offence categories can be split into two sections: the international and the local. The former are composed of the ‘international address’ and ‘aboard ship’ categories and are based on foreign inmates, whilst the other categories are composed of Maltese persons. The latter, in their majority (91.4% in the 1950s to 80.2% in the 1990s) have a known address. The rest either have no fixed address, are homeless or their residence is unknown. The table and Figure 8.1 show that there has been a steady decrease of local inmates since the 1970s with a corresponding increase in international inmates, which has reached over 17% in the 1990s.

*Table 8.1: Residence Location of Offenders from 1950 to 1999*

Residence Location for all Offenders by Sentence Decades												
	1950 - 1959		1960 - 1969		1970 - 1979		1980 - 1999		1990 - 1999		Total	
	Count	%	Count	%	Count	%	Count	%	Count	%	Count	%
<b>International Address</b>	17	0.6%	11	0.8%	39	3.2%	51	6.0%	381	17.1%	499	6.0%
<b>Aboard Ship</b>	39	1.5%	18	1.3%	2	0.2%	12	1.4%	0	0.0%	71	0.9%
<b>Homeless</b>	146	5.6%	104	7.7%	5	0.4%	0	0.0%	1	0.0%	256	3.1%
<b>No Fixed address</b>	0	0.0%	2	0.1%	6	0.5%	0	0.0%	36	1.6%	44	0.5%
<b>Unknown</b>	25	1.0%	9	0.7%	1	0.1%	4	0.5%	24	1.1%	63	0.8%
<b>Local Address</b>	2,401	91.4%	1,212	89.4%	1,176	95.7%	782	92.1%	1,785	80.2%	7,356	88.7%
<b>Total</b>	<b>2,628</b>	<b>100%</b>	<b>1,356</b>	<b>100%</b>	<b>1,229</b>	<b>100%</b>	<b>849</b>	<b>100%</b>	<b>2,227</b>	<b>100%</b>	<b>8,289</b>	<b>100%</b>

*Figure 8.1: Residence Location of Offenders from 1950 to 1999*



<sup>151</sup> Whilst the latter two categories can be analysed for their social data, spatial analysis is not possible. This categorisation facilitates the focusing of data analysis from a tabular structure to a spatial one, thus directing one to clarify which data can be analysed solely through tabular means as against those to which spatial statistics can be applied.

On the other hand, the homeless component has decreased since the 1960s, mainly due to a strengthening welfare system as well as a growing social accommodation structure.

Another point of note concerns the ‘no fixed address’ group that has grown over the decades indicating diverse issues: offenders either have no dwelling they call home or have multiple residences. They use this statement for diverse reasons, but primarily to make it difficult for an arrest warrant to be issued.

### **The foreign component**

As the foreign component is not analysed in depth in this study, a brief review shows that during the past five decades, Malta has had a varied composition in terms of its offenders. Offenders hail from a large number of countries as depicted in Figure 8.2, with differing composition over the decades.

*Figure 8.2: International Offender Source Country: 1950 to 1999*



The Maltese islands, having hosted the British colonial powers till 1964, saw its prisons welcoming a number of residents/dependents from that power, as evidenced by the 1950s with 96% of international offenders directly coming from England, Wales and Gibraltar, where the larger part were marked as being aboard Royal Navy ships when they committed an offence (Table 8.2). This decreased over time until the British garrison left in 1979. Subsequent ‘aboard ship’ offences were mainly tourism and/or merchant shipping related.

*Table 8.2: International Offender residence: the 1950s: percentage*

<b>International Offender 'Residence'</b>	<b>1950 - 1959</b>	<b>1960 - 1969</b>	<b>1970 - 1979</b>	<b>1980 - 1989</b>	<b>1990 - 1999</b>
Aboard Ship	71	62	5	19	0
England	22	3	10	6	1
Pakistan	4	0	0	0	0
Gibraltar	2	0	0	0	0
Wales	2	0	0	0	1

This situation was reversed in the later decades by a take-up of Arab foreigners, mainly Libyans who have dominated the prison scene since the 1970s, when the Maltese government sought closer ties towards the North African countries, particularly Libya. This component reached 25% during the 1990s (Table 8.3). In fact, North African offenders constituted 59% of all 1990s international prisoners, with 38% coming from the closest lands of Libya and Tunisia.

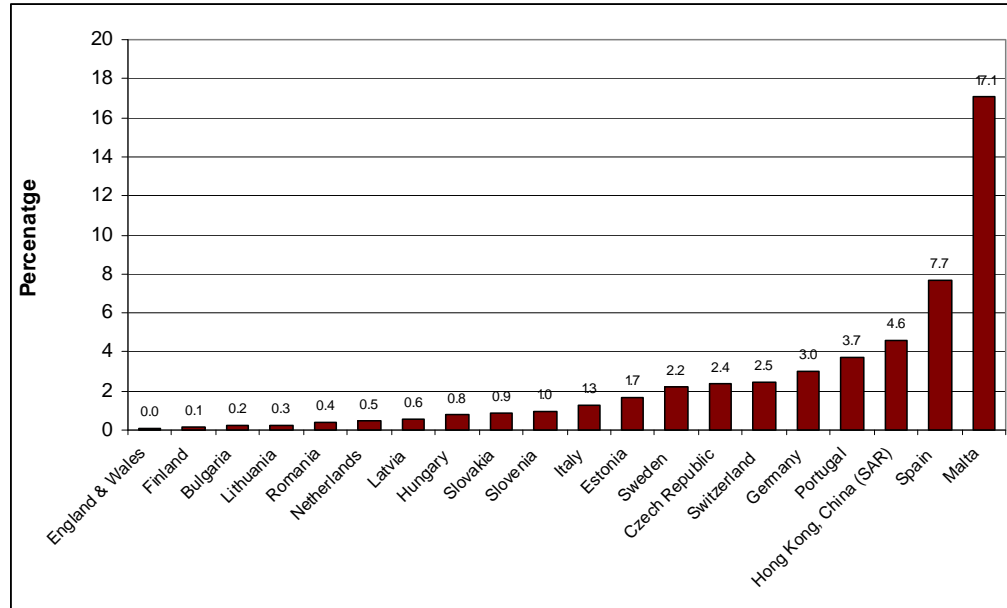
*Table 8.3: International Offender residence: the 1990s: percentage*

<b>International Offender 'Residence'</b>	<b>1950 - 1959</b>	<b>1960 - 1969</b>	<b>1970 - 1979</b>	<b>1980 - 1999</b>	<b>1990 - 1999</b>
Libya	0	0	20	13	25
Morocco	0	0	2	0	13
Tunisia	0	0	0	21	13
Nigeria	0	0	0	0	10
Ghana	0	0	0	10	8
India	0	0	0	3	8
Egypt	0	0	2	3	6
Algeria	0	0	5	2	2

Comparing the component to the global scene: a sub-study of the 1990s 17.1% foreign nationals in Maltese prisons indicates that this is definitely the highest both in Europe and in the only other island reporting comparative information: Hong Kong. Whilst the latter country registered an average of 4.6 percent of foreigners as a percentage of all incarcerated persons between 1998 to 2000, the highest in Europe was Spain with 7.7 %; less than half that of Malta (Figure 8.3). The other European countries show a mean of 1.63 without Malta's outlier and have varying percentages with the lowest being England and Wales at 0.05%.

Such data would be interesting to analyse against type of crimes that these persons commit, country of origin and sentence length. This would enable criminologists to analyse whether there is a marked distinction in sentencing practice based on country of origin, the difference in same-offence sentencing for foreigners and locals, as well as incarceration awards to the different groups.

Figure 8.3: Foreigners in Country Prisons as a percentage of total convicted 1998 – 2000 – an international perspective



Issues of ethnicity and race are rarely tackled in local studies due to the very small component of ethnic groups and denominations/sects in Malta. Little data exists on local groups to enable comparison of the prison offenders' background in relation to their compatriots living on the islands.

### The offender structure

With the international offender component put into perspective, it is time to elicit generic background data on convicted offender structure. Table 8.4 shows that the structure was made up mainly of male adults who were awarded long sentences (47.2%) and male adults serving short sentences (37.6%). The rest are split between young males (8.6%) and females (6.6%). The latter also comprises a very small young female component of 0.3%.

Table 8.4: Offender Sentence Categories – 1950s to 1990s

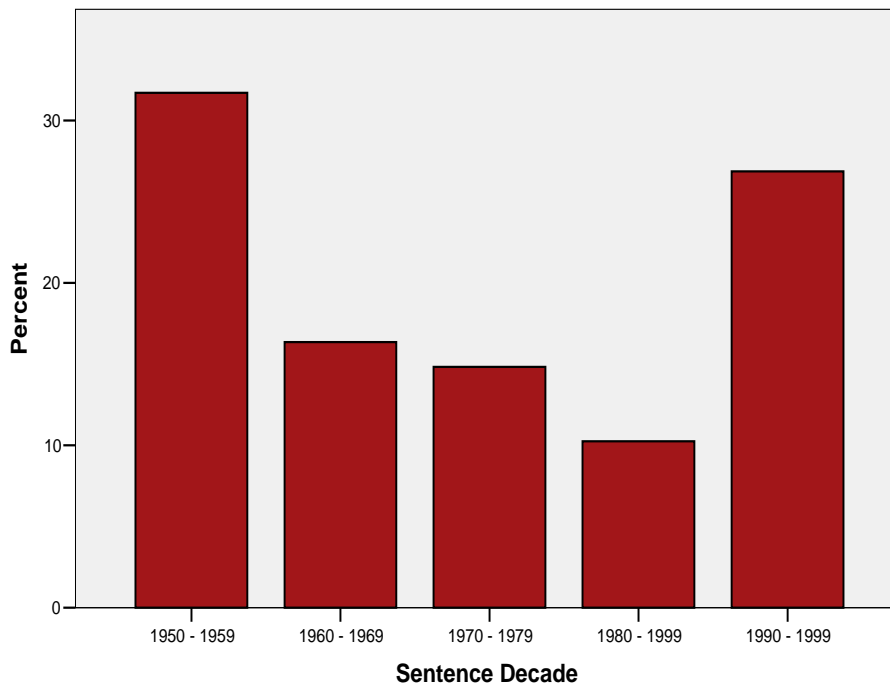
Category	Offenders	Percentage
Female Adult Long Sentence	130	1.5
Female Adult Short Sentence	400	4.8
Female Young Long Sentence	4	0.0
Female Young Short Sentence	21	0.3
Male Adult Long Sentence	3,962	47.2
Male Adult Short Sentence	3,156	37.6
Male Young Long Sentence	430	5.1
Male Young Short Sentence	293	3.5
<b>Total</b>	<b>8,396</b>	<b>100</b>

Of the 8,396 offenders incarcerated, 8,289 were designated a person-entry date. The figures show that the number of convicted offenders decreased rapidly between the 1950s and the 1960s, then continued to decrease slowly between the 1960s to the 1980s, except for a major upsurge in the 1990s. Table 8.5 and Figure 8.4 depict that the number of offenders in prisons has once again reached the 1950s level, which situation is quite alarming considering the steady decrease over the decades. This reflects the result of a culmination of events: new legislation, a more efficient sentencing system, an increasing crime rate and police/court closure of cases. Such a situation calls for deeper future analysis into the causes of the 1990s increase of convictions.

*Table 8.5: Offenders in prisons – 1950s to 1990s*

	<b>Frequency</b>	<b>Valid Percent</b>
1950 - 1959	2628	31.7
1960 - 1969	1356	16.4
1970 - 1979	1229	14.8
1980 - 1989	849	10.2
1990 - 1999	2227	26.9
Total	8289	100.0

*Figure 8.4: Offenders in prisons – 1950s to 1990s*



With the generic data covered, the study shall now focus on the Maltese convicted offender analysis.

## Summary of the Offender Structure

In summary, the Maltese prisons host one of the highest relative international components in Europe, steadily increasing over the decades whilst changing in character from a UK-based structure in the 1960s to a Northern African one on the 1990s. In terms of structure, male adults dominate the scene, mainly incarcerated for long sentences closely followed by short sentences. The female component is quite low. Incarceration in Malta has declined over the decades but has also seen a resurgence in the 1990s.

### 8.1.2 Who is the Maltese offender?

Is there an established profile for the Maltese offenders? Can one attempt to create such a profile? Does it change over time and what are the main characteristics that highlight the Maltese offender's profile? Such questions spring to mind when no information exists on the structure of the offender, as is the case in the Maltese islands.

This section attempts to answer these questions through an analysis of a series of parameters that progressively explore the main social components. The process analyses age, social issues as are education and employment. It then reviews other crime-related issues such as recidivism and seriousness of crimes committed by the Maltese offender.

The study is tackled through a series of research questions eliciting information on offenders. Each section is preceded by the research question being analysed.

#### The age parameter

This section investigates the age component of the convicted Maltese offender to try to elicit an understanding of the changing age structure, if any.

*Research Question: Do younger age cohorts have higher crime rates?*

The Maltese offender is young, aged between 21-30 years old (37.2% of all offenders), with the younger groups indicating that 1.5% of offenders are of school age with 17.2% aged between 17-20 years. The older the cohorts, the smaller the percentage component, dwindling from 19.1% for the 31-40 year cohort down to 7.6% for the 51-60 year cohort. A Pearson Chi-Square test of  $\chi^2$  of 1200.067 and  $p = 0.000$  (Table 8.6) shows that there is a significant relationship between age cohorts and convictions over the decades thereby proving the hypothesis. The results show

that there was a concentration of convicted offenders toward the middle cohorts with a reduction over the decades at the extremes and an increase in the 21-30 year cohort (from 22.6% in the 1950s to 49.7% in the 1990s) with a smaller increase in the 31-40 year cohort.

*Table 8.6: Crosstabulations and Chi-Square Tests for Age Cohorts and Convictions over the Decades*

**Age Cohorts \* Sentence Decade Crosstabulation**

			Sentence Decade					Total
			1950 - 1959	1960 - 1969	1970 - 1979	1980 - 1989	1990 - 1999	
Age Cohorts	Less than 10	Count	1	0	0	0	0	1
		% within Sentence Decade	.0%	.0%	.0%	.0%	.0%	.0%
	11 to 16	Count	72	20	14	9	10	125
		% within Sentence Decade	2.7%	1.5%	1.1%	1.1%	.5%	1.5%
	17 to 20	Count	504	225	317	143	234	1423
		% within Sentence Decade	19.2%	16.6%	25.8%	16.9%	10.6%	17.2%
	21 to 30	Count	593	423	553	412	1102	3083
		% within Sentence Decade	22.6%	31.2%	45.0%	48.6%	49.7%	37.3%
	31 to 40	Count	406	253	161	183	580	1583
		% within Sentence Decade	15.5%	18.7%	13.1%	21.6%	26.2%	19.1%
41 to 50	Count	485	193	130	69	219	1096	
	% within Sentence Decade	18.5%	14.2%	10.6%	8.1%	9.9%	13.2%	
51 to 60	Count	352	156	39	26	57	630	
	% within Sentence Decade	13.4%	11.5%	3.2%	3.1%	2.6%	7.6%	
61 to 70	Count	159	78	15	5	13	270	
	% within Sentence Decade	6.1%	5.8%	1.2%	.6%	.6%	3.3%	
71 plus	Count	55	8	0	1	1	65	
	% within Sentence Decade	2.1%	.6%	.0%	.1%	.0%	.8%	
Total		Count	2627	1356	1229	848	2216	8276
		% within Sentence Decade	100.0%	100.0%	100.0%	100.0%	100.0%	100.0%

**Chi-Square Tests**

	Value	df	Asymp. Sig. (2-sided)
Pearson Chi-Square	1200.067 <sup>a</sup>	32	.000
Likelihood Ratio	1258.533	32	.000
Linear-by-Linear Association	290.562	1	.000
N of Valid Cases	8276		

Figure 8.5 gives a clear depiction of this phenomenon, which can be explained through instances in better care provision at the younger age groups over the decades, where courts try to lessen the option to incarcerate as against providing care, whereas at the higher age groups the reduction is due to such social improvements as eradication of begging and homelessness, which constituted the main bulk of these cohorts' misdeeds. Thus, over time, the percentage of extreme-end cohorts has been taken up by serious cases and consequently the middle age group has been impacted with the relative increase.

A spatial analysis of offenders in the 21-30 year cohort, during the 1990s, shows that young offenders live in very specific areas. Figure 8.6 shows that they are mainly centered within the conurbation enumeration areas (EAs) with specific concentrations in the Grand Harbour Region and in such ‘new’ areas as San Pawl il-Bahar and Marsascala.

Figure 8.5: Offenders' Age Cohorts – 1950s to 1990s

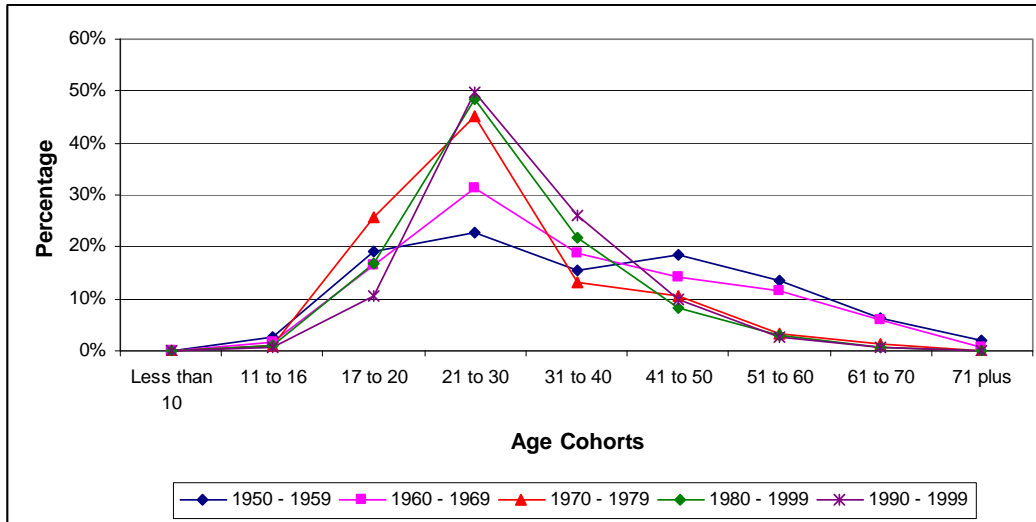
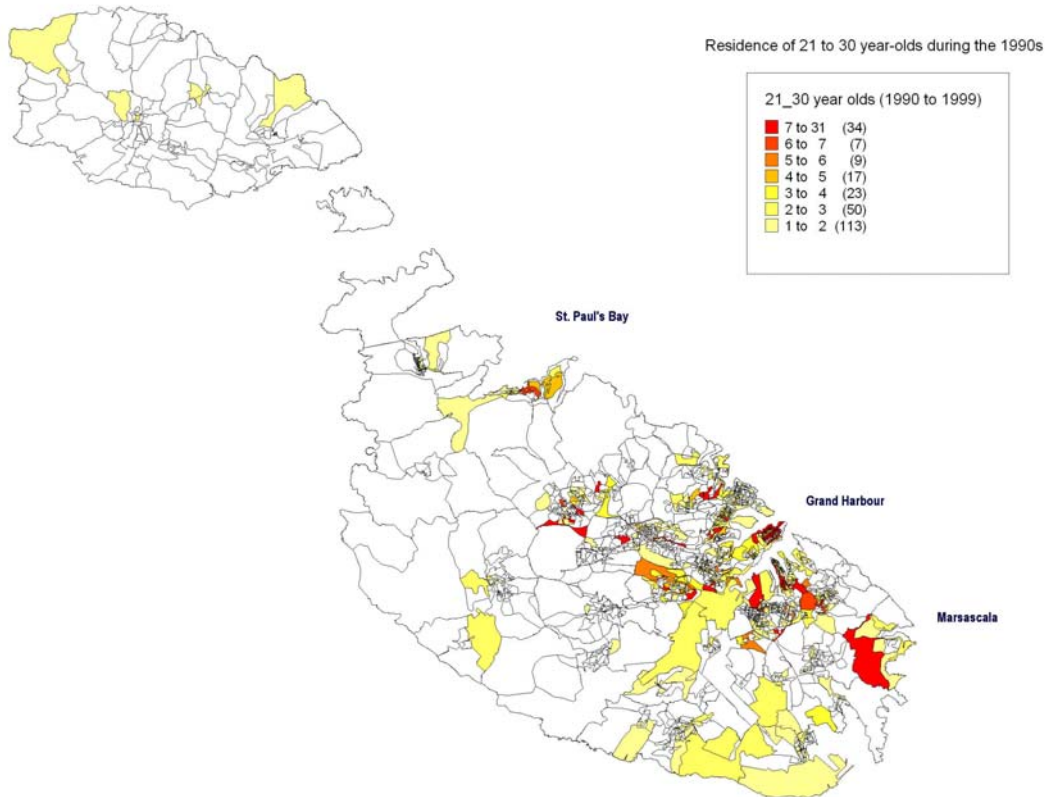


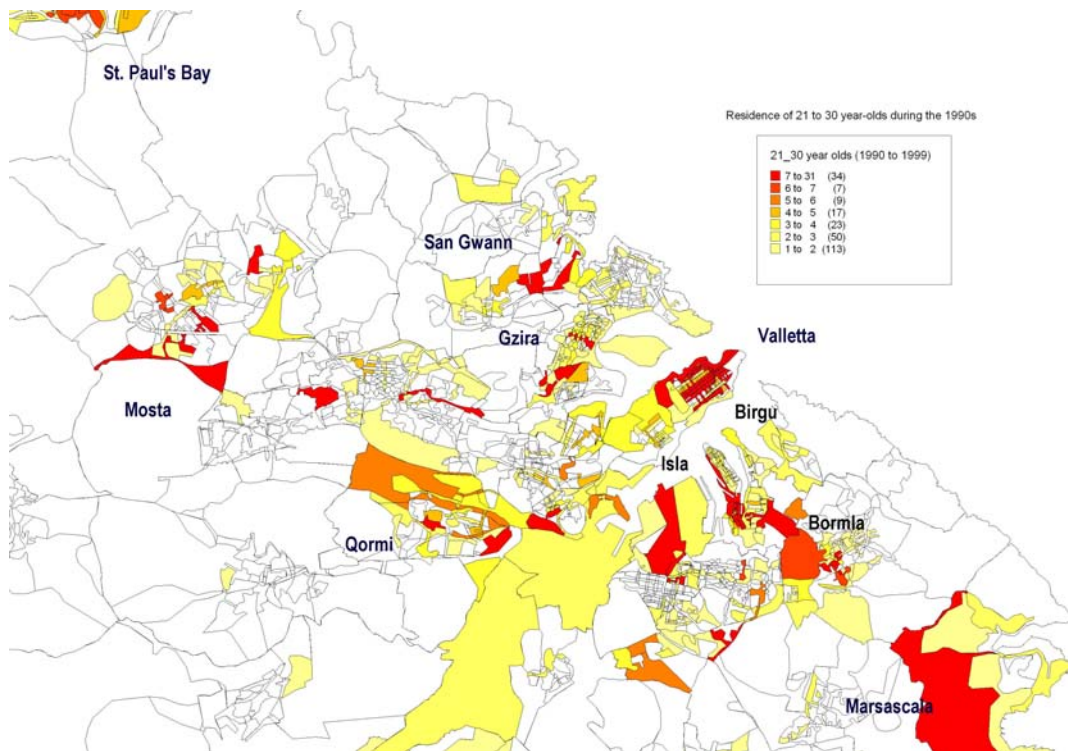
Figure 8.6: Spatial location of offenders in the 1990s





A further zooming in as depicted in Figure 8.7 shows that at local council level, the main councils harbouring these offenders include the old cities of the Grand Harbour (Valletta and the Three Cities of Birgu, Bormla and Isla), the towns of Qormi and Gzira as well as the relatively new towns of Marsascala, San Pawl il-Bahar, Mosta and San Gwann, where the latter towns have seen rapid expansion in their housing provision.

*Figure 8.7: Spatial location of offenders in the 1990s – Detail*



### The social parameters

This section looks at the offenders' marital status and educational issues to try and ascertain whether they have a common background (refer to research question below). Educational status is based on literacy (ability to read and write) and school level achieved<sup>152</sup>, whilst marital issues is based on both status and the number of children born to this group. The analysis for these variables is based on unique prisoner data<sup>153</sup> so that double counting of recidivist cases is eliminated.

*Research Question: Do offenders have a common social background ?*

<sup>152</sup> As described in the prison ledgers.

<sup>153</sup> One single instance for each offender was chosen.

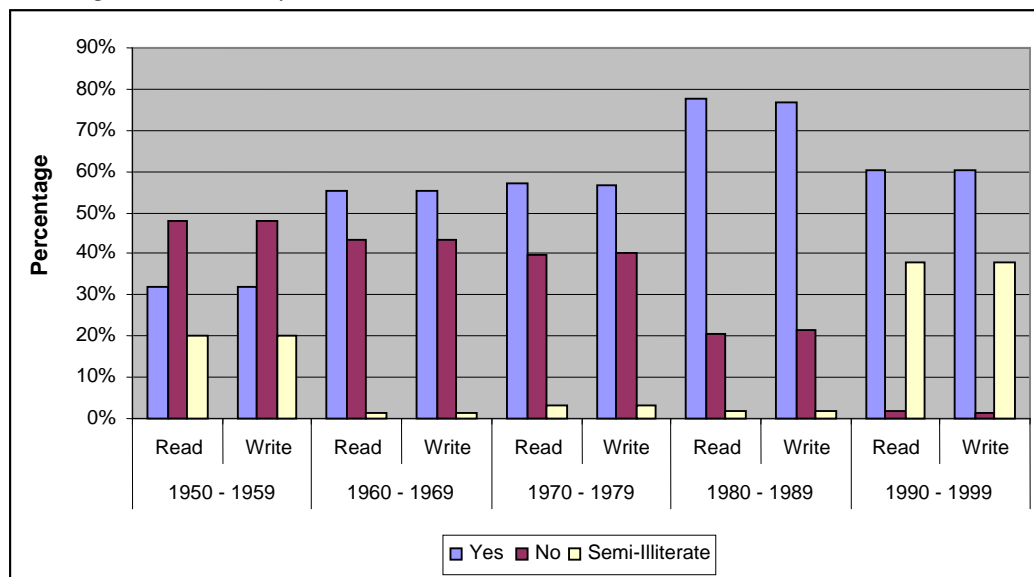
### The educational parameter: literacy

Analysing educational background against offender data over the decades indicates that offenders have achieved higher levels of education over time, through increased attendance at school. This was based on the introduction of compulsory education in the 1950s. However, such may not reflect directly to achievement of educational qualification. The ability to read and write has increased in parallel (see Figure 8.8 bar heights) over the decades with very high rates of change over the decades particularly the 1970s to 1980s which period saw a 20% jump in literacy. However, the analysis also indicates a large reduction in literacy between the 1980s and 1990s of 17% and a relative increase of 36% for persons now deemed to be semi-literate (Table 8.7).

Table 8.7: Literacy of known offenders: 1950 - 1999

	1950 - 1959		1960 - 1969		1970 - 1979		1980 - 1989		1990 - 1999		Total	
	Read	Write	Read	Write	Read	Write	Read	Write	Read	Write	Read	Write
Yes	32.20%	32.20%	55.30%	55.40%	56.90%	56.50%	77.70%	76.90%	60.30%	60.40%	52.00%	51.90%
No	47.80%	47.80%	43.40%	43.30%	39.70%	40.10%	20.60%	21.40%	2.00%	1.50%	32.00%	32.00%
Semi-Illiterate	20.00%	20.00%	1.30%	1.30%	3.30%	3.30%	1.60%	1.60%	37.70%	38.00%	16.00%	16.00%

Figure 8.8: Literacy: 1950 - 1999



Such a situation can be the result of redefining literacy to include both read and write capacity, an increasing non-Maltese component that does not have the knowledge of the Roman alphabet and persons who do not speak Maltese or English. Figure 8.8 shows the apparent explosion of yellow bars during the 1990s as against the practically eradicated inability to read and write (in purple). When compared to the national data, which indicated a 88% literacy in the 1985 Census

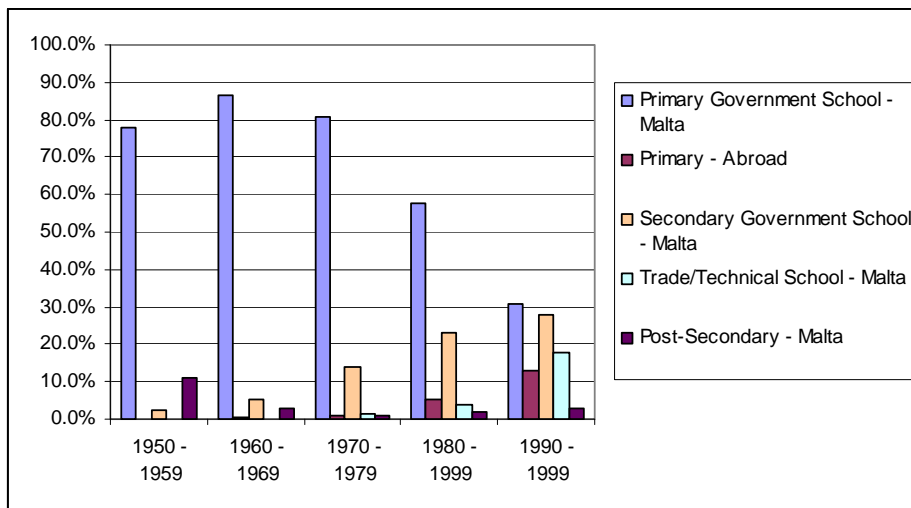
and a similar figure in 1995, the prison population registers a lower than average educational level.

### The educational parameter: highest school level achieved

An analysis of the offender's highest educational level achieved can be carried out through the highest level of schooling completed or when the offender left school.

Crosstab results (Table 8.8) show that there is a significant relationship of  $p=0.000$  between type of schooling and offenders over time<sup>154</sup>. The analysis in Figures 8.9a&b indicates that there has been a drastic change in the educational levels of local offenders who had the most basic of primary education: down to 30.8% in the 1990s from 77.8% in the 1950s. Whilst school attendance is compulsory in Malta till age 16 when secondary level is concluded, there are still a large number of persons who fall through the net and leave before reaching 16 years of age. Offenders have a high percentage falling within this group indicating they stop schooling at the primary level. The 30.8% figure compares well with the 1995 Census national figure of 33% for this group. However, the primary school component is once again increasing in prisons due to the fact that foreign offenders also have a high rate within this group (12.8%).

Figure 8.9a: School level achieved amongst known offenders: 1950 – 1999 (highest school categories)



As described, compulsory education includes the secondary level, which is verified by the increasing number of offenders at this level, reaching 27.7% in the 1990s, to which should be added the vocational (trade and technical) group of 17.8%. The latter were aggregated in schools sometimes through trade choice and sometimes as fallout of a highly competitive system where

<sup>154</sup> Note: unique offender names were used to eliminate double counting of same persons, in effect this calculation focuses only on the schooling they had on first incarceration

the low-achievers were siphoned off into schools such as the so-called Opportunity Centres. This resulted in very high absenteeism and absconding rates that only increased any potential offender's opportunity to learn a dark trade, rather than being tutored by the social guardians at school. The national data shows that 41% and 9% achieved secondary and vocational levels respectively. This means that the prison population has a lower than national average of its secondary component, however there is a very high rate of persons who had attended vocational schools, in fact twice the national average.

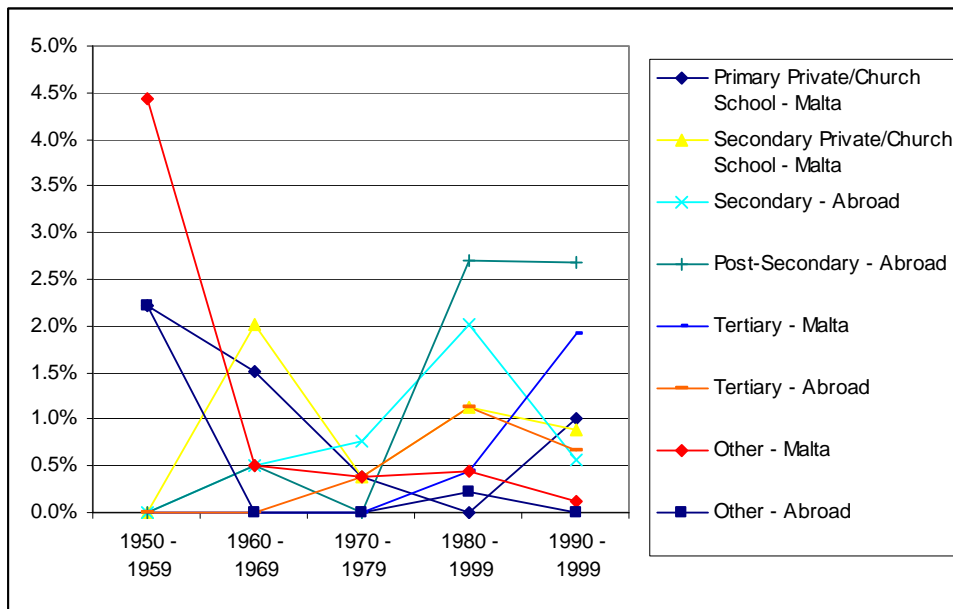
*Table 8.8: Crosstabulations and Chi-Square Tests for type of schooling and known offenders over time*

			Sentence Decade					Total
			1950 - 1959	1960 - 1969	1970 - 1979	1980 - 1989	1990 - 1999	
School_Type	Other - Abroad	Count	1	0	0	1	0	2
		% within Sentence Decade	2.2%	.0%	.0%	.2%	.0%	.1%
	Other - Malta	Count	2	1	1	2	1	7
		% within Sentence Decade	4.4%	.5%	.4%	.4%	.1%	.4%
	Post-Secondary - Abroad	Count	0	1	0	12	24	37
		% within Sentence Decade	.0%	.5%	.0%	2.7%	2.7%	2.0%
	Post-Secondary - Malta	Count	5	6	2	9	27	49
		% within Sentence Decade	11.1%	3.0%	.8%	2.0%	3.0%	2.7%
	Primary - Abroad	Count	0	1	3	24	114	142
		% within Sentence Decade	.0%	.5%	1.1%	5.4%	12.8%	7.7%
	Primary Government School - Malta	Count	35	171	211	256	275	948
		% within Sentence Decade	77.8%	86.4%	80.5%	57.5%	30.8%	51.5%
	Primary Private/Church School - Malta	Count	1	3	1	0	9	14
		% within Sentence Decade	2.2%	1.5%	.4%	.0%	1.0%	.8%
	Secondary - Abroad	Count	0	1	2	9	5	17
		% within Sentence Decade	.0%	.5%	.8%	2.0%	.6%	.9%
	Secondary Government School - Malta	Count	1	10	36	102	247	396
		% within Sentence Decade	2.2%	5.1%	13.7%	22.9%	27.7%	21.5%
	Secondary Private/Church School - Malta	Count	0	4	1	5	8	18
		% within Sentence Decade	.0%	2.0%	.4%	1.1%	.9%	1.0%
	Tertiary - Abroad	Count	0	0	1	5	6	12
		% within Sentence Decade	.0%	.0%	.4%	1.1%	.7%	.7%
	Tertiary - Malta	Count	0	0	0	2	17	19
		% within Sentence Decade	.0%	.0%	.0%	.4%	1.9%	1.0%
	Trade/Technical School - Malta	Count	0	0	4	18	159	181
		% within Sentence Decade	.0%	.0%	1.5%	4.0%	17.8%	9.8%
Total		Count	45	198	262	445	892	1842
		% within Sentence Decade	100.0%	100.0%	100.0%	100.0%	100.0%	100.0%

**Chi-Square Tests**

	Value	df	Asymp. Sig. (2-sided)
Pearson Chi-Square	515.062 <sup>a</sup>	48	.000
Likelihood Ratio	557.023	48	.000
Linear-by-Linear Association	156.814	1	.000
N of Valid Cases	1842		

Figure 8.9b: School level achieved amongst known offenders: 1950 – 1999 (lowest school categories)



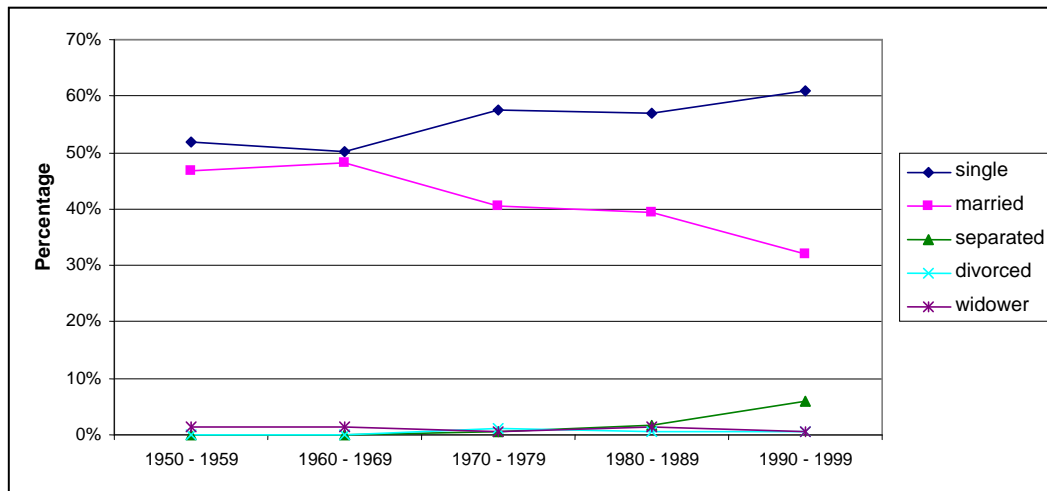
Interestingly, a new group of residents have made their way into prison; those with a tertiary education, mainly in the fields of homicide, fraud and drugs, amongst others, though these are one-offs. The figure of 1.9% is very low compared to a 9% national component for this group.

### The status parameter: Marital and children

Looking at marital status helps to identify the type of offender Malta hosts, which section shows that offenders are increasingly single or separated, rising from 51.9% in the 1950s to 66% in the 1990s (Figure 8.10). Married offenders have declined from 46.8% to 32.10%, indicating a reduction in cohesion and the ability to return to some kind of family group. Such an individualistic situation renders the offender to seek other forms of cohesion, which could be based on peer groups, composed of similarly minded persons, thus increasing the risk for re-offending, though such a statement requires qualitative research.

As for the number of children of offenders these have gradually gravitated toward single child (33.4%) to 2 children (30.6%) in the 1990s from 3 to 4 in the 1950s. These figures are in effect lower than the national Census figures (36.4% and 41.7% respectively), however whilst this stands to reason that the number of children is growing less, at the same time the age representation in prison is also growing younger thus, the latter may be the main cause of such a decline.

Figure 8.10: Marital status: 1950 - 1999



In summary, each of these social parameters indicates a homogenous offender group that exhibits distinct characteristics from similar national cohorts, strengthening the research question of a common social background.

### The employment parameter

In order to understand the offenders' social structure, an analysis of the relationship between their location of residence and poverty is required. This would elicit an understanding of the offender's world: where he lives, the poverty status of those areas, his/her relationship with the areas in terms of offence, and the social makeup of such areas. For the purpose of this study poverty is analysed through the use of a surrogate: unemployment. The latter serves as the basis for choices an offender may make to partake to crime, depending on his/her need to acquire finances to survive or improve his/her 'relative poverty' through non legal means.

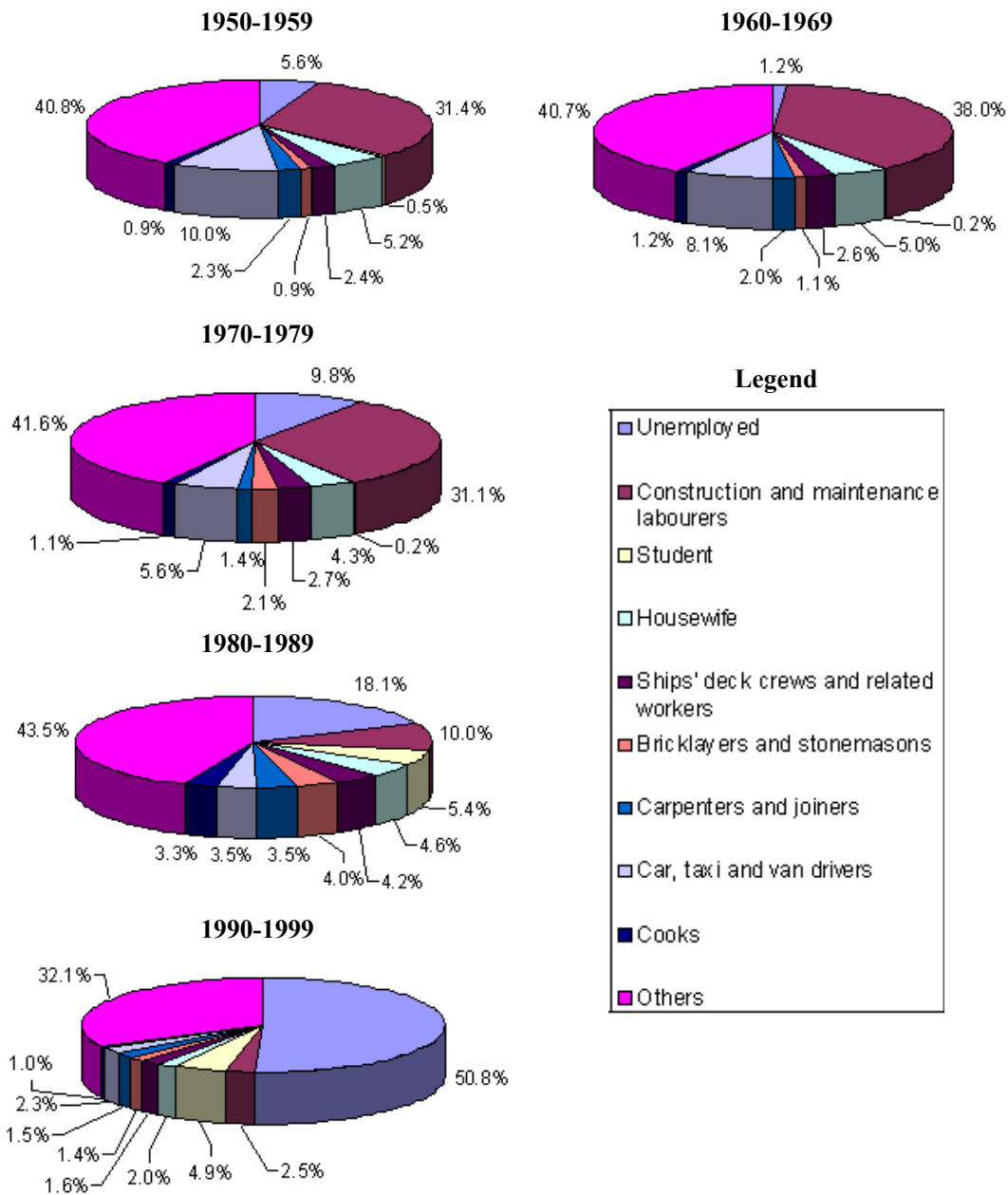
Before going on to analyse poverty and social relationships (tackled later in this chapter), it is essential to understand what employment and unemployment structures exist within the offenders' dataset. This is carried out through an International Standard Classification of Occupations (ISCO) analysis of all offenders over the 1950-1999 period which prepares the way for the 1990-1999 analysis as this period is the one that can analysed against both social and landuse data.

*Research Question: Do offenders have similar employment (unemployment) characteristics?*

As per component structure, the results (Figure 8.11) show that the main group of offenders are unemployed, which group grew from 5.6% in the 1950s to 50.8% in the 1990s. The latter figure can be compared to Table 5.5 that shows a 5% national unemployment in 2005, which result

indicates a huge discrepancy between both groups. The 50.8% unemployed figure for the 1990s can be compared to the UK which reaches 67%<sup>155</sup> of all prisoners (and 63% for young prisoners) in 2005. Such indicates a very volatile situation where most of the persons in prison are young and unemployed, a situation that does not augur well considering that they would have very little chance of employment once released, either due to reluctance to work, as well as bias and 'fear of relapse' by employers.

Figure 8.11: Known offender employment categories based on ISCO: 1950 – 1999



155

<http://www.crimeinfo.org.uk/servlet/factsheetservlet?command=viewfactsheet&factsheetid=54&category=factsheets>

Figure 8.11 also shows the other main homogenous types of offenders in prison over the decades such as construction-related workers, students, ship crews, housewives and taxi-drivers. The rest classed under 'others', though considerable in number incorporate all the other occupation types that were either individually too small to form a distinct group or are made up unique professions/occupations.

The most 'popular' 10 categories in the employment list indicate that the second-largest category is the 'construction and maintenance labourers', which though only 10% in the 1990s, had declined from 38% in the 1960s. Another group that saw a major change between the decades was the drivers group that decreased from 10% in the 1950s to 3.5% in the 1990s. These figures can be reviewed against a national component of 8.1% for construction and 6.8% for labourers in 2005 as depicted in Table 5.6. Such figures support the research question's hypothesis that offenders do have common employment characteristics.

### **The recidivism parameter**

Offenders, particularly those who lean towards making a career from crime, fall within a recidivist sub-category that calls for deeper research into their activity background.

*Research Question: How common is recidivism and to what extent is it restricted to a limited number of individuals?*

The Maltese Islands are not immune to recidivism and an analysis shows that over the five decades under study 60 percent (4,930) of convicted persons were recidivists. This is a very high rate and in line with the UK's 80% for juveniles and 60% for adults in 2004<sup>156</sup>. More detailed analysis of this offender category (Figure 8.12) shows that 29.6% were first time recidivists, 14.9% second-time recidivists, 9.9% third time recidivists and a very large 45.6 % over-3-times recidivists. A breakdown of the latter shows that whilst 31.2% of all offenders have been incarcerated between 4 and 10 times, a few undoubtedly break any records at re-conviction, with 5 persons registering 39 incarcerations, of whom 3 of them had 55 records, 2 had 61 of which the record goes to one male sentenced and incarcerated for 67 times and counting to date!

In addition, 2.4% of recidivists had started quite early, since they had been incarcerated under Article 23CC that covered the Ex-Approved School legislation, which school served as a juvenile prison.

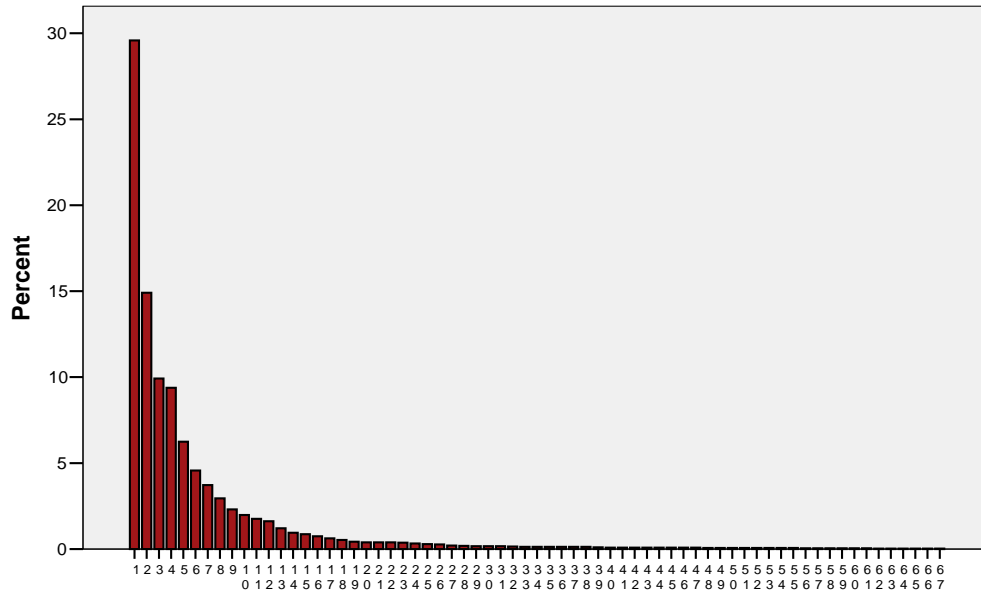
---

<sup>156</sup> <http://www.ditchley.co.uk/page/125/prisoner-reintegration.htm>, accessed 28 June 2007: A Note by the Director (Ditchley 2004/05) – 'Prisoner reintegration: its place in modern policing and correctional systems'. 26-28 March 2004



Such figures give support to the question of high recidivism rates but show that the number of recidivists is very high and not limited to a few individuals.

Figure 8.12: Recidivism instances: 1950 - 1999



Recidivism Instances

Table 8.9: Crosstabulations and Chi-Square Tests for recidivism and time

**f\_r\_Convic ^ Sentence Decade Crosstabulation**

			Sentence Decade					Total
			1950 - 1959	1960 - 1969	1970 - 1979	1980 - 1989	1990 - 1999	
f_r_Convic	First Offender	Count	757	463	606	488	965	3279
		% within Sentence Decade	29.2%	34.7%	49.5%	57.8%	44.2%	40.1%
	Recidivist	Count	1839	872	618	356	1219	4904
		% within Sentence Decade	70.8%	65.3%	50.5%	42.2%	55.8%	59.9%
Total		Count	2596	1335	1224	844	2184	8183
		% within Sentence Decade	100.0%	100.0%	100.0%	100.0%	100.0%	100.0%

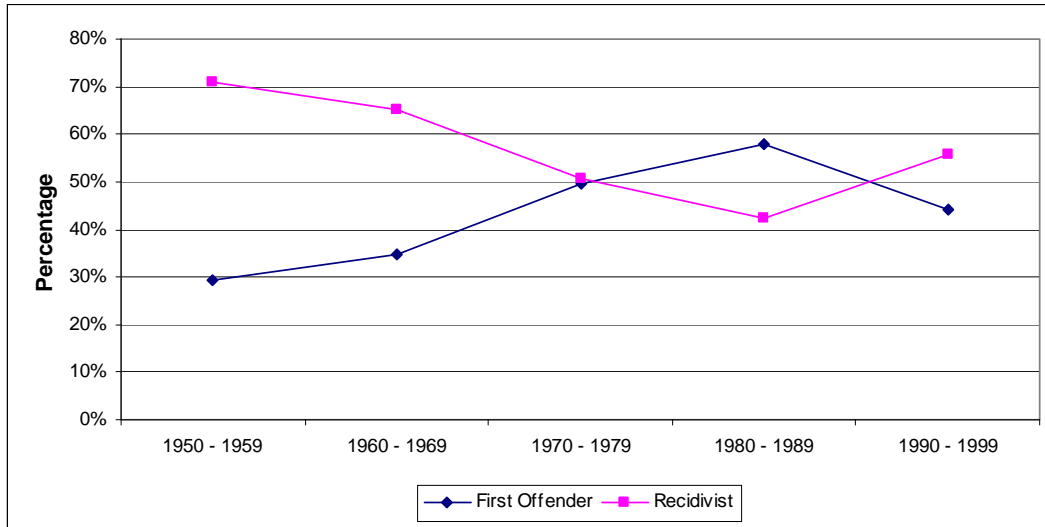
**Chi-Square Tests**

	Value	df	Asymp. Sig. (2-sided)
Pearson Chi-Square	316.358 <sup>a</sup>	4	.000
Likelihood Ratio	317.976	4	.000
Linear-by-Linear Association	184.987	1	.000
N of Valid Cases	8183		

A Chi-squared test (Table 8.9) shows that there is a significant relationship of  $p=0.000$  between recidivism and time at  $\chi^2$  of 316.358. This is highlighted through an analysis of change over time where the structure of recidivists changed drastically from the early decades to recent times. First

time offenders were in a minority during the early decades with 70.8% being recidivists which gap decreased gradually until the 1970s were the two groups coincided (Figure 8.13). This trend continued during the 1980s when first-timers outnumbered the recidivists at a ratio of 3:2. However the trend reversed itself during the 1990s with recidivists totalling 55.8% of the prison population.

Figure 8.13: Recidivism categories: 1950 - 1999



A Crosstabs analysis of recidivism by age groups (Table 8.10) shows that there is a significant relationship of  $p=0.000$  between recidivism and age at  $\chi^2$  of 404.808, due to a higher probability of recommitting an offence over time. The most interesting function of this categorisation relates to the age when the critical point from first offender to recidivist occurs. The result of the correlation identifies the 17-20 year cohort as the switching age (Figure 8.14).

Table 8.10: Crosstabulations and Chi-Square Tests for recidivism and age

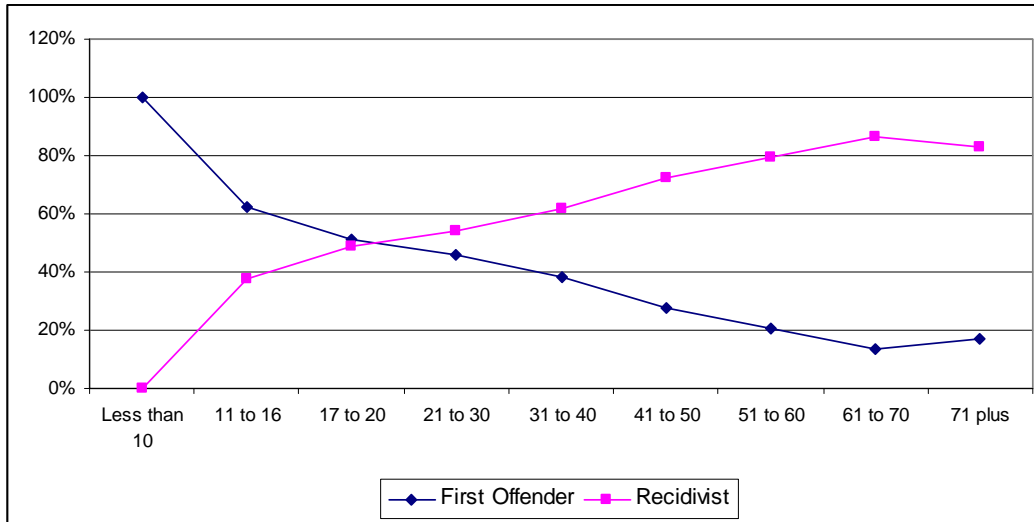
f\_r\_Convic \* Age Cohorts Crosstabulation

Count	Age Cohorts									Total	
	Less than 10	11 to 16	17 to 20	21 to 30	31 to 40	41 to 50	51 to 60	61 to 70	71 plus		
f_r_Convic											
First Offender	Count	1	78	728	1406	594	297	127	37	11	3279
	% within Age Cohorts	100.0%	62.4%	51.2%	45.9%	38.1%	27.7%	20.5%	13.7%	16.9%	40.0%
Recidivist	Count	0	47	694	1654	967	777	494	233	54	4920
	% within Age Cohorts	.0%	37.6%	48.8%	54.1%	61.9%	72.3%	79.5%	86.3%	83.1%	60.0%
Total	Count	1	125	1422	3060	1561	1074	621	270	65	8199
	% within Age Cohorts	100.0%	100.0%	100.0%	100.0%	100.0%	100.0%	100.0%	100.0%	100.0%	100.0%

**Chi-Square Tests**

	Value	df	Asymp. Sig. (2-sided)
Pearson Chi-Square	408.808 <sup>a</sup>	8	.000
Likelihood Ratio	432.975	8	.000
Linear-by-Linear Association	400.101	1	.000
N of Valid Cases	8199		

Figure 8.14: Recidivism age cohorts: 1950 - 1999



An analysis of recidivists' offences indicates that re-offenders tend to commit relatively fewer crimes per category in which they originally offended, except for increases in such offences as violence, theft and generic offences. As an example violence was indicated at 3.9% to 5.8% in the first and second instances respectively. In addition, most re-offenders hail from Valletta, followed by Paola and Qormi, which fall within the highest 11 localities that report incidences of crime (refer to Table 8.16 and Chapter 9, Table 9.7)

Figure 8.15: Poverty Map of the Grand Harbour region: 2003

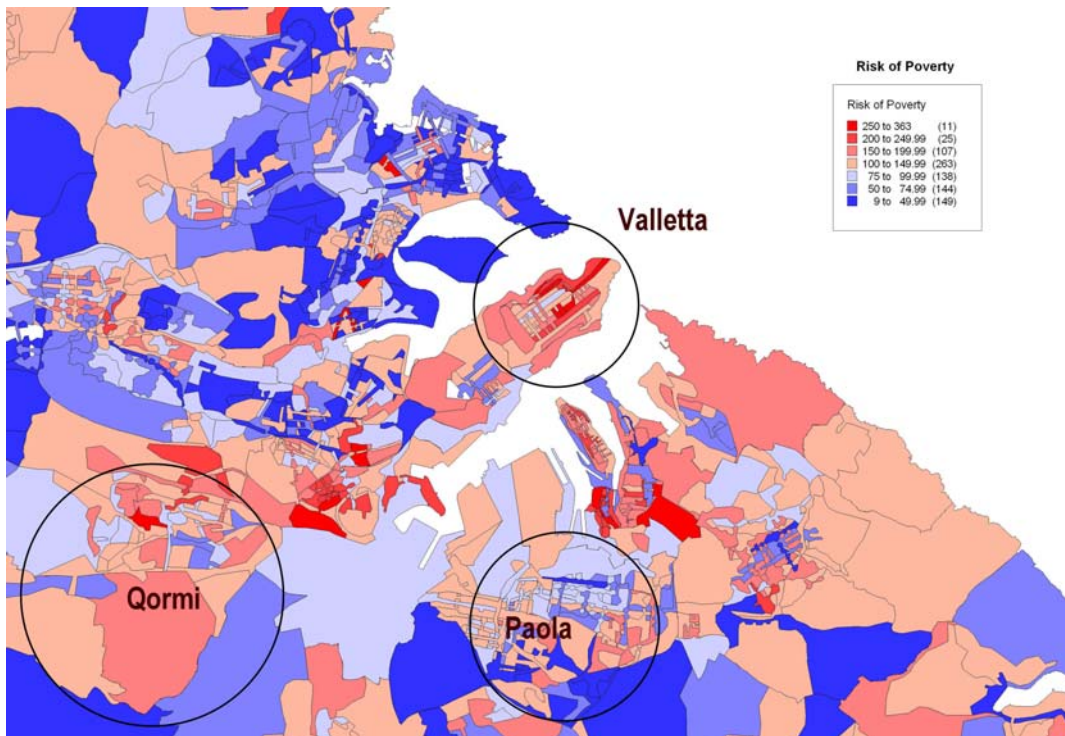


Figure 8.15 also describes the areas that register more than 1.5 (pink) to 3.5 (red) times the national poverty rates for 2003 (the methodology is described further in the chapter). Whilst Valletta registers the highest rates of poverty, most areas of Qormi register high rates of poverty whilst Paola registers less rates. It is interesting to note that these 3 localities make up part of the Grand Harbour and its immediate suburbs. Other towns in the region have high rates of poverty but not necessarily high rates of recidivism. These issues require further investigation.

### **The seriousness parameter**

Having analysed how offenders changed over time, the next link in understanding them is to look at the offences they commit. This enables one to understand the type of crime committed and whether the offences change in seriousness over time.

*Research Question: Are offences committed by known offenders becoming more serious over time?*

Analysis results show that offences have increased in seriousness over the decades mainly serious crime that increased from the 1950s to the 1980s from 20.4% to 44.2% with a slight decrease to 31.3% in the 1990s. The main increases occurred in homicides which tripled in the first four periods whilst drugs shot up from 0.1% in the 1960s to 14.6% in the 1990s. Table 8.11 lists the offences committed by these offenders by category, whilst Figure 8.16a depicts the serious and non-serious category totals, which mainly highlights the peaking of serious crimes during the 1980s and a relative dipping of non-serious crime during the same period. Figure 8.16b shows the changes in serious crime over time.

Non serious crime generally saw a decline in crime rates except for other offences that had been declining since the 1950s (79.6%) to 55.8% in the 1980s. They jumped again to those levels during the 1990s (68.7%) amongst which a spurt of petty theft and pick pocketing.

Table 8.11: Crimes by seriousness: 1950 - 1999

	1950 - 1959	1960 - 1969	1970 - 1979	1980 - 1989	1990 - 1999
Homicide	1.5%	1.3%	2.7%	4.5%	2.0%
Drugs offences		0.1%	5.0%	9.7%	14.6%
Violence against the person	0.6%	0.9%	1.1%	2.3%	1.1%
Serious wounding	1.9%	2.9%	2.2%	3.7%	3.1%
Serious and slight wounding	3.8%	2.1%	2.7%	1.9%	1.3%
Sexual offences	8.9%	11.5%	7.4%	3.9%	4.7%
Robbery	3.7%	1.6%	11.2%	18.2%	4.6%
<b>Total Serious</b>	<b>20.4%</b>	<b>20.5%</b>	<b>32.3%</b>	<b>44.2%</b>	<b>31.3%</b>
Other violence	6.6%	5.0%	5.4%	3.1%	2.1%
Common assault	1.0%	1.5%	1.9%	1.2%	2.0%
Burglary dwelling	0.9%	0.3%	1.0%		0.6%
Burglary other	0.2%	0.1%			0.5%
Vehicle crime	0.5%	2.4%	1.6%	0.2%	3.0%
Other theft	21.0%	26.8%	18.1%	16.3%	8.1%
Theft from Shop, Retail, Leisure and Recreation Areas					0.1%
Criminal damage	2.2%	2.2%	1.8%	1.0%	1.1%
Fraud and forgery	2.3%	4.1%	3.0%	5.6%	5.2%
Other offences	44.7%	36.1%	34.6%	27.9%	45.9%
Attempted offences	0.2%	0.9%	0.2%	0.4%	0.1%
<b>Total Non-Serious</b>	<b>79.6%</b>	<b>79.5%</b>	<b>67.7%</b>	<b>55.8%</b>	<b>68.7%</b>

Figure 8.16a: Crimes by seriousness: 1950 - 1999

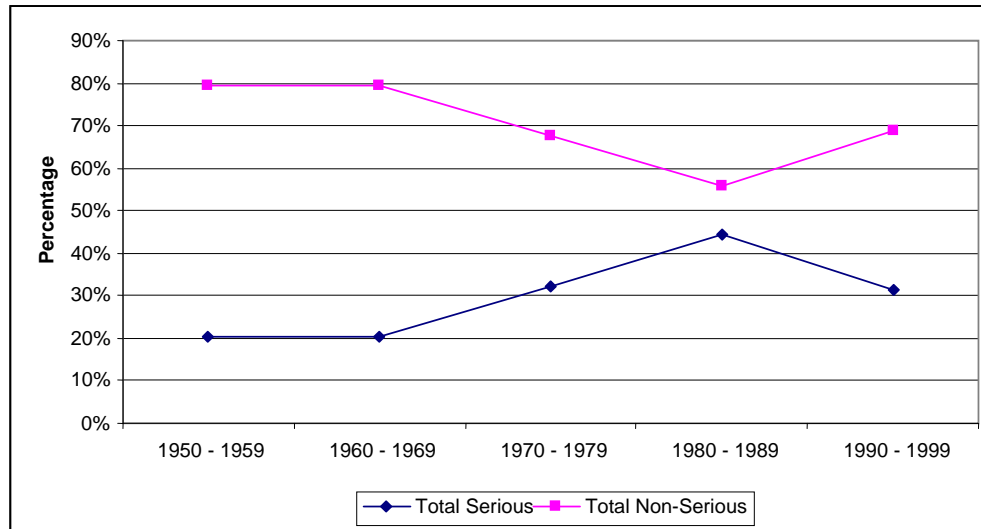
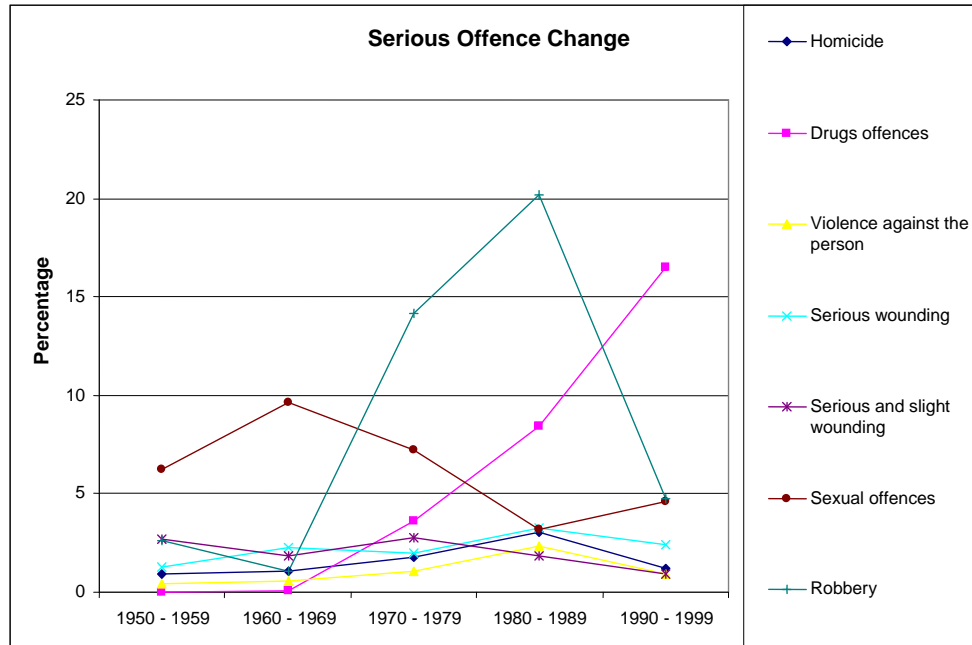


Figure 8.16b: Serious crimes: 1950 - 1999



Taking these figures further, one can identify that the main age cohort responsible for these offences falls within the 21-30 years that has a 32.9% take-up of all the violent crimes committed in the Maltese Islands, followed by the 31-40 year olds and declining over the other age groups.

### Summary of the Maltese Offender profile

At a stage where the Maltese offender has been categorised, a basic profile would show that the offender in Malta's prisons is male, aged between 21 and 30 years old, a recidivist, is increasingly less literate and being replaced by semi-illiterate offenders, has had a secondary education mainly in government and trade/opportunity schools, is single, unemployed and increasingly partaking to serious crimes.

The analysis shall now strive to analyse the residential location that the offenders live in, in terms of spatial and physical parameters. The data will concentrate on both a five-decade analysis as well as the 1990s data when required for detailed analysis. The section investigates the issues of offender residence in specific areas, as well as the issues of regionalisation and residential migration over the decades. Such an analysis aids the researcher to understand the dynamics of the offender's background. This will aid the later analysis of poverty and landuse.

### 8.1.3 Where does the Maltese offender live?

#### **The Conurbation, Cities, Village Cores and Housing Estates**

In an attempt to analyse where offenders live, a spatial approach is taken concentrating on the largest urban area structure and progressively working towards the smaller spatial units. This section looks at the relationship between the offender residence working down from the conurbation to the city/town type to the old areas known as Urban Conservation Areas and Village cores and eventually to the Housing Estates and where possible to the Enumeration Areas.

*Research Question: To what extent do offenders live in concentrated areas such as the old cities, village cores, Housing Estates, etc.?*

#### **The Conurbation**

The Maltese conurbation stretches from Zabbar in the South to Naxxar in the North and Attard in the West. An analysis on offender location was carried out using spatial statistics. Figure 8.17 shows the result of a spatial clustering exercise run using CrimeStat III's Spatial Distribution tool which produced a Standard Deviational Ellipse (SDe) at 1 standard deviation<sup>157</sup>. The data source was based on all the mapped 1990s known offenders residential locations and the ellipsoid generated on the 2,227 points<sup>158</sup>. The figure shows that the main offender location hotspot ellipsoid is centered around the conurbation, whilst a 2 standard deviation ellipsoid covers both the conurbation and its suburbs.

An analysis of the composition of offenders was stable in the 1950s (80.6%) and 1960s (79.3%) in both the conurbation and the suburbs (Table 8.12). This situation changed during the 1970s with more offenders moving into the conurbation reaching up to 72% with a corresponding decrease in the suburbs (13%). The next decade, in turn saw a decline in both areas which continued up to the 1990s resulting with a 60% composition in the conurbation and 9% in the suburbs. The rest were dispersed in the extra-conurbation areas that were released for

---

<sup>157</sup> 68% of cases within a normal distribution would fall within one standard deviation of the mean. In the case of two standard deviations, 95% of the cases would be catered for (Levine, 2002: Pg 2.15).

<sup>158</sup> Standard Deviational Ellipse: (1X) with a Sample size: 2227, Measurement type: Direct – result - Clockwise angle of Y-axis rotation.: 81.775692 degrees and Ratio of long to short axis: 2.0103, SD along new Y axis: 5694.64 m, SD along new X axis: 11448.20 m, Y axis length: 11389.29 m, X axis length: 22896.41 m, Area of ellipse: 204811243.24 sq m. The Standard Deviational Ellipse (2X): SD along new Y axis: 11389.29 m, SD along new X axis: 22896.41 m, Y axis length: 22778.58 m, X axis length: 45792.81 m, Area of ellipse: 819244972.96 sq m.

development from the late 1970s to the 1990s, which areas eventually took up 30% of all offenders.

Figure 8.17: Conurbation Standard Deviation Ellipse at 1NNH and 2NNH

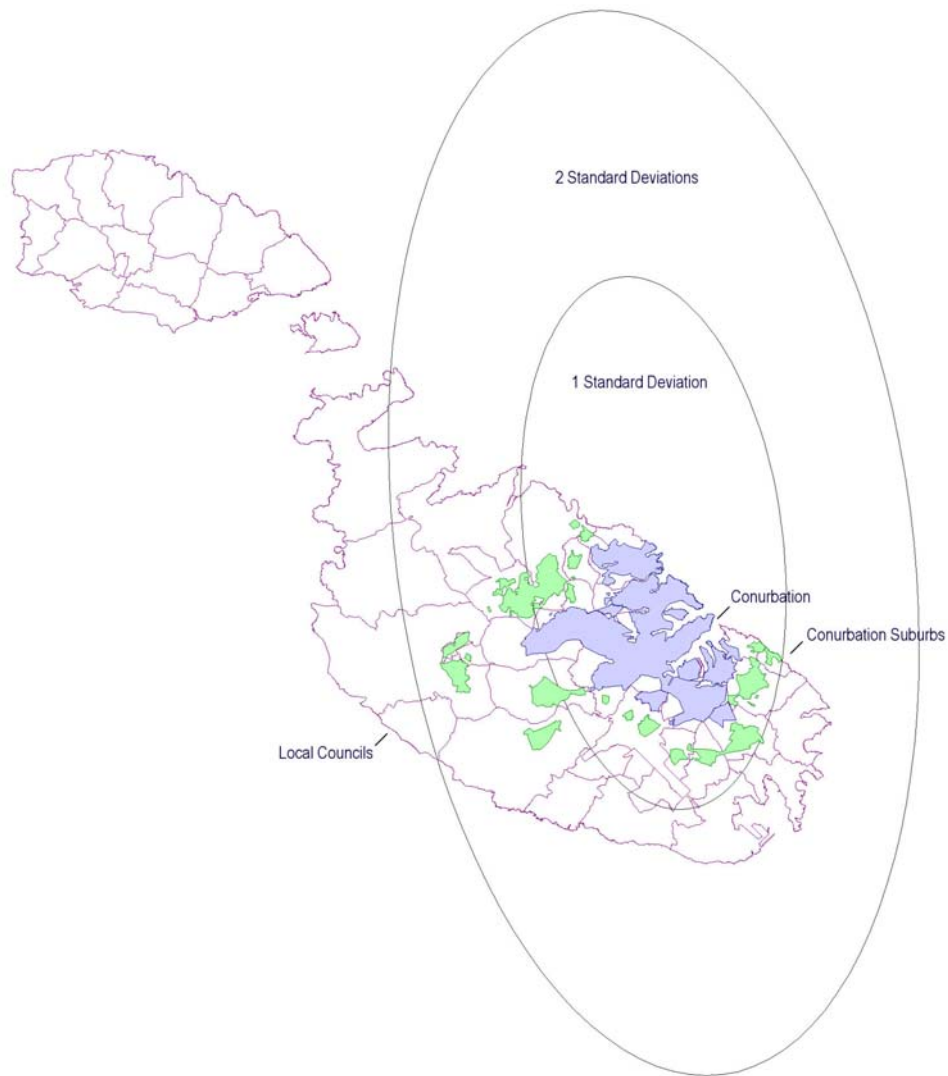


Table 8.12: Offenders' residence in the conurbation: 1950 - 1999

	Conurbation	Suburb	Total Offenders	% in Conurbation	% in Suburb	Total in Conurbation & Suburbs
1950 to 1959	1637	482	2628	62	18	80.6
1960 to 1969	833	242	1356	61	18	79.3
1970 to 1979	885	165	1229	72	13	85.4
1980 to 1989	568	115	849	67	14	80.4
1990 to 1999	1347	210	2227	60	9	69.9
No Date	18	4	107	17	4	20.6
<b>Total</b>	<b>5270</b>	<b>1214</b>	<b>8396</b>	<b>63</b>	<b>14</b>	<b>77.2</b>



## The Cities and Towns

At a more detailed NUTS 5 level, an analysis of offender residence shows that offenders used to live in the main towns during the early decades with a gradual loss in this category by one third which loss was mainly taken up by the suburbs and the seaside resorts (Table 8.13). These areas increased in size during the post-war period which situation allowed for internal migration that further dispersed the offender population as well as creating new areas to which offenders migrated or where new residents turned to crime. On the other hand, the historic cities exhibit a unique structure in that they initially increased their offender component and have practically maintained a quarter of the group over the decades.

Interesting to note is the fact that during the 1990's 20 percent of offences did not have an actual spatial location since they were committed either on a ship or on a plane.

*Table 8.13: Offenders' residence in the cities and towns: 1950 - 1999*

Percentage Load	Historic City	Seaside Town and City	Suburb	Town	Village	Others	Total on land
1950 to 1959	19	10	4	49	10	9	91
1960 to 1969	23	8	7	44	8	11	89
1970 to 1979	31	7	4	46	8	4	96
1980 to 1989	27	8	8	37	12	8	92
1990 to 1999	26	11	5	33	6	20	80
No Date	8	5	0	9	4	74	26
<b>Total</b>	<b>24</b>	<b>9</b>	<b>5</b>	<b>42</b>	<b>8</b>	<b>12</b>	<b>88</b>

## The Urban Conservation Areas and Village Cores (UCA\_VC)

From the analysis of spatial aggregations, the UCA\_VC is one of the most interesting in that there is a major change in offender residence that is highly indicative of the changes that the Maltese Islands went through in their urban sprawl frenzy and the subsequent depopulation of the cores. The UCA\_VC had a load of 74% in the 1950s of all offenders within their boundaries, only to see it eroding away over successive decades until the 1990s registered only 46.7% (Table 8.14). There was only a slight increase in the 1970s, again dropping back to 1960s level. Whilst this issue may indicate a positive reduction of crimes in the areas, it also indicates a general haemorrhage of the urban cores that is also reflected in general population loss such as the loss of over half of the population of the Grand Harbour historical cities since 1948. In turn, it also indicates a potential dispersion of offenders to other areas.

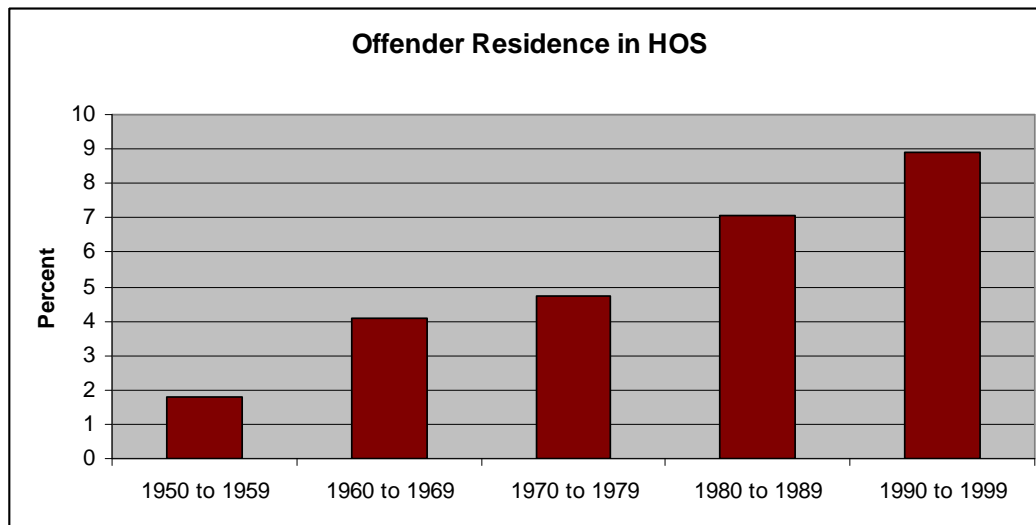
Table 8.14: Offenders' residence in the UCA and Village Cores: 1950 - 1999

	UCA & Village Core	Total Offenders	% in UCA & Village Core
1950 to 1959	1946	2628	74.0
1960 to 1969	943	1356	69.5
1970 to 1979	951	1229	77.4
1980 to 1989	566	849	66.7
1990 to 1999	1040	2227	46.7
No Date	25	107	23.4
<b>Total</b>	<b>5446</b>	<b>8396</b>	<b>64.9</b>

### The Housing Estates (HOS – Home Ownership Schemes)

One final spatial aggregate that calls for offender residence analysis concerns the government distributed Home Ownership Schemes (HOSs). These areas were distributed for free to the public for development purposes and have to a certain extent also developed into a magnet for offenders, particularly due to very-low-rent accommodation availability. In fact the areas in question saw an increase from 1.8% offenders living in those areas prior to the HOS awarding land, to 8.9% in the 1990s (Figure 8.18).

Figure 8.18: Offences in the HOSs: 1950 - 1999



In summary, over time, offenders have declined in the conurbation, historic cities and towns, whilst increasing in such areas as seaside towns and housing estates showing a preference to move into the newer as against the older localities.

## A Spatial Analytical Construct

Following the analysis of different spatial aggregates, the next phase aimed to analyse the offender residence against the NUTS 4 districts and NUTS 5 and more detailed spatial analyses that would help elicit the movement of offenders over time. Such an argument is based on a perennial assumption among the Maltese population that offenders live in the South of Malta.

*Research Question: Is there a North-South-Gozo divide in offender residence or does it occur at regional level?*

### Step 1: The Regional Analysis: NUTS 4

The first phase of analysis takes the results one step up to a regional perspective based on a NUTS 4 spatial construct. The results, as shown in Table 8.15 indicate that of the 7,353 offenders in Maltese prisons who could be given land-based residential spatial coordinates, the main concentrations are not centered towards the South of Malta but around a totally different structure; that based around the harbour region in the east. The Northern and Southern Harbour regions account for nearly 75% of all offenders which figure remained stable at around 29% for the northern part and the southern part of the harbour registering around 43% of the load. This drastic difference from the other districts is accentuated in Figure 8.19 which shows that all the other districts put together (totalling 25.6%) would not even reach the levels of the lesser of the first two. Figure 8.20 shows a spatial depiction of the districts in question, clearly outlining the two main harbour districts.

*Table 8.15: Percentage Offenders by Region sorted by 1950-1999 data*

District	1950 to 1959	1960 to 1969	1970 to 1979	1980 to 1989	1990 to 1999	Total
Gozo and Comino	4.4	3.0	4.3	3.2	2.3	3.5
Northern	5.5	4.5	2.6	4.9	8.9	5.6
Northern Harbour	34.8	28.8	28.3	31.3	29.9	31.3
South Eastern	11.3	12.5	10.8	11.8	6.5	10.3
Southern Harbour	36.8	43.0	49.4	41.6	48.9	43.4
Western	7.3	8.3	4.5	7.3	3.6	6.1
<b>Total</b>	<b>100%</b>	<b>100%</b>	<b>100%</b>	<b>100%</b>	<b>100%</b>	<b>100%</b>

Figure 8.19: Percentage Offenders by Region sorted by 1950-1999 data

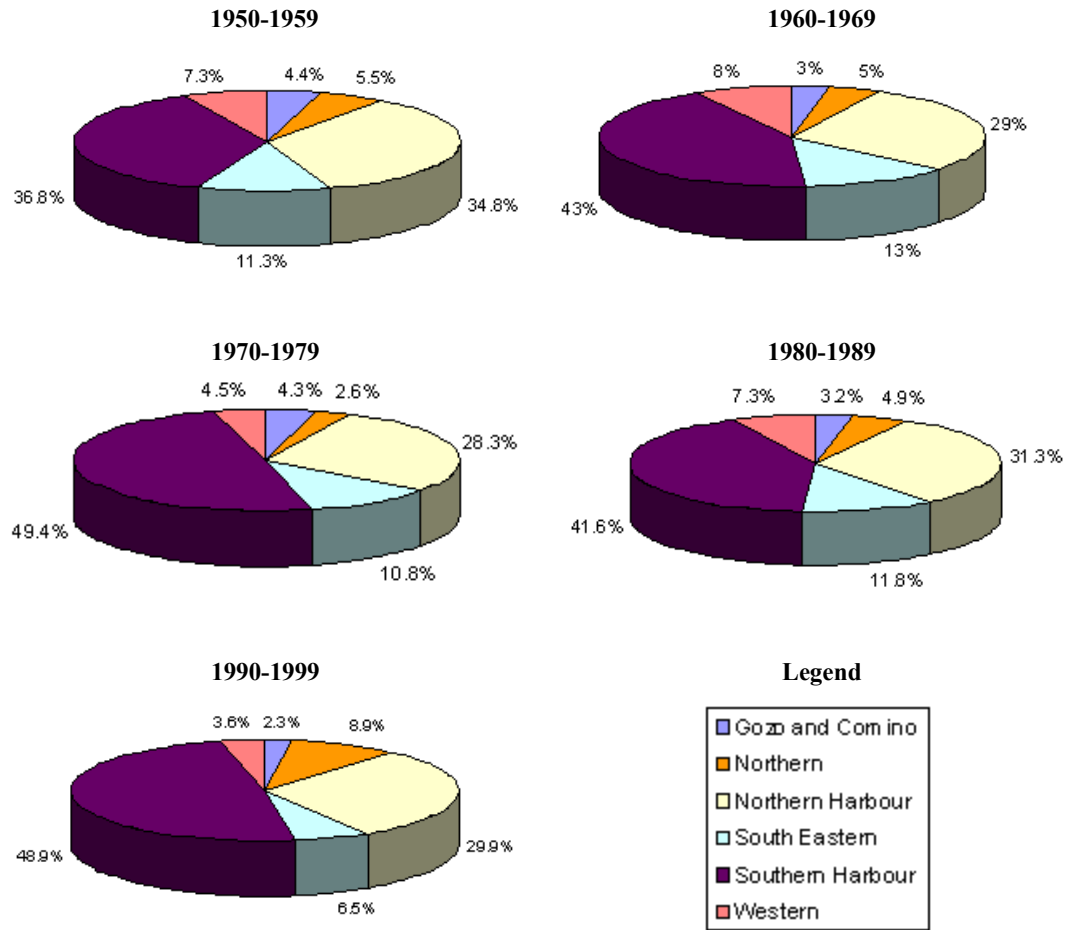
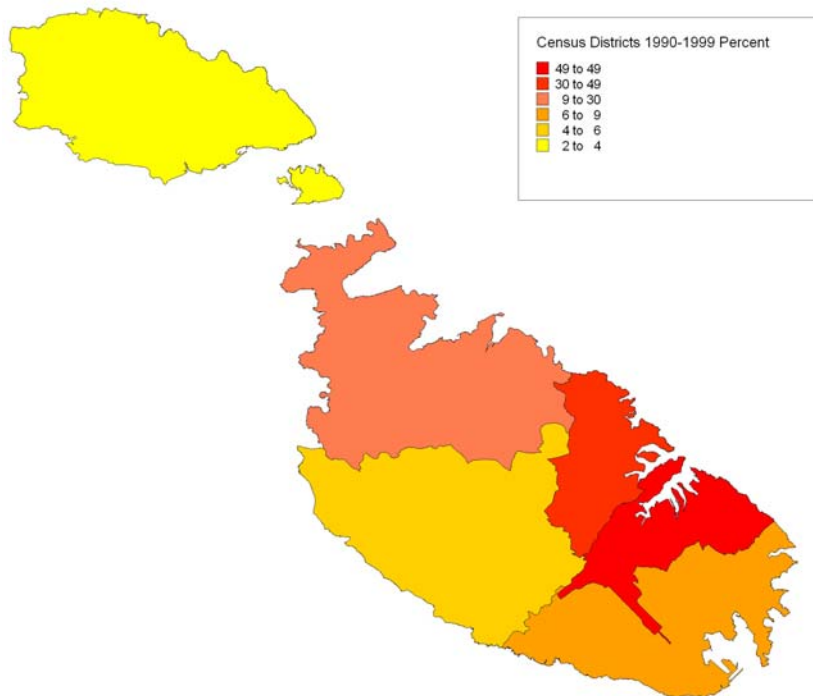


Figure 8.20: Percentage Offenders by Region sorted by 1990-1999 data - map



## Step 2: The Locality Analysis: NUTS 5

Research Question: Are offenders in any one area disproportionately concentrated compared with that area's share of the total population?

This is analysed through a review of the NUTS 5 localities and how their offender component varied over the decades sorted by 1990s' results (Table 8.16). The results show that the highest offender-hosting locality during the 1990s was Bormla (one of the Three Cities – grey rows) which pole position was also registered during the 1980s. However, this was not always the case, as Valletta, which came a close second in the 1980s and 1990s had been the highest in the previous three decades reaching 17.4% during the 1970s. This indicates that once tipped, it is very difficult to undo that status as was so very evident in Bottoms *et al's* (1989) Gardenia case. Furthermore, the entire ancient harbour cities fall within the top third localities hosting offenders in Malta whilst Xaghra (yellow row) was the Gozitan locality hosting the highest number of offenders, albeit at 0.7%.

The above initial analysis indicates that the spread of the top 10 localities does not necessarily centre on the southern areas but is dispersed over a much larger area that calls for further analysis to help direct the identification of offender-residence areas. This said, a closer look at the data as depicted in the Table 8.16 Change attributes (*Offender % Change 1980s - 1990s* and *Population % Change 1980s - 1990s*) of both offender and population categories for the 1980s to 1990s period leads to some surprising results that focuses the need to research in more detail eventual take-up of the large part of offenders by the top-contender councils.

Table 8.16 shows that the top four plus one councils hosting the highest percentage of offenders (Bormla, Valletta, Qormi and Gzira in the Grand Harbour vicinity and San Giljan to the North) between them hosted 32.6% of offenders in the 1980s going up to 41.6% in the 1990s. At the same time their population share has decreased from 15.6% to 12.2% of the total population. Whilst the other councils show various combinations of offender-population concentrations, the resultant concentration of 41% in so few localities indicates that there is a compound problem in terms of both population and offender concentrations. The offender percentage in the top areas is increasing very rapidly irrespective of population change, however when one considers that should the population increase, such does not automatically warrant a value-added attraction for offenders from the localities to initiate their activity or others to move-in. Thus, the inverse situation as currently identified in the above finding is of major concern; the indicated areas are becoming hotspots for offender concentrations, pointing to Bottoms *et al's* (1989) "Gardenia" tipping situation.

This finding needs to be further researched to identify which are the causes and the eventual effect or whether both variables feed on each other. The causes can be various: depopulation from the old cities and the suburbs, increase in unliveable retail-induced conditions as seen in San Giljan, amongst others. Such issues are compounded by opportunities for persons who could include offenders to squat and move into cheaper rental areas such as the case in Valletta. Other issues that need to be studied include statistically-stable populations that experience transient movements, but could be detrimental to cohesion.

Table 8.16: Percentage Offenders and Population by Locality sorted by 1950-1999 data and change 1980s-1990s: NUTS 5 ...cont

Locality	Offender % 1950 to 1959	Offender % 1960 to 1969	Offender % 1970 to 1979	Offender % 1980 to 1989	Offender % 1990 to 1999	Offender % Change 1980s - 1990s	Population % Census 1957	Population % Census 1967	Population % Census 1985	Population % Census 1995	Population % Change 1980s - 1990s
Bormla	6.3	5.4	9.3	11.1	14.2	Increasing	2.8	2.9	2.2	1.6	Decreasing
Valletta	10	11.8	17.4	9	12.7	Increasing	5.7	4.9	2.7	1.9	Decreasing
Qormi	5.3	5.1	3.8	5	5.8	Increasing	4.7	4.9	5.3	4.7	Decreasing
Gzira	2.4	3.4	4	5.2	5.3	Increasing	2.7	3.1	2.5	2.1	Decreasing
Birkirkara	7.6	5.5	5.6	5.4	3.9	Decreasing	5.3	5.5	5.9	5.6	Decreasing
Zabbar	2.9	2.2	2.8	1.9	3.6	Increasing	3.4	3.3	3.7	3.7	Increasing
San Giljan	1.3	1.7	2	2.3	3.6	Increasing	2.6	2.4	3.0	1.9	Decreasing
San Pawl il-Bahar	0.8	0.2	0.4	0.6	3.5	Increasing	1.0	0.9	1.3	2.0	Increasing
Fgura	0.1	1.3	1.1	0.9	2.9	Increasing	0.0	0.0	2.4	2.9	Increasing
Marsa	3.4	3.9	5.1	4.6	2.9	Decreasing	3.3	3.1	2.3	1.4	Decreasing
Mosta	2.5	2.3	0.8	1.8	2.7	Increasing	2.3	2.7	3.5	4.4	Increasing
Hamrun	6.7	3.9	2.4	3.6	2.7	Decreasing	5.3	4.7	4.0	3.0	Decreasing
Paola	4.5	3.1	5.7	2.4	2.5	Increasing	3.6	3.8	3.4	2.5	Decreasing
Isla	1.3	2.4	2.4	5.9	2.5	Decreasing	1.6	1.5	1.2	0.9	Decreasing
Sliema	5.2	1.7	3.5	3.5	2.4	Decreasing	7.3	6.7	4.1	3.4	Decreasing
San Gwann	0.1	0.2	0.8	1.8	1.9	Increasing	0.0	0.7	2.4	3.2	Increasing
Santa Lucija	0	0.2	1	0.6	1.9	Increasing	0.0	0.0	0.9	1.0	Increasing
Naxxar	1.1	1	0.6	1	1.8	Increasing	1.5	1.5	1.9	2.6	Increasing
Birgu	1.3	4.2	1.2	2.3	1.8	Decreasing	1.3	1.3	1.0	0.8	Decreasing
Birzebbugia	1.6	2.5	0.7	1.4	1.6	Increasing	1.7	1.6	1.6	1.9	Increasing
Marsascala	0.2	0.7	0	0.3	1.3	Increasing	0.3	0.3	0.6	1.3	Increasing
Tarxien	1.8	1.4	1	0.6	1.3	Increasing	2.4	2.6	2.0	2.0	Decreasing
Pieta	0.9	0.8	1	0.5	1.3	Increasing	0.0	0.0	1.3	1.1	Decreasing
Zurrieq	1.4	1.2	1.3	1.7	1	Decreasing	2.1	2.2	2.3	2.3	Decreasing
Msida	2.4	1.4	3.6	0.9	0.9	No Change	3.3	3.7	1.8	1.8	Increasing
Zejtun	5.1	4.5	5.9	2.7	0.9	Decreasing	3.6	3.4	3.3	3.0	Decreasing
Floriana	1.3	2.3	1.2	1.2	0.9	Decreasing	1.8	1.6	1.0	0.7	Decreasing
Rabat (Malta)	1.8	1.7	0.8	1.2	0.9	Decreasing	4.0	3.9	3.7	3.4	Decreasing
Swieqi	0.1	0.5	0	0	0.8	Increasing	0.0	0.0	0.0	1.8	Increasing
Xaghra	0.4	0.2	0.9	0.4	0.7	Increasing	1.3	1.1	0.9	1.0	Increasing
Balzan	0.1	0.3	0.7	1.3	0.7	Decreasing	0.9	1.1	1.4	0.9	Decreasing
Zebbug (Malta)	2.3	4	2.3	2	0.6	Decreasing	2.5	2.6	2.8	2.7	Decreasing
Kalkara	0.5	0.2	0.3	0.3	0.5	Increasing	0.7	0.6	0.6	0.7	Increasing
Luqa	1.4	1.2	0.5	1	0.5	Decreasing	1.7	1.7	1.6	1.6	Increasing
Santa Venera	0.9	0.7	0.7	1.4	0.5	Decreasing	1.6	2.0	2.3	1.6	Decreasing
Rabat (Victoria)	0.5	0.4	1.3	0.9	0.5	Decreasing	2.0	1.8	1.7	1.7	Decreasing
Siggiewi	1.2	0.5	0	0.8	0.4	Decreasing	1.6	1.6	1.7	1.9	Increasing
Xewkija	0.9	0.4	0.5	0.3	0.3	No Change	1.0	1.0	0.8	0.8	Increasing

Table 8.16: Percentage Offenders and Population by Locality sorted by 1950-1999 data and change 1980s-1990s: NUTS 5

Locality	Offender % 1950 to 1959	Offender % 1960 to 1969	Offender % 1970 to 1979	Offender % 1980 to 1989	Offender % 1990 to 1999	Offender % Change 1980s - 1990s	Population % Census 1957	Population % Census 1967	Population % Census 1985	Population % Census 1995	Population % Change 1980s - 1990s
Safi	0.1	0	0	0.1	0.3	Increasing	0.2	0.3	0.4	0.5	Increasing
Xghajra	0.1	0.2	0	0	0.3	Increasing	0.0	0.0	0.0	0.2	Increasing
Mqabba	0.3	1.4	1.3	2	0.3	Decreasing	0.7	0.7	0.7	0.7	Increasing
Ghaxaq	0.6	0.2	0.4	1.5	0.3	Decreasing	0.9	0.9	1.1	1.1	Increasing
Kirkop	0.4	0.4	0.2	0.6	0.3	Decreasing	0.4	0.4	0.5	0.5	Increasing
Iklin	0	0	0	0.4	0.3	Decreasing	0.0	0.0	0.0	0.8	Increasing
Dingli	0.1	0.2	0.1	0.1	0.2	Increasing	0.6	0.6	0.6	0.7	Increasing
Marsaxlokk	0.2	0	0.1	0.1	0.2	Increasing	0.5	0.5	0.7	0.8	Increasing
Zebbug (Ghawdex)	0.1	0.8	0.1	0.1	0.2	Increasing	0.4	0.4	0.3	0.4	Increasing
Attard	0.6	0.2	0.3	0.9	0.2	Decreasing	0.8	0.8	1.6	2.4	Increasing
Mellieha	0.1	0	0.3	0.6	0.2	Decreasing	1.3	1.4	1.3	1.6	Increasing
Nadur	0.4	0.4	0.4	0.5	0.2	Decreasing	1.3	1.2	1.0	1.0	Increasing
Qrendi	0.5	0.4	0.8	0.8	0.2	Decreasing	0.7	0.7	0.6	0.6	Decreasing
Ghajnsielem	0.3	0	0.3	0.1	0.1	No Change	0.6	0.6	0.5	0.6	Increasing
Mgarr	0.1	0.2	0.2	0.1	0.1	No Change	0.7	0.7	0.6	0.7	Increasing
Lija	0.4	0.4	0.2	0.1	0.1	No Change	0.7	0.7	0.9	0.7	Decreasing
Kercem	0.3	0.5	0	0	0.1	Increasing	0.4	0.4	0.4	0.4	Increasing
Qala	0.3	0.1	0.1	0	0.1	Increasing	0.5	0.5	0.4	0.4	Decreasing
Pembroke	0	1.7	0	1.5	0.1	Decreasing	0.0	0.0	0.0	0.6	Increasing
Gudja	0.3	0.1	0.1	0.4	0.1	Decreasing	0.5	0.6	0.6	0.8	Increasing
Gharghur	0.6	0.5	0.3	0.8	0.1	Decreasing	0.6	0.6	0.7	0.5	Decreasing
Gharb	0.1	0	0.3	0.4	0.1	Decreasing	0.4	0.4	0.3	0.3	Decreasing
Sannat	0.2	0	0.3	0.3	0.1	Decreasing	0.5	0.4	0.5	0.4	Decreasing
Mtarfa	0.1	0.2	0	0	0	No Change					No Data
Ghasri	0.3	0	0	0	0	No Change	0.1	0.1	0.1	0.1	Increasing
Munxar	0	0	0	0	0	No Change	0.0	0.1	0.1	0.2	Increasing
San Lawrenz	0.1	0.1	0	0	0	No Change	0.1	0.2	0.1	0.1	Decreasing
Mdina	0	0	0.1	0.4	0	Decreasing	0.3	0.3	0.1	0.1	Decreasing
Fontana	0.1	0	0.1	0.3	0	Decreasing	0.0	0.3	0.2	0.2	Decreasing
Ta' Xbiex	0	0	0.4	0.1	0	Decreasing	0.0	0.0	0.6	0.5	Decreasing

Note: changes marking as increasing or decreasing when figures are the same, such is due to the 2<sup>nd</sup> decimal change.



### Step 3: Grouping the Offender Residences

The third level of analysis is based on real offender address points that seek to analyse crime through a process that goes beyond legal or administrative boundaries such as NUTS and seeks an understanding of the actual offender addresses and their social and physical relationships.

This methodology is bolstered through the use of cluster methodology through K-Means clustering. The latter assessment of the 1990s offender analysis was based on clustering methodology at 6 clusters grouping. The result was rendered in ellipsoid format using the spatial statistical tool CrimeStat III and its NNH hotspot method. The K-means results are depicted in Table 8.17 and Figure 8.21, which show that offenders live in 6 main clusters with the most densely clustered being the Three Cities and one highly specific cluster based on just one other city: Valletta. The other districts as clustered are centered in the Western, North Harbours, Southern and Northern region in diminishing number of offenders within those clusters.

*Figure 8.21: Offender K-means clustering output sorted by 1990-1999 data*

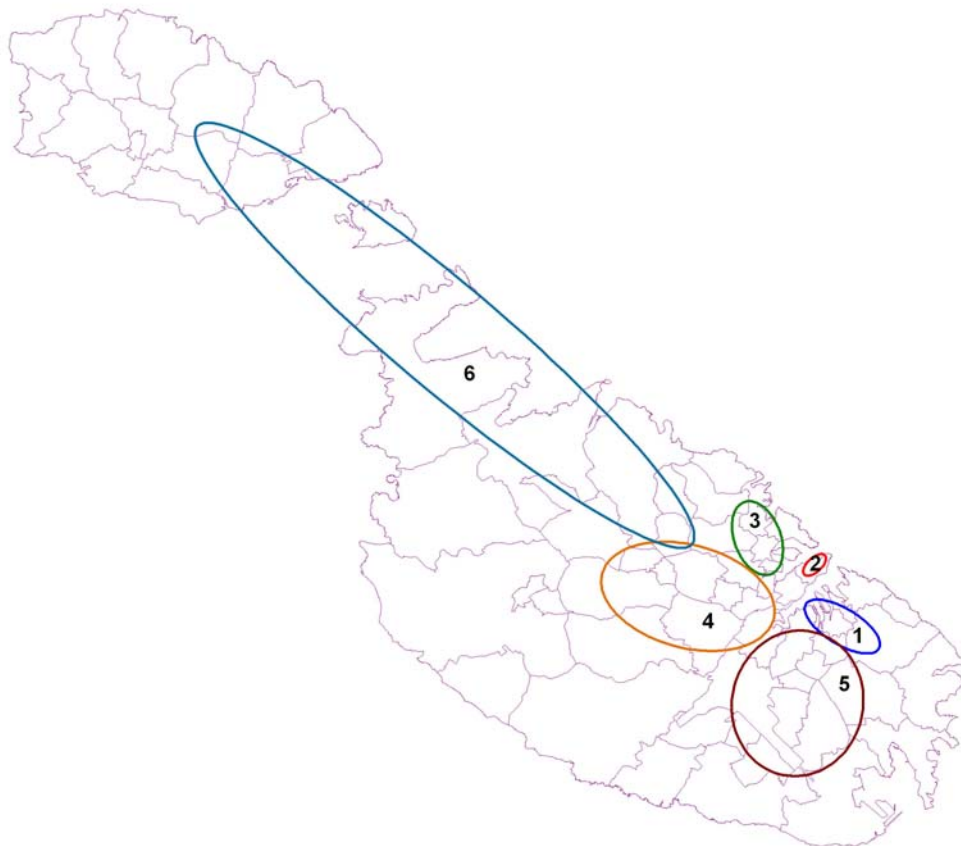


Table 8.17: Offender K-means clustering output sorted by 1990-1999 data

Cluster	Location	Rotation	X Axis	Y Axis	Area	Offenders
1	Three Cities	31.37	0.98	0.41	1.25	497
2	Valletta	47.60	0.16	0.32	0.16	254
3	North Harbours	69.63	0.88	0.53	1.46	285
4	Western	14.87	2.03	1.17	7.46	413
5	Southern	11.71	1.50	1.67	7.85	203
6	Northern	40.13	7.39	1.20	27.98	133

#### Step 4: Monitoring the Offenders' Residential Trends

The final logical step to establish the relationships between offender residence locations and their spatial structure is carried out through a change analysis of spatial clustering methodology using hotspot analysis. CrimeStat's III 'Hot Spot' Analysis I method was employed at 1 NNH (1 StDev) and at 2 NNH (2 StDev)<sup>159</sup>. Each decade's outputs (ellipsoidal hotspots) were overlaid over the next decade's output and the main change concentrations in offender location were identified. Such a method allows for the analysis of both hotspots and the inter-decade changes that may show how the residential concentration of offenders as a group changed over the decades and in turn elicits their residential preferences.

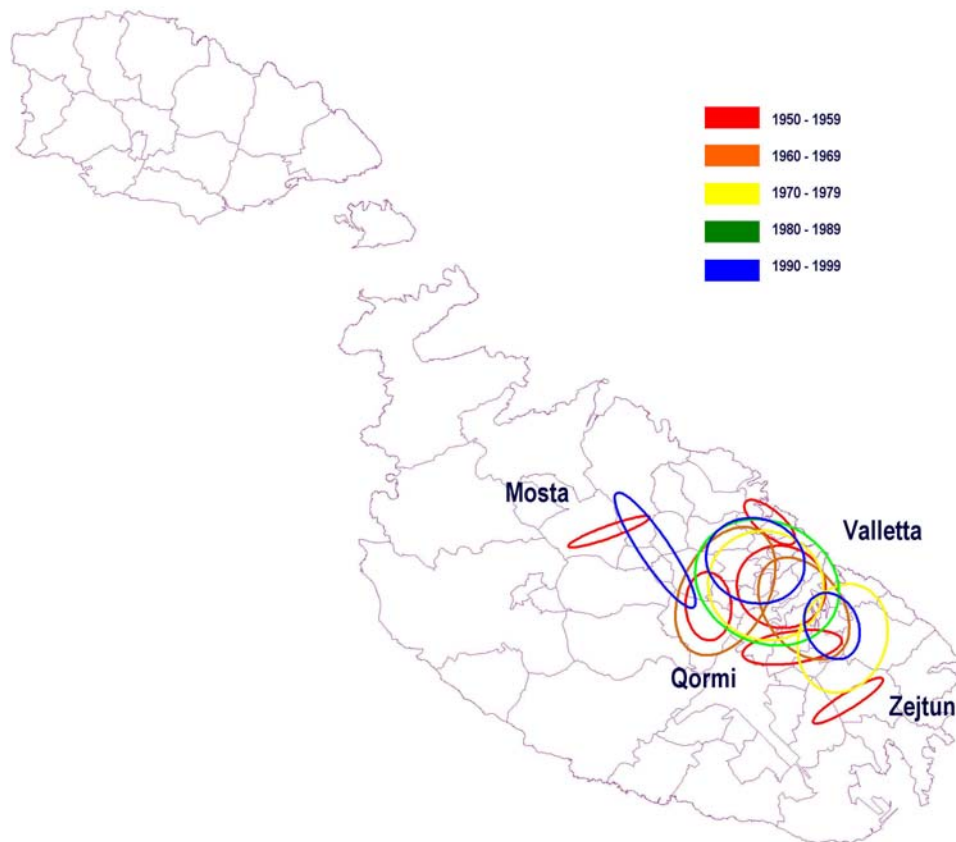
Figure 8.22 identifies the main 2NNH hotspots throughout the five decades under study, which once again shows a parallel result to the previous methodologies' results where all hotspots are centered within the conurbation and its suburbs. Each colour represents a decade: red the 1950s, orange the 1960s, yellow the 1970s, green the 1980s and blue the 1990s.

An overview of the inter-decadal changes shows that the 1950s had 6 hotspots situated around the harbour region and spreading towards the suburbs. In the inter-decade period there was a change in the 1950s to 1960s that concentrated offenders within 2 Standard Deviations (95% of all offenders), resulting in a compaction of the hotspots towards the northern and southern harbour regions (Figure 8.23a). This change was further emphasised during the next decade

<sup>159</sup> The NNH (hierarchical nearest neighbour) clustering is best described as "a constant-distance clustering routine that groups points together on the basis of spatial proximity. The user defines a threshold distance and the minimum number of points that are required for each cluster, and an output size for displaying the clusters with ellipses. The routine identifies first-order clusters, representing groups of points that are closer together than the threshold distance and in which there is at least the minimum number of points specified by the user. Clustering is hierarchical in that the first-order clusters are treated as separate points to be clustered into second-order clusters, and the second-order clusters are treated as separate points to be clustered into third-order clusters, and so on..... The NNH routine specifies the number of ellipse standard deviations to be calculated for each cluster: one standard deviation (1X - the default value), one and a half standard deviations (1.5X), or two standard deviations (2X). The default value is one standard deviation. Typically, one standard deviation will cover more than half the cases whereas two standard deviations will cover more than 99% of the cases, though the exact percentage will depend on the distribution." (Levine, 2002: Pg 2.28 - 2.30)

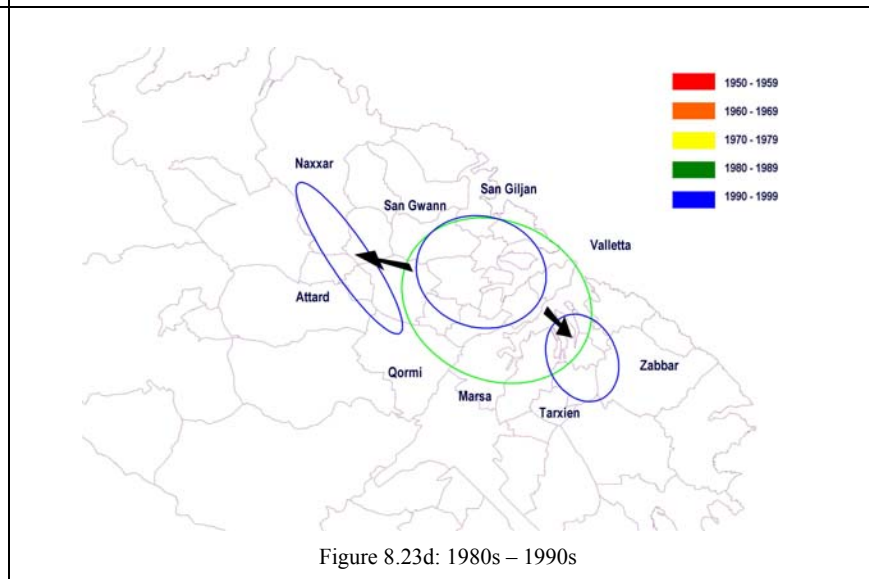
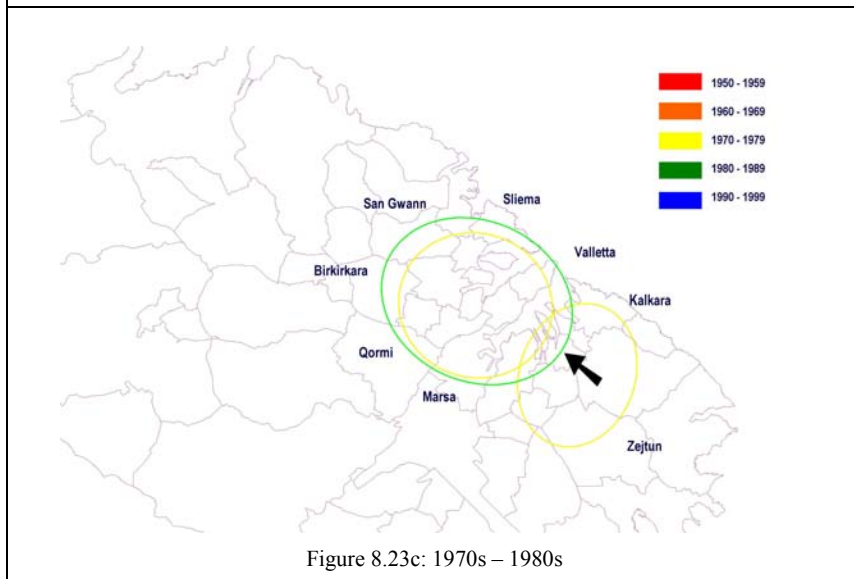
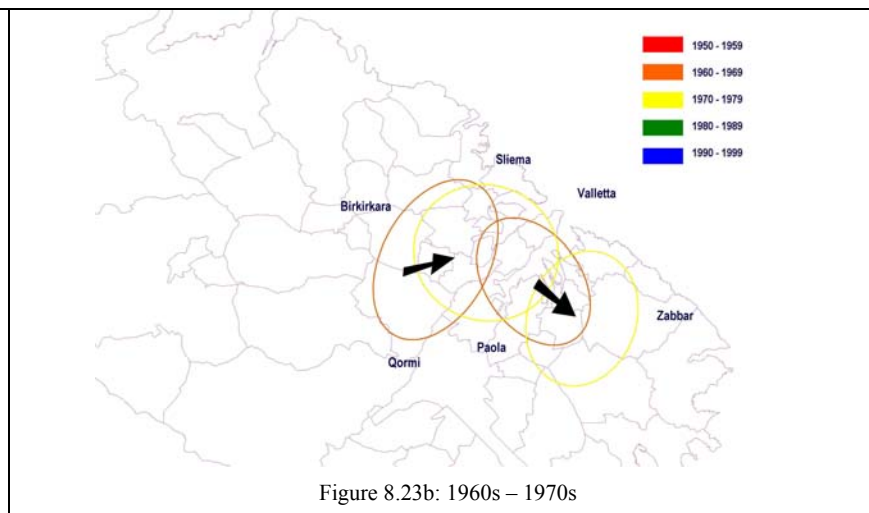
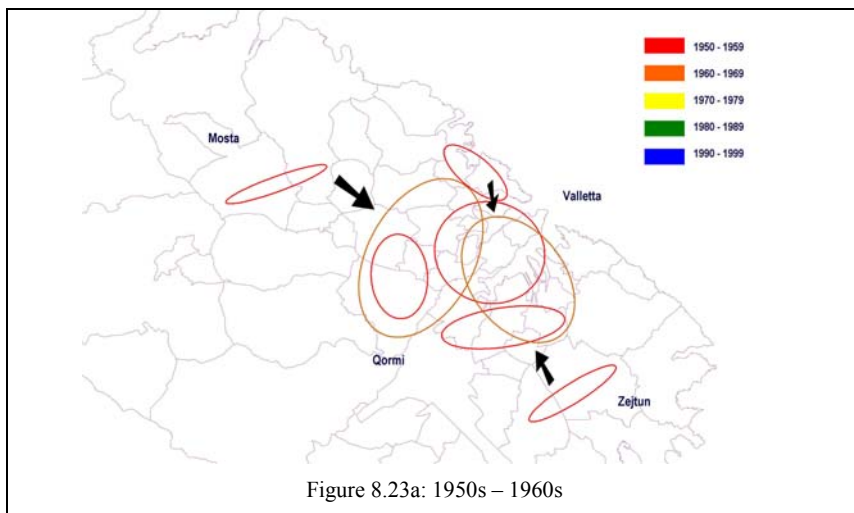
when the offenders' hotspots moved further into the two harbour regions (Figure 8.23b). Following this movement, the offenders further concentrated their spatial location towards the Valletta area, resulting for the first time in a single hotspot centered around the Xiberras (Valletta) peninsula (Figure 8.23c). Interestingly, a threshold seems to have been reached during the 1980s as the compaction slowed down and eventually inverted itself, so much so that the inter-decadal (1980-1990) change saw the creation of three clusters moving out from the centre, a new one centered exclusively on the Three Cities region and another new one further to the north-west (Figure 8.23d).

*Figure 8.22: A 2NNH map showing all the hotspots concentrated in the main conurbation between 1950 and 1999*



These changes could be explained in terms of availability of dwelling units in the different areas over the decades, which were slowly becoming very scarce till the late 1970s when free land through the HOS were released. This situation caused a general dispersion of population towards the suburbs and beyond, which also resulted in a depopulation of the old cores, where empty and abandoned dwellings started to appear, resulting in squatting and cheap rental, such as was the case of Valletta (Planning Authority Housing Topic Paper, 2002). The availability of free land and highly subsidised social dwellings in the 1980s led to another out migration of offenders to the outskirts which trend continued throughout the 1990s, particularly with the extension of development schemes and an ever increasing availability of vacant dwellings.

Figure 8.23a-d: 2NNH (Spatial Clustering) inter-decade change 1950s – 1990s

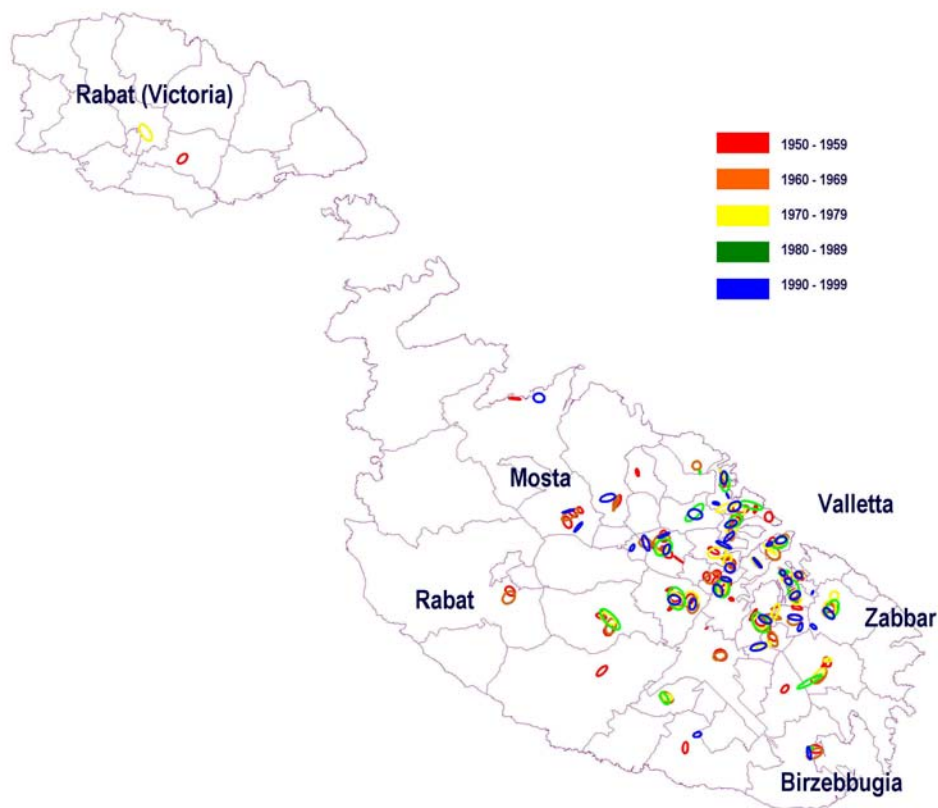


The high-level 2NNH analysis gave an overview of the main movements in offender residence, which is now tackled at a more detailed level at 1NNH.

The 1NNH analysis shows more distinct changes at local area level since at 1 standard deviation the ellipses depict which localities or sub-localities harbour offender hotspots. In addition, a change analysis exercise at 1NNH level allows for a better understanding of offenders' movements over the decades.

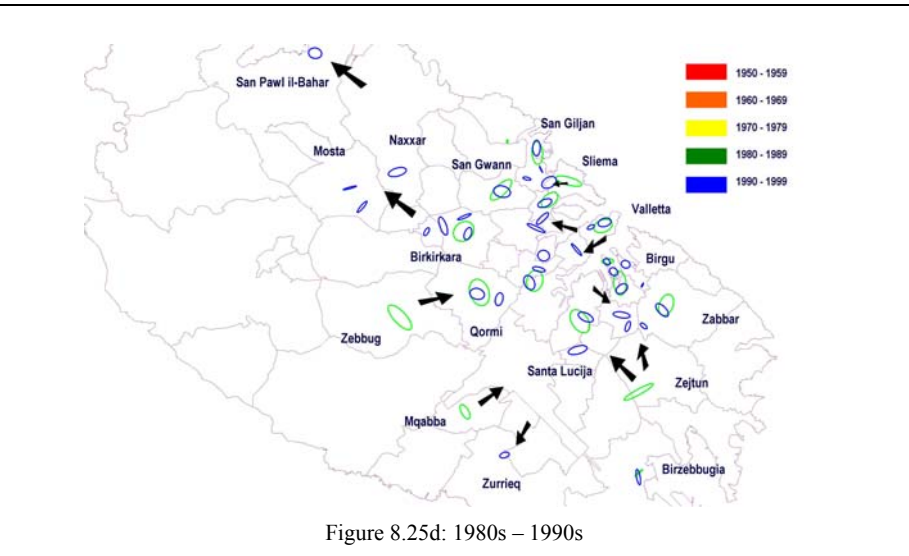
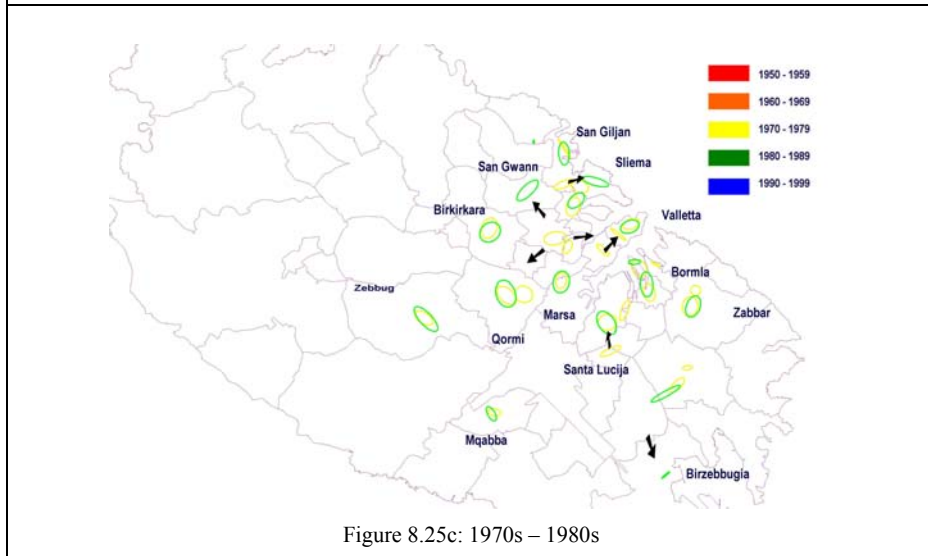
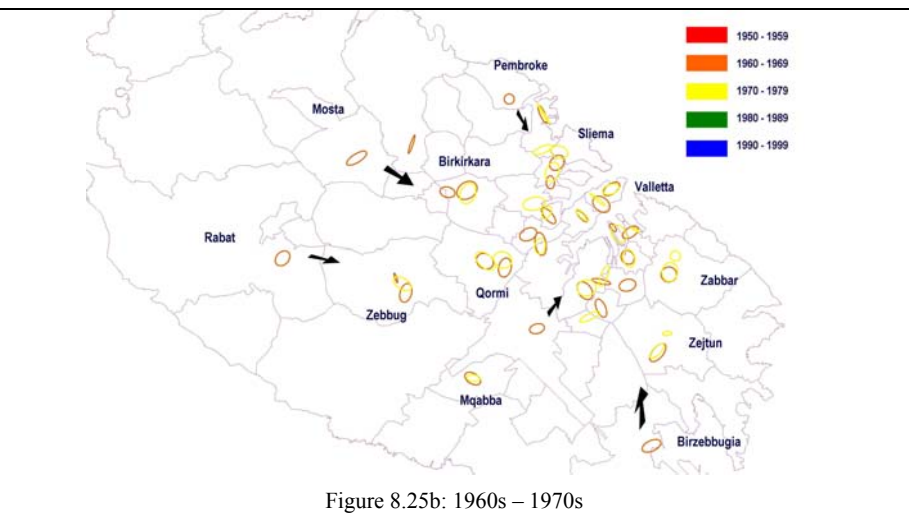
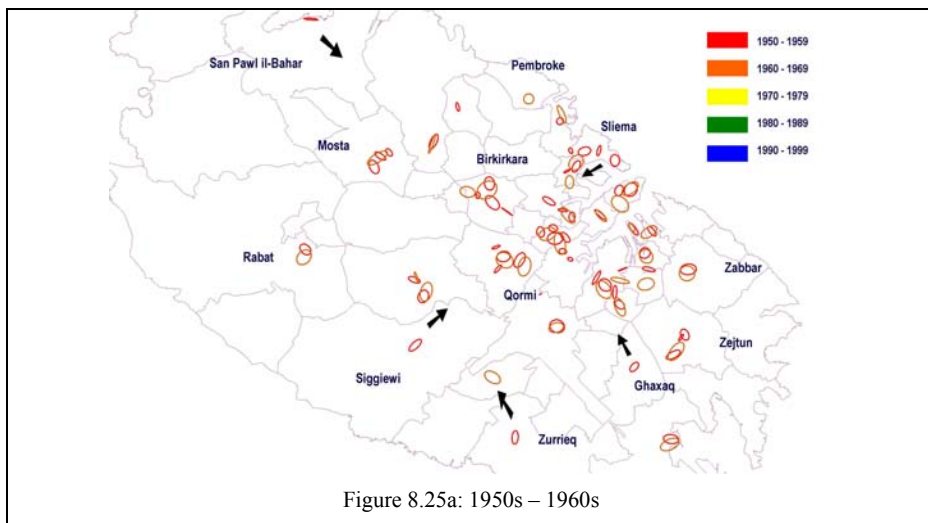
Figure 8.24 highlights all the five decades' hotspots based on the same colour scheme used in the 2NNH exercise. The main concentration can still be found around the conurbation and its suburbs, however new hotspots are found in peripheral towns/villages and in the island of Gozo.

*Figure 8.24: A 1NNH map showing all the hotspots between 1950 and 1999*



The 1NNH analysis shows that the inter-decadal changes generally follow the 2NNH trends but also identify areas within the main 2 standard deviation ellipses that have gained or lost offenders.

Figure 8.25a-d: INNH (Spatial Clustering) inter-decade change 1950s – 1990s





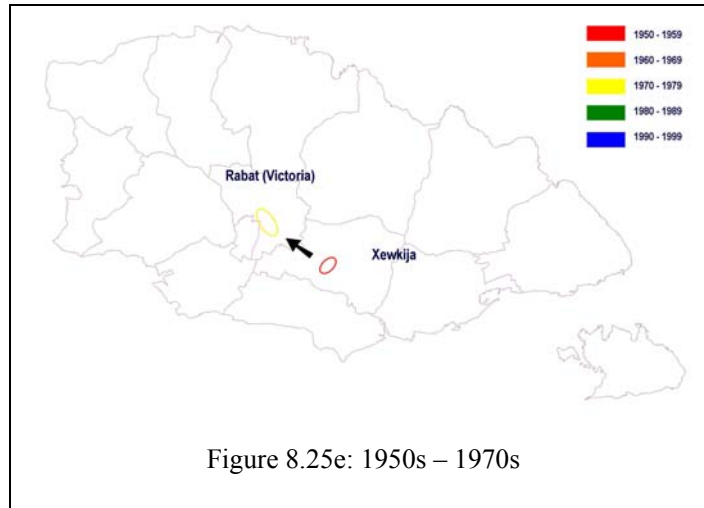


Figure 8.25e: 1950s – 1970s

The main changes during the 1950s to 1960s highlight how the compaction of the hotspots towards the northern and southern harbour regions was widespread with migration from the peripheries from such towns as San Pawl il-Bahar, Siggiewi and Zurrieq (Figure 8.25a). Sliema, though situated close to the harbour lost its hotspot during this decade. The next inter-decadal phase movement (1960s to 1970s) saw a further compaction with further movement towards the harbour region with such towns as Birzebbugia, Rabat and Mosta losing their offender hotspots (Figure 8.25b).

The 1970-1980s change again saw movements towards Valletta but generally there were movements within the conurbation with only one movement towards the south to Birzebbugia and another back into Sliema (Figure 8.25c). As in the case of the 2NNH analysis, the 1980s to 1990s movement saw out-migration from the centre towards the peripheries to towns such as Mosta, Naxxar, San Pawl il-Bahar and Zurrieq (Figure 8.25d). Once again Sliema lost its hotspot at this stage. The island of Gozo saw only one change over two decades with a hotspot in Xewkija during the 1950s gradually moving to Rabat (Victoria) during the 1970s (Figure 8.25e).

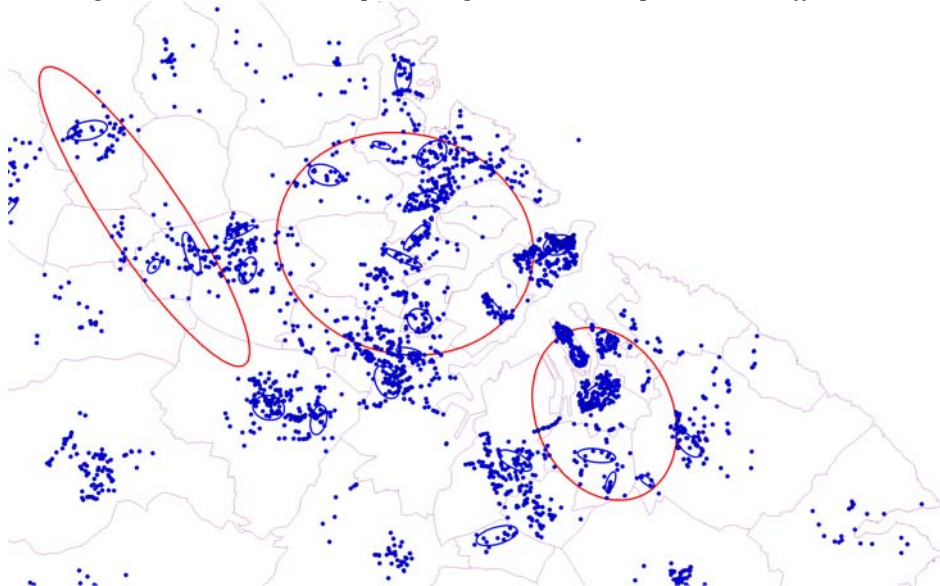
Interestingly, most of the towns and cities in the Northern and Southern Harbour regions kept their hotspots highly intact, particularly the Three Cities and Valletta.

Figures 8.26a-d show detailed 1990s maps of the offender residence locations through 2NNH and 1NNH hotspots and how the latter fit within the 2NNH. The sample maps detail the offender residence locations as well as the 1 and 2 standard deviation hotspots where they are mostly concentrated. Figure 8.26a depicts the conurbation councils and the 3 main 2NNH hotspots, whilst Figures 8.26b-d show the two hotspot levels for the Three Cities, Pieta (Northern Harbour region) and Valletta respectively. These maps show how the different 1NNH hotspots fit within the larger 2NNH areas. Note that all councils' maps were generated as part of the study, and

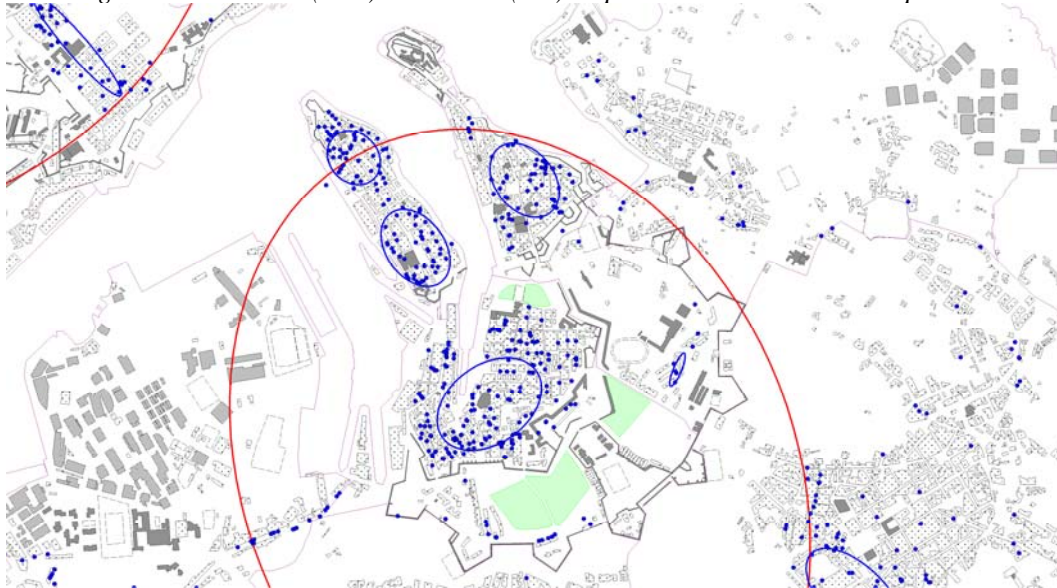
Appendix 8 depicts the maps of those local councils' that have overlaying offender and poverty hotspots.

Interestingly, Figure 8.26b shows that Isla harbours 2 main hotspots with a large one in Bormla and 2 in Birgu, one concentrated in the south-eastern areas and another main one the fortified part of the city, highlighting how the main offender-areas can be analysed in detail using this methodology.

*Figure 8.26a: A 2NNH map showing the 1990s hotspots and the offender location*

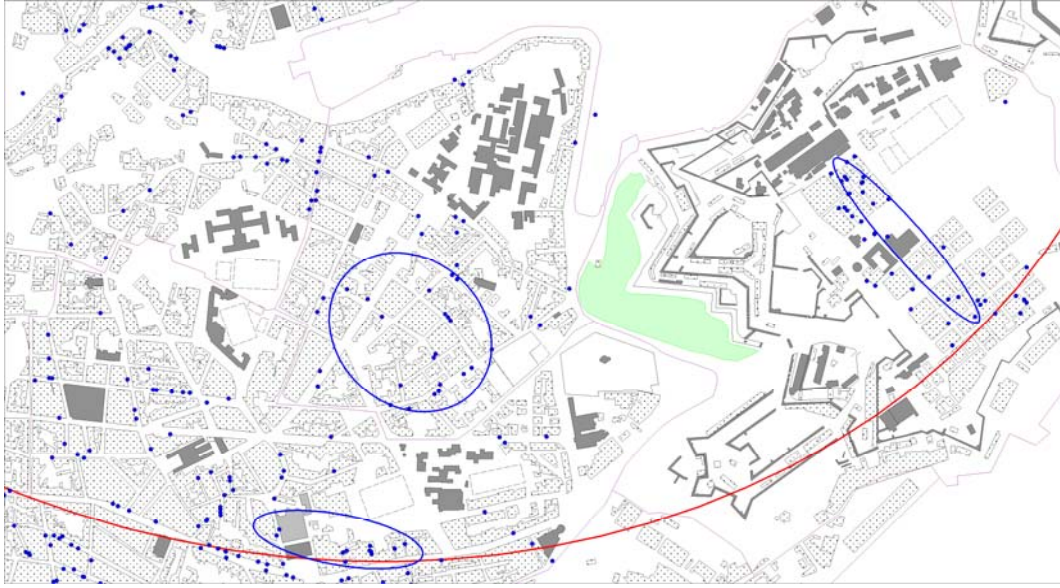


*Figure 8.26b: 1NNH (blue) and 2NNH (red) map: Three Cities 1990s' hotspots*





*Figure 8.26c: 1NNH (blue) and 2NNH (red) map: Pieta 1990s' hotspots*



*Figure 8.26d: 1NNH (blue) and 2NNH (red) map: Valletta 1990s' hotspots*



This section indicated that rather than experiencing a North/South divide, offender residence regionalisation is centered around a harbour and non-harbour structure. A NUTS 5 analysis shows a long-term offender residential preference for the old harbour towns and cities until the last decade. Further detailed spatial statistical analysis helped to trace the offender residential movements over the decades from an initial harbour concentration to an eventual spreading out into the outer villages and towns.

## Summary of the Offenders' Residential Preferences

In summary, the offender lives in the conurbation, with increasing migration to the peripheries during the 1990s, originates mainly from the cities of Bormla and Valletta, lives in highly clustered areas close to other offenders. They live in high population density areas in the old cities and lives in areas characterised by poverty. Offenders tend to prefer less the UCA as against the HOS. The councils hosting the highest concentration of offenders are also experiencing a loss in population.

### 8.2 What are the social parameters that affect offenders?

Following a review of the relationships between offenders and their environment, the next step entails the understanding of poverty in Malta, which would lay the ground for further analysis in the relationship between offender residence and poverty.

This review takes a wider look at which parameters distinguish specific areas in having higher or lower rates of poverty. The analysis is based on residential zones and their different components, which study tries to identify whether the areas that offenders live in and that had earlier been identified as having high rates of offenders, are significantly different from other low-offender-rate areas.

This section investigates the level of relationships that can be found between poverty and categories of residential units. The data is calculated using welfare data hotspots that indicate poverty based on the unemployment data (in this case unemployment benefit). The hotspot layers resulting from the INNH were analysed using SQL spatial querying against different residential-related data layers.

*Research Question: Is poverty related to dwelling type?*

A poverty against dwelling unit analysis shows that relatively 'poorer' persons live mainly in terraced units with over 51.5% spatial intersections of poverty hotspots as layered over dwelling category. This figure is higher than that of 41.2% for apartments. The relatively high terraced dwelling figure indicates that 'poor persons' may have access to large dwellings though they do not necessarily claim ownership, either due to renting, subsidised renting as well as squatting.

In view of this, a direct relationship between poverty and residence type could not be established and in turn the research question is not readily answered.

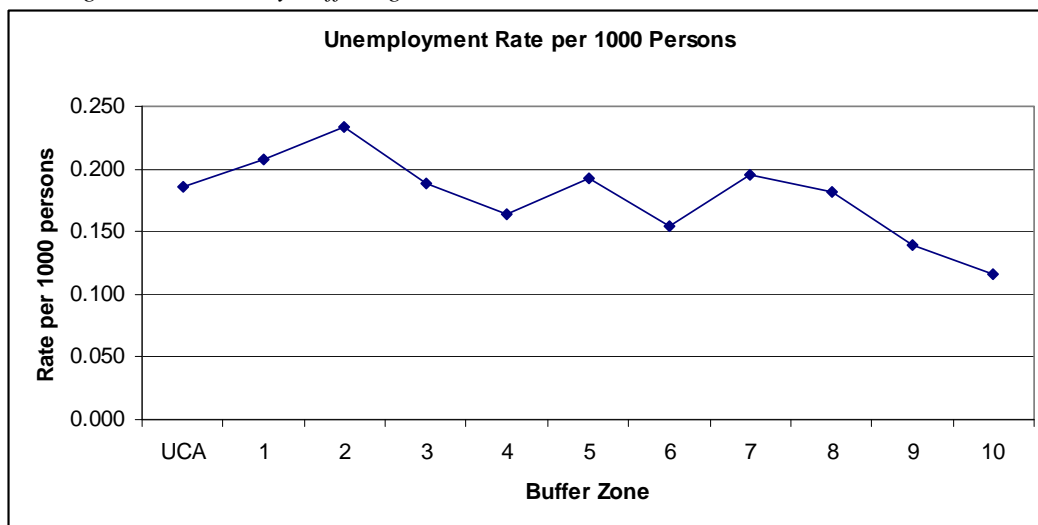
- **Poverty and the Cores**

Interestingly, the next analysis shows a very high relationship between poverty and UCA\_Village Cores which areas contain nearly 62% of all poor persons. The rest of the poverty component are analysed using buffering methodology to facilitate a better understanding of poverty, which analysis shows that poverty decreases steadily with every 100 meters movement outwards from the village core, from 49% contained within the first buffer to 2.9 % one kilometre out from the UCA boundary.

Research Question: Do poor areas tend to be located nearer to the old (village cores) areas?

A buffer analysis based on the UCA\_VC was carried out at the standard set of 100m buffers radiating out from the UCA boundaries up to 1000m. The analysis of poverty was based on an unemployment per 1000 persons in the buffer areas as based on a street centroid point data within the 100m buffers<sup>160</sup>.

Figure 8.27: Poverty Buffering

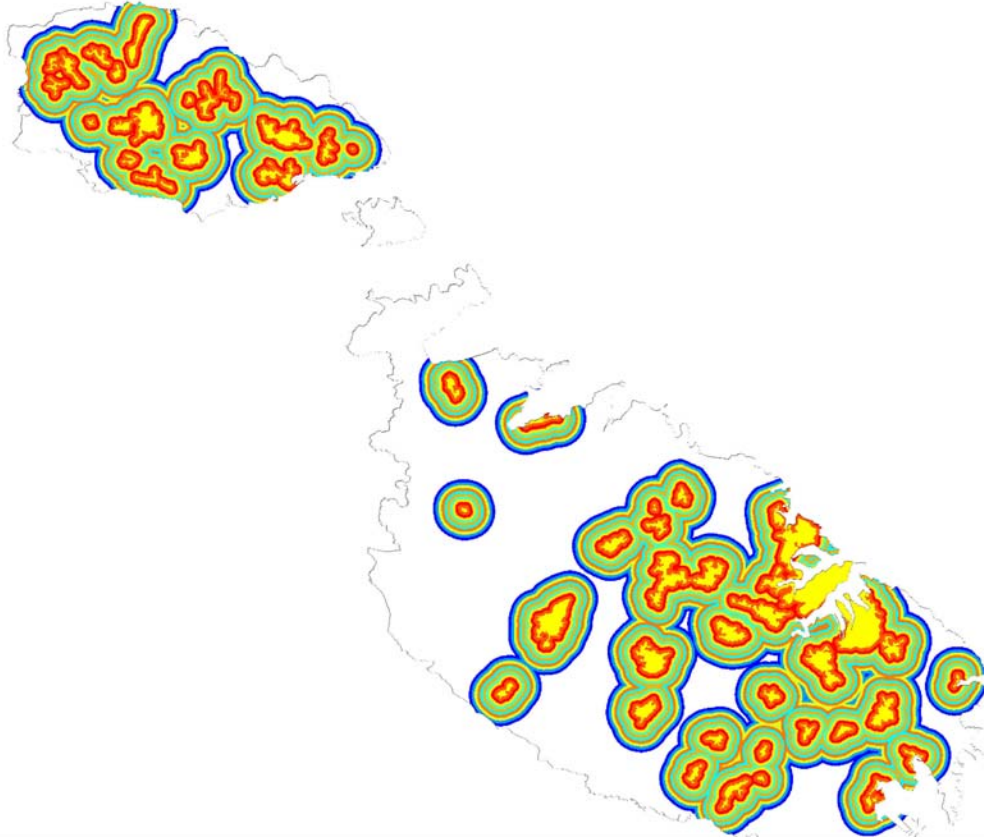


Results show that the immediate buffer zones out from the boundary experience an increase in poverty rate which alternatively declines and increases though generally declining over distance from 0.207 per 1000 persons at 100m to 0.116 at 1000m (Figure 8.27). Figures 8.28a-b depict the poverty buffers results using region-to-grid interpolation in top and perspective views, through a colour scheme representing high rates as red declining to yellow and eventually blue

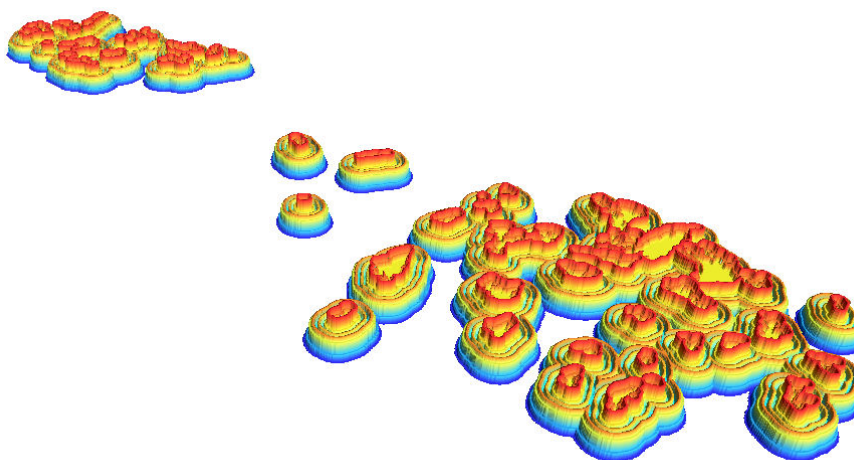
<sup>160</sup> Unemployment data was given at street level, with a spatial entity registered through a street centerline centroid.

for low rates. Whilst the top view shows a clear distinction from low to high to low movements, the perspective views facilitates viewing the movement in peaks and troughs, with high concentrations in the old cities and village cores (yellow areas).

*Figure 8.28a: Poverty Buffering Grid File – Top View*



*Figure 8.28b: Poverty Buffering Grid File – Perspective View*



- **Poverty and Dwelling Density**

Dwellings density is a major issue in the Maltese Islands with an ever growing stock that is also changing in character leading to small and denser units clustered together.

Research Question: How far is poverty higher in high dwelling density areas?

An analysis to show whether there is a relationship between poverty and dwelling density resulted in the hypothesis being refuted as the statistical analysis did not elicit any relationship where Spearman's rho of 0.079 and a significance of 0.023, shows that the figure is higher than a 0.001 probability (Table 8.18).

*Table 8.18: Crosstabulations and Spearman Correlation Tests for Poverty risk and Dwelling density*

**Poverty\_Risk\_Recode \* Dwelling\_Density Crosstabulation**

			Dwelling_Density				Total
			Less than 100	101 to 500	501 to 1000	1000 plus	
Poverty_Risk_Recode	Less than 100	Count	93	169	94	74	430
		% within Dwelling_Density	53.4%	56.3%	53.4%	41.8%	52.0%
	101 to 500	Count	81	131	82	103	397
		% within Dwelling_Density	46.6%	43.7%	46.6%	58.2%	48.0%
Total		Count	174	300	176	177	827
		% within Dwelling_Density	100.0%	100.0%	100.0%	100.0%	100.0%

**Symmetric Measures**

		Value	Asymp. Std. Error <sup>a</sup>	Approx. T <sup>b</sup>	Approx. Sig.
Interval by Interval	Pearson's R	.084	.035	2.408	.016 <sup>c</sup>
Ordinal by Ordinal	Spearman Correlation	.079	.035	2.274	.023 <sup>c</sup>
N of Valid Cases		827			

a. Not assuming the null hypothesis.

b. Using the asymptotic standard error assuming the null hypothesis.

c. Based on normal approximation.

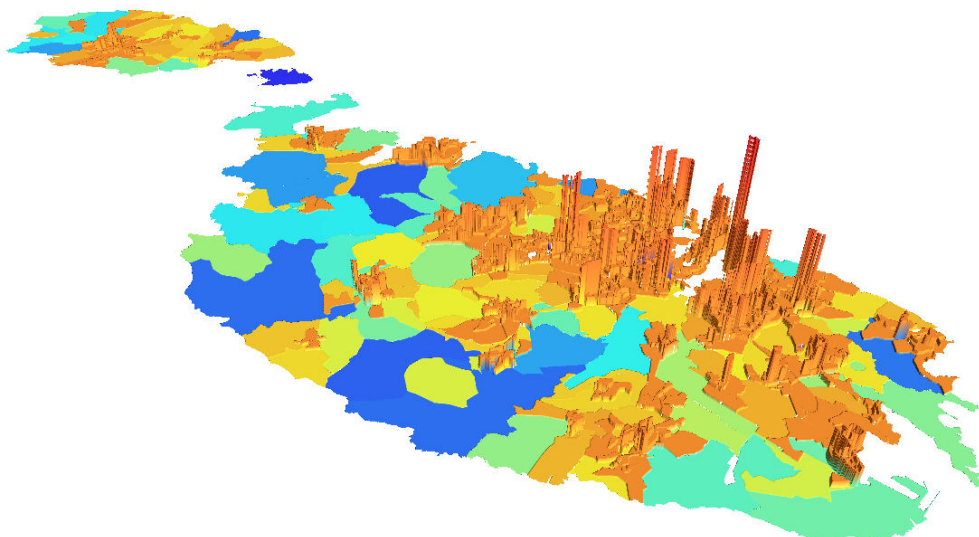
As per direction of clustering strength, Moran's I spatial statistics results indicate that whilst both variables show evidence of clustering (Moran's I of 0.028094 for poverty is higher than that for dwellings densities at 0.010079), there is a higher concentration of poverty rate than would be expected based on dwelling density (Table 8.19).

Table 8.19: Moran's I spatial statistics tests for Poverty risk and Dwelling density

Poverty risk Moran's I	Dwelling density Moran's I
Spatial Autocorrelation for Point Data:	
Sample size .....: 843	Sample size .....: 843
Measurement type .....: Direct	Measurement type .....: Direct
Start time.....: 11:56:22 AM, 07/20/2006	Start time.....: 12:12:22 PM, 07/20/2006
Moran's "I" .....: 0.028094	Moran's "I" .....: 0.010079
Spatially random (expected) "I" ....: -0.001188	Spatially random (expected) "I" ....: -0.001188
Standard deviation of "I" .....: 0.001468	Standard deviation of "I" .....: 0.001468
Normality significance (Z) .....: 19.948440	Normality significance (Z) .....: 7.675656
p-value (one tail) .....: 0.0001	p-value (one tail) .....: 0.0001
p-value (two tail) .....: 0.0001	p-value (two tail) .....: 0.0001
Randomization significance (Z) .....: 19.950019	Randomization significance (Z) .....: 7.679327
p-value (one tail) .....: 0.0001	p-value (one tail) .....: 0.0001
p-value (two tail) .....: 0.0001	p-value (two tail) .....: 0.0001
End time.....: 11:56:23 AM, 07/20/2006	End time.....: 12:12:23 PM, 07/20/2006

A spatial analysis of dwelling density shows a dispersed 3D map with a wider area within the conurbation as well as outside the suburbs. Figure 8.29 shows a large number of peaks representing dwelling density. This situation has more to do with lack of space than poverty. Most of the areas are being developed as apartments, which situation results in higher densities. Apartment pricing is not cheap and very few areas, such as the Three Cities, have high dwelling densities and high poverty. Some of the highest densities are in Sliema with the most expensive apartments available on the local market.

Figure 8.29: INNHotspot analysis for offender residence and poverty



- **Poverty and the Housing Estates**

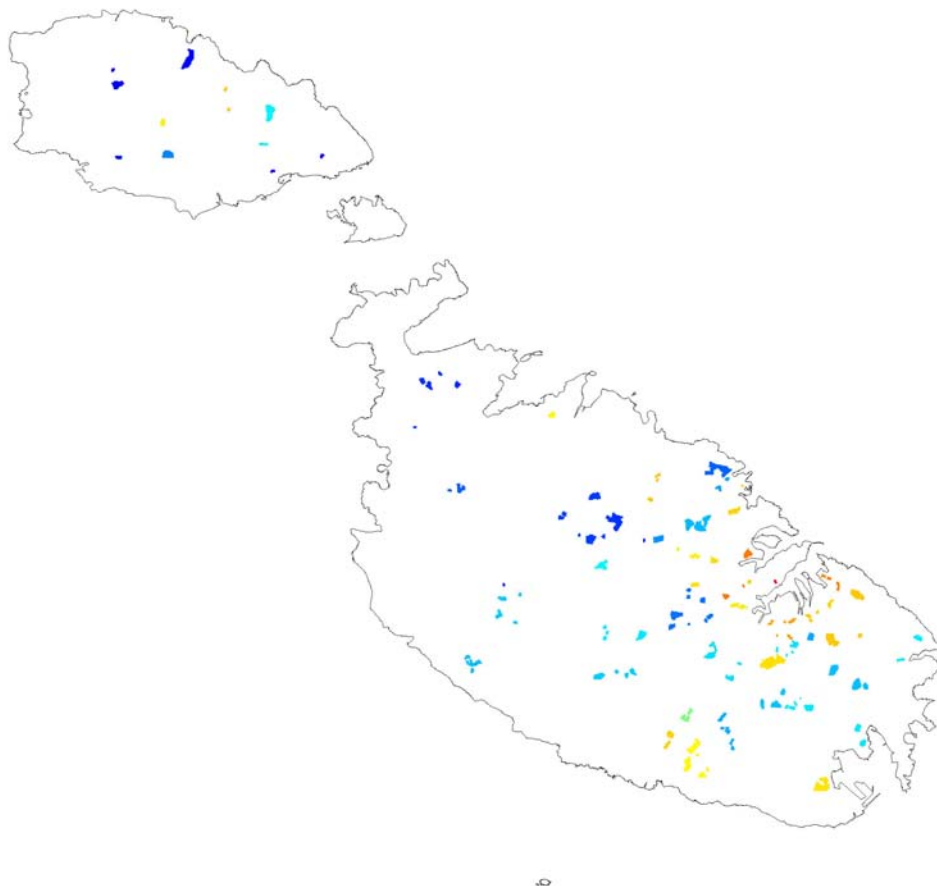
A final analysis of poverty areas and residential aggregation centres on the HOS and reviews whether they are centres of poverty.

Research Question: Do Housing Estates have higher rates of poverty than elsewhere?

Analysing whether HOS host poorer persons at different rates than other areas that did not have HOS within them, results in the fact that 37.3% of all poverty hotspots have some kind of spatial intersection with the HOS boundaries. In addition HOS host 46.9% of all persons who registered as falling above the national standard poverty rate, indicating a large percentage of poorer residents.

A spatial analysis using MapInfo and Vertical Mapper show that there is an aggregation of poorer HOS around the Grand Harbour depicted by the yellow to orange range (Figure 8.30). This shows that even within the HOSs there are easily discernable poorer estates than other estates in the periphery.

*Figure 8.30: HOS -poverty relationship*





## Summary of the Poverty parameter

In summary, as a preparation for the offender and poverty analysis, this section's results show that there is no easily discernable relationship between dwelling type and poverty. They also show that poor people live close to the village core but not essentially within, as well as there being no relationship between dwelling density and poverty, and finally HOS host nearly half of all poor areas, with particular concentration of the latter close to or within the harbour region.

### 8.2.1 Offenders and Poverty

Once the offender residence and poverty groundwork has been laid, the next phase attempts to look at the relationships between offender location and a number of social parameters. Each parameter is analysed in relation to the selected others using both tabular statistical tools such as SPSS and spatial statistical tools as CrimeStat III. This section relies heavily on and extends Craglia *et al's* (2000) risk assessment methodology that essentially creates rates of offences for small areas as compared to national rates. This methodology was used to define those areas that have a lower or higher than the national standard rates and the resultant rate is compared to the other variable's rate in order to identify any relationship.

The workings employed through this method were created through a stepped process aimed at identifying any relationships between offender densities, population density and poverty rates. The rates as calculated were based on the entire Maltese Islands' Enumeration Areas (EAs – totaling 843).

The Craglia methodology initially elicits the national rate (for example, employment) against which to compare the small-area results. It then establishes the expected number of persons pertaining to that category within specific small areas such as the EAs and then rates the result against the observed figure, in turn calculating the potential rate for that particular parameter.

As an example, the rate formula for poverty is listed in Figure 8.31 for guidance. A full list of calculations is listed in Appendix 9.



Figure 8.31: Formula for the calculation of Risk of Poverty based on Population

Step 1: Calculating the Standard Poverty Rate

$$\begin{aligned} \text{Standard Poverty Rate (SPR)} &= \frac{\text{Total Unemployed}}{\text{Total Persons}} \\ \text{Standard Poverty Rate (SPR)} &= \frac{7,326}{367,879} \\ \text{SPR} &= 0.02 \end{aligned}$$

Step 2: Calculating the Expected Poverty in Enumeration Areas

$$\begin{aligned} \text{Expected Poverty in Enumeration} \\ \text{Areas (EP) for each EAs} &= \text{SPR} \times \text{No. of Persons in each} \\ &\quad \text{EAs} \end{aligned}$$

Step 3: Calculating the Risk of Poverty for each Enumeration Area

$$\begin{aligned} \text{Risk of Poverty for each EAs} &= \frac{\text{Observed Unemployment} \\ \text{(OP)}}{\text{Expected Poverty (EP)}} \times 100 \end{aligned}$$

Source: Based on Craglia *et al* (2000)

Note that the resultant categories are regrouped further into 4 categories for better understanding of the analysis result. These were grouped as follows: those below or at the national standard rate (100), with the subsequent categories grouped between 100 – 500 (upto 5 times national rate), 500 – 1000 (upto 10 times national rate), and 1000 plus (higher than 10 times national rate). These regrouped categories represent the figures compared between the different variables, eliciting if there is a significant relationship between the different categories. Note that the 5-times and 10-times grouped categories were chosen since it was deemed too complex to review each multiple of the national rate for each of the 843 Enumeration Areas (EAs) as well as such a large number of groupings would render any mapped outputs unreadable in understanding polygon shading. Thus the 200, 300, 400, 600, 700, 800 and 900 were not utilised for the results.

- **Offender Density and Population Density**

The first analysis carried out was based on the need to review if population density is related to offender density.

*Research Question: Do some locations have a high offender density than one would expect on the basis of their population density?*

Using a Spearman’s correlation test, the study shows that there is a modest significant relationship (Cohen and Holliday, 1982) between population density and offender density at a rho of 0.394 at a significance of  $p = 0.000$  (Table 8.20). The relationship is a positive one indicating that the higher the population density, the higher is the probability of increasing offender density (52.9%).

*Table 8.20: Crosstabulations and Spearman Correlation Tests for population density and offender density*

**Risk\_Population Density\_Recode \* Risk\_Offender\_Recode Crosstabulation**

			Risk_Offender_Recode				Total
			Less than 100	101 to 500	501 to 1000	1000 plus	
Risk_Population Density_Recode	Less than 100	Count	146	8	0	0	154
		% within Risk_Offender_Recode	30.9%	5.9%	.0%	.0%	18.3%
	101 to 500	Count	127	67	19	20	233
		% within Risk_Offender_Recode	26.8%	49.3%	25.7%	12.7%	27.7%
	501 to 1000	Count	117	53	26	54	250
		% within Risk_Offender_Recode	24.7%	39.0%	35.1%	34.4%	29.8%
	1000 plus	Count	83	8	29	83	203
		% within Risk_Offender_Recode	17.5%	5.9%	39.2%	52.9%	24.2%
Total	Count	473	136	74	157	840	
	% within Risk_Offender_Recode	100.0%	100.0%	100.0%	100.0%	100.0%	

**Symmetric Measures**

		Value	Asymp. Std. Error <sup>a</sup>	Approx. T <sup>b</sup>	Approx. Sig.
Interval by Interval	Pearson's R	.424	.027	13.535	.000 <sup>c</sup>
Ordinal by Ordinal	Spearman Correlation	.394	.030	12.394	.000 <sup>c</sup>
N of Valid Cases		840			

a. Not assuming the null hypothesis.

b. Using the asymptotic standard error assuming the null hypothesis.

c. Based on normal approximation.

Translating the statistics into Table 8.21 shows that the lower the population density living in an area the lower the offender density is. At the other extreme end of the matrix a very high

population density rate (at 1 factor above the national level) there is a corresponding very high offender density. A description of Table 8.21 shows that the shaded cells indicate the highest percentage of Enumeration Areas (EAs) that have the corresponding density type; as an example at the top left cell 30.9% of EAs that have a population density less than the national (100) also have an offender rate less than national. At the other end of the matrix (bottom right) 52.9% of EAs that have registered more than ten times (10x100 = 1000 plus) the national rate, also register more than ten times the offender rate.

*Figure 8.32: Map of Population and Offender Densities Rate Assessment*

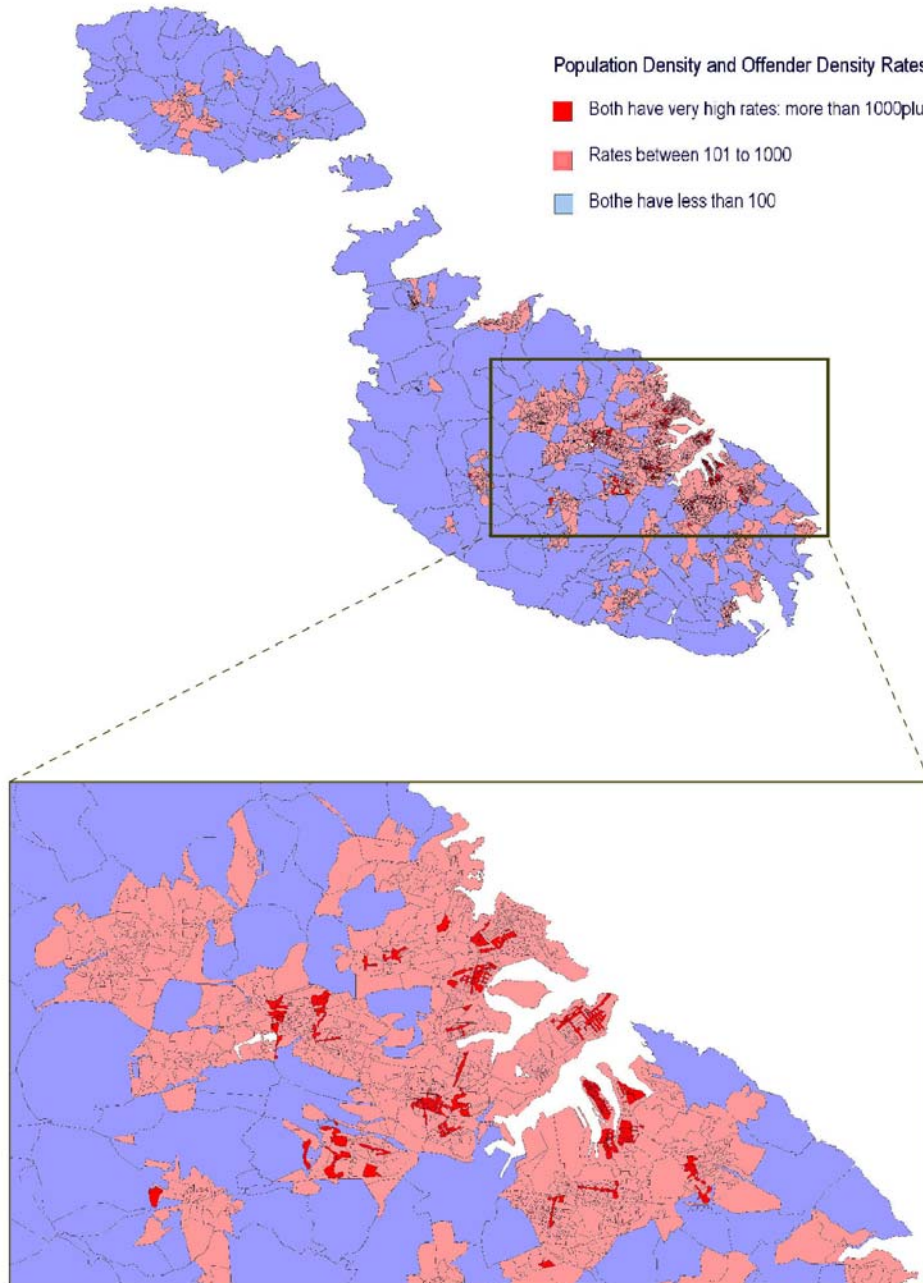


Table 8.21: Crosstabs Rate assessment of Population and Offender Densities

Population Density	Rate of Offenders residing in Area			
	Less than 100	101 to 500	501 to 1000	1000 plus
Less than 100	30.90%	5.90%	0.00%	0.00%
101 to 500	26.80%	49.30%	25.70%	12.70%
501 to 1000	24.70%	39.00%	35.10%	34.40%
1000 plus	17.50%	5.90%	39.20%	52.90%

The results were translated into spatial format that sought to identify which EAs fall within each of the categories. Figure 8.32 depicts the rate maps: blue indicates a rate of less than 100, with pink depicts increasing rates up to more than 1000. The detailed map takes a closer look at which EAs have a very high (1000plus - red) rates essentially highlighting those areas that have both very high population and offender densities, mainly the Three Cities and Valletta as well as such areas as Gzira, Qormi and Marsa.

Through the use of spatial statistics based on Moran's I Spatial Autocorrelation for Point Data of 0.009482 for offenders is less than that for population at 0.028428 (Table 8.22), the results show that there is a clustering of offenders and population though in effect there is a slightly less concentration of offenders than would be expected based on population.

Table 8.22: Moran's I spatial statistics tests for offender rate and population density

Offender rate Moran's I	Population density Moran's I
Spatial Autocorrelation for Point Data:	
Sample size .....: 843	Sample size .....: 843
Measurement type .....: Direct	Measurement type .....: Direct
Start time.....: 11:50:13 AM, 07/20/2006	Start time.....: 11:40:41 AM, 07/20/2006
Moran's "I" .....: 0.009482	Moran's "I" .....: 0.028428
Spatially random (expected) "I" ....: -0.001188	Spatially random (expected) "I" ....: -0.001188
Standard deviation of "I" .....: 0.001468	Standard deviation of "I" .....: 0.001468
Normality significance (Z) .....: 7.268992	Normality significance (Z) .....: 20.175965
p-value (one tail) .....: 0.0001	p-value (one tail) .....: 0.0001
p-value (two tail) .....: 0.0001	p-value (two tail) .....: 0.0001
Randomization significance (Z) .....: 7.271064	Randomization significance (Z) .....: 20.176473
p-value (one tail) .....: 0.0001	p-value (one tail) .....: 0.0001
p-value (two tail) .....: 0.0001	p-value (two tail) .....: 0.0001
End time.....: 11:50:14 AM, 07/20/2006	End time.....: 11:40:42 AM, 07/20/2006

### Analysing the variables at a different Spatial Level: Local Council

Note must be also made that the majority offenders live in high population density areas, which is made more interesting when reviewed against a council-based analysis based on Table 8.16 with the population densities calculated for each local council. Table 8.23a&b shows that those areas that experienced a decreasing population density also experienced a decreasing offender density and vice versa (33 in total), except for 19 localities that experienced decreasing offender change as against increasing population change. Whilst this is a positive occurrence, the most concerning issues that is highlighted again refers to the 7 localities that have experienced an

increase in offender change in the face of decreasing population change. These councils as identified in Table 8.16 comprise Bormla, Valletta, Qormi, Gzira, San Giljan, Paola and the small town of Pieta. Between them these localities host 45.8% of all offenders. This is definitely a case where the relationship between population density and offender change needs to be reviewed further in future to elicit significance at the different spatial levels.

*Table 8.23a: Population and Offender Densities Change Analysis: 1980s-1990s*

Population Density Change 1980s - 1990s	Offender % Change 1980s - 1990s			Grand Total
	Decreasing	Increasing	No Change	
<b>Decreasing</b>	13	7	1	21
<b>Increasing</b>	19	20	7	46
<b>No Data</b>			1	1
<b>Grand Total</b>	32	27	9	68

*Table 8.23b: Decreasing Population and Increasing Offender Densities Change Analysis: 1980s-1990s*

Locality	Offender % Change 1980s - 1990s	Population Density Change 1980s - 1990s
Bormla	Increasing	Decreasing
Valletta	Increasing	Decreasing
Qormi	Increasing	Decreasing
Gzira	Increasing	Decreasing
San Giljan	Increasing	Decreasing
Paola	Increasing	Decreasing
Pieta	Increasing	Decreasing

- **Population Density and Poverty Rates**

Once it has been established that offenders tend to cluster in high population density areas, the best way forward to understand what these areas constitute is to look at the relationship between population density and poverty rates and then logically to review offender density with poverty rates. This would help identify consistencies in the population and offender analysis in terms of correlations to poverty.

*Research Question: Is unemployment and poverty higher in more densely populated areas?*

The analysis for poverty is based on risk assessment where unemployment is being used as a surrogate for poverty. Spearman's rho (Table 8.24) indicates a very weak relationship between

population density and poverty at 0.107 and a p at 0.002, which is not significant at the stringent rating of 0.001 used in this study but still significant at  $p = 0.05$ .

*Table 8.24: Crosstabulations and Spearman Correlation Tests for Population Density and Poverty*

**Risk\_Population Density\_Recode \* Poverty\_Risk\_Recode Crosstabulation**

			Poverty_Risk_Recode		Total
			Less than 100	101 to 500	
Risk_Population Density_Recode	Less than 100	Count	90	65	155
		% within Poverty_Risk_Recode	20.6%	16.2%	18.5%
	101 to 500	Count	120	110	230
		% within Poverty_Risk_Recode	27.5%	27.4%	27.4%
501 to 1000	Count	149	101	250	
	% within Poverty_Risk_Recode	34.1%	25.1%	29.8%	
1000 plus	Count	78	126	204	
	% within Poverty_Risk_Recode	17.8%	31.3%	24.3%	
Total		Count	437	402	839
		% within Poverty_Risk_Recode	100.0%	100.0%	100.0%

**Symmetric Measures**

		Value	Asymp. Std. Error <sup>a</sup>	Approx. T <sup>b</sup>	Approx. Sig.
Interval by Interval	Pearson's R	.107	.034	3.116	.002 <sup>c</sup>
Ordinal by Ordinal	Spearman Correlation	.107	.034	3.108	.002 <sup>c</sup>
N of Valid Cases		839			

a. Not assuming the null hypothesis.

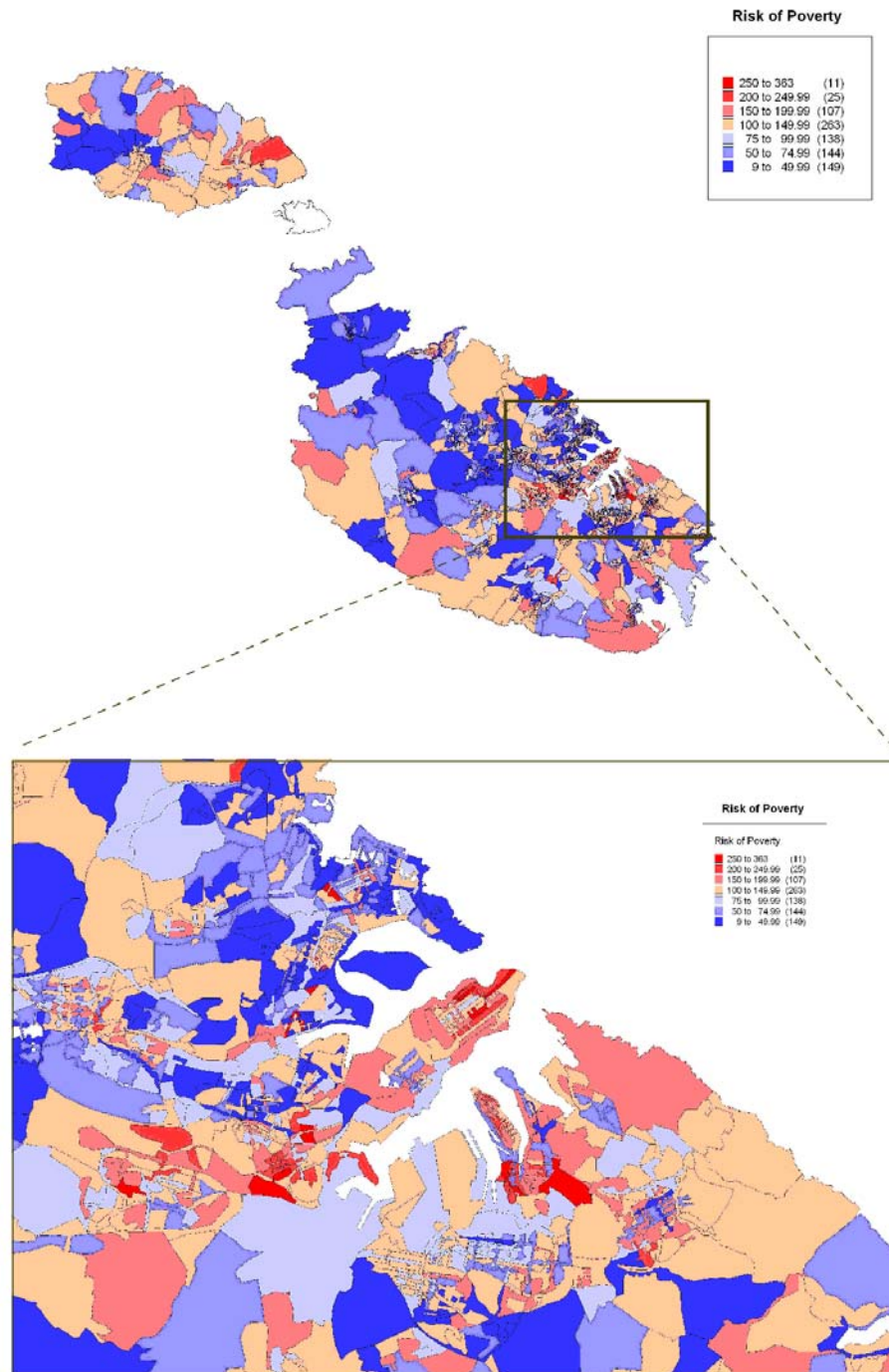
b. Using the asymptotic standard error assuming the null hypothesis.

c. Based on normal approximation.

Results show that 402 or 47.9% of all EAs register a higher than the national poverty rate. This indicates that relative poverty is quite high. When analysing the above-100 poverty group, 16.2% fall within low population density areas with the rest experiencing higher than standard poverty and higher than standard population density. Surprisingly, some areas exhibit huge differences between the expected and the observed poverty data, reaching an extreme of 363 (recoded to 101 to 500 in the Table above) or 3.63 times the expected figure. This is alarming, especially since the worst five areas registering a rate of poverty over 300 are located as follows; an area in Valletta with the 363 figure, followed by another area in Valletta, Marsa, Hamrun, and two areas in Bormla; all areas within the harbour region.

Figure 8.33 identifies those EAs that have a higher than standard poverty rate, the results clearly showing the high rates of poverty within the Grand Harbour region with the main highlights once again being the Three Cities and Valletta. This finding is in line with the Malta Economic Survey (2000), which reports that when compared to a national average, the Grand Harbour area registered drastically lower income.

*Figure 8.33: Graphical Poverty Rate – Enumeration Areas*

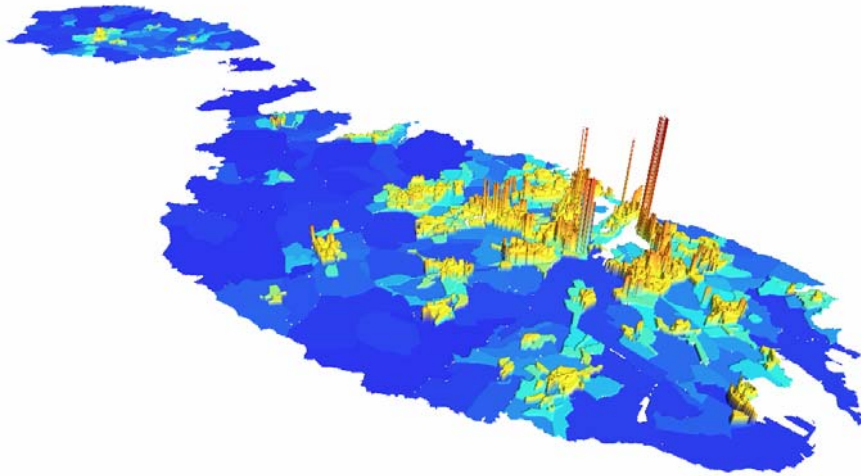




The best way to review this result is to generate a series of maps in 3D that allow both population (Figure 8.34) and poverty (Figure 8.35) to be interpolated with the poverty map overlaid onto the population density. Visual analysis is then carried out to identify if the high-rate offender density colour can be found in the population density spikes (Figure 8.36).

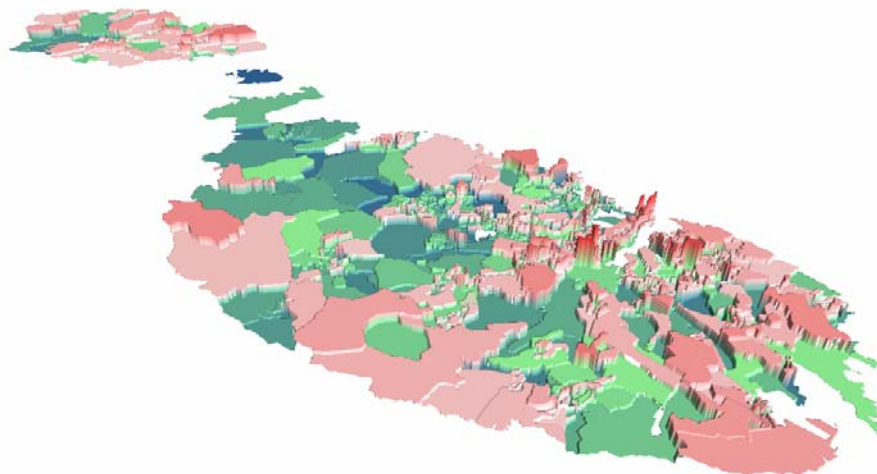
Step 1: The population density map (Figure 8.34) depicts those EAs at the national level of 1,200 persons per square kilometre in blue and the areas that have high densities in red.

*Figure 8.34: 3D population density map – Enumeration Areas*



Step 2: The risk of poverty (Figure 8.35) depicts the EAs that have high poverty as red, green being the national level and blue indicating low poverty.

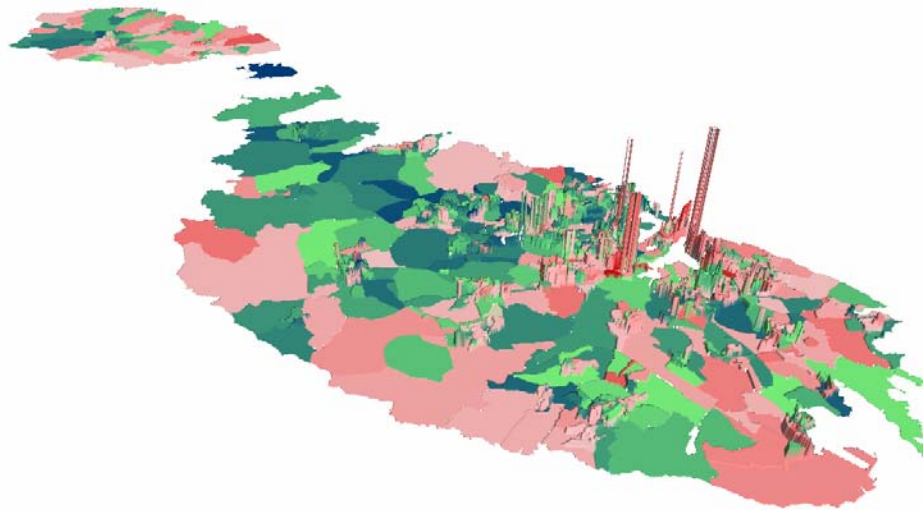
*Figure 8.35: 3D risk of poverty maps – Enumeration Areas*





Step 3: A combination map of Risk of Poverty map draped over a population density map is given in Figure 8.36. The result indicates that the areas of high poverty risk coincide with the areas of high population density, mainly in the areas within the Grand Harbour with red poverty spikes in Figure 8.34 highlighting the red population density spikes in Figure 8.35. Other areas, such as the northern part of the conurbation show that population density there is not related to poverty as most spikes are green in colour mainly representing the national poverty rate.

Figure 8.36: Risk of Poverty map draped over a population density map



As in the case of population/offender densities analysis, a Moran's I exercise shows that at Moran's I of 0.028094 for poverty this is very slightly less clustering than that for population at 0.028428 (Table 8.25). This indicates a very small but lower concentration of poverty rate than would be expected based on population.

Table 8.25: Moran's I spatial statistics tests for Poverty rate and Population density

Poverty rate Moran's I	Population density Moran's I
Spatial Autocorrelation for Point Data:	
Sample size .....: 843	Sample size .....: 843
Measurement type .....: Direct	Measurement type .....: Direct
Start time.....: 11:56:22 AM, 07/20/2006	Start time.....: 11:40:41 AM, 07/20/2006
Moran's "I" .....: 0.028094	Moran's "I" .....: 0.028428
Spatially random (expected) "I" ....: -0.001188	Spatially random (expected) "I" ....: -0.001188
Standard deviation of "I" .....: 0.001468	Standard deviation of "I" .....: 0.001468
Normality significance (z) .....: 19.948440	Normality significance (z) .....: 20.173965
p-value (one tail) .....: 0.0001	p-value (one tail) .....: 0.0001
p-value (two tail) .....: 0.0001	p-value (two tail) .....: 0.0001
Randomization significance (z) .....: 19.950019	Randomization significance (z) .....: 20.176473
p-value (one tail) .....: 0.0001	p-value (one tail) .....: 0.0001
p-value (two tail) .....: 0.0001	p-value (two tail) .....: 0.0001
End time.....: 11:56:23 AM, 07/20/2006	End time.....: 11:40:42 AM, 07/20/2006

- **Offenders and Poverty**

Having found a positive relationship between population and offender density and a subsequent positive relationship between population density and poverty, the next step looks at the potential strength and direction of the offender and poverty relationship, if any.

Research Question: Do poor areas host offenders?

An analysis of offender and poverty relationships show that there is a significant relationship between the two factors at Spearman's rho of 0.18 and a  $p = 0.000$  (Table 8.26). The analysis of offender density and risk of poverty shows that areas with higher than the national standard poverty rate of 0.02 (Figure 8.31) host 52% of all offenders. Half of them again live in zones that have a factor difference (over a 1000 rate as against a national 100). Only a few offenders live in low poverty rate (less than national) areas. In fact 63.9% of those living in areas with less than national poverty rates have less than the national offender densities.

*Table 8.26: Crosstabulations and Spearman Correlation Tests for Offender Density and Poverty Rate*

**Risk\_Offender\_Recode \* Poverty\_Risk\_Recode Crosstabulation**

			Poverty_Risk_Recode		Total
			Less than 100	101 to 500	
Risk_Offender_Recode	Less than 100	Count	278	195	473
		% within Poverty_Risk_Recode	63.9%	48.4%	56.4%
	101 to 500	Count	69	66	135
		% within Poverty_Risk_Recode	15.9%	16.4%	16.1%
501 to 1000	Count	35	38	73	
	% within Poverty_Risk_Recode	8.0%	9.4%	8.7%	
1000 plus	Count	53	104	157	
	% within Poverty_Risk_Recode	12.2%	25.8%	18.7%	
Total		Count	435	403	838
		% within Poverty_Risk_Recode	100.0%	100.0%	100.0%

**Symmetric Measures**

		Value	Asymp. Std. Error <sup>a</sup>	Approx. T <sup>b</sup>	Approx. Sig. <sup>c</sup>
Interval by Interval	Pearson's R	.187	.034	5.506	.000 <sup>c</sup>
Ordinal by Ordinal	Spearman Correlation	.180	.034	5.296	.000 <sup>c</sup>
N of Valid Cases		838			

a. Not assuming the null hypothesis.

b. Using the asymptotic standard error assuming the null hypothesis.

c. Based on normal approximation.

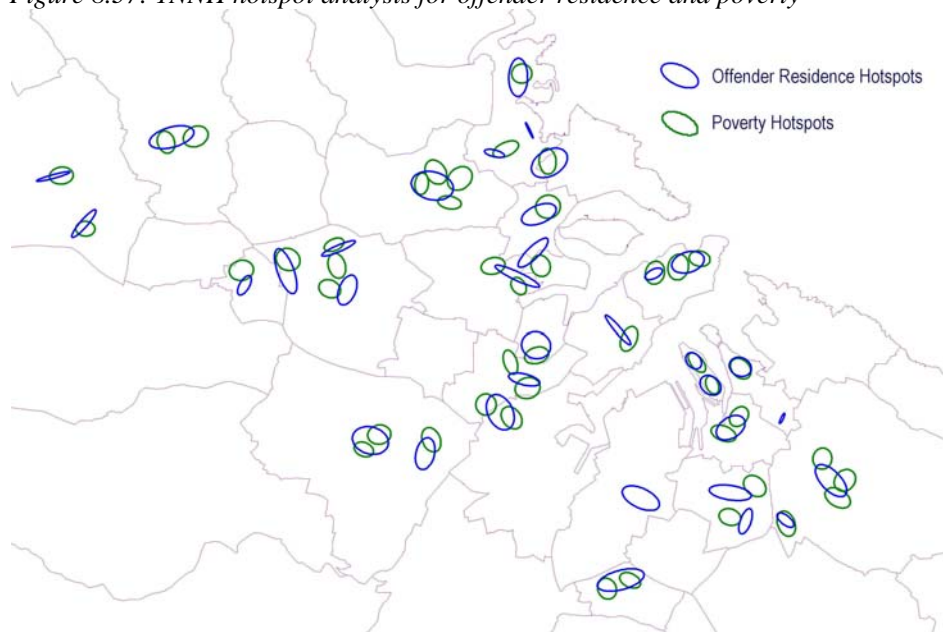
However this is not a direct indication that areas that suffer from poverty directly attract more offenders as areas of residence. The pointers seen in previous sections indicate that 50.8% of

offenders are unemployed, thus this does not mean that all offenders are poor or the areas that they live in poor areas. However, there is an indication that the latter areas tend to attract offenders for a diversity of reasons, amongst them the issue of available residence provision that is either rendered ‘free’ through squatting or through cheap rents, decreasing population and in turn again more available housing and other issues that are not tackled here such as stigma, bias and an acceptable-to-offenders social cohesion, which studies require in-depth qualitative analysis.

In addition, the above situation is enhanced through the previous finding (Table 8.16 and Table 8.23a&b) which showed that 7 councils between them host 45.8% of all offenders and these comprise Bormla, Valletta, Qormi, Gzira, San Giljan, Paola and the small town of Pieta. Such a situation indicates that offenders are grouping in a few towns where they would gauge high on significance in the diverse parameters that those areas are strong in, such as in this case poverty. In the following spatial analysis one can see this bias that the areas where offenders live also host high levels of poverty; though there is no direction which variable is the cause or effect.

A spatial analysis using 1NNH hotspots at 1 standard deviation indicates that 95.2% (37) of the 40 1990s offender hotspots are located within or intersect with poverty areas as identified through the 2003 welfare hotspots (an annual poverty surrogate based on unemployment benefits that serve to update Census data). The results in Figure 8.37 show that those areas that did not overlap are located in southern Birgu, (Vittoriosa), Paola and San Giljan. Others, such as those in Isla, Birgu and Valletta, have near perfect overlap, with others such as San Gwann, Qormi, Gzira, Pieta and Marsa experiences large overlaps.

*Figure 8.37: 1NNH hotspot analysis for offender residence and poverty*



Combining the NNH analysis with Moran's I Spatial Autocorrelation for poverty rate and offender density the results show that there is a clustering of both poverty and offenders, at a Moran's I of 0.028094 for poverty this is higher than that for offenders at 0.009482 (Table 8.27). In effect there is a higher concentration of poor areas than would be expected based on offender rate.

*Table 8.27: Moran's I spatial statistics tests for Poverty risk and Offender rate*

Poverty risk Moran's I	Offender rate Moran's I
Spatial Autocorrelation for Point Data:	
Sample size .....: 843	Sample size .....: 843
Measurement type .....: Direct	Measurement type .....: Direct
Start time.....: 11:56:22 AM, 07/20/2006	Start time.....: 11:50:13 AM, 07/20/2006
Moran's "I" .....: 0.028094	Moran's "I" .....: 0.009482
Spatially random (expected) "I" ....: -0.001188	Spatially random (expected) "I" ....: -0.001188
Standard deviation of "I" .....: 0.001468	Standard deviation of "I" .....: 0.001468
Normality significance (z) .....: 19.948440	Normality significance (z) .....: 7.268992
p-value (one tail) .....: 0.0001	p-value (one tail) .....: 0.0001
p-value (two tail) .....: 0.0001	p-value (two tail) .....: 0.0001
Randomization significance (z) .....: 19.950019	Randomization significance (z) .....: 7.271064
p-value (one tail) .....: 0.0001	p-value (one tail) .....: 0.0001
p-value (two tail) .....: 0.0001	p-value (two tail) .....: 0.0001
End time.....: 11:56:23 AM, 07/20/2006	End time.....: 11:50:14 AM, 07/20/2006

### Summary of the offender and poverty relationship

An analysis of offenders and their environment results in a positive relationship between offender density and population density. A spatial study shows that the areas experiencing both high densities are those localities found in the harbour region, those areas that form part of the so-called inelastic cities (Shaw-Taylor, 1998). Whilst population density and poverty resulted in a very weak relationship, a further analysis shows that there is a positive relationship between offender density and poverty risk indicating a tendency for offenders to live in poor areas.

### 8.3 What are the offence aspects that have an impact on social parameters?

Following a review of the offender-related parameters and how they relate to residence location and poverty, the next section seeks to look at the offences these offenders committed and the offences' relationships with the social parameters.

This set of questions analyses the issue of offences as they occur within residential spaces. The main aim is to elicit whether there is a relationship between dwelling types and crime. The main structural variables that will be analysed against offences include population densities, vacant

dwelling densities and dwelling types. Finally the study looks at the relationship between offences and poverty.

- **Offences and Population Density**

As in the offender density analysis, the first parameter analysed is population density.

*Research Question: Are crimes more prevalent in high-density residential areas (high population density) than sparsely populated areas?*

A Spearman's rho of -0.237 and p of 0.000 test proves that there is a significant though weak negative relationship between offences and population density (Table 8.28). This is evident with the highest offence rates (at 1 factor of the national) falling within the areas that have less than national standard population density rates. This may indicate some sparsely or less populated areas that attract a larger number of offences. However, the widest consistent offence densities can be found across the population density spectrum within the 101 to 500 rate offence category.

*Table 8.28: Crosstabulations and Spearman Correlation Tests for Poverty risk and Dwelling density*

**Risk\_Offences \* Risk\_Population Density\_Recode Crosstabulation**

			Risk_Population Density_Recode				Total
			Less than 100	101 to 500	501 to 1000	1000 plus	
Risk_Offences	Less than 100	Count	94	146	184	180	604
		% within Risk_Population Density_Recode	61.0%	62.7%	74.5%	88.2%	72.1%
	101 to 500	Count	50	75	61	24	210
		% within Risk_Population Density_Recode	32.5%	32.2%	24.7%	11.8%	25.1%
	501 to 1000	Count	6	9	2	0	17
		% within Risk_Population Density_Recode	3.9%	3.9%	.8%	.0%	2.0%
	1000 plus	Count	4	3	0	0	7
		% within Risk_Population Density_Recode	2.6%	1.3%	.0%	.0%	.8%
Total		Count	154	233	247	204	838
		% within Risk_Population Density_Recode	100.0%	100.0%	100.0%	100.0%	100.0%

**Symmetric Measures**

		Value	Asymp. Std. Error <sup>a</sup>	Approx. T <sup>b</sup>	Approx. Sig.
Interval by Interval	Pearson's R	-.246	.029	-7.334	.000 <sup>c</sup>
Ordinal by Ordinal	Spearman Correlation	-.237	.031	-7.050	.000 <sup>c</sup>
N of Valid Cases		838			

a. Not assuming the null hypothesis.

b. Using the asymptotic standard error assuming the null hypothesis.

c. Based on normal approximation.

A further detailed analysis based on offences occurring within the different zoning categories depicts interesting findings that explain the weak negative relationship identified above. Table 8.29 shows that the high density areas making up the residential zones take up a 44% (43,931 offences from 1998 to 2003) share of all offences as compared to the non-residential areas. The yellow section of the table indicates that whilst there is no zoning difference in serious crimes, the non-serious crime category shows a shift to the non-residential areas of 56% (54,108). Interestingly, the cyan section shows marked differences in offence structure by unique crime category where residential areas predominate in such offences as ‘violence against the person’ (52%), ‘serious wounding’ (56%) and ‘burglaries from dwellings’ (57%). The rest are predominant in the non-residential low-density areas which offences are related to the activity-role the areas have such as industry, commercial and recreation, social and community facilities, and other urban-rural activities (refer to Chapter 9 Section 9.5.1 for more detailed zoning analysis).

One point of discussion here relates to the ‘burglaries from dwellings’ (43%) registered in non-residential areas. Though Malta’s zoning patterns are distinct in most areas, there is a high level of mixed use, thus one can still find some residential units areas such as those designated as commercial. The main bulk of the ‘burglaries from dwellings’ however occurs in the areas designated as Limits to Development which are earmarked for urban development and are slowly being built, though the concentrations of development type has yet to be ascertained. Dwellings can be found in the zone but the densities are still small enough for the areas to be calculated within the low-density residential areas category.

The results are in contrast to the findings of Entorf *et al* (2000), who had found a high association between population density and violent crime, though the 50% score serious crime score for the Maltese also does not support Wang’s (1999) argument that high population density reduces crime. Malta’s position is unique until more data is available post 2003.

- **Offences and Vacant Dwellings**

As indicated in Chapter 5, vacant dwellings in the Maltese Islands made up 23% of the total stock during the 1995 Census, with a growth potential that outstrips demand. This means that with the original vacant stock plus an average of 6000 new annual units granted between 2000 and 2005 the potential for abuse within this stock is growing steadily. The rapid increase in the resultant vacant dwellings may lead to deterioration of the stock, particularly in the old cores as well as in the new build, which do not get furnished.

Table 8.29: Percentage Reported Offences by Zoning: 1998 – 2003: by seriousness and unique offence categories

Percentage Reported Offences by Zoning Category: 1998-2003																		
Zoning Description	Serious	Non-Serious	Total	Homicide	Violence Against Person	Serious Wounding	Other Violence	Common Assault	Sexual Offences	Burglary Dwelling	Burglary Other	Vehicle Crime	Other Theft	Theft Commercial Recreation	Criminal Damage	Fraud and Forgery	Drugs Offences	Other Offences
Apartments	34	31	31	32	36	36	30	27	32	35	6	32	28	35	29	29	29	35
Terraced Houses	13	10	10	11	12	15	11	7	9	13	5	9	9	5	12	9	15	6
Villas	3	3	3	2	4	4	2	2	2	6	0	4	2	2	3	1	3	2
Bungalows	0	0	0	0	0	0	0	0	0	2	0	0	0	0	0	0	0	0
Farmhouses	0	0	0	0	0	0	0	0	0	0	0	0	0	0	1	0	0	1
<b>Residential Share of Offences %</b>	<b>50</b>	<b>44</b>	<b>44</b>	<b>45</b>	<b>52</b>	<b>56</b>	<b>44</b>	<b>36</b>	<b>44</b>	<b>57</b>	<b>10</b>	<b>46</b>	<b>41</b>	<b>42</b>	<b>45</b>	<b>40</b>	<b>47</b>	<b>44</b>
<b>Residential Share of Offences Total</b>	<b>1,310</b>	<b>42,621</b>	<b>43,931</b>	<b>21</b>	<b>157</b>	<b>618</b>	<b>2,210</b>	<b>211</b>	<b>365</b>	<b>2,346</b>	<b>45</b>	<b>11,706</b>	<b>9,924</b>	<b>4,432</b>	<b>10,845</b>	<b>438</b>	<b>149</b>	<b>464</b>
Zoning Description	Serious	Non-Serious	Total	Homicide	Violence Against Person	Serious Wounding	Other Violence	Common Assault	Sexual Offences	Burglary Dwelling	Burglary Other	Vehicle Crime	Other Theft	Theft Commercial Recreation	Criminal Damage	Fraud and Forgery	Drugs Offences	Other Offences
Social Community Facilities	3	3	3	0	4	2	3	6	3	2	1	3	5	2	3	3	4	4
Recreation	6	7	7	11	6	3	11	11	9	4	1	5	8	15	6	9	8	10
Commercial Areas	13	14	14	17	12	12	16	19	15	11	7	12	14	16	13	26	14	16
Country Parks	0	1	1	2	0	0	0	1	1	0	0	1	0	0	1	0	0	0
Industrial Areas	1	2	2	2	1	1	1	1	2	0	53	2	2	1	2	1	0	1
Limits to Development: unbuilt areas	21	21	21	21	17	24	19	20	20	20	9	23	20	16	21	18	19	19
Rural	5	8	8	2	8	3	6	6	6	5	17	7	10	9	9	3	8	6
<b>Non-Residential Share of Offences %</b>	<b>50</b>	<b>56</b>	<b>56</b>	<b>55</b>	<b>48</b>	<b>44</b>	<b>56</b>	<b>64</b>	<b>56</b>	<b>43</b>	<b>90</b>	<b>54</b>	<b>59</b>	<b>58</b>	<b>55</b>	<b>60</b>	<b>53</b>	<b>56</b>
<b>Non-Residential Share of Offences Total</b>	<b>1,293</b>	<b>54,108</b>	<b>55,401</b>	<b>26</b>	<b>143</b>	<b>493</b>	<b>2,805</b>	<b>369</b>	<b>462</b>	<b>1,737</b>	<b>387</b>	<b>13,741</b>	<b>14,493</b>	<b>6,173</b>	<b>13,146</b>	<b>664</b>	<b>169</b>	<b>593</b>
<b>Total (All Zoning) Offences</b>	<b>2,603</b>	<b>96,729</b>	<b>99,332</b>	<b>47</b>	<b>300</b>	<b>1,111</b>	<b>5,015</b>	<b>580</b>	<b>827</b>	<b>4,083</b>	<b>432</b>	<b>25,447</b>	<b>24,417</b>	<b>10,605</b>	<b>23,991</b>	<b>1,102</b>	<b>318</b>	<b>1,057</b>

The new Census 2005 enable the analysis of crime in relation to the vacant areas, in line with broken windows theory and Skogan's (1986, 1990) assertion that where the physical decay is related to social disorganisation. Though vacant dwellings in Malta do not necessarily mean decayed buildings, further analysis would identify just the deteriorated dwellings and their relationship to crime.

**Research Question: Are high rates of vacant dwellings related to high levels of crime?**

A significance test was carried out based on data from the Water Services Corporation that lists all dwelling units by habitation type, which Spearman's rho at 0.149 and a p of 0.000 indicating a weak positive relationship between offences and vacant dwellings (Table 8.30). The results show that little crime occurs in areas that have less than the national standard vacancy rate though it increases within areas that have higher rates of vacancies. Most vacancy rate categories have low offence rates which increases slowly as vacancy rates increase.

*Table 8.30: Crosstabulations and Spearman Correlation Tests for Offences and Vacant Dwelling density*

**Risk\_Offences \* Risk\_Vacancies\_Recode Crosstabulation**

			Risk_Vacancies_Recode			Total
			Less than 100	101 to 500	501 to 1000	
Risk_Offences	Less than 100	Count	413	187	1	601
		% within Risk_Vacancies_Recode	76.9%	63.0%	100.0%	72.0%
	101 to 500	Count	113	97	0	210
		% within Risk_Vacancies_Recode	21.0%	32.7%	.0%	25.1%
501 to 1000	Count	8	9	0	17	
	% within Risk_Vacancies_Recode	1.5%	3.0%	.0%	2.0%	
1000 plus	Count	3	4	0	7	
	% within Risk_Vacancies_Recode	.6%	1.3%	.0%	.8%	
Total	Count	537	297	1	835	
	% within Risk_Vacancies_Recode	100.0%	100.0%	100.0%	100.0%	

**Symmetric Measures**

		Value	Asymp. Std. Error <sup>a</sup>	Approx. T <sup>b</sup>	Approx. Sig.
Interval by Interval	Pearson's R	.144	.035	4.195	.000 <sup>c</sup>
Ordinal by Ordinal	Spearman Correlation	.149	.035	4.338	.000 <sup>c</sup>
N of Valid Cases		835			

a. Not assuming the null hypothesis.

b. Using the asymptotic standard error assuming the null hypothesis.

c. Based on normal approximation.

Moran's I Spatial Autocorrelation for Point Data for these rates again indicates the presence of clustering. Moran's I of 0.015844 for offences is less than that for vacancies at 0.030336 (Table 8.31). This indicates that there is a slightly lower concentration of offences than would be expected based on vacancies.



Table 8.31: Moran's I spatial statistics tests for Offence risk and Vacant Dwelling density

Offence rate Moran's I	Vacant Dwelling density Moran's I
Spatial Autocorrelation for Point data:	
Sample size .....: 843	Sample size .....: 843
Measurement type .....: Direct	Measurement type .....: Direct
Start time.....: 12:08:38 PM, 07/20/2006	Start time.....: 12:00:59 PM, 07/20/2006
Moran's "I" .....: 0.015844	Moran's "I" .....: 0.030336
Spatially random (expected) "I" .....: -0.001188	Spatially random (expected) "I" .....: -0.001188
Standard deviation of "I" .....: 0.001468	Standard deviation of "I" .....: 0.001468
Normality significance (z) .....: 11.602729	Normality significance (z) .....: 21.475431
p-value (one tail) .....: 0.0001	p-value (one tail) .....: 0.0001
p-value (two tail) .....: 0.0001	p-value (two tail) .....: 0.0001
Randomization significance (Z) .....: 11.690668	Randomization significance (Z) .....: 21.509080
p-value (one tail) .....: 0.0001	p-value (one tail) .....: 0.0001
p-value (two tail) .....: 0.0001	p-value (two tail) .....: 0.0001
End time.....: 12:08:38 PM, 07/20/2006	End time.....: 12:01:00 PM, 07/20/2006

- **Offences and Dwellings Type**

Following a confirmation that low densities and vacant areas attract higher offences, the next step attempts to identify the types of zones that attract the offences.

In order to check for relationships between offence and residential dwelling types it is necessary to look at the available data and run a series of density tests by dwelling category. Dwellings are categorised as per established nomenclatures used by NSO and EUROSTAT. The tests were based on both the convicted offenders' offences (COTC Offences) as well as the crimes reported to the police (GEOPOL) as found within a residential zoning spatial layer created for this purpose through a series of buffering, overlaying and cutting queries.

Figure 8.38: Dwelling type zones

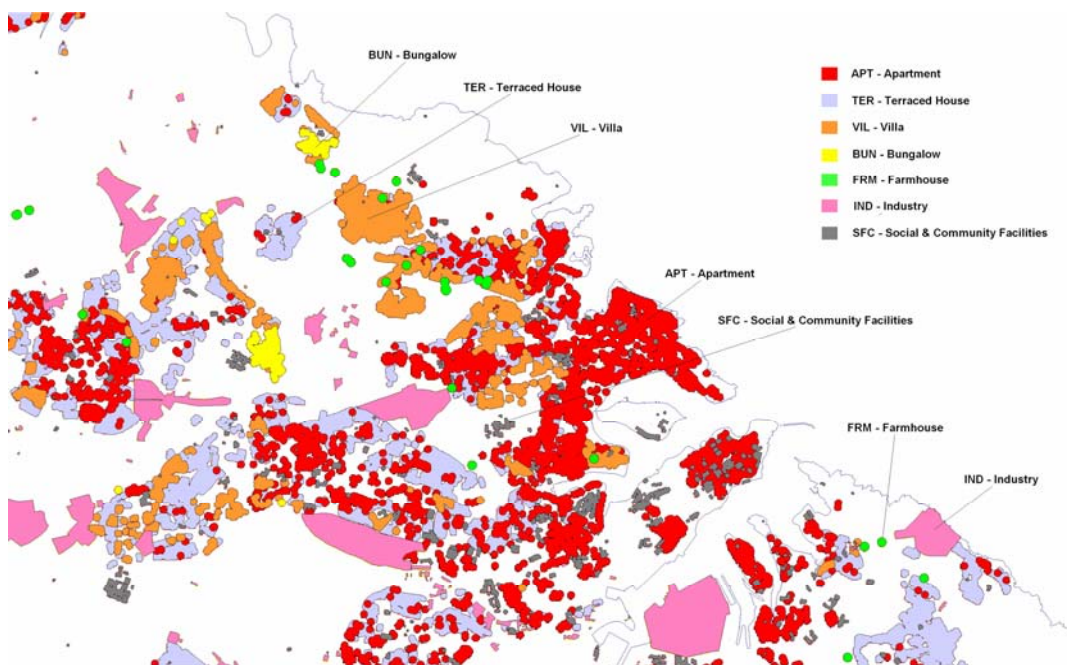


Figure 8.38 depicts a detail of such areas. Each colour represents a different zoning type as indicated in the map: red shows those areas predominantly taken up by apartments, blue by terraced housing, orange by villa areas, yellow by bungalows and green by farmhouses. Other colours indicate areas such as industry (pink) and social-community facilities (grey) that are not used in this theme study. The main aim is to run a density study on offences registered by the police and the known 1990s offenders to gauge the preferred areas for residential offences.

*Research Question: Do different dwelling type zones exhibit different crime rates?*

Malta is a highly dense country both in terms of population and development uptake leading to 21% soil-sealed by 1995 (Planning Authority, 2002). Development of dwellings is very high and rapid leading to large areas being developed for apartments, terraced housing, maisonettes and a variety of high-end units such as villas and bungalows. Each category tends to group in close proximity to their type both through choice and schemed zone requirements. Each category attract different rates of residential offences, though apartments by far exceed the rest. In fact, basing a GIS study of police-reported offences (GEOPOL) by area taken up by each dwelling type, apartments overtake the sum of all the other categories' densities by three times (Table 8.19 and Table 8.32).

*Table 8.32: GEOPOL and COTC Offence Densities by Dwelling Type*

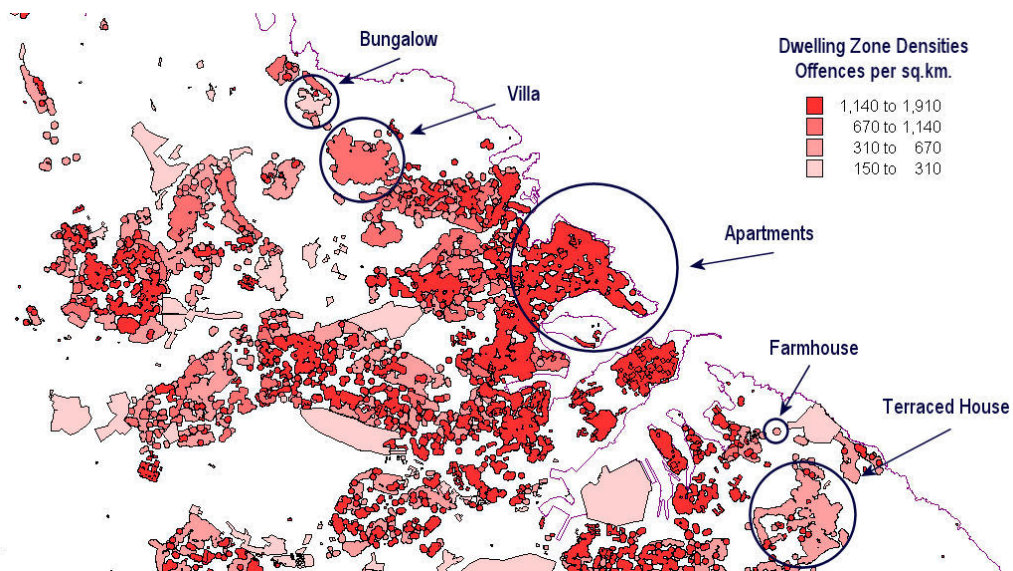
Zoning	GEOPOL Counts	GEOPOL % Offence by Dwelling Type	COTC Offence Counts	Area sq.km.	GEOPOL Densities	COTC Offence Density
<b>APT</b>	30,539	69.5	654	16.01	1,907.82	40.86
<b>TER</b>	9,698	22.1	102	19.23	504.37	5.30
<b>VIL</b>	3,017	6.9	18	4.48	673.31	4.02
<b>BUN</b>	314	0.7	1	1.11	282.09	0.90
<b>FRM</b>	363	0.8	8	1.16	313.83	6.92
<b>Total Dwellings</b>	<b>43,931</b>	<b>100</b>	<b>783</b>	<b>41.99</b>	<b>1,046.32</b>	<b>18.65</b>

This indicates that apartments serve as the main areas where crimes occur followed by villas, terraced dwellings, farmhouses and bungalows in that order. This also indicates that areas of high dwelling densities are prone to more offences than low density and more affluent areas. High affluence units such as villas, farmhouses and bungalow areas register 8.4% of residential burglaries occurring in all the residential areas. Apartments host 69.5%, whilst terraced houses host 22.1%. Such results indicate that the affluent dwelling types attract crime though at relatively small rates. Wikstrom's (1991) assertion that residential burglaries tend to occur in areas of high-socio-economic status is not readily verified in the Maltese construct particularly

due to the fact that apartments have recently become the main development type and figures are not yet available on their economic status.

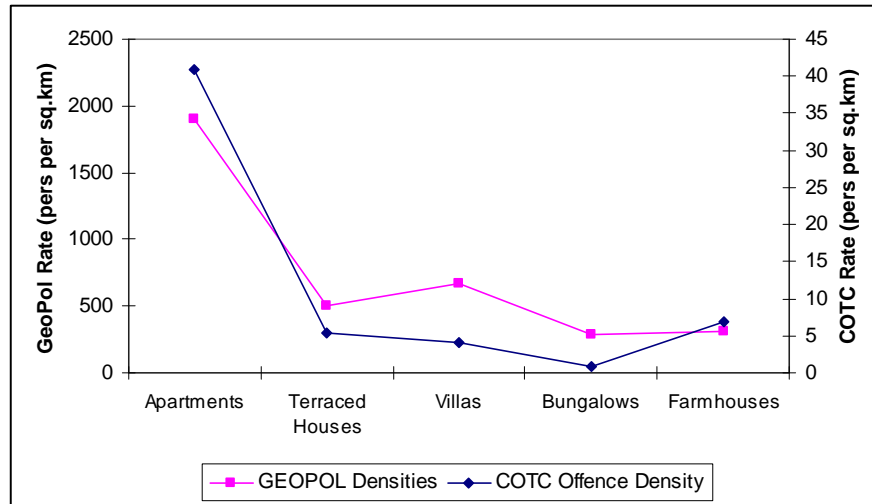
Figure 8.39 depicts an offence density map showing the different densities for the different dwelling categories with the highest densities appearing in the apartment zones as highlighted in Figure 8.38. The map shows a rendition of the dwelling zones by dwelling density and replicates the finding that the highest density areas are those listed as apartments in the darkest red, whilst the least taken up by bungalows. Interestingly terraced houses are less of a target than villas presumably because of the latter's more exclusive and isolated status and perceived high affluence, however until such data is made available on goods and values stolen such an assumption is difficult to verify.

*Figure 8.39: Offence categories by dwelling type zones*



An additional analysis was carried out on the same lines as above (Table 8.32), which attempts to analyse if there is a relationship between offences reported to the police (GEOPOL 1998-2003) and patterns exhibited by known offenders (COTC). This analysis between offences reported to the police and dwelling type was replicated for offences committed by convicted offenders in the 1990s. The result (Figure 8.40) is highly similar, showing the same trends in offence densities by dwelling type, albeit at a smaller density, intrinsically due to the small parameter involved (2,154 convicted against 99,575 police reports). The results indicate that the persons in prison may form a representative sample to gauge offence location, though further study is required based on this finding.

Figure 8.40: GEOPOL and COTC Offence Densities by Dwelling Type



- **Offences and Village Cores**

Following an analysis of offences as against various residential categories at a national level, the next section looks at the relationship between crime and the officially designated areas, focusing on the issue of village cores.

*Research Question: How far is crime concentrated around the village cores?*

As in the case of offender analysis, analysing offences based around the village cores and their 100m buffer areas, one can see that the UCA\_VC areas host most offences with decreasing rates the further out one moves from the boundaries (Figure 8.41). The results show that there is a similar trend for offences reported to the police and offences committed by convicted offenders.

However, in contrast to the poverty structure, where the UCA had lower rates than its immediate boundary, the offence categories sees the cores as having the highest rate of offender residences as well as offences occurring therein. The figures range from 33% of all offences reported to the police with another 21% and 10% in the immediate 100m and 200m boundaries totalling 64% of the offences registered within 1km from the town centre (Table 8.33). This figure is nearly replicated by the known offenders' offences which totalled 78% in the same areas with 49% committed within the cores, thus indicating a higher propensity for these offenders to predate in the centres. Considering that offences within the core boundaries comprise 90% (89,492) of all registered crime, the village cores are the main attractors for the larger part of all offences, particularly so for known offenders.

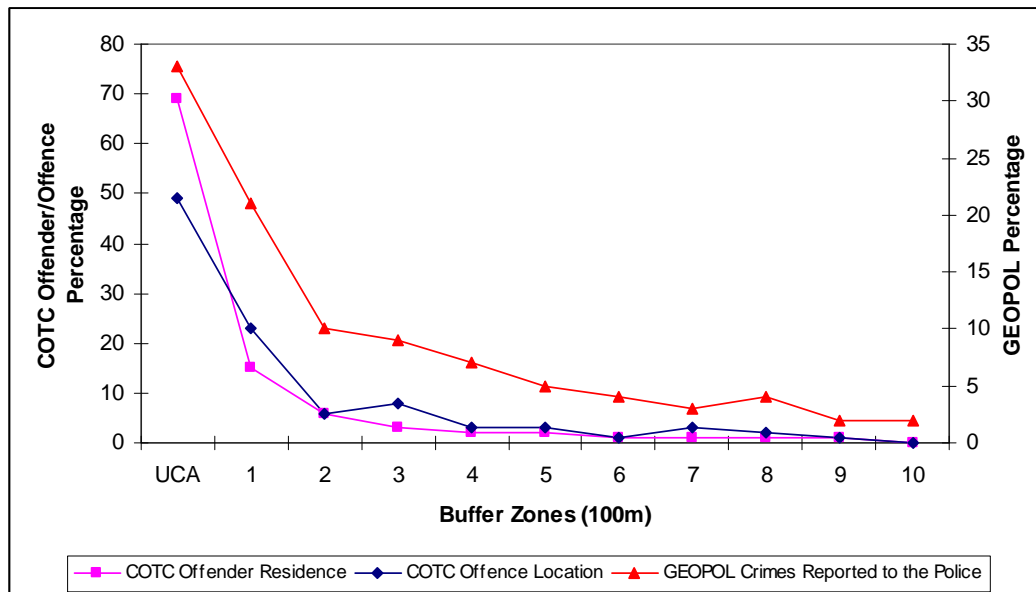
Table 8.33: GEOPOL and COTC Offence committed within UCAs and their boundaries

	Buffer Radius	GEOPOL Crimes Reported to the Police	GEOPOL Crimes Reported to the Police %	COTC Offender Residence	COTC Offender Residence%	COTC Offence Location	COTC Offence Location %
UCA	0m	29583	33	5047	69	655	49
1	100m	18997	21	1074	15	314	23
2	200m	9073	10	407	6	80	6
3	300m	7831	9	247	3	105	8
4	400m	6475	7	160	2	42	3
5	500m	4259	5	113	2	40	3
6	600m	3676	4	66	1	17	1
7	700m	2532	3	60	1	34	3
8	800m	3212	4	68	1	32	2
9	900m	2163	2	46	1	14	1
10	1000m	1691	2	30	0	5	0

Research Question: How does crime change with distance from the cores?

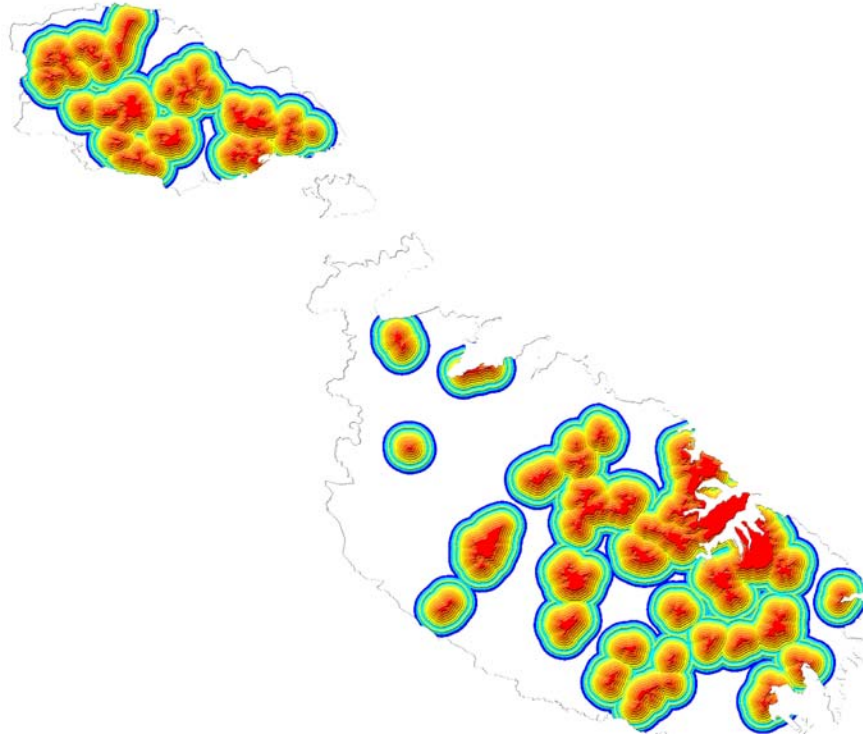
As described above, the inner sectors of the village cores host most offences, however further detailed analysis shows that offences do diminish in number the further one moves from the cores, namely away from the social and community centres, retail areas and moves into the residential areas of a town. As Table 8.33 indicates offences gradually die out by the tenth buffer indicating that most offences in reality occur within a very short distance from the centre where up to 73 percent of offences occur within 300m of a core (Figure 8.41). This finding is an effective tool for decision makers to concentrate their efforts in a relatively small area in comparison to the rest of the islands, considering that this area totals 70 sq.km (inclusive of entire areas Valletta and the Three Cities) from the total 316 sq.km.

Figure 8.41: Offence Rate across the UCA\_Village Cores buffer zones

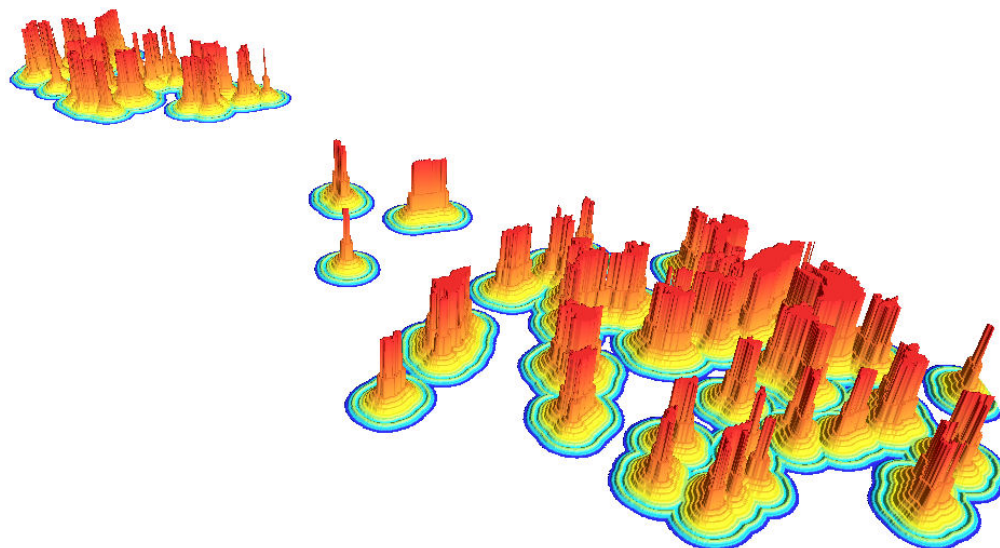


Graphical representations in top and 3D perspectives are given in Figures 8.42a&b. The red zones represent the highest density areas ranging towards the blue (least) through yellow. The 3D perspective shows clearly the rate at which offences drop the further they move away from the red centre (UCA\_VC boundary).

*Figure 8.42a: Offence densities: top perspective*



*Figure 8.42b: Offence densities: 3D perspective*





- **Offences and Social Community Structures**

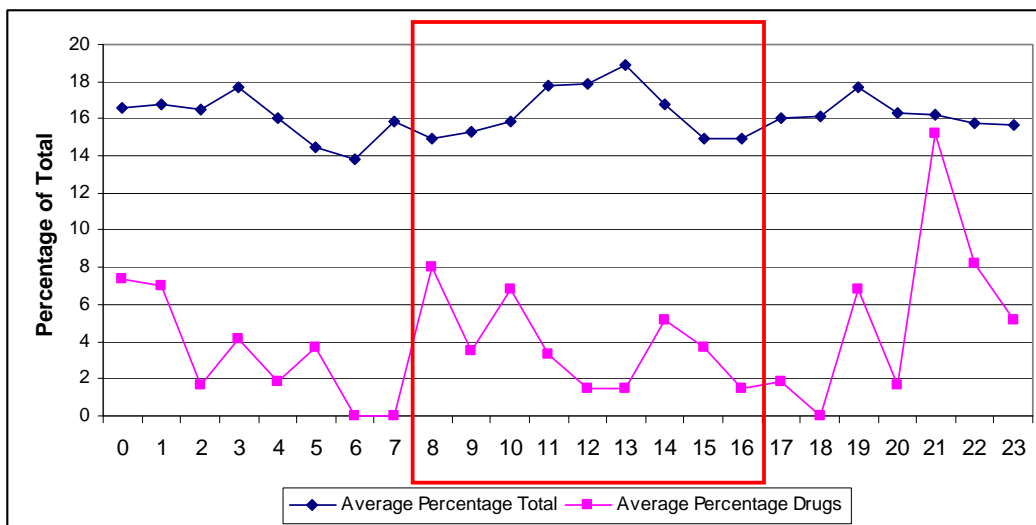
Along with landuse parameters that directly impinge on the social and environmental aspects of a society there are other more specific categories that have a direct relationship to offences. One spatial unit that was identified in the literature review concerned the other socially-specific area of education. This was highlighted due to its intrinsically critical importance in the identification of incidence of crime that relates to young victims. Maltese legislation states that any crime occurring within 100m of a school would induce harsher penalties, at least one sentence grade higher for serious crimes. This section looks at the total offences and then analyses drugs as the serious crime of choice.

*Research Question: Do most crimes occur within close-proximity to socially-sensitive locations such as schools?*

In the case of total crimes, an average of 16.2% of all offences are located within close proximity to schools averaging 2,700 offences in the buffer area out of an annual average of 16,600 offences for the GEOPOL period of 1998 to 2003.

Interestingly, since the areas taken up by schools fall within other areas that may harbour different uses such as leisure areas, a case in point being Paceville and Sliema, this analysis elicits the need to review crime by time. In view of this, generic crime and drugs offences were analysed against time in hours. This was taken as a percentage of the crimes within the educational zones by time.

*Figure 8.43: Offences within 100m buffer of all school locations in the Maltese Islands between 1998 and 2003*



The result depicted in Figure 8.43 shows that over the GEOPOL period (1998-2003) there was a high rate of general crimes within the school period particularly around 12:00 to 13:00 (break time) though this was not replicated in the case of drugs which was very low during this time. On a day average, offences reported in the buffer zones during the school time were less than total offences (12% against 16.1%) whilst drugs registered 3.9% against 4.3% during the period.

- **Offences and Unemployment/Poverty**

As analysed in the offender to poverty relationship, an offence to poverty relationship is necessary to the extent of identifying the main areas that attract crime and whether they have a poverty construct.

*Research Question: Is there a strong relationship between offence locations and areas of high unemployment?*

In an attempt to analyse whether there is any relationship between areas of high unemployment and where offenders commit crime, a test was carried out on risk of poverty and risk of offence, a Spearman's rho of -0.024 and a p >0.001 at 0.493 shows that there is no relationship between areas of high poverty and offence locations (Table 8.34).

*Table 8.34: Crosstabulations and Spearman Correlation Tests for Poverty risk and Offence rate*

**Risk\_Offences ' Poverty\_Risk\_Recode Crosstabulation**

			Poverty_Risk_Recode		Total
			Less than 100	101 to 500	
Risk_Offences	Less than 100	Count	309	295	604
		% within Poverty_Risk_Recode	71.2%	73.4%	72.2%
	101 to 500	Count	113	96	209
		% within Poverty_Risk_Recode	26.0%	23.9%	25.0%
	501 to 1000	Count	8	8	16
		% within Poverty_Risk_Recode	1.8%	2.0%	1.9%
	1000 plus	Count	4	3	7
		% within Poverty_Risk_Recode	.9%	.7%	.8%
Total		Count	434	402	836
		% within Poverty_Risk_Recode	100.0%	100.0%	100.0%

**Symmetric Measures**

		Value	Asymp. Std. Error <sup>a</sup>	Approx. T <sup>b</sup>	Approx. Sig.
Interval by Interval	Pearson's R	-.022	.035	-.626	.532 <sup>c</sup>
Ordinal by Ordinal	Spearman Correlation	-.024	.035	-.686	.493 <sup>c</sup>
N of Valid Cases		836			

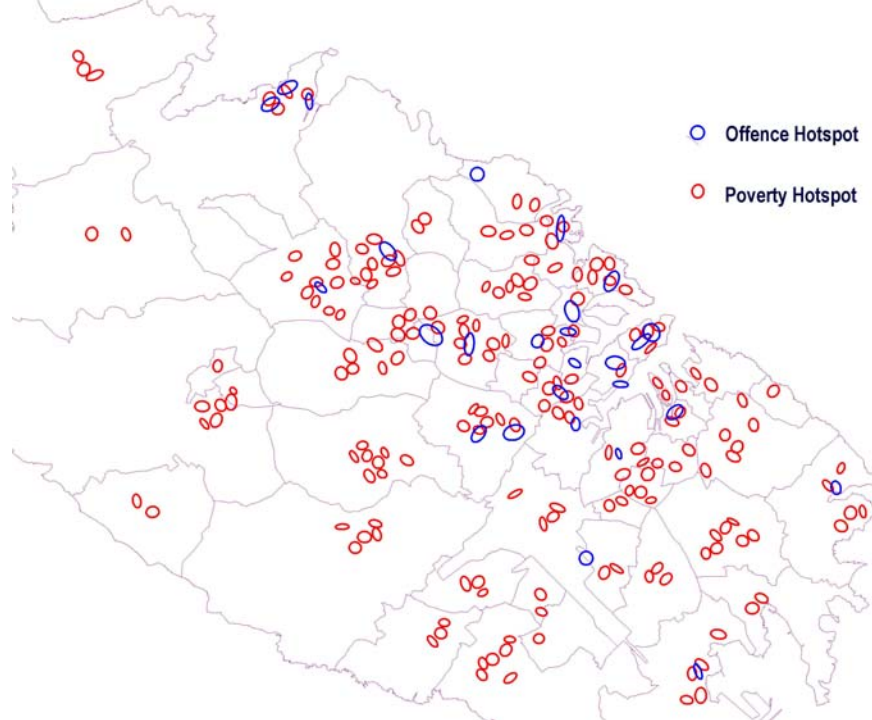
- a. Not assuming the null hypothesis.
- b. Using the asymptotic standard error assuming the null hypothesis.
- c. Based on normal approximation.



Further spatial Hotspot analysis of poverty and offences committed therein shows that the offence clusters are radically different from the poverty ones, in that there are fewer offence hotspots as against poverty hotspots as shown in Figure 8.44, primarily due to the concentrated areas that opportunities are located in, already discussed such as the high rates of offences in recreational areas and commercial areas. The offence hotspots immediately bring to mind the evident relationship between offences and the specific areas such as Paceville in San Giljan, Valletta commercial area, industrial areas and other leisure-oriented areas such as Qormi, Marsascala and Birzebbugia.

A cross poverty-offence analysis shows that very few poverty hotspots intersect with offence hotspots at 1 Standard Deviation; in fact only 10.8% do so. However, taking a perspective of offence hotspots shows that 75.9% of them intersect with poverty areas, though mainly in places such as San Pawl il-Bahar which has a mixture of residential and leisure areas.

*Figure 8.44: Offences and Poverty hotspots: 1998-2003*



### **Summary of the offence relationship**

In summary, offences committed by convicted offenders fall within increasingly high dwelling concentrations, particularly apartment areas, low population density areas, occur in vacant dwelling concentrations and are mostly found within areas zones for apartments. They are also to

be found in Urban Conservation Areas, linked to specific social and community areas such as schools though not for serious crimes. Finally very few high-poverty areas serve as crime attractors.

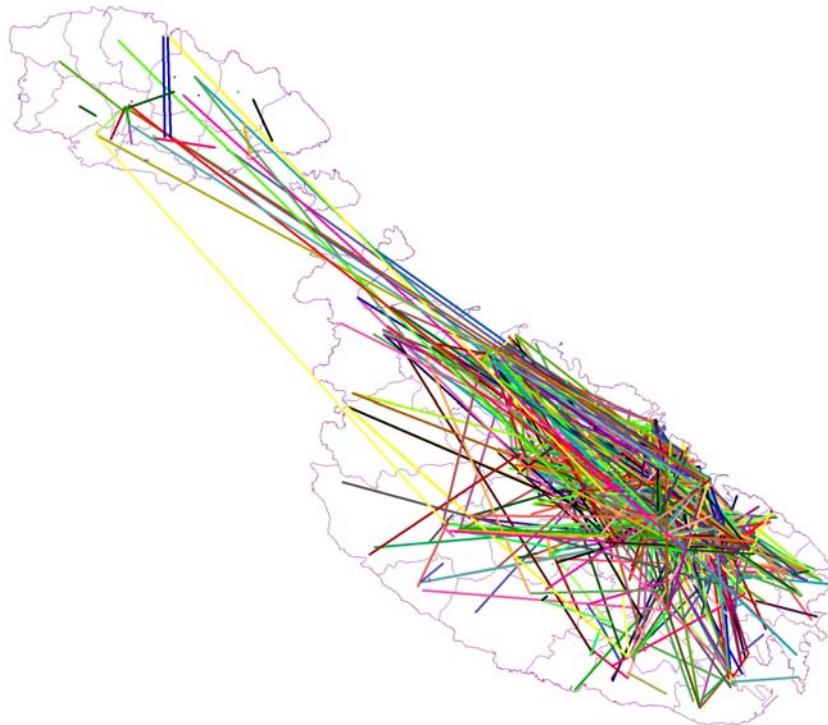
#### 8.4 The Offender-Offence Relationship

Following the offender and offence analysis and their unique relationship to poverty and other social parameters, this final section looks at the direct offender-offence relationship, targeting the offender's journey to crime and the distance they travel should they commission crime close to their residence location.

*Research Question: Do offenders commit crimes close to where they live?*

An analysis of journey to crime shows that there is a multifaceted structure in the Maltese offender-offence movements. Using a spider-graphing methodology enables the generation of the convicted 1990s offender to offence relationship web, as depicted in Figure 8.45. The result of such a web allows for the generation of distance calculations based on Euclidian distance. Lacking the availability of a properly-networked digital street network, which does not yet exist in Malta, Euclidian analysis was chosen, which gives a relative indication of the actual distance traveled.

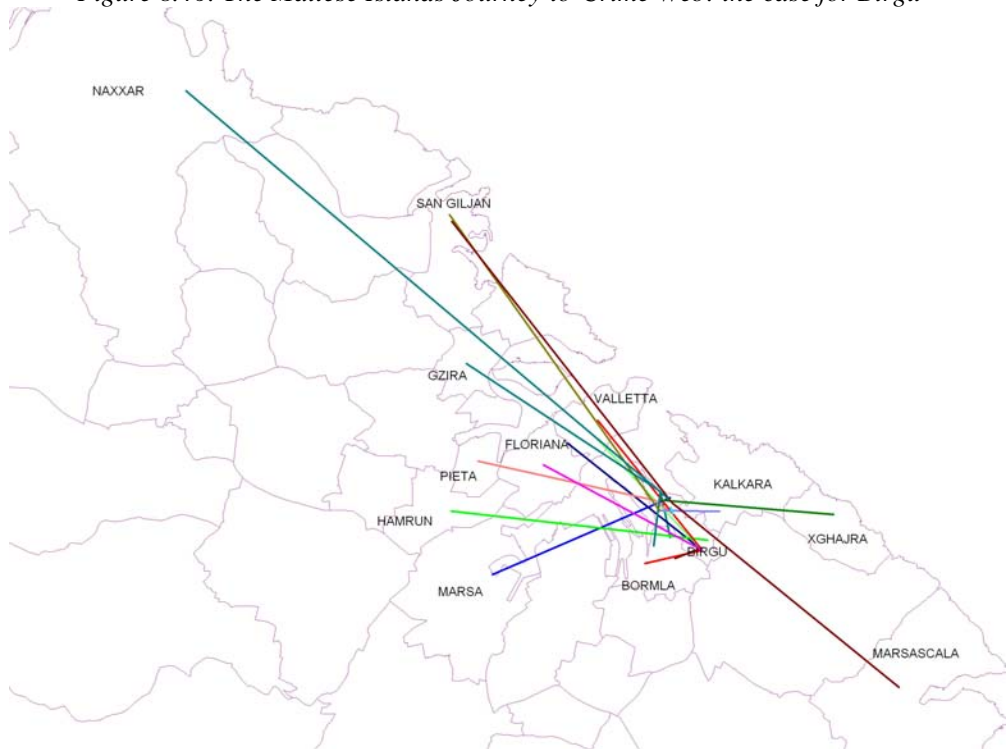
*Figure 8.45: The Maltese Islands Journey-to-Crime Web*



To help unravel the complex Maltese Islands web, a case type analysis of convicted 1990s offenders-offence travel is given for Birgu. Figure 8.46 shows the distances travelled more clearly than Figure 8.45. It shows that the Birgu offenders travelled mainly throughout the eastern part of the islands, within the harbour regions and even to the recreational areas of San Giljan and Marsascala, though rarely to Western and North Western localities.

A similar exercise for future study should be carried out by locality, type of offence, time and day. Such an analysis would help in the identification of potential offender turf, mode of transport, type of target, etc. Since this study is more concerned with a high-level study of this topic, journey-to-crime was only reviewed at national level with one depiction of a locality. To carry out an intensive study of the magnitude indicated for future study, one must carry out a highly complex study based on individual offender analysis against each of the variables indicated. Such is too large a scope considering that the 1990s data comprises 2,227 offenders and was considered too time consuming for this research. However, the results of such a study would effectively serve both academic purposes as well as serve an operational scope for Police uptake.

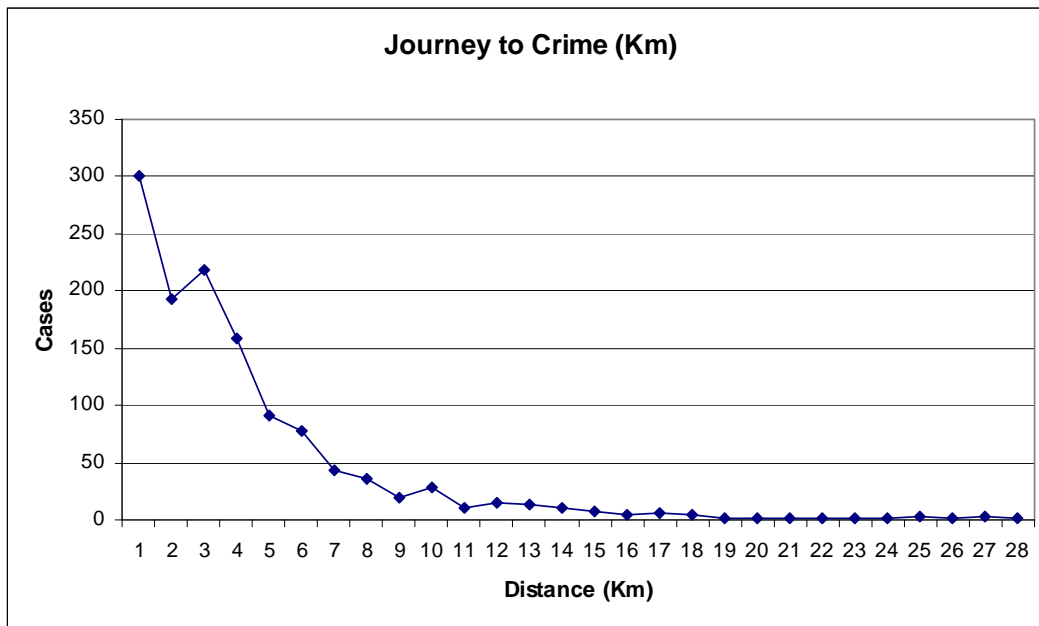
*Figure 8.46: The Maltese Islands Journey-to-Crime Web: the case for Birgu*



Taking the national 1990s journey-to-crime output one further step that tries to analyse the relationship highlighted by Figures 8.49 and 8.50, spatial analysis helped to segregate each distance line generated into individual travel figures.

Figure 8.47 is the result of such an analysis identifying the Journey to Crime likelihood by Distance. It shows the most crime occurs within close proximity to offender residence decreasing with distance. Based on the Spider-Graph tool within MapInfo and the CrimeStat output, a mean journey to crime in the Maltese islands has been given as 3.28km. In fact 32.7% of offenders travel less than 1km, whilst 47.1% travel between 1 and 5km and 13.8% travel between 5 and 10km, with the rest travelling up to 20km, mainly involving inter-island travel.

Figure 8.47: Journey-to-Crime Distance



A council by council analysis (Figure 8.48) shows offenders living in 55 of the 60 crime-registering Maltese councils commit offences within 5km of their residence, whilst the rest vary in distance due to their natural distance from the conurbation, particularly the Northern and Gozitan councils. Further studies could elicit the councils that have highly specific distance figures such as the Gozitan towns that are targeted by Gozitan offenders, cases in point being Nadur, Sannat and Xaghra, the lowest in the matrix.

*Research Question: If offenders commit crimes close to where they live, then does this vary by type of crime?*

One main area of interest would relate to the journeys offenders are prepared to take in order to commit specific offences. A Chi squared test at  $\chi^2$  of 193.553 and  $p = 0.000$  shows a significant relationship between Journey-to-crime and offence by type (Table 8.35). Serious crimes feature high rates of offence within an island perspective (intra-island) as most crimes fall within the 15-

20 km range, however very few fall within the immediate area of residence except for drugs that has a 25% intra-council activity of less than 1Km (Figure 8.49). This is significant in that offenders commit drug offences in their own territory though they do have a wider range to traffic drugs albeit at decreasing rates, with the exception of inter-island trafficking that is composed of another 25% of the group.

*Table 8.35: Crosstabulations and Chi-Square Tests for Journey-to-crime and offence by type*

**offence\_1\_ ' Journey Crosstabulation**

		Journey						Total
		Less than 1 Km	1 to 5 Km	5 to 10 Km	10 to 15 Km	15 to 20 Km	20 Km plus	
offence_1_ 0	Count	3	3	0	0	0	0	6
	% within Journey	.7%	.5%	.0%	.0%	.0%	.0%	.5%
Homicide	Count	11	10	3	0	1	0	25
	% within Journey	2.7%	1.7%	1.7%	.0%	8.3%	.0%	2.0%
Violence against the person	Count	8	3	7	0	0	0	18
	% within Journey	2.0%	.5%	4.1%	.0%	.0%	.0%	1.4%
Serious wounding	Count	17	16	4	4	0	1	42
	% within Journey	4.2%	2.7%	2.3%	7.1%	.0%	8.3%	3.4%
Serious and slight wounding	Count	9	4	5	1	0	0	19
	% within Journey	2.2%	.7%	2.9%	1.8%	.0%	.0%	1.5%
Other violence	Count	25	5	5	1	0	1	37
	% within Journey	6.1%	.8%	2.9%	1.8%	.0%	8.3%	3.0%
Common assault	Count	18	50	8	2	0	0	78
	% within Journey	4.4%	8.5%	4.7%	3.6%	.0%	.0%	6.2%
Sexual offences	Count	22	50	9	5	0	1	87
	% within Journey	5.4%	8.5%	5.2%	8.9%	.0%	8.3%	7.0%
Burglary dwelling	Count	7	12	4	1	1	0	25
	% within Journey	1.7%	2.0%	2.3%	1.8%	8.3%	.0%	2.0%
Burglary other	Count	5	2	1	0	0	0	8
	% within Journey	1.2%	.3%	.6%	.0%	.0%	.0%	.6%
Robbery	Count	16	49	15	9	0	1	90
	% within Journey	3.9%	8.3%	8.7%	16.1%	.0%	8.3%	7.2%
Vehicle crime	Count	32	52	15	2	2	0	103
	% within Journey	7.8%	8.8%	8.7%	3.6%	16.7%	.0%	8.2%
Other theft	Count	66	117	47	16	6	1	253
	% within Journey	16.1%	19.9%	27.3%	28.6%	50.0%	8.3%	20.2%
Theft from Shop, Retail, Leisure and	Count	3	3	0	0	1	0	7
	% within Journey	.7%	.5%	.0%	.0%	8.3%	.0%	.6%
Criminal damage	Count	9	11	1	0	0	0	21
	% within Journey	2.2%	1.9%	.6%	.0%	.0%	.0%	1.7%
Fraud and forgery	Count	7	22	9	0	1	0	39
	% within Journey	1.7%	3.7%	5.2%	.0%	8.3%	.0%	3.1%
Drugs offences	Count	104	72	14	4	0	3	197
	% within Journey	25.4%	12.2%	8.1%	7.1%	.0%	25.0%	15.8%
Other offences	Count	47	107	25	11	0	4	194
	% within Journey	11.5%	18.2%	14.5%	19.6%	.0%	33.3%	15.5%
Attempted offences	Count	0	1	0	0	0	0	1
	% within Journey	.0%	.2%	.0%	.0%	.0%	.0%	.1%
Total	Count	409	589	172	56	12	12	1250
	% within Journey	100.0%	100.0%	100.0%	100.0%	100.0%	100.0%	100.0%

**Chi-Square Tests**

	Value	df	Asymp. Sig. (2-sided)
Pearson Chi-Square	193.553 <sup>a</sup>	90	.000
Likelihood Ratio	194.058	90	.000
Linear-by-Linear Association	.000	1	.999
N of Valid Cases	1250		

a. 71 cells (62.3%) have expected count less than 5. The minimum expected count is .01.

Other serious offences have a relative 5% stake in each of the distance categories, except for robberies which spikes to 15% within the 10-15km range, practically intra-conurbation or intra-island. Such figures need to be spatially analysed in future studies.

Figure 8.48: Journey-to-Crime Distance – Council matrix

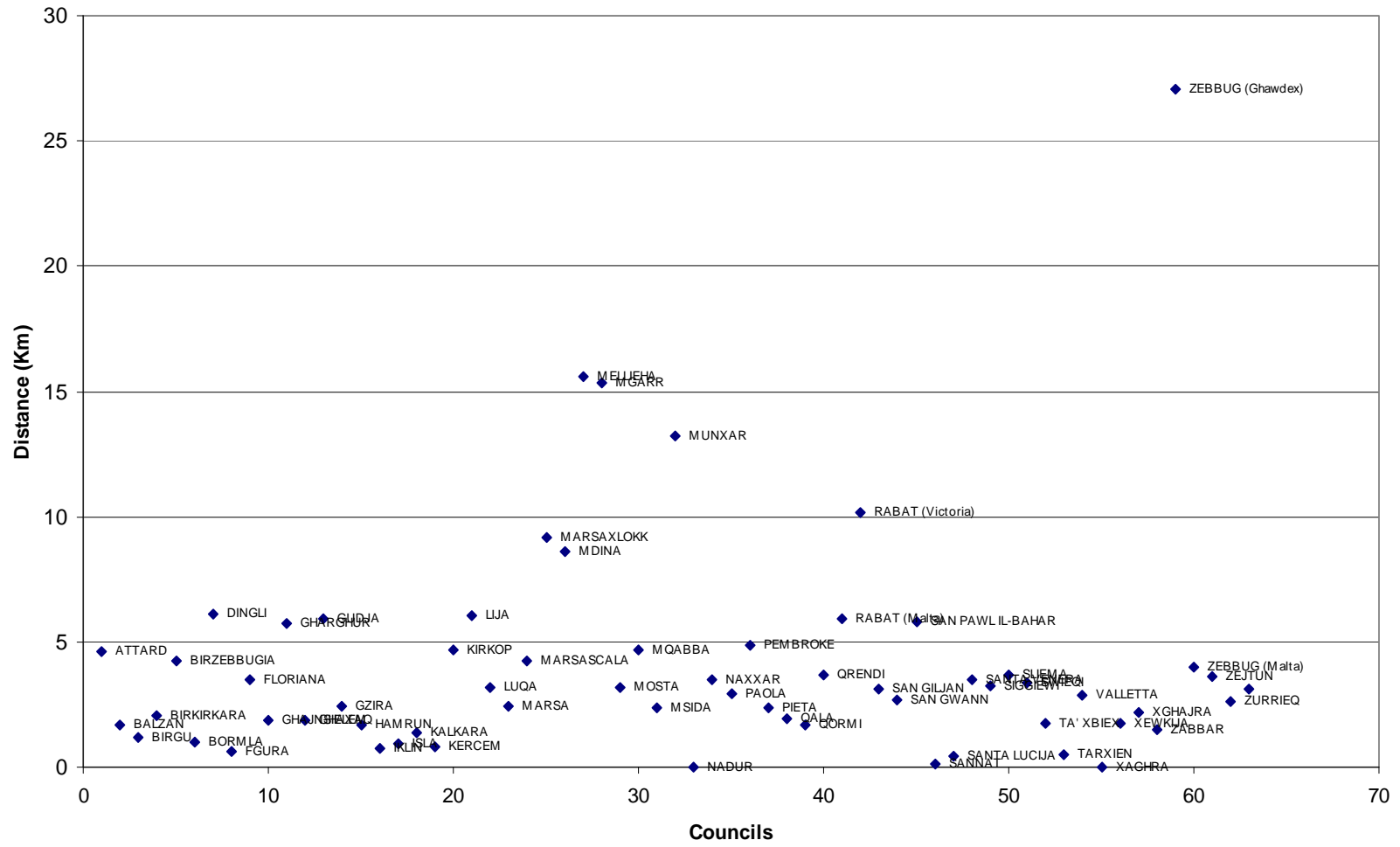
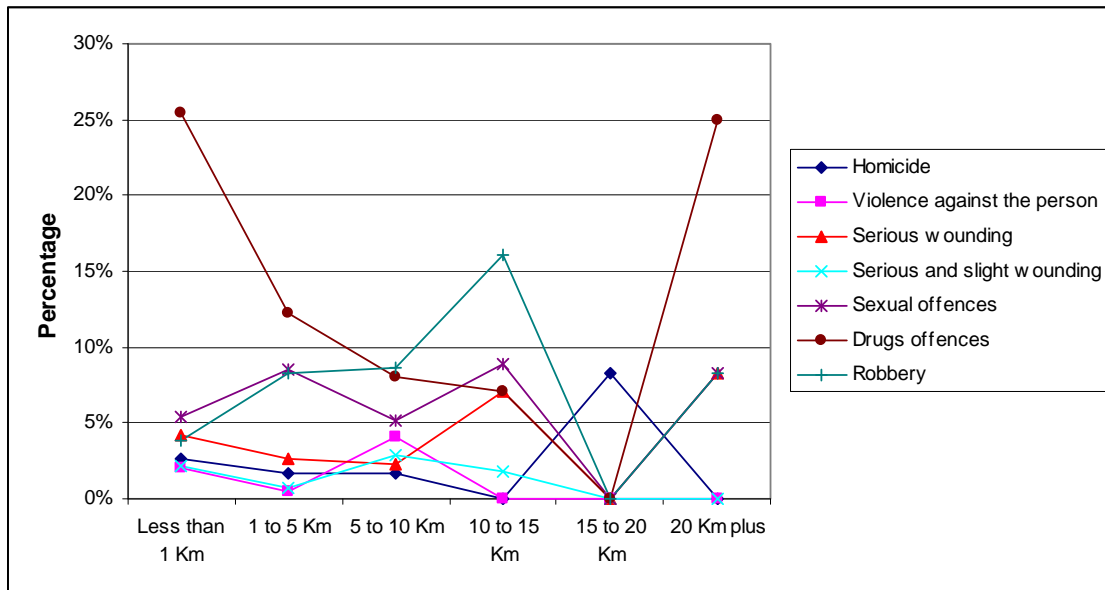
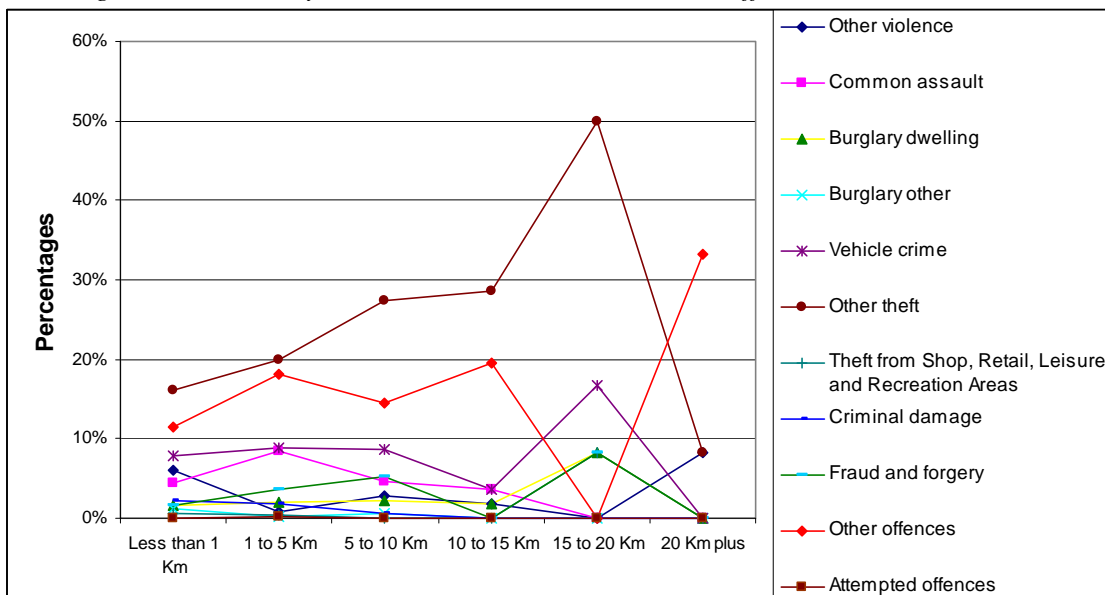


Figure 8.49: Journey-to-Crime Distance – Serious offences



In the case on non-serious offences, all crimes fall within 10% of each distance category, with exceptions for vehicle crime and burglary that spike at the 15-20 Km distance (Figure 8.50). The other main offences, theft and other offence, have a higher than average percentage due to the large number of incidences. The figures do reflect, however, that offenders are ready to travel increasingly longer distances to commit theft within the same island of residence, and at lower levels between the islands.

Figure 8.50: Journey-to-Crime Distance – Non-Serious offences





## **Summary of the Offender-Offence relationships**

In summary, Maltese offenders, though constrained by geographical boundaries (islands) and a very small area to predate in, they still have a very clear modus operandi, in terms of how they operate, where their targets are and which offences are committed where.

Maltese offenders commit crime close to their residence, travel less than 5 Km for most crimes and have a preference for intra-island crime. With a positive relationship between distance and crime type, drug-related crimes are the most popular for crimes committed close to home, whilst theft increases with distance.

## **8.5 Conclusion**

This chapter reviewed three main structures revolving around a number of parameters related to offenders and their social and environmental relationships, their offences and the offender-offence interactivity.

Taking a temporal and spatial perspective, the research identified a number of issues that are unique to the Maltese Islands, amongst these a profile of the local young, increasingly semi-illiterate, unemployed male offender, the changing composition and high rate of foreigners in Maltese prisons, a large amount of recidivism cases, and an increasing participation in serious crime.

Other analysis were based on the location that offenders live in, their migration to the peripheries over the decades, the most concentrated offender-hotspot localities and first clustering analysis of offenders. These results were reviewed against poverty by type of locality and residence, each yielding highly significant outcomes on the relationships. They show a regionalisation based on a harbour/non-harbour grouping, harbour town and UCA/HOS residence location with a move towards the seaside towns.

The offence-related studies show that there is a relationship between crime and dwelling density, population density and vacant dwellings. Also most offences occur within apartments, and buildings in the UCAs. However, they are not strongly related to high-poverty areas.

The offender-offence relationship analysis identified a relationship between crime and distance and the fact that Maltese offenders commit crime close to their residence, generally travelling less than 5 km for most crimes.

With the offenders' background, social relationships and modus operandi covered, the next Chapter looks at the third factor in the CRISOLA construct: landuse. It will employ similar methodologies to analyse offences by landuse type, as well as their characteristics and relationships to the diverse parameters already covered.

## **Chapter 9: Offence Analysis: 1998-2003**

### Introduction

Chapter 9 builds up on the offender-offence analysis in Chapter 8 and investigates the most recent incidence-reports against the landuse construct. The investigation is carried out through an analysis of the spatial construct of reported offences in the Maltese islands. Areas that exhibit high crime concentrations are identified and reviewed in light of their offence category and landuse zoning. The chapter initially reviews whether offences are affected by generic issues as are seasonal and temporal parameters. It then looks at the offence issues as related to landuse-specific zoning such as residential, commercial and recreational areas, which also cover other parameters such as social and community facilities.

This chapter incorporates six years of reported-crime data covering the time period 1998 to 2003, which data was for the first time made digitally-available by the Malta Police Force. The data used for this analysis is derived from the 1998-2003 offences (99,575) reported to the police as geocoded by the author, together with development data and zoning maps as created from landuse-related data.

### **9.1 Temporal Considerations**

This section looks at generic offence issues related to the geographical location of the Maltese Islands, which issues are not strictly related to the social and landuse aspects but may have an effect of the commission of crime. These cover the themes of seasons and time that crimes occur in.

#### 9.1.1 The seasonal parameter

The typical Mediterranean climate registers very short springs and autumns, which are not really meteorological seasons as dictated by the established 3-monthly periods. When attempting to analyse crime in relation to the type of climate Malta experiences, the best way to tackle the seasonal issue is through a review of the tourism seasons (Table 9.1). This is due to the fact that Malta's tourism is based on the summer *festas* and sea-related recreational activities (July to September), with shoulder months before and after this period that can be termed as spring and autumn due to their warm days. Winter, though mild, can be termed to cover the period between November and February.

Table 9.1: Malta's seasons – based on tourism categorisation

Season	Month
Spring	March to June
Summer	July to September
Autumn	October
Winter	November to February

*Research Question: Is there a seasonal effect to crime?*

- **Seasons and Crime Counts**

Based on the seasonal categorisation listed above, summer registers less crime in total than the other months, mainly due to the fact that it has one less month than the shoulder months. However, an analysis of offences by season shows that whilst spring, autumn and winter register an average of 8% of all offences per month, summer registers 10%, particularly the months of July and August at 9,882 and 10,262 offences respectively. This means that over the period 1998 to 2003, the summer months accounted for a relatively larger portion of crimes, which could also be the result of offences on both the Maltese population and the large tourism component present at this time. As data on tourist-related offences is not readily available, such a question poses the need for further study.

A study of seasonal crimes shows that whilst autumn has remained relatively stable on the number of offences, summer had experienced initial decreases and then increases over the last 3 years. In the case of spring and winter, these seasons have shown a steady increase over the years of up to 3% between 1998 and 2003 (Table 9.2).

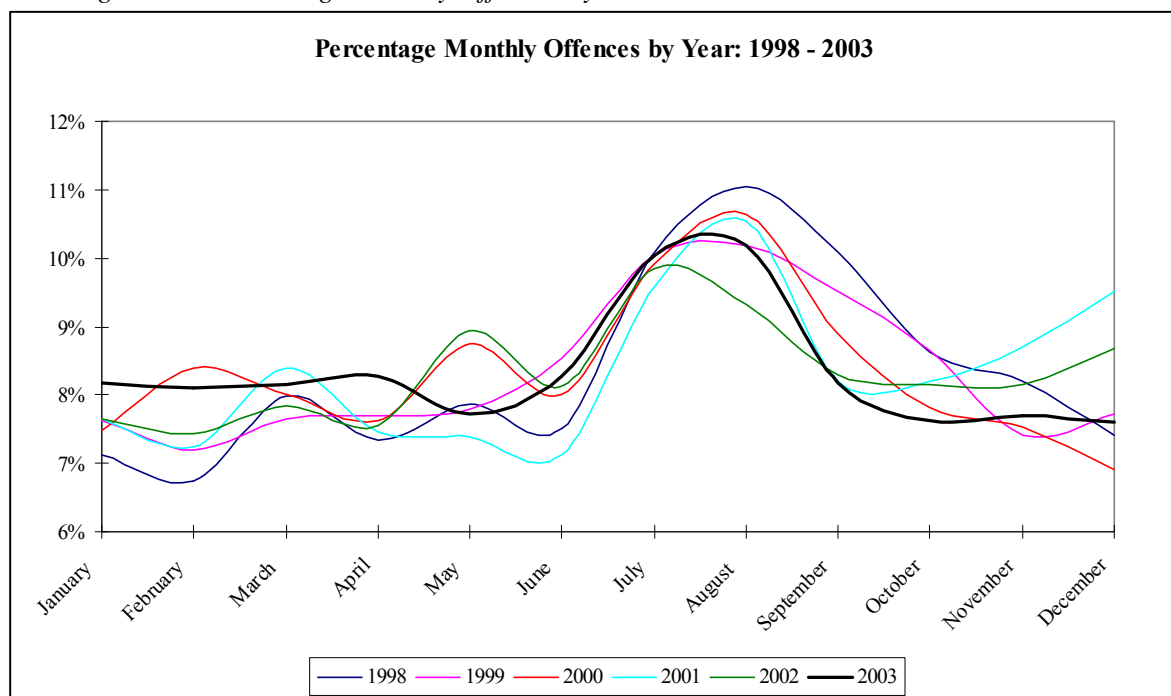
Table 9.2: Seasonal crime: annual changes

Year	Seasons			
	Spring	Summer	Autumn	Winter
1998	15.3%	17.0%	16.7%	15.0%
1999	16.1%	16.5%	17.1%	15.5%
2000	17.5%	17.3%	16.4%	16.7%
2001	15.3%	15.6%	16.0%	17.0%
2002	17.5%	16.2%	17.1%	17.6%
2003	18.3%	17.4%	16.7%	18.1%
<b>Counts</b>	<b>31,564</b>	<b>28,944</b>	<b>8,123</b>	<b>30,944</b>

A deeper monthly analysis over the period 1998 to 2003 shows that there are marked differences even by month within the different seasons. Figure 9.1 show that whilst the summer months spanning from July to September score very high in offences they are declining over the years from an 11% peak in 1998 to 10.3% with a trough in 2002 of 3.3%. The change between the summer to autumn figures show a marked change over time with sharper declines evidenced between August and September when the holiday period is over.

Interestingly the period from October to December has seen an increase since 2001 in monthly offences, which then inverts itself in the winter months and early spring. This is possibly related to an increased winter recreational activities through partying establishments and more favourable climate conditions.

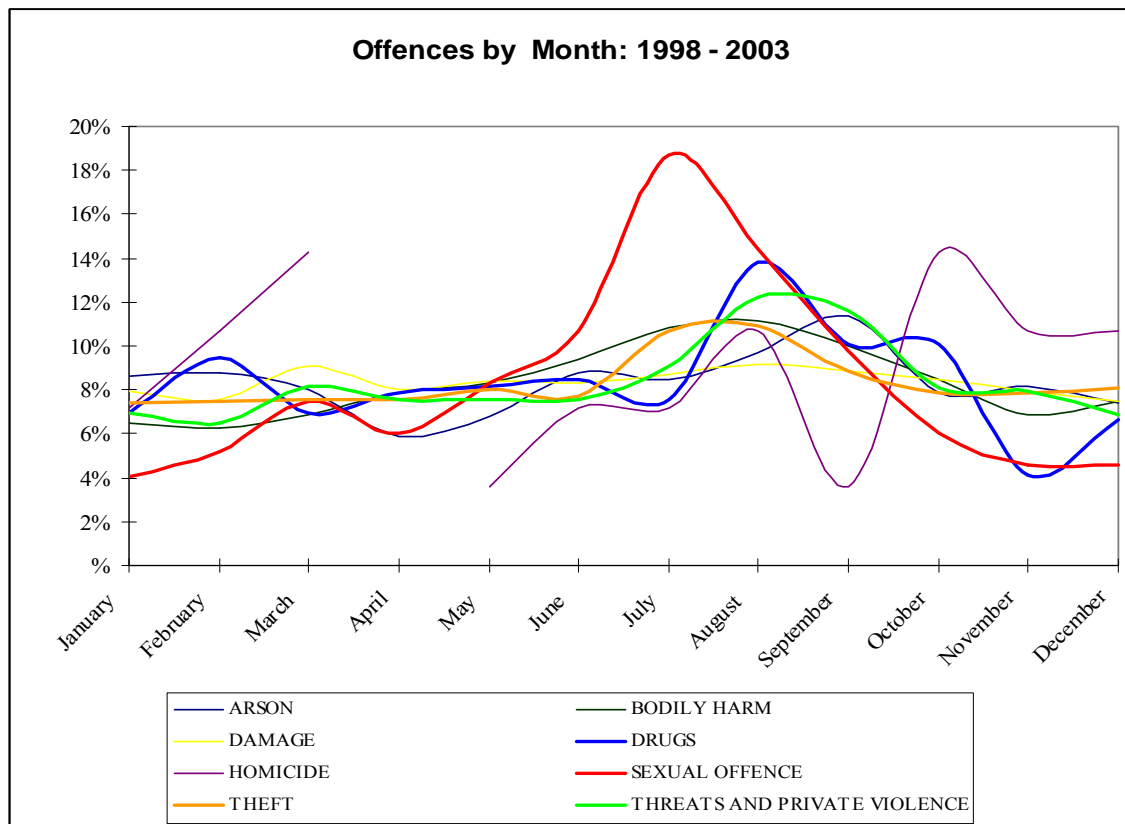
*Figure 9.1: Percentage Monthly Offences by Year: 1998 – 2003*



An analysis of the monthly share for offences by category over the period 1998 to 2003 (Figure 9.2) shows that there are seasonal and even monthly differences for the different crime categories. An analysis of the main crime categories that made up the large part of offences shows that the period July to September peak for a large number of categories particularly sexual offences, drugs, threats and private violence, followed by bodily harm, and thefts. Damages peak slightly but appear to be unrelated to seasonal or monthly issues as the monthly share is quite consistent over the year. Finally, homicides are highly irregular and fluctuate widely.

Interestingly, the shares registering highest in the summer months are either directly related to activities pertaining to summer increases in tourism such as sexual offences primarily reported by students studying English language during holiday-study tours (refer to Table 7.4: Crime Categories). Drugs also increase in summer both due to maturing plant seizures as well as importation of drugs to ‘feed’ the ever-growing party scenes that include international and local party-goers. Threats and bodily harm reach highs in summer due to the high numbers of persons meeting in very small areas such as Paceville and San Pawl il-Bahar, however further study is required, particularly should one delve into other areas of research such as climatological issues as high temperatures, humidity and high pressure systems. These topics need further analysis to establish the relationships between each offence and the eventual targets/victims’ activities.

Figure 9.2: Percentage Monthly Offences by Category: 1998 – 2003



- **Seasons and Crime Categories**

A deeper analysis of the type of offences committed by season may help in the understanding of this phenomenon. A Pearson Chi-Square of 1707.82 and a significance of  $p=0.000$  (Table 9.3) indicates that there is a significant relationship between season and offence. In fact, the data shows that whilst serious crime remains stable throughout the seasons, there is a very clear indication (Figure 9.3) that

winter makes up by far the most offences, particularly in non-serious crimes such as vehicle crime and other thefts, followed by spring and autumn. Interestingly, summer only registers highest in thefts from shops - leisure and recreation areas at double the rate of the other seasons, though vehicle crime, criminal damage and 'other theft' are also very high in summer.

Table 9.3: Crosstabulations and Chi-Square Tests for Seasons and Crime Categories

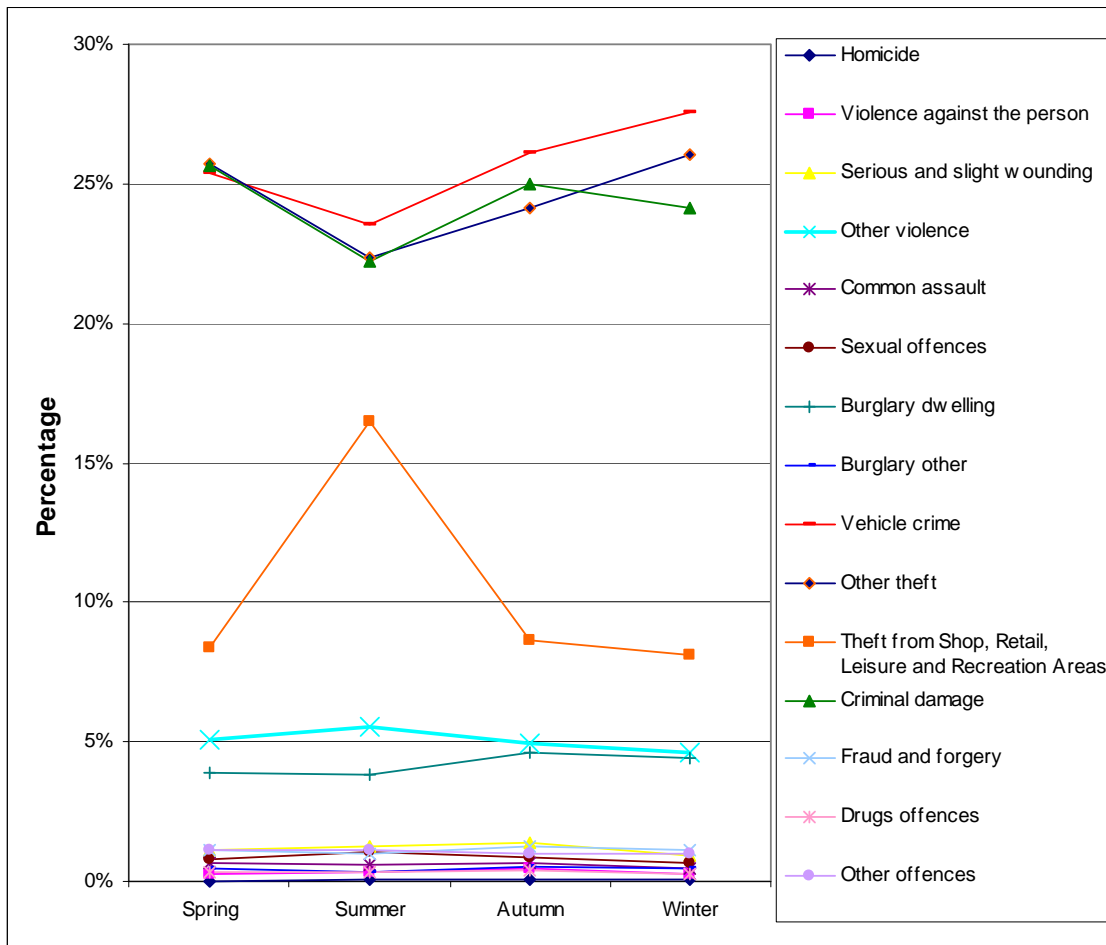
**crime\_cat\_ ^ Seasons Crosstabulation**

			Seasons				Total
			Spring	Summer	Autumn	Winter	
crime_cat_	Homicide	Count	10	13	6	18	47
		% within Seasons	.0%	.0%	.1%	.1%	.0%
	Violence against the person	Count	91	96	35	80	302
		% within Seasons	.3%	.3%	.4%	.3%	.3%
	Serious and slight wounding	Count	355	367	110	279	1111
		% within Seasons	1.1%	1.3%	1.4%	.9%	1.1%
	Other violence	Count	1599	1595	404	1419	5017
		% within Seasons	5.1%	5.5%	5.0%	4.6%	5.0%
	Common assault	Count	207	166	55	152	580
		% within Seasons	.7%	.6%	.7%	.5%	.6%
	Sexual offences	Count	252	305	71	199	827
		% within Seasons	.8%	1.1%	.9%	.6%	.8%
	Burglary dwelling	Count	1238	1108	374	1364	4084
		% within Seasons	3.9%	3.8%	4.6%	4.4%	4.1%
	Burglary other	Count	137	104	41	150	432
		% within Seasons	.4%	.4%	.5%	.5%	.4%
	Vehicle crime	Count	8002	6809	2120	8523	25454
		% within Seasons	25.4%	23.5%	26.1%	27.5%	25.6%
	Other theft	Count	8123	6470	1961	8051	24605
		% within Seasons	25.7%	22.4%	24.1%	26.0%	24.7%
	Theft from Shop, Retail, Leisure and Recreation Areas	Count	2639	4767	701	2509	10616
		% within Seasons	8.4%	16.5%	8.6%	8.1%	10.7%
	Criminal damage	Count	8106	6425	2031	7460	24022
		% within Seasons	25.7%	22.2%	25.0%	24.1%	24.1%
	Fraud and forgery	Count	352	293	102	355	1102
		% within Seasons	1.1%	1.0%	1.3%	1.1%	1.1%
	Drugs offences	Count	100	100	32	86	318
		% within Seasons	.3%	.3%	.4%	.3%	.3%
	Other offences	Count	353	326	80	299	1058
		% within Seasons	1.1%	1.1%	1.0%	1.0%	1.1%
Total		Count	31564	28944	8123	30944	99575
		% within Seasons	100.0%	100.0%	100.0%	100.0%	100.0%

**Chi-Square Tests**

	Value	df	Asymp. Sig. (2-sided)
Pearson Chi-Square	1707.820 <sup>a</sup>	42	.000
Likelihood Ratio	1609.955	42	.000
Linear-by-Linear Association	.985	1	.321
N of Valid Cases	99575		

Figure 9.3: Crimes by season



The Day parameter (weekday-weekend)

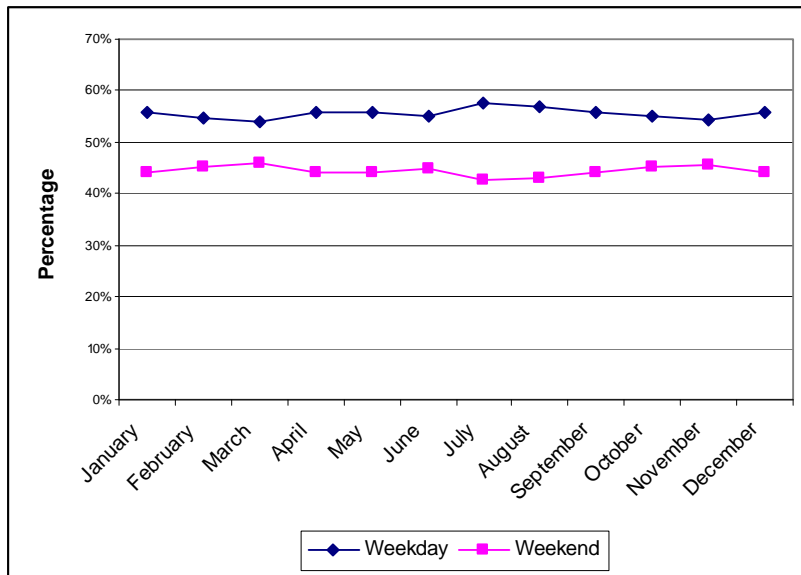
Once seasonal crimes have been covered, two more levels of analysis are explored: the relationship between offences and the day it occurs in as well as the time of occurrence. This issue is important due to the relationship between offences that occur during the weekend and those that occur during the weekday. The main links here relate to recreation: do crimes occur more frequently during the day or night and during the weekday or weekend?

*Research Question: What is the temporal effect on crime – at what time does crime occur most and which categories are most affected*

Considering that the weekday group is composed of four days as against a three day weekend, most crimes occur during the weekday. The data shows that this difference between the weekend and weekday offences is consistent throughout the months (Figure 9.4).

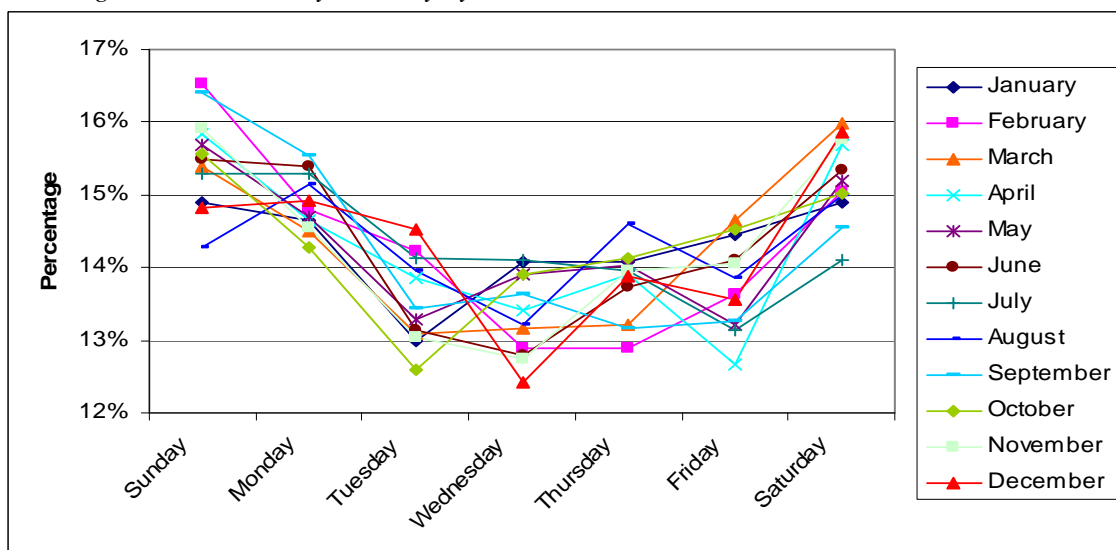


Figure 9.4: Crimes by weekday-weekend



However, on their own merits, the weekend days show a high rate of offences during Friday, Saturday and Sunday (Figure 9.5), throughout the year and particularly during the winter period. This indicates that people tend to become victims during the weekend either through offences at places of entertainment or having their property stolen during the time they are out and the property is empty or unguarded. An analysis of the former shows that violence and wounding incidents are higher during the weekend at 5.6% and 1.2% as against a weekday rate of 4.6% and 1.1%. With respect to property crime, burglary from dwellings has a higher rate during the weekend as against the weekday at 4.4% and 3.9% respectively.

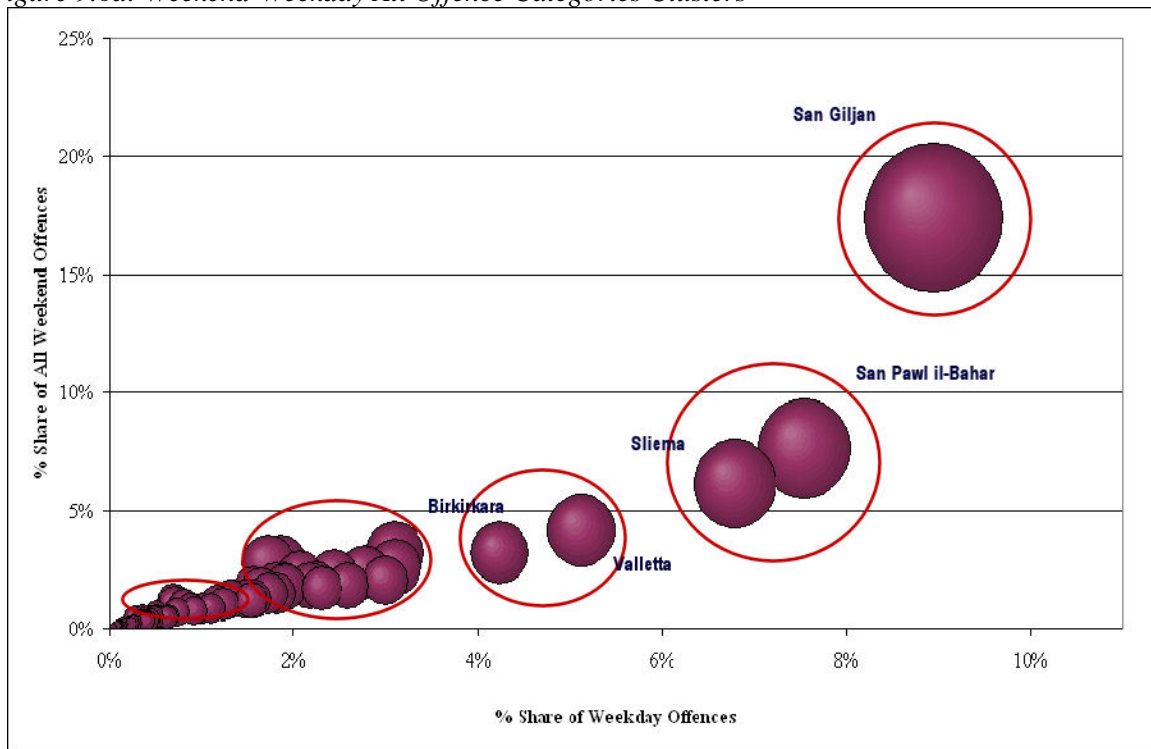
Figure 9.5: Crimes by weekday by month



Reviewing the weekday figures by locality, the study identified that five councils have a significantly higher weekend rate of crime than the weekday rates. The councils in question are San Giljan, San Pawl il-Bahar, Marsascala, Swieqi and Birzebbugia, all of which host some kind of recreational activity. Of these, only San Giljan shows a marked difference between weekday and weeknight crimes, with 6% higher crimes carried out during the weekends than weekdays. The other councils show marginal differences. Such activities give support to Cohen and Felson's (1979) theory that most violations occur through the convergence of likely offenders and their suitable targets, which recreational areas offer.

Figure 9.6a shows the main clusters of localities that experience crimes during weekdays and weekends, which graduations indicate both their position held in the league-table of crime incidences and the relative distance between the main offence-prone localities and the rest of the pack. The figure needs to be read as follows: weekend rates can be read along the Y (vertical) axis and weekday along the X (horizontal) axis, with the spot size representing the relative night-time offence share. As can be easily identified in Figure 9.6a, there are 3 distinct clusters and two other clusters that are difficult to separate.

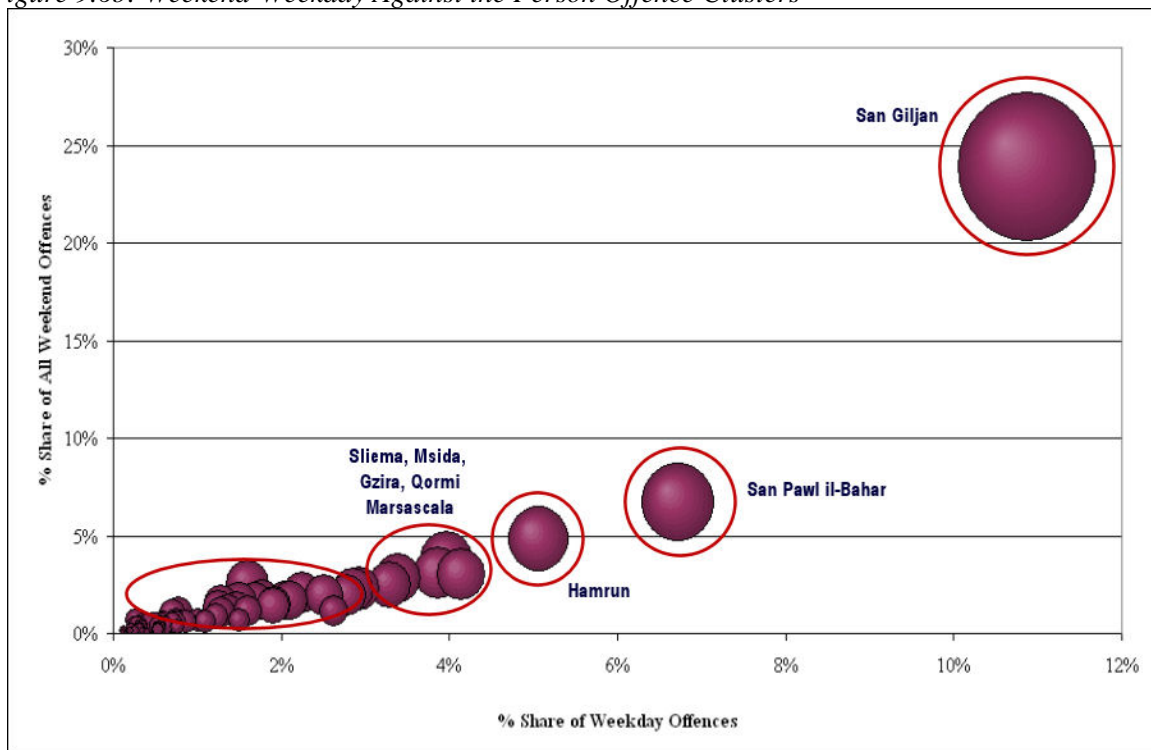
Figure 9.6a: Weekend-Weekday All Offence Categories Clusters



The main and largest single-council cluster, that of San Giljan hosts the highest rates of crime with higher weekend rates (17.4%) than weekday (9.0%). The second cluster, that of San Pawl il-Bahar (7.6% and 7.5%) and Sliema (6.1% and 6.8%) are equally distinct though Sliema experiences an inversion of the weekend dominance over the weekday, which trend is found throughout all the other clusters. Fewer incidences are reported during the weekend in the rest of the towns, mainly due to a relatively smaller number of leisure areas as compared to the concentrated industry in San Giljan. The third main cluster of Valletta and Birkirkara hosts mainly commercial entities. The next clusters can be divided into the retail/seaside areas such as Mellieha, Hamrun, Msida, Qormi, Mosta, Qormi, Gzira, Marsa, Paola, Pieta and Birzebbugia. The final cluster host the least-reporting towns that have relatively small areas inclusive of Gozitan towns, and have a non-recreation/commercial function.

In order to understand better the position of Maltese towns on a weekday verses weekend crime, the analysis was taken a step further and key offences or groups of offences were analysed, where the highest-share clusters were reviewed. The main categories chosen (Tables 9.4b-d) include all ‘crimes against the person’ (assault, violence against the person, wounding, etc), all ‘property crime’ (for example burglary, theft, etc), as well as a specific drugs category. The clusters outlined in each help highlight those areas that are prone to either multiple-offences, specific weekday-weekend variations as well as distance between the clusters indicating offence-share differences.

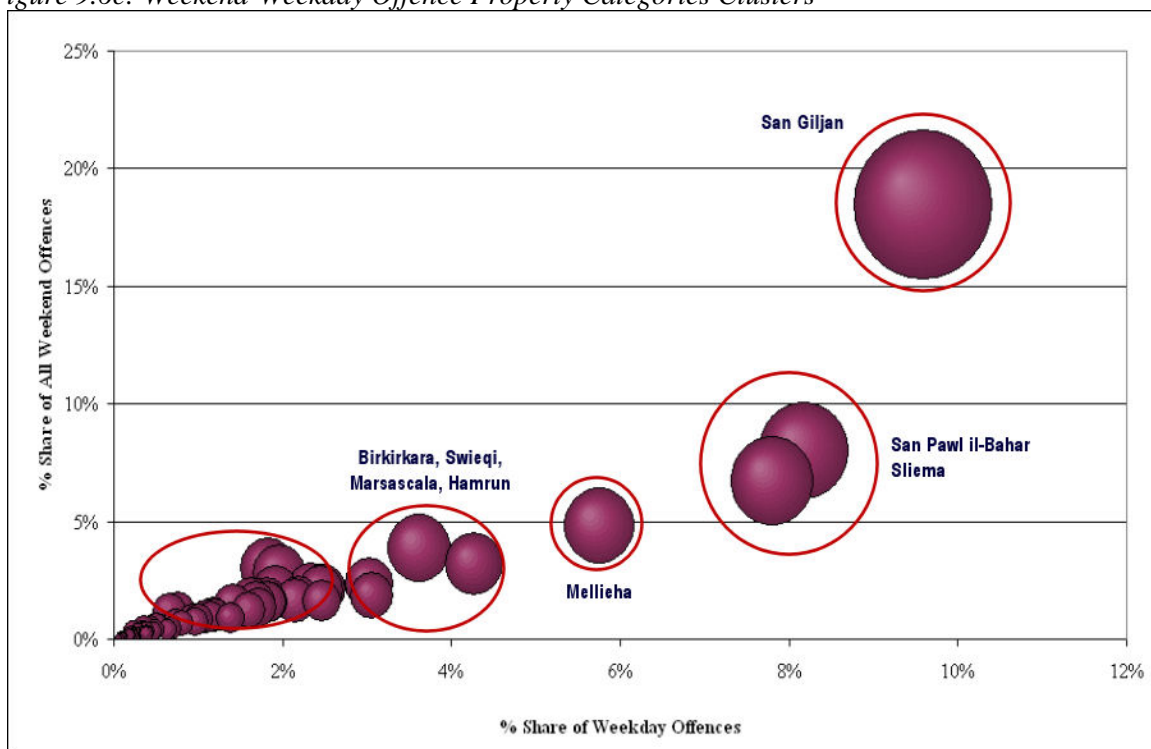
*Figure 9.6b: Weekend-Weekday Against the Person Offence Clusters*



The first analysis (Figure 9.6b) carried out on offences against the person show that whilst most towns have relatively low incidences with less than 4% share each, the first distinct cluster can be found at the 5% mark. Hamrun, has an equal 5% share for both day categories with another single-council cluster of San Pawl il-Bahar at 7%. However the next cluster shows a marked difference for San Giljan between a weekday hit of 11% and a weekend hit of 24%, signifying high rates of violence at any day, but specifically during the weekend, when the area serves as the main recreational venue.

A similar situation is found with respect to Property Crime where San Giljan again registers 10% weekday and 19% weekend share of all councils (Figure 9.4c). Interestingly, there are three other distinct clusters with the next highest composed of San Pawl il-Bahar and Sliema both high density areas composed mainly of apartments (where incidentally the San Pawl il-Bahar is also the council that registers most thefts from residences at 13% on weekdays and 8% on weekends). Mellieha forms a lesser cluster with a slightly higher weekday rating (6% against 5% weekend rate). The other clusters host very small offence share.

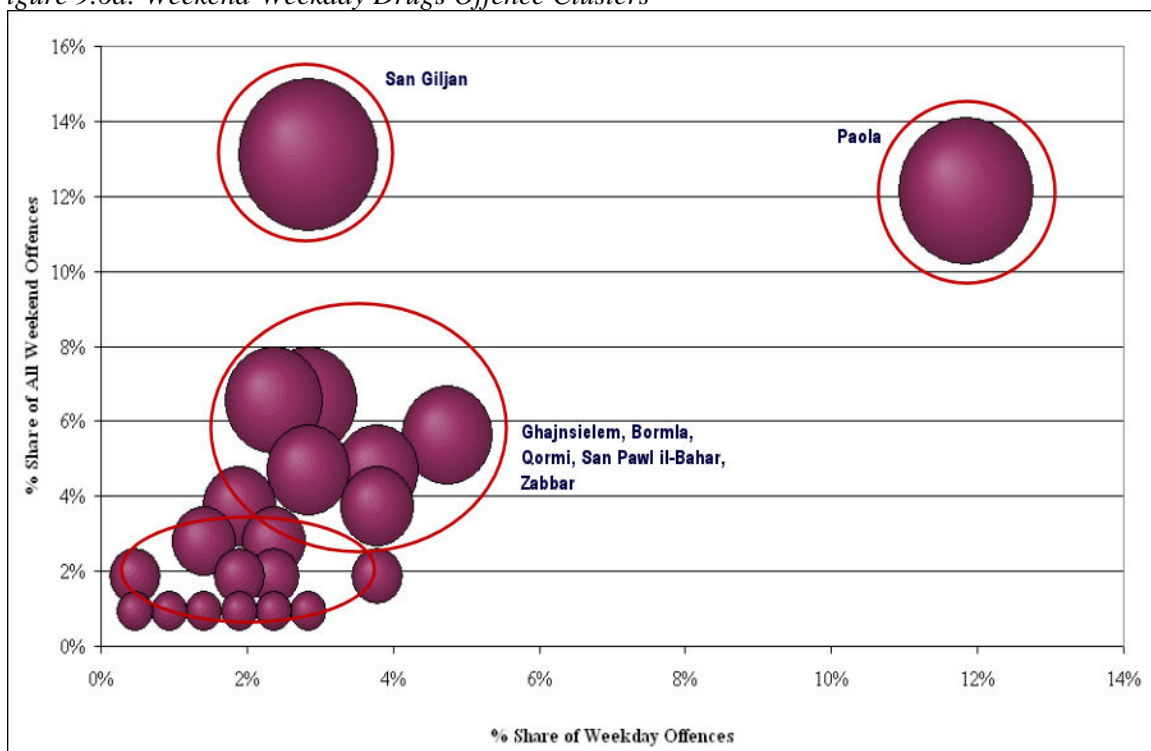
Figure 9.6c: Weekend-Weekday Offence Property Categories Clusters



The final cluster analysis concerned the category drug offences (Figure 9.4d). Interestingly, San Giljan exhibits very specific weekend-weekday distinctions where from a relatively small 3% weekday share this shoots up to 13% during the weekend directly linking drug taking to the weekend

leisure and recreational activities occurring in the locality. This is in contrast to another area Paola that registers 12% share during both periods, indicating a situation that is linked more to cohesion than recreational activities since Paola hosts a town centre that serves a social role rather than entertainment activities. More studies are needed on this area particularly the roles of cultivating, trafficking and use. The next distinct cluster is composed of the Gozitan harbour town of Ghajnsielem, San Pawl il-Bahar, Bormla and Zabbar. Whilst all exhibit higher weekend incidences, the localities have different functions, with the former two having recreational and leisure activities whilst the others are predominantly residential. Note that in the case of drugs, such figures could indicate a stronger police presence too.

Figure 9.6d: Weekend-Weekday Drugs Offence Clusters



In summary, there are some areas such as San Giljan and to a lesser extent San Pawl il-Bahar that show marked differences from the other towns in their offence share composition and weekend-weekday activities. San Giljan is highlighted as the highest-recording town but exhibits a clear weekend-weekday distinction for most activities.

The above analysis gave both a general and detail analysis of the main seasonal, monthly and daily parameters of offences, which results point to the need for further detailed study to understand the dynamics of offending in Malta, particularly those related to time, spatial context and changes in the

spatio-temporal aspects as analysed over the next sections. Different spatial constructs such as old cities, seaside towns, and recreational areas are investigated.

### 9.1.2 The Time parameter

Having identified weekdays as the highest crime rate periods, except for a few recreation-related localities, the next step aims to analyse offences by time. This analysis indicates that most serious crimes per hour occur at night between 20:00 and 03:00 as against non-serious offences (such as criminal damage and theft) which are stable throughout the day and night, though they peak between 05:00 and 10:00. These figures indicate that whilst those serious crimes that are reported usually register their reports immediately as they occur (as happens in such cases and physical violence at night), non-serious crimes may only be reported either when the offence is first seen or when people wake up and find their house burgled or vehicle stolen, to cite two examples. This said, one must keep in mind the issue of dark-figure where crimes are not reported as described in the introductory section of Chapter 7, which includes both serious and non-serious offences.

An offence review (Figure 9.7a&b) shows that most vehicle crime is reported at around 06:00 with secondary reporting around 16:00 on closure of office work. Similarly, theft from shops and recreational centres follow this trend particularly during the afternoon opening hours 16:00-19:00 and during the night period from 23:00 to 04:00, recurring mostly in the recreational areas.

Figure 9.7a: Crimes by Time: highest ranking

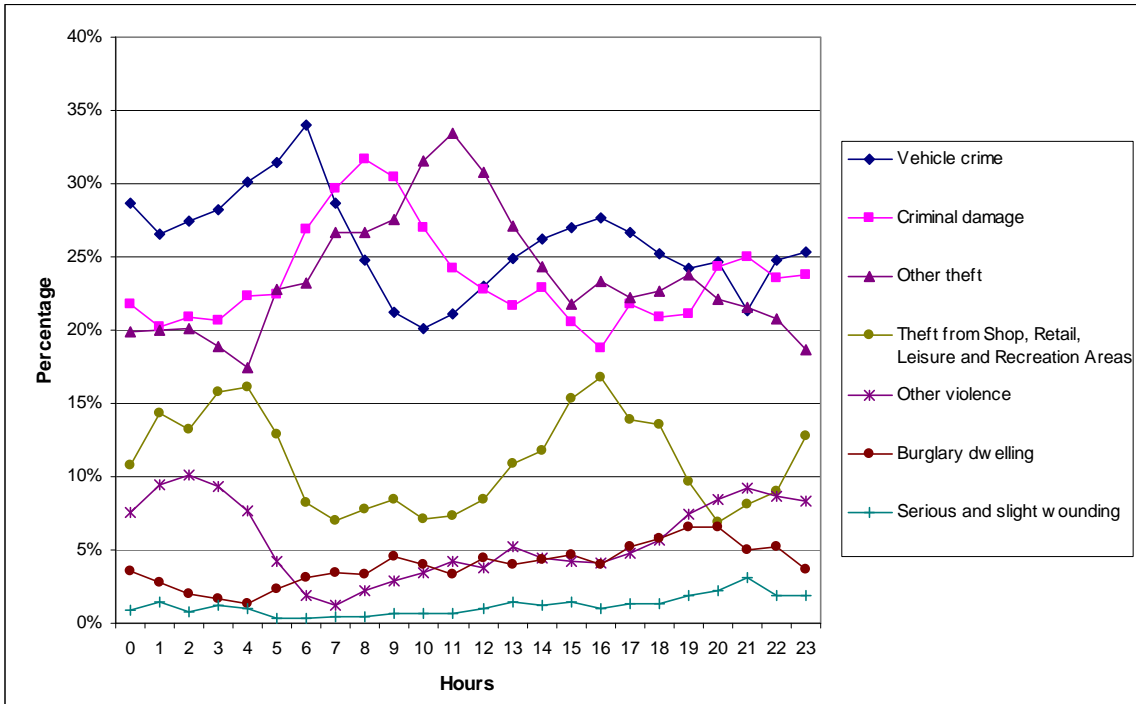
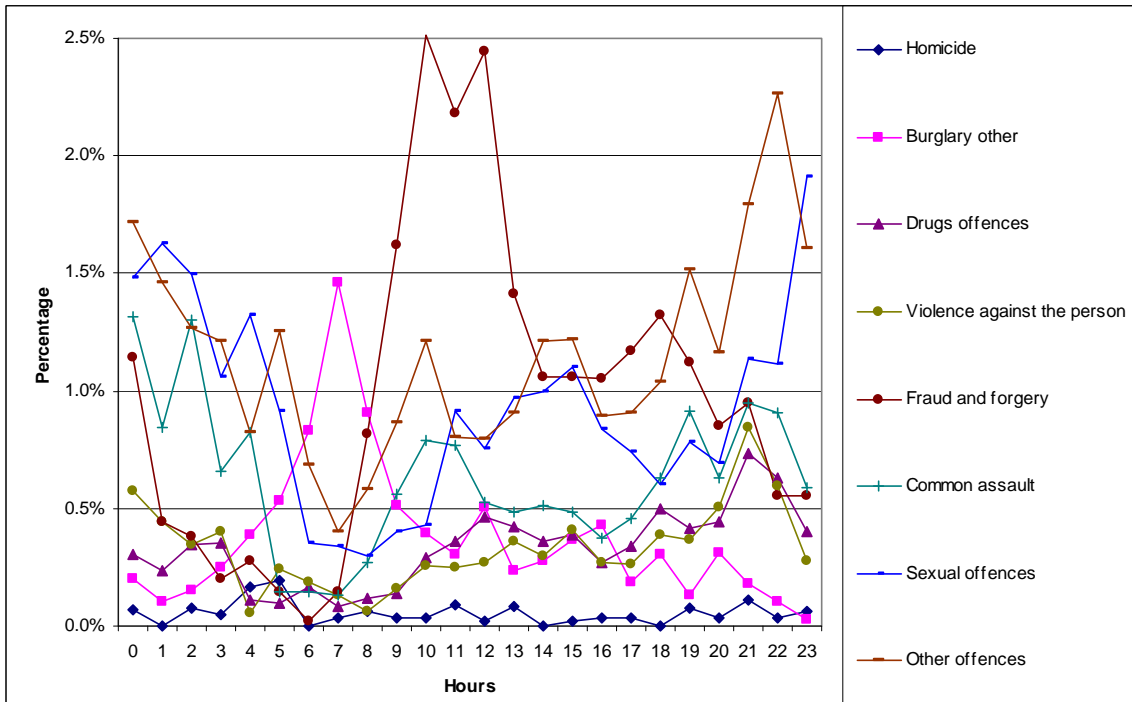


Figure 9.7b: Crimes by Time: lowest ranking



The best way to substantiate this day-night difference result can be carried out through an analysis of day and night K-means clustering. This test looks at a day (06:00 to 19:59) versus night (20:00 to

06:00) period and identifies those areas that fall within each cluster, which study might help identify the types of areas hosting such crimes.

Table 9.4 and Figure 9.8a depicts a daytime clustering output that highlights the highest (most-concentrated) location as the Valletta and Northern Harbour region, followed by the San Giljan (San Giljan) area. The areas of the Three Cities and the Southwest form another cluster. These areas, whilst attracting crime, are not high in the league table as those are locations zoned for commercial and mainly recreational activity, which locations are analysed in detail further in this topic. The day clustering shows that the airport area in Gudja and the surrounding villages comprise a specific cluster, that could be due to the number of offences reported within the airport itself and the retail incorporated there as well as in the industrial areas to the south of this area.

Table 9.4: K-Means clustering by day-night periods

Cluster	Location (Day)	Offences	Cluster	Location (Night)	Offences
1	San Giljan Area	15,202	1	San Giljan Area	7,914
2	Three Cities and South West	10,612	2	Northern	3,213
3	Western	12,035	3	Western	2,203
4	Valletta and Northern Harbour	19,588	4	Southern	3,729
5	Northern	12,066	5	Western Harbour	3,093
6	Airport Area	6,834	6	Valletta and Northern Harbour	3,086

Figure 9.8a: Day K-Means clustering

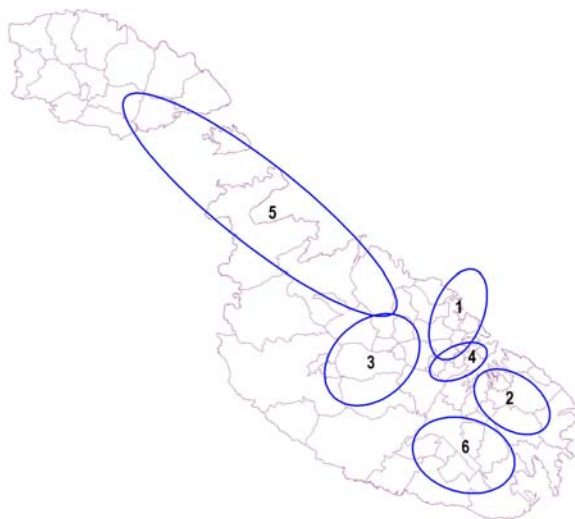
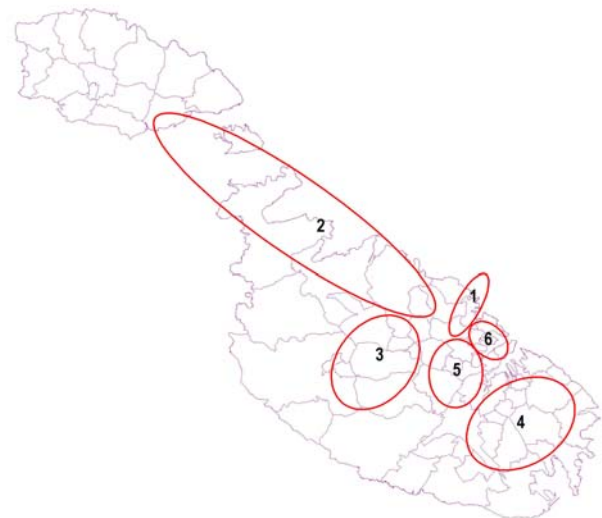


Figure 9.8b: Night K-Means clustering



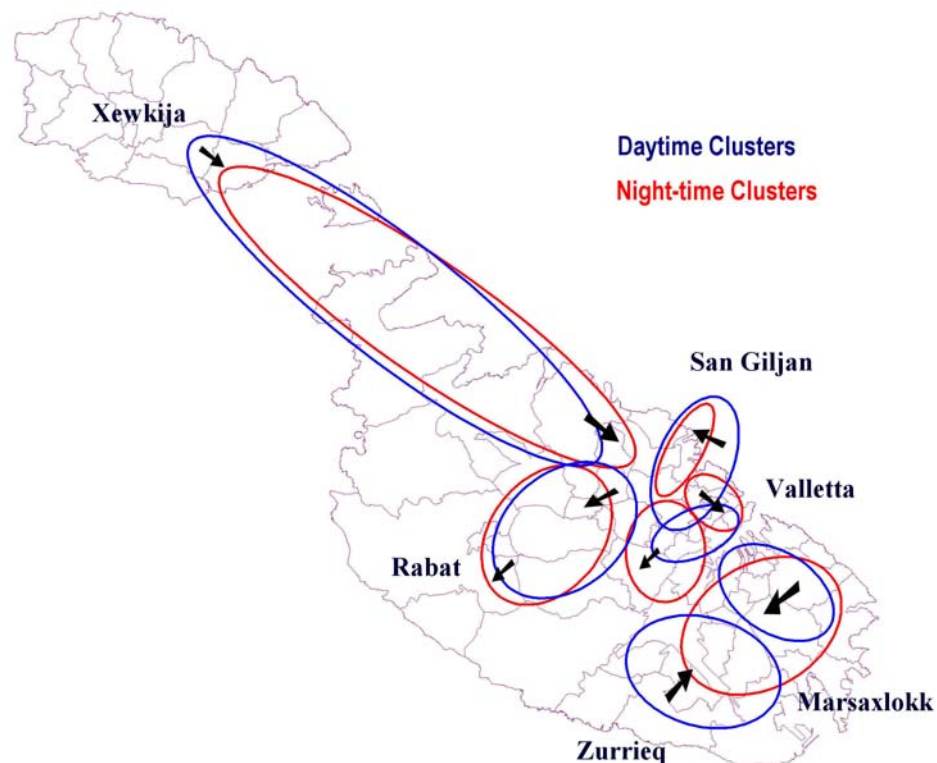
Night-time clustering (Figure 9.8b) whilst smaller in incidence counts, shows a similar pattern to the daytime period with the exception of some changes in structure such as the integration of the airport



and old cities areas as well as changes in the Northern Harbour structures. In terms of the most concentrated hotspot, San Giljan tops the list, which is indicative of its activity nature by night.

A comparative analysis, as shown in Figure 9.9 indicates that the main day-night cluster movements occur through a phenomenon of compaction where the main day clusters either grow smaller such as in the San Giljan area where the main hotspot is concentrated over the small sub-locality of Paceville and the adjacent Swieqi area, both used for transport and recreational night-time activities. Another area of interest concerns the splitting up of the daytime Northern Harbour area into the Western Harbour and a smaller Northern Harbour area. Such a splitting is counteracted by the integration of two hotspots in the south that indicates that the airport-related area offences move towards the main conurbation area in the south, through closure of both airport and industrial activities.

*Figure 9.9: K-Means clustering by day-night periods – comparative analysis*



A review of the main categories analysed in the weekend-weekday analysis shows that the property category takes up the larger share of offences (Table 9.5a), peaking between 04:00 and 07:59 and diminishing slowly up to 23:59. Most of the night time share is taken by San Giljan at 40% for the 00:00 to 03:59 period and the 20:00 to 23:59 period at 19%. The situation changes during the day where Valletta (10%), Sliema (10% and 11%) peak during the next 3 periods. This signifies that

most property offences such as theft from cars occur during high commercial activity since the two towns host major retail town centres (Table 9.5b).

The offences against the person category shows the inverse to this phenomenon since it is lowest between 04:00 and 07:59 and increases steadily up to 20:00 and 23:59 then it decreases slightly up to 04:00 (Table 9.5c). The latter night periods host 35.6% of crimes during that 8 hour period with San Giljan taking the largest share of all location and period shares at 44% between 00:00 to 03:59, followed by 16% in the next period and 14% in the 20:00 to 23:59 period. San Pawl il-Bahar and Hamrun register the highest daytime periods at 6% each for every 4-hour block.

Interestingly drug uptake increases throughout the period from 04:00 (7% share) to 19:59 with the latter period having 22.3% share then starts decreasing during the night. The main issue here is that most drug taking during the day occurs from 08:00 till 19:59 where Paola takes top spot reaching 15%, 18% and 16% share in the three 4-hour time periods under study (Table 9.5d). Once night sets in, other areas take precedence in drug-related activities, namely San Giljan with 12%, 24% and 9% during the 3 night periods, whilst San Pawl il-Bahar peaks at 14% from 04:00 to 17:59. This reversal adds weight to the discussion in Figure 9.6d that the two areas are distinct in their activities where the Paola area drug activities are linked with 'daily life issues such as cultivating, trafficking and use', whilst San Giljan and San Pawl il-Bahar drug taking is related to recreation drugs. One does not exclude here that the same persons could also be apprehended in both area types.

### 9.1.3 Summary

In summary, Malta, experiences high summer rates of crime by month, though the winter months register the most crimes in total as well as being the most favourite for non-serious crimes as against a serious crime situation that is not dependent on seasons. Winter also experiences the greatest differences between weekend as against weekday offences, with the recreational localities being the primary targets. This situation is reinforced by an location study of offences that occur during weekend-weekends as well as though an hourly analysis that shows that most night offences occur in these areas, comprised of 'violence against the person' and property-related offences. Daytime offences fluctuate according to the specific commercial activity in an area or due to social factors such as daytime-drug activities. These findings confirm Wikstrom's (1990) assertion that that inner-urban activities fluctuate over time and space and that there are different activities experienced at different times of the day, in turn resulting in different types of offences being committed.

Table 9.5a: Offence categories share by time periods

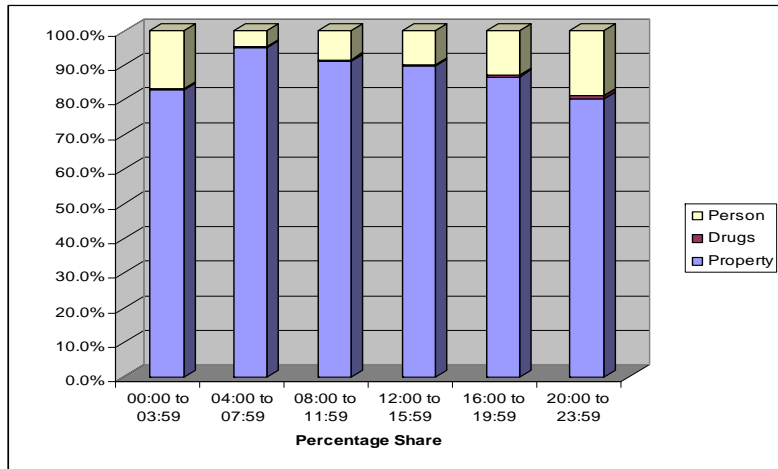


Table 9.5b: Property offences' share by time periods: Highest Localities

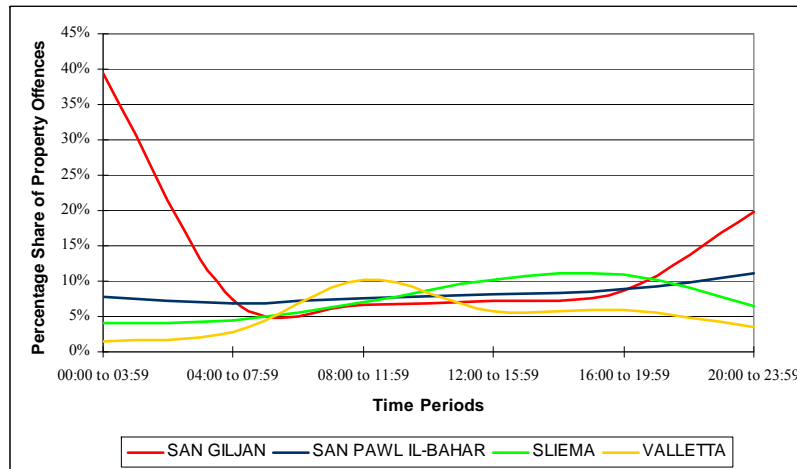


Table 9.5c: Person offences' share by time periods: Highest Localities

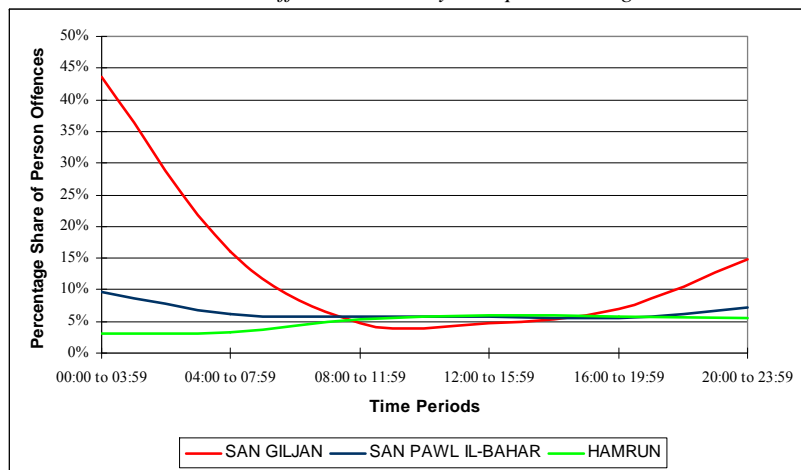
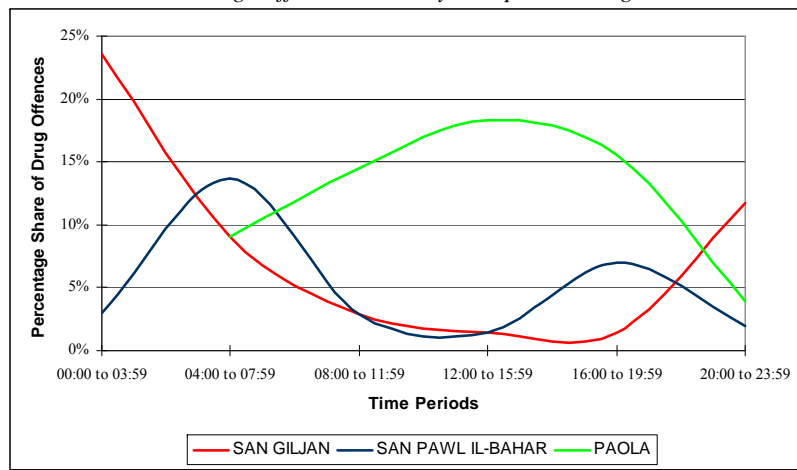


Table 9.5d: Drugs Offences' share by time periods: Highest Localities



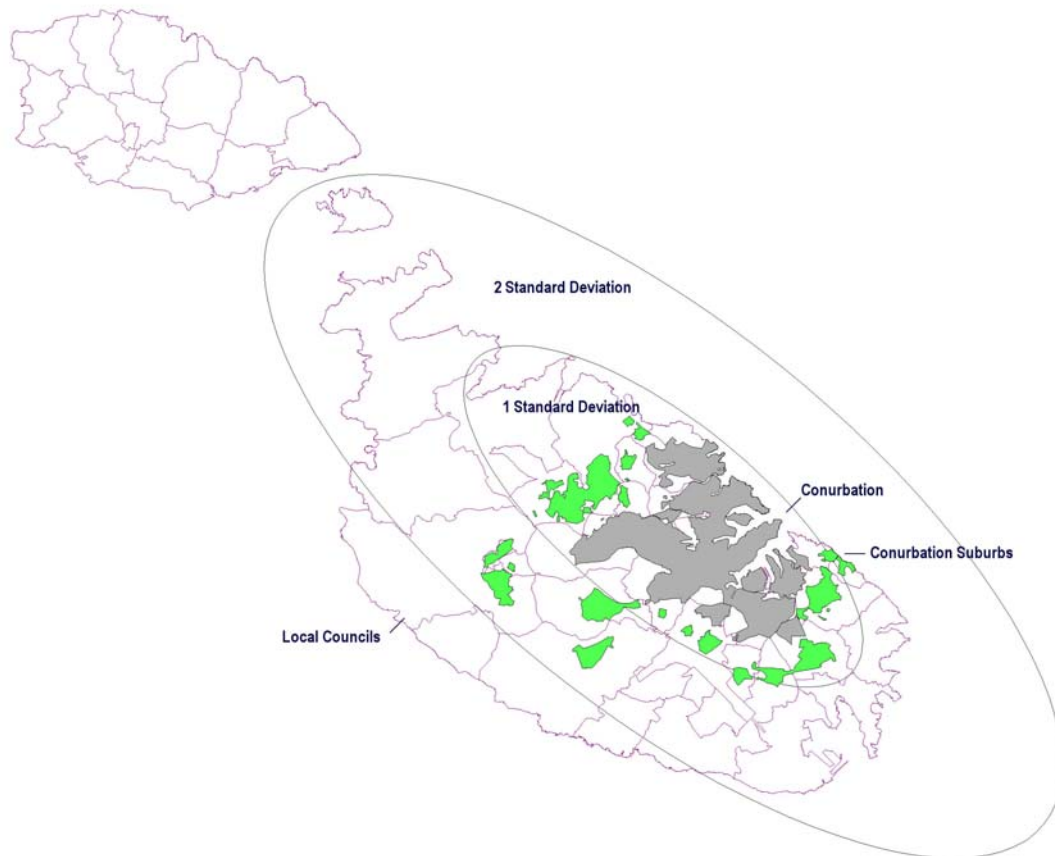
## 9.2 Spatial Level Considerations

Having identified when offences occur, the next section attempts to understand where offences occur and if there is any relationship between offences and the locations they occur in, an issue indicated in the previous section's temporal analysis. This section strives to understand which areas are prone of host offences.

*Research Question: Are there distinctive regional level variations in crime?*

In the process of analysing whether there is a locational construct to crime, spatial statistics were employed. As in the case of offender-residence analysis carried out in chapter 8 (Figure 8.17), a Standard Deviational Ellipse (SDe) was carried out at 1 and 2 Standard Deviations. This hotspot exercise is based on all (1998-2003) reported crimes and was carried out through CrimeStat employing its Standard Deviational Ellipse (SDe) methodology (Figure 9.10).

*Figure 9.10: Offence Standard Deviational Ellipse (SDe) at 1NNH and 2NNH*



Running a SDe test, at 1StDev and 2StDev results show that most offences are concentrated in Malta, whereas the island of Gozo hosts relatively few offences. This exercise once again highlights the fact that 68% of all crimes (1StDev) fall mainly within the conurbation, however in difference to the offender residence, where the main concentration lived within the Grand Harbour area (N-S ellipse), the offence ellipse exhibits a NW-SE orientation. This immediately indicates that the main bulk of offences fall within the northern shore localities of Malta and encompasses also the northern seaside town of San Pawl il-Bahar. This result backs the discussion on offences in this locality, which incidences are significantly large enough to cause an elongation of the ellipse.

### 9.2.1 Offences by Locality

Running a test on offences by locality, the result shows that most offences in the Maltese Islands occur in a relatively small number of localities. Such a claim is reinforced both by a Chi Squared test at  $\chi^2$  of 1411.56 and a p = 0.000 (Table 9.6) show that most offences in the Maltese Islands occur in a relatively small number of localities. This test as well as by the finding that 50% of crime are concentrated in 10 localities, all within the conurbation, except for Mellieha and San Pawl il-Bahar (Table 9.7). At the other extreme, 10 Gozitan localities fall within the 12 least offence-reporting localities in the Islands.

*Table 9.6: Chi-Square Tests for Number of Offences by Locality*

<b>Chi-Square Tests</b>			
	Value	df	Asymp. Sig. (2-sided)
Pearson Chi-Square	1411.555 <sup>a</sup>	350	.000
Likelihood Ratio	1388.022	350	.000
N of Valid Cases	99575		

*Research Question: Is crime in any one area disproportionately concentrated compared with that area's share of the total population?*

Detailed analysis of offence changes over the 1998 and 2003 period shows that like Table 8.16 which identified that a few councils host most of the offenders, in the case of offences, the top four councils host 32% of total reported offences (Table 9.7). These councils host leisure and recreation areas and have a low concentration of population as compared to the total population.

Table 9.7: Percentage Offences and Population by Locality sorted by 1998-2003 data and change 2002-2003: NUTS 5

	Offences % 1998	Offences % 1999	Offences % 2000	Offences % 2001	Offences % 2002	Offences % 2003	Offences % Change 02-03	Population % 1998	Population % 1999	Population % 2000	Population % 2001	Population % 2002	Population % 2003	Population Change 02-03
San Giljan	10.61	11.29	12.64	11.81	11.04	11.75	Increasing	1.88	1.87	1.88	1.88	1.89	1.89	Increasing
San Pawl il-Bahar	7.34	7.60	7.40	8.53	7.33	7.21	Decreasing	1.92	1.95	1.98	2.03	2.06	2.11	Increasing
Sliema	6.45	6.36	6.62	6.25	6.83	6.93	Increasing	3.25	3.22	3.18	3.17	3.15	3.13	Decreasing
Valletta	4.25	4.84	3.97	4.24	5.31	6.14	Increasing	1.88	1.86	1.84	1.83	1.81	1.79	Decreasing
Birkirkara	3.73	4.17	3.79	3.95	4.49	3.45	Decreasing	5.64	5.64	5.64	5.63	5.63	5.62	Decreasing
Hamrun	3.34	2.89	2.61	2.75	3.14	2.95	Decreasing	2.91	2.89	2.88	2.86	2.83	2.81	Decreasing
Qormi	2.46	2.72	2.72	2.53	2.46	2.89	Increasing	4.72	4.71	4.70	4.69	4.69	4.66	Decreasing
Mellieha	3.16	3.20	4.08	2.94	2.73	2.71	Decreasing	1.61	1.61	1.62	1.63	1.65	1.66	Increasing
Msida	2.64	2.67	2.63	2.81	3.00	2.45	Decreasing	1.83	1.82	1.82	1.81	1.81	1.80	Decreasing
Gzira	2.45	2.31	2.03	2.81	2.34	2.41	Increasing	2.04	2.03	2.03	2.03	2.01	2.01	Decreasing
Paola	1.92	2.14	2.19	2.08	2.05	2.35	Increasing	2.47	2.46	2.45	2.42	2.40	2.39	Decreasing
Mosta	2.38	2.37	2.20	2.44	2.39	2.28	Decreasing	4.50	4.52	4.53	4.53	4.52	4.53	Increasing
San Gwann	1.71	1.84	1.79	1.99	1.61	2.21	Increasing	3.18	3.20	3.20	3.21	3.21	3.22	Increasing
Marsa	2.22	2.12	2.11	2.06	2.08	2.16	Increasing	1.39	1.38	1.37	1.36	1.35	1.34	Decreasing
Birzebbugia	2.76	1.94	2.23	1.58	1.95	2.11	Increasing	1.96	1.97	1.98	1.99	2.00	2.00	Increasing
Marsascala	2.43	2.33	1.80	2.30	1.97	2.03	Increasing	1.31	1.33	1.36	1.41	1.45	1.49	Increasing
Zabbar	1.35	1.65	1.59	1.53	1.64	2.03	Increasing	3.81	3.81	3.81	3.81	3.80	3.80	Increasing
Gudja	1.46	1.45	1.79	2.09	2.01	1.97	Decreasing	0.77	0.77	0.77	0.77	0.77	0.77	Decreasing
Pieta	2.18	2.63	2.03	1.77	1.85	1.95	Increasing	1.12	1.11	1.11	1.10	1.10	1.09	Decreasing
Naxxar	1.71	1.74	1.94	2.07	1.88	1.91	Increasing	2.63	2.64	2.65	2.67	2.68	2.70	Increasing
Attard	1.40	1.31	1.93	1.60	1.86	1.76	Decreasing	2.45	2.46	2.45	2.46	2.46	2.46	Decreasing
Swieqi	2.09	2.01	2.67	2.22	1.49	1.74	Increasing	1.68	1.69	1.69	1.70	1.71	1.72	Increasing
Zejtun	1.74	1.41	1.02	1.45	1.60	1.58	Decreasing	3.02	3.01	3.01	2.99	2.98	2.97	Decreasing
Rabat (Malta)	1.93	1.38	1.41	1.40	1.94	1.57	Decreasing	3.04	3.02	3.00	2.98	2.97	2.95	Decreasing
Fgura	1.08	1.41	1.43	1.62	1.48	1.52	Increasing	2.97	2.99	2.99	2.99	3.00	3.00	Increasing
Zebbug (Malta)	1.16	1.27	1.56	1.45	1.59	1.34	Decreasing	2.80	2.80	2.81	2.81	2.81	2.82	Increasing
Floriana	1.62	2.15	1.98	1.77	1.46	1.33	Decreasing	0.70	0.69	0.68	0.67	0.66	0.66	Decreasing
Santa Venera	1.43	1.10	1.03	1.12	1.14	1.22	Increasing	1.64	1.64	1.64	1.64	1.64	1.63	Decreasing
Bormla	1.44	1.46	1.27	1.26	1.17	1.13	Decreasing	1.61	1.60	1.59	1.58	1.58	1.57	Decreasing
Tarxien	0.78	0.63	1.07	0.82	0.89	0.96	Increasing	1.99	1.99	1.98	1.99	1.99	1.99	Increasing
Siggiewi	1.24	1.25	1.09	1.18	1.16	0.93	Decreasing	1.92	1.93	1.93	1.93	1.93	1.93	Increasing
Luqa	1.12	0.92	1.02	1.20	1.01	0.89	Decreasing	1.54	1.49	1.46	1.42	1.39	1.36	Decreasing
Zurrieq	1.14	1.00	1.03	0.85	0.93	0.87	Decreasing	2.33	2.33	2.34	2.34	2.34	2.34	Increasing
Pembroke	0.75	0.80	0.85	0.87	0.81	0.79	Decreasing	0.63	0.64	0.65	0.66	0.67	0.68	Increasing
Rabat (Victoria)	0.96	0.74	0.67	1.04	1.02	0.74	Decreasing	1.73	1.72	1.72	1.72	1.71	1.71	Decreasing

Table 9.7: Percentage Offences and Population by Locality sorted by 1998-2003 data and change 2002-2003: NUTS 5

	Offences % 1998	Offences % 1999	Offences % 2000	Offences % 2001	Offences % 2002	Offences % 2003	Offences % Change 02-03	Population % 1998	Population % 1999	Population % 2000	Population % 2001	Population % 2002	Population % 2003	Population Change 02-03
Ta' Xbiex	0.90	0.98	0.91	0.85	0.92	0.71	Decreasing	0.45	0.45	0.44	0.45	0.44	0.44	Increasing
Balzan	0.75	0.66	0.65	0.72	0.77	0.70	Decreasing	0.91	0.90	0.90	0.91	0.90	0.90	Decreasing
Marsaxlokk	1.14	0.77	0.78	0.84	0.80	0.65	Decreasing	0.76	0.77	0.77	0.77	0.77	0.77	Increasing
Ghajnsielem	0.32	0.47	0.42	0.54	0.58	0.51	Decreasing	0.58	0.59	0.61	0.62	0.62	0.63	Increasing
Ghaxaq	0.46	0.36	0.38	0.31	0.39	0.51	Increasing	1.11	1.11	1.11	1.12	1.12	1.12	Increasing
Mgarr	0.81	0.56	0.43	0.33	0.59	0.50	Decreasing	0.72	0.72	0.72	0.73	0.73	0.74	Increasing
Kalkara	0.74	0.82	0.58	0.45	0.54	0.50	Decreasing	0.76	0.76	0.76	0.76	0.76	0.76	Decreasing
Isla	0.62	0.65	0.47	0.45	0.38	0.50	Increasing	0.93	0.93	0.92	0.92	0.91	0.90	Decreasing
Birgu	0.68	0.63	0.50	0.48	0.67	0.48	Decreasing	0.80	0.79	0.79	0.78	0.78	0.78	Decreasing
Santa Lucija	0.48	0.25	0.41	0.32	0.29	0.46	Increasing	0.97	0.97	0.96	0.96	0.96	0.96	Decreasing
Zebbug (Ghawdex)	0.43	0.44	0.46	0.35	0.43	0.45	Increasing	0.39	0.39	0.40	0.40	0.41	0.41	Increasing
Kirkop	0.50	0.38	0.33	0.36	0.36	0.44	Increasing	0.53	0.53	0.54	0.54	0.54	0.54	Increasing
Xaghra	0.41	0.43	0.26	0.33	0.29	0.39	Increasing	0.97	0.97	0.97	0.97	0.98	0.98	Increasing
Iklin	0.34	0.30	0.35	0.28	0.37	0.39	Increasing	0.84	0.84	0.85	0.85	0.85	0.85	Increasing
Mdina	0.34	0.37	0.46	0.41	0.52	0.37	Decreasing	0.10	0.10	0.10	0.10	0.10	0.10	Increasing
Qrendi	0.66	0.55	0.49	0.52	0.49	0.34	Decreasing	0.63	0.63	0.63	0.63	0.63	0.63	Decreasing
Dingli	0.37	0.54	0.53	0.38	0.47	0.33	Decreasing	0.74	0.75	0.75	0.75	0.75	0.76	Increasing
Lija	0.34	0.38	0.49	0.40	0.39	0.32	Decreasing	0.65	0.65	0.66	0.65	0.65	0.65	Decreasing
Munxar	0.37	0.44	0.30	0.28	0.29	0.30	Increasing	0.21	0.21	0.21	0.21	0.21	0.22	Increasing
Safi	0.25	0.26	0.15	0.25	0.18	0.30	Increasing	0.47	0.47	0.47	0.47	0.47	0.47	Increasing
Mqabba	0.36	0.29	0.21	0.29	0.17	0.28	Increasing	0.71	0.72	0.72	0.72	0.72	0.73	Increasing
Nadur	0.44	0.37	0.33	0.41	0.37	0.26	Decreasing	1.03	1.03	1.03	1.05	1.07	1.08	Increasing
Mtarfa	0.21	0.24	0.31	0.21	0.21	0.26	Increasing	0.38	0.39	0.39	0.40	0.40	0.41	Increasing
Gharghur	0.20	0.22	0.20	0.21	0.18	0.25	Increasing	0.53	0.53	0.53	0.54	0.54	0.55	Increasing
Xewkija	0.25	0.28	0.30	0.37	0.39	0.24	Decreasing	0.84	0.84	0.84	0.84	0.84	0.84	Decreasing
Gharb	0.15	0.11	0.08	0.09	0.13	0.15	Increasing	0.26	0.26	0.26	0.27	0.27	0.27	Increasing
Kercem	0.09	0.14	0.09	0.13	0.15	0.13	Decreasing	0.42	0.42	0.42	0.42	0.42	0.41	Decreasing
San Lawrenz	0.09	0.11	0.08	0.16	0.06	0.13	Increasing	0.14	0.14	0.14	0.14	0.14	0.14	Increasing
Xghajra	0.19	0.28	0.19	0.26	0.24	0.12	Decreasing	0.19	0.20	0.20	0.20	0.21	0.21	Increasing
Qala	0.13	0.21	0.18	0.13	0.12	0.12	Increasing	0.40	0.40	0.40	0.40	0.41	0.41	Increasing
Sannat	0.16	0.14	0.17	0.10	0.15	0.10	Decreasing	0.43	0.43	0.43	0.44	0.44	0.44	Increasing
Fontana	0.06	0.04	0.03	0.06	0.09	0.06	Decreasing	0.22	0.22	0.22	0.22	0.22	0.22	Increasing
Ghasri	0.12	0.09	0.09	0.14	0.08	0.05	Decreasing	0.10	0.10	0.10	0.10	0.10	0.10	Decreasing
Total	15,771	16,046	17,030	15,912	17,043	17,773								

Note: changes marked as increasing or decreasing when figures are the same, this points to the 3rd decimal change

Table 8.16 had also identified that the localities with an increasing offender concentration also had a shrinking population concentration over a decadal period. In the case of offences analysed in this section which reviews annual change in the last two years of 2002-2003, there is no clear direction that one can readily compare. The top two councils show a very slight increase in population but only San Giljan shows an increase in offences (following a two-year decline) whereas San Pawl il-Bahar registered a decline over the last two years. Others follow the same pattern such as Sliema and Valletta which show increasing crime and decreasing population. Valletta again makes the top for the wrong reasons, having already experienced an increasing offender concentration with a decreasing population. It is important at this stage to note that offences need not only be compared to population since that may not be the main factor since offences are not caused by residents but also by others such as the weekend visitors to San Giljan. Other parameters that help avoid a fallacy should concentrate on visitor numbers, cars parking in the area, retail units and other variables.

This main finding in this section shows that the top areas suffering the highest changes in offences either host high concentrations of recreational and commercial/retail centre areas and or host multiple issues of concerns such as increasing concentrations of offenders. Again, these issues need to be further researched to identify how the causes and effects can be mitigated inclusive of security, depopulation, and multiple-issue problems such as identified in Valletta.

### 9.2.2 Offences by District

Locality analysis is best analysed at a more abstract NUTS level: District level NUTS 4 (Figure 9.11). This level identifies the Northern Harbour district as the highest offence-registering area in the Maltese Islands, which area hosts the main commercial and recreational areas. At an average above 7,000 offences per year (42% of total), this district hosts twice as much as the next highest district (Southern Harbour) at less than an average of 3,500 (21%). In fact the two regions together comprise 63% of all offences. As indicated in the locality analysis, the least registering district is Gozo at 4%). Figure 9.12 shows a map of the percentage offences in each district, with the main highlight being the Northern Harbour district.



Figure 9.11: District offences by region

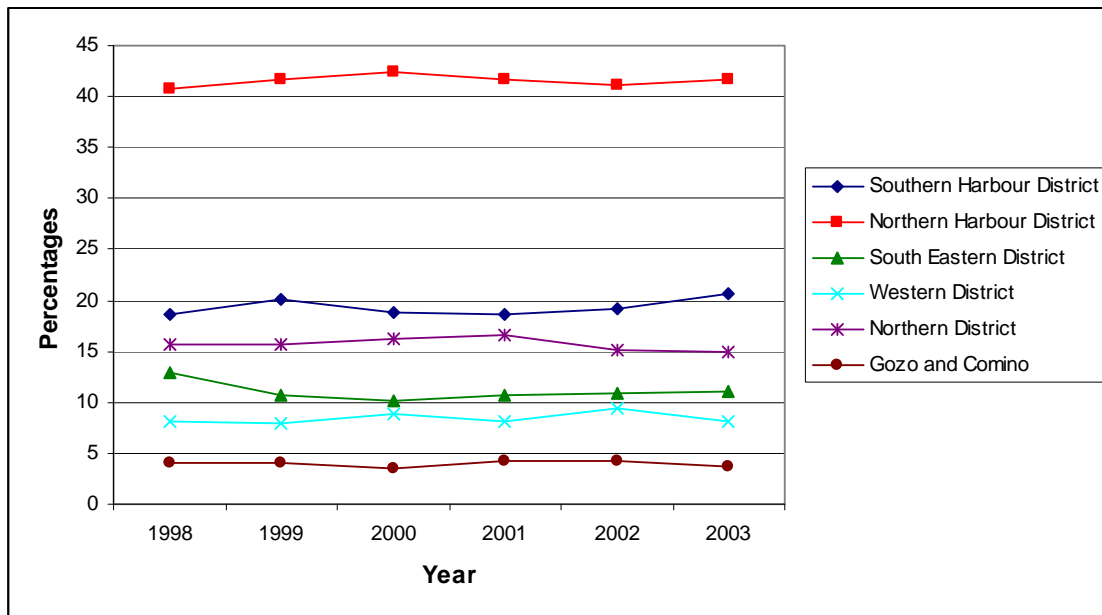
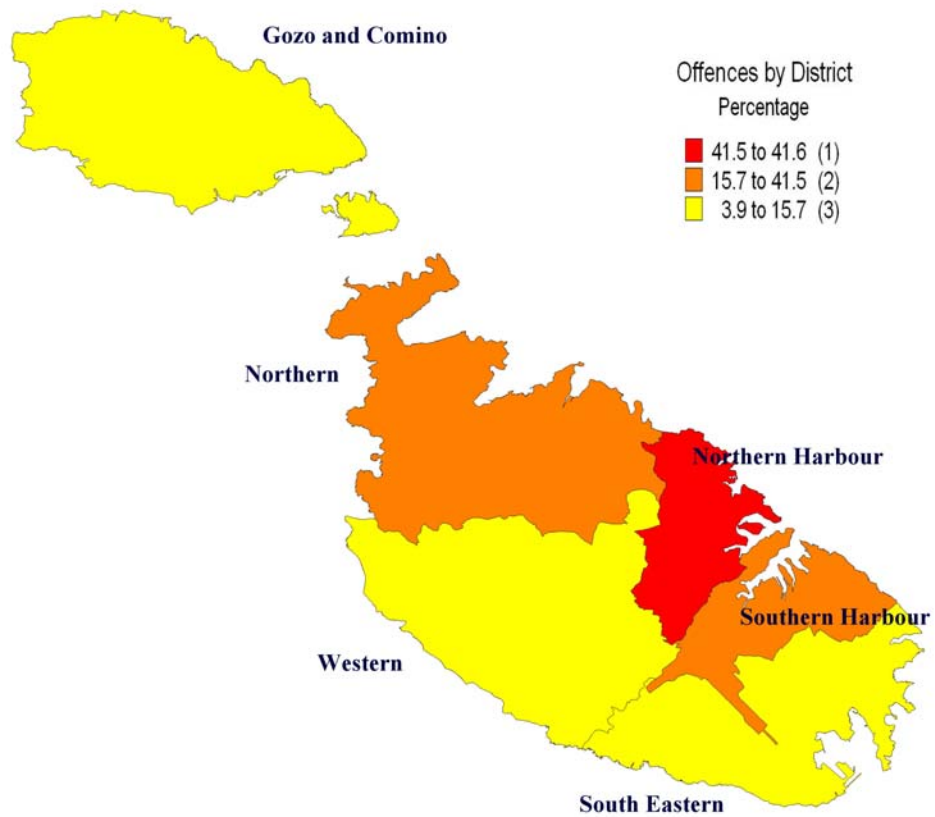


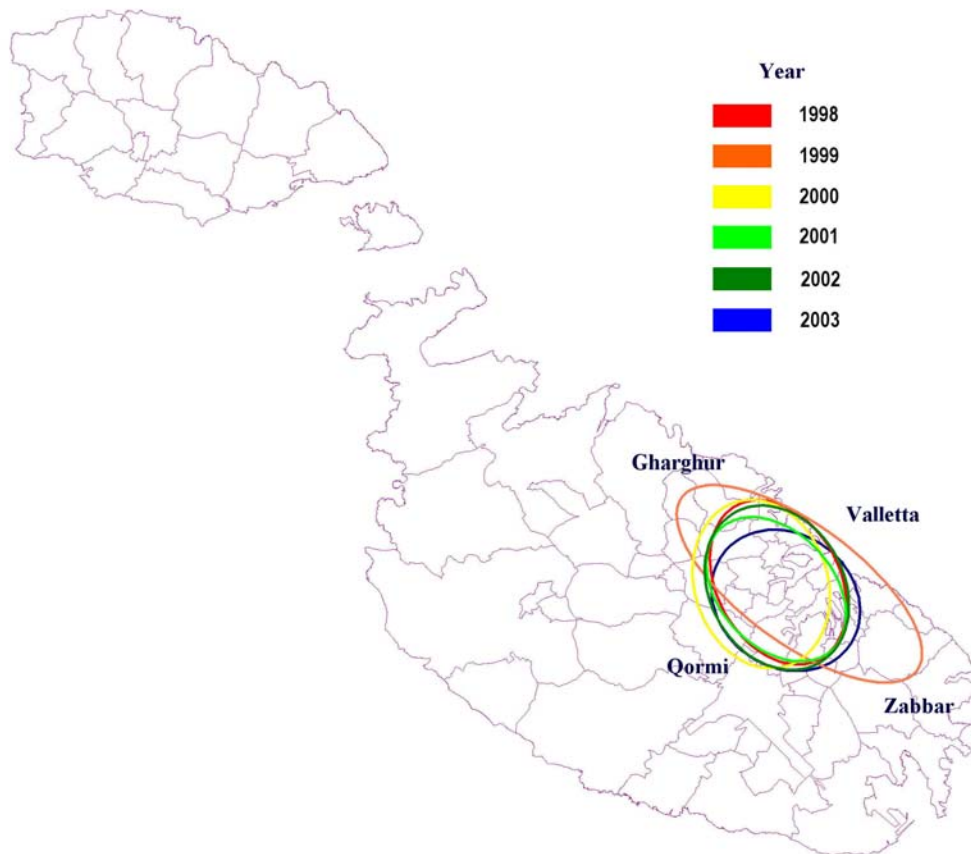
Figure 9.12: District offences by region: map



### 9.2.3 Point Analysis: a spatial approach

To better understand offence changes at this level, it would be best to look into offences through their xy coordinates as against a pre-defined spatial boundary. This required the use of spatial clustering methodology as employed in Chapter 8. Each annual offence data output was overlaid over the previous year's, which process resulted in the identification of movements of offence hotspots, allowing for comparative analysis at 2NNH and 3NNH<sup>161</sup>. 1NNH was not employed for this exercise due to the large number of offence entities that resulted in very small hotspots, which are not easy to review<sup>162</sup>. The colours represent a different year as per legend. Figure 9.13 depicts the 3NNH hotspots for the years 1998 to 2003. The results cover the areas depicted by the K-means output as well as the Standard Deviational ellipse described above, with a concentration in the Northern Harbour region.

*Figure 9.13: 3NNH (Spatial Clustering) inter-year change analysis 1998-2003 - at 25 points minimum per hotspot*



<sup>161</sup> 3NNH comprised 99.7% of all cases.

<sup>162</sup> This is the result of the large number (99,575) points under study, which generate many hotspots due to the consistent usage of a 25 points minimum per hotspot.

Each inter-year change was analysed for its movements and how offences changed over time and space. In difference to the offender inter-decadal analysis, an annual change analysis is more volatile and can result in very large changes over the years that compact or expand ellipses in quick succession over the years.

The 3NNH 1998-1999 (Figure 9.14a) analysis shows that there was an expansion of the 1998 offence ellipse along the NW-SE axis towards the towns of Gharghur in the North and Zabbar in the South. This was the result of increases in offences in the Northern and Southern Harbour regions. This change was negated over the next year (1999-2000) with a compaction to the 1998 ellipse position, indicating that the 1999 ellipse was some form of anomaly as it is not replicated in the other years. Such a compaction was the result of a reduction of offences in the Southern Harbour and South-Eastern regions (Figure 9.14b).

The 2000-2001 saw a slightly compacted move towards the Southern Harbour indicating an increase in the South-Eastern region with a reduction in the Southern Harbour and Western regions. Increases in the Northern and Gozo regions were too slight to effect the global inter-year change for this period (Figure 9.14c).

The next period (2001-2002) saw a move towards the Southern Harbour and Western regions, mainly due to slight increases in these regions corresponded by a decrease in the Northern region (Figure 9.14d). Due to the increasing number of offences, the result shows that expansion occurs for a number of changes in the different regions, not just through one regional change. This situation is further enhanced through an analysis of the 2002-2003 change (Figure 9.14e), which resulted in more compacted movement towards the Southern Harbour region, with a corresponding reduction in the Western region.

This hotspot analysis shows that over the six-year period there was a gradual migration of offences towards the Southern Harbour region with crime reduction in the Northern region and fluctuating changes in the Western region. However, the Northern Harbour region remains strong, mainly due to the high offence rates in San Giljan, Sliema, Birkirkara, Hamrun and Qormi.

Figure 9.14a-e: 3NNH (Spatial Clustering) inter-annual change analysis 1998-2003 - at 25 points minimum per hotspot

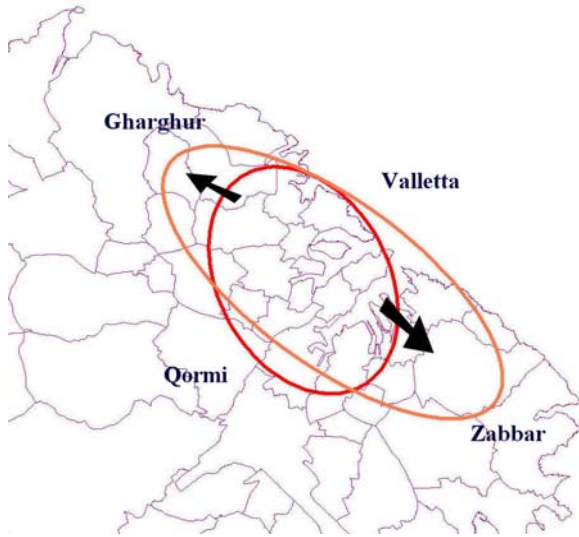


Figure 9.14a: 1998 – 1999

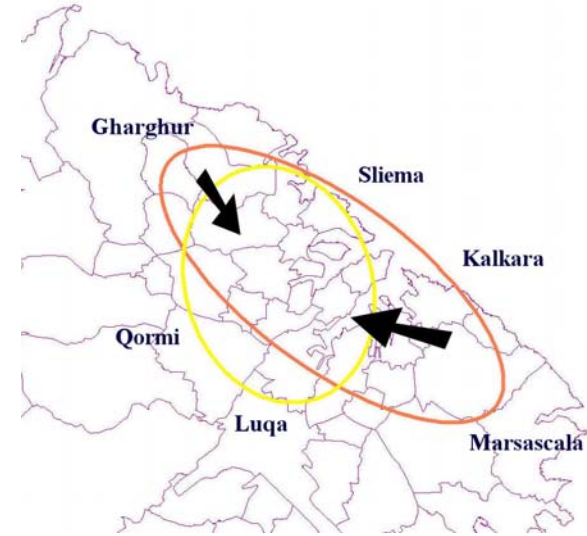


Figure 9.14b: 1999 – 2000

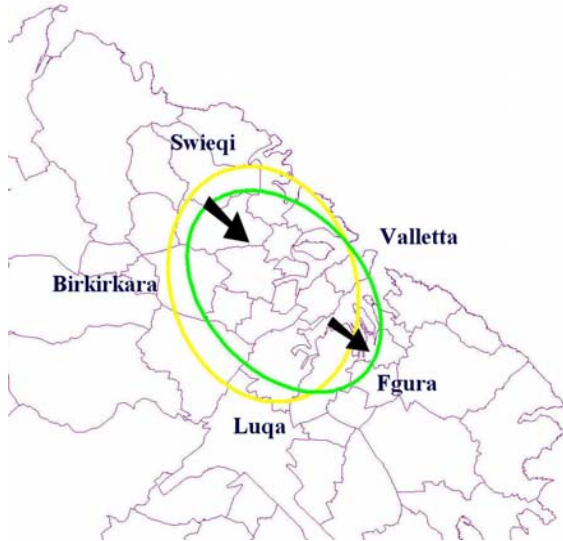


Figure 9.14c: 2000 – 2001



Figure 9.14d: 2001 – 2002



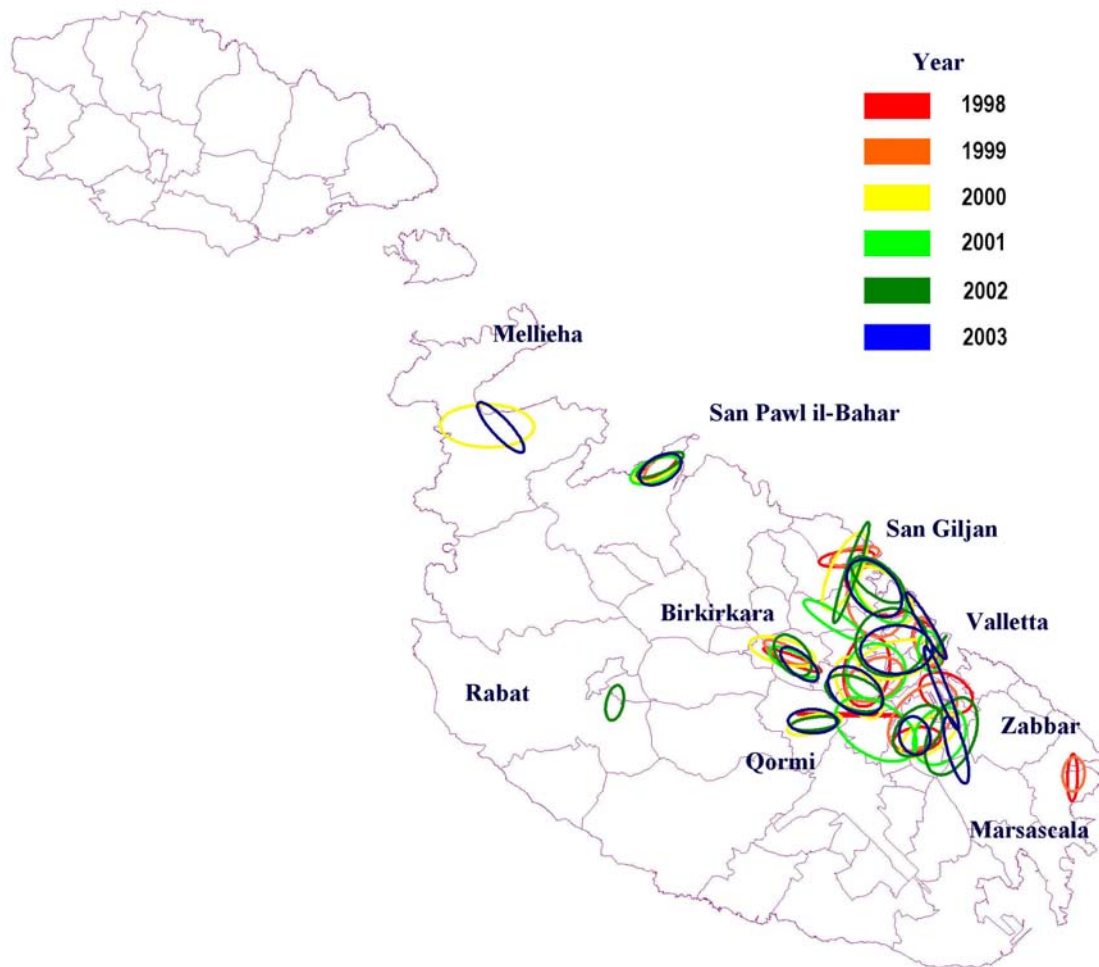
Figure 9.14e: 2002 – 2003

An analysis at 2NNH gives a broader overview of the main clusters that are easier to review at local council level (NUTS5). The general 2NNH map shown in Figure 9.15 gives a first impression of the main cluster of hotspots around the conurbation plus four other hotspots in the main leisure localities of Mellieha, San Pawl il-Bahar and Marsascala plus the historical city of Mdina and its suburb Rabat.

The 2NNH 1998-1999 (Figure 9.16a) analysis shows that the main changes reflected the 3NNH movements, particularly of movements of offences to localities centered around the Southern Harbour region. The fringe seaside localities of San Pawl il-Bahar and Marsascala as well as the central Birkirkara locality retained their hotspot concentration.

The 1999-2000 (Figure 9.16b) comparative analysis shows that Marsascala lost its hotspot with a new one being created in the furthest northern town of Mellieha. However, the Northern Harbour localities of Pieta, Pembroke and San Giljan saw movements out of the area towards more southern areas and into such localities as Qormi, the latter being one of those localities that fluctuates by year, decreasing over the next period and again increased in the 2001-2002 period, eventually stabilising in the 2002-2003 year.

Figure 9.15: 2NNH (Spatial Clustering) inter-annual change analysis 1998-2003 - at 25 points minimum per hotspot



The 2000-2001 reflects the 2NNH with a slightly compacted move towards the Southern Harbour region from the Western district towards Marsa, and Paola (Figure 9.16c). This movement continued over the next two annual-changes (Figure 9.16d-e) with consolidation of hotspots in most Western and Northern Harbour region localities, particularly the most populated town Birkirkara, San Giljan, Qormi and Hamrun as well as San Pawl il-Bahar in the North.



Figure 9.16a-e: 2NNH (Spatial Clustering) inter-annual change analysis 1998-2003 - at 25 points minimum per hotspot



Figure 9.16a: 1998 – 1999



Figure 9.16b: 1999 – 2000

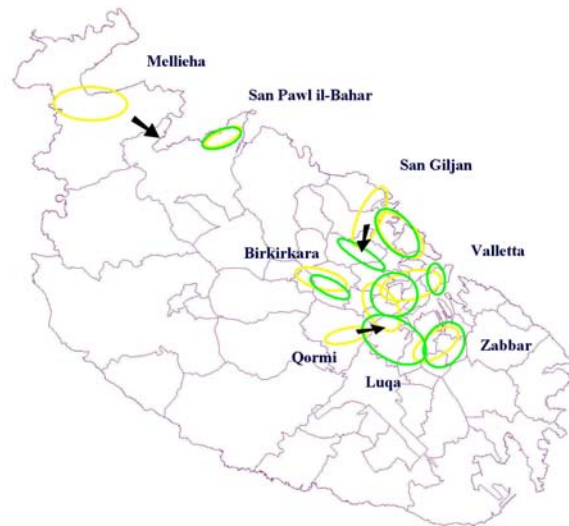


Figure 9.16c: 2000 – 2001

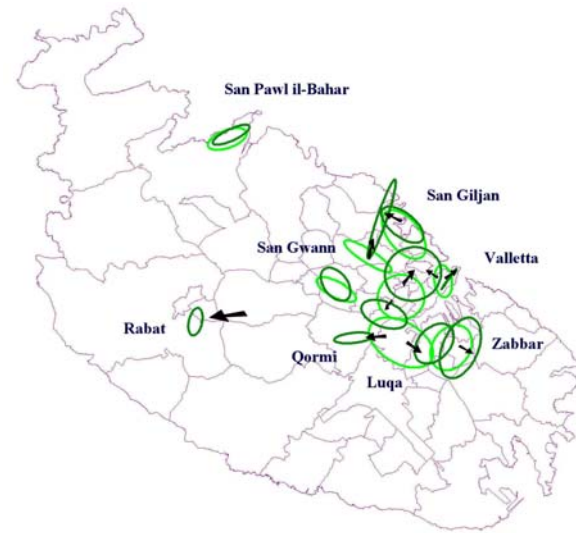


Figure 9.16d: 2001 – 2002

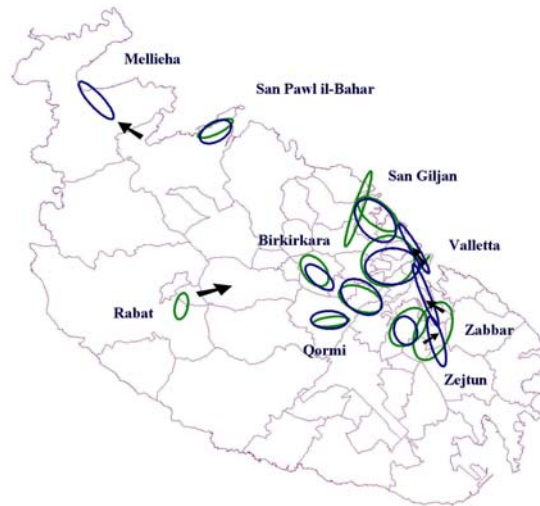


Figure 9.16e: 2002 – 2003

Once the spatial clustering results have been discussed the main issue at stake at this stage concerns the functionality of such maps. Whilst in Chapter 8 the offenders' residential clusters were analysed and were shown to be very distinct since they were based on a small sample of 2000 persons living in specific areas, the case for this chapter's offence 99Kplus analysis is a different matter.

Offences analysed on an annual basis are very volatile as the small 2NNH maps (Figures 9.15a to e) show where some ellipses continuously disappeared and appeared again as in the case of Melieha in the north of Malta. This would be compounded even more at 1NNH level with very small ellipsoids flicking on and off at every annual run. However, at a higher level at 3NNH the ellipsoids are more stable and serve a specific purpose of guiding regional decision-making towards concentration of preventive services within the ellipsoidal area and immediate surroundings.

In the case of Malta, police districting could be changed and further refined to reflect such changes as well as enable predictabilities of flow through analysis of landuse and social activities. Instead of the current 11 districts comprising 20 cross-boundary divisions (Figure 6.12), the areas outside of the ellipsoidal boundaries would review their offence component and undertake amalgamation between districts, whilst the districts that overlap on the hotspots would be reorganised to reflect offence rates. An example would be the Valletta District may be amalgamated with another district considering its population loss (without removing surveillance of the areas where offenders live). In turn, San Giljan could be given its own District considering the large number of offences occurring there.



Also, using this method and knowledge on landuse and social issues, one can predict where offences would occur in the future in relation to new development being built such as new massive construction projects in Tigne (the tip of Sliema) presenting entertainment patterns issues over time and space, leading to the potential migration of revellers from San Giljan to Tigne.

At more detailed levels, 2NNH and 1NNH maps can be used to pinpoint area specific hotspots and take action at an operational and tactical level, where the individual policepersons can patrol. Needless to say, the tool's results are not the end but a means to an end, thus they require review in conjunction with other information such as available human resources, field-knowledge and crime-specific issues such as management and intervention for each different scenario.

#### 9.2.4 Summary

Offences are concentrated in a relatively small area of the Maltese islands, within the conurbation with unique hotspots in fringe localities that are mainly recreational by function. Offences fluctuate over the years but have generally kept their hotspots concentrated in a small number of localities. In summary, most crimes are slowly migrating towards the southern areas of the conurbation.

### 9.3 The Spatial Construct

Having established the main spatial and temporal characteristics of offences in the Maltese islands, it is vital at this stage to try and elicit any relationships between these offences and the areas designations<sup>163</sup> they occur in. This section looks at landuse issues from an administrative and functional categorisation point of view. It attempts to understand the relationship between the different spatial levels and offences.

This set of questions looks at the different functional and thematic levels and how they relate to crime. It seeks to understand if there is a distinction between rural and urban crime and whether the coastal localities, the UCAs and the older areas suffer from higher crime rates than the rest of the locations. Each is briefly investigated in order to elicit the highlights pertaining to that level.

---

<sup>163</sup> Designations refer to the type of spatial categorisation as defined by the MEPA: inclusive of urban and rural, UCA and Village Core, and coastal and medieval cities.

### 9.3.1 The urban-rural parameter

As described in previous sections, the urban-rural debate in Malta is an ongoing one, with this study designating rural areas as those that fall within the Out of Development Zones as defined by the Malta Environment and Planning Authority. The rest are designated as urban areas.

*Research Question: Do urban areas have higher crime rates than rural areas?*

From a total of 99,575 offences reported between 1998 and 2003, 9,953 are committed within the rural area, which reaches up to 10% of all offences. The rest (89,376 or 89.8%) are committed within urban areas with another 246 (0.2%) being committed on ships or planes.

Prior to investigating crime in the main urban context, the rural context is analysed in more detail in order to look at the specificities of offences committed therein.

*Research Question: Are rural crimes highly specific?*

Offence analysis as committed within the rural areas indicates that there is no one crime category that is highlighted over the rest. Most categories number less than 10% of the total national offences in that category. The main exceptions include 'burglary other' (23%), drug offences (12%), criminal damage (11%) and 'theft other' (12%), indicating that these offences are related to rural activities such as drug cultivation, damages to crops, animal theft, etc.

A further analysis shows that within the rural-crime component, the main reported offences are 'theft other' (29%), criminal damage (26%), vehicle crime (24%) and theft from leisure and recreation areas (11%). This finding once again indicates the specificity of the crimes such as 'theft other' which again includes animal theft and crop theft. Interestingly, whilst rural drug offences was relatively high in terms of the total urban-rural offences at 12%, but they make up only 0.4% of the rural component. This indicates that nationally drug offences are low in number but they are found predominantly in the rural areas. 'Burglary other' also shows that this trend with a 1% within-rural component as against a 23% national rate. Conversely, vehicle crime, though high within the rural component, is relatively low as compared to the 9% national offence total counts. This indicates that most vehicle crime occurs in urban areas.

### 9.3.2 The coastal parameter

At another functional spatial level: the coastal area offences help the analyst to understand whether this unique group of councils have a distinct offence signature than that of other areas.

Seaside local councils, as used for this analysis take up a large part of the Maltese land and also harbour most economic activities.

*Research Question: Do coastal towns have higher rates of crime than elsewhere?*

As against the non-coastal offence component, coastal areas host a very high percentage of offences, mainly due to the fact that the highest recreational and residential densities fall within the coastal areas. This is evidenced by a 60% component of theft from retail and leisure areas as against the 40% for all the non-coastal areas. The rest of the crimes average 30% of all crimes, except for homicides that during 2001 and 2003 reached 50% and 67% respectively.

### 9.3.3 The village core parameter

Following the analysis of the seaside towns which are relatively new areas, at the opposite end of the scale one finds the old areas that have suffered a population loss. The relative deterioration and human loss may result in different crime offences should the Broken Windows Theory be relevant in the Maltese context.

*Research Question: Do village cores have a higher rate of crime than newer areas?*

The UCA\_VCs are investigated for their offence component with the most significant offences being serious offences as are drugs offences (41% of all national offences) and assaults (40%).

Interestingly, whilst most of the crime categories average 30% of all crimes, this result indicates that village cores do not host higher rates of crimes than the newer areas. However, the highest remain violence against the person, serious and slight wounding, burglary dwelling, 'theft other', fraud and forgery and criminal damage. This indicates that a relatively large number of serious offences are found within the village cores. Such results to some extent indicate adherence to the Broken Windows Theory that can be further analysed through a study of the old cities' crime situation.

### 9.3.4 The old medieval cities parameter

*Research Question: Do the old cities have a higher rate of offences than elsewhere?*

As against the UCA\_Village Cores analysis, the old walled cities of Valletta, Bormla, Birgu, Isla and Mdina, characteristically exhibiting a declining population in all but Isla, show that very little offences occur here totalling 1,533 out of 17,773 in 2003., averaging 9% of all crimes, with

the highest being ‘theft other’ (12%), common assault, forgery and drugs, each at 11%, followed by violence against the person at 10%.

This relative small offence component indicates that more ‘personal’ crimes as against high-yield property crime are found in these areas. The old areas are not high attractors for offences decreasing in 3 cases (Bormla, Birgu and Mdina) but increasing in Isla and Valletta. The latter has a large retail and leisure component and is the fourth highest offence-registering locality in the Maltese Islands at 6.14% share of the 2003 national score (Table 9.8), a figure that has been steadily increasing since 2000. The other localities do not register very high in the league table of offences, in fact having 0.37% from Mdina to 1.13% of the total reported offences for Bormla. Isla and Birgu registered 0.5% and 0.48% respectively.

*Table 9.8: Walled Cities offence league table: 1998 to 2003*

	Offences % 1998	Offences % 1999	Offences % 2000	Offences % 2001	Offences % 2002	Offences % 2003	Offences % Change 2002-2003	Population % Change 2002-2003
Valletta	4.25	4.84	3.97	4.24	5.31	6.14	Increasing	Decreasing
Bormla	1.44	1.46	1.27	1.26	1.17	1.13	Decreasing	Decreasing
Isla	0.62	0.65	0.47	0.45	0.38	0.50	Increasing	Decreasing
Birgu	0.68	0.63	0.50	0.48	0.67	0.48	Decreasing	Decreasing
Mdina	0.34	0.37	0.46	0.41	0.52	0.37	Decreasing	Increasing
<b>Total Walled Cities</b>	<b>1,156</b>	<b>1,276</b>	<b>1,137</b>	<b>1,089</b>	<b>1,373</b>	<b>1,533</b>		
Total Malta	15,771	16,046	17,030	15,912	17,043	17,773		

### 9.3.5 Summary

An area designation analysis shows that the Maltese islands experience a predominantly urban-related crime scenario, except for such categories as drug offences, which are more evident in rural areas. On the other hand, coastal areas register highly in retail-related offences, whilst low on other offence categories. With respect to the historical village cores and the medieval cities, these exhibit lower offence rates though for such offences as assaults and drugs, the latter are relatively high, indicating a specificity for crime urban state category.

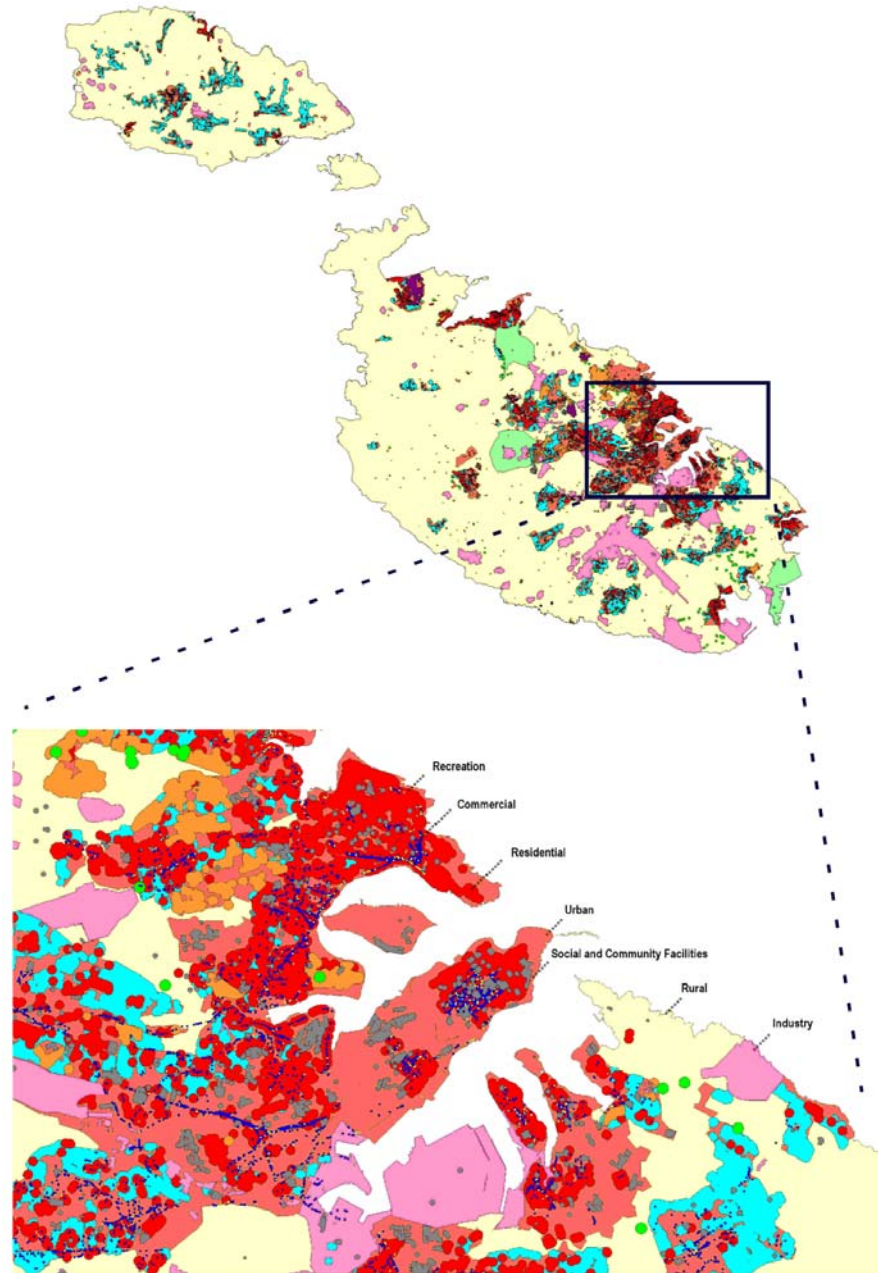
## 9.4 The Structural and Use Constructs

Having briefly described the different spatial functional constructs, the next phase attempts to elicit the relationship between crime and the structural and use components as defined by planning zones: housing, commercial, industrial, etc. This section attempts to understand if there

is a relationship between crime and the use to which a location is put, where it occurs, and which offences are more prevalent.

The main zones analysed were categorised into social and community, residential (all combined categories listed in Chapter 8), industry, commercial, recreation, country parks, as well as the extents to development.

*Figure 9.17: Landuse zones*



A map was created using address point data that generated residential, commercial and retail buffers. Each resultant buffer was integrated with the other categories, such as industrial polygon

layers, social and community facilities, and retail. The final result is depicted in Figure 9.17 which shows a map of the areas with a detail of the main categories except parks that are identified by a pale green colour in the islands map and development zones as cyan areas. Note that the term urban is used for all the areas within the limits to development that are included under the specific residential and other categories.

In order to avoid falling into the analytical trap identified by Harries (1981) that the usage of the resident population serving as a denominator is erroneous when analysing offences, in this study the resident population are not considered as part of the exercise, instead concentrating on the usage to which that area has been put.

#### 9.4.1 The main zoning parameter

The series of analysis reviewed in the following section identifies each of these categories in relation to offences and tries to elicit which areas attract most crime. It also attempts to review the relationship between zoning and offence types.

*Research Question: Is there is a relationship between landuse zoning and offence type*

The residential areas comprise the majority of offences in the Islands with residences taking up to 44% of all offences with a higher relative percentage of serious offences registered than the non-serious category. At 43,931 offences occurring within the residential areas, this component is very large and is best further analysed through type of crime analysis, shown later in this section.

Figure 9.18: Offences by landuse zones

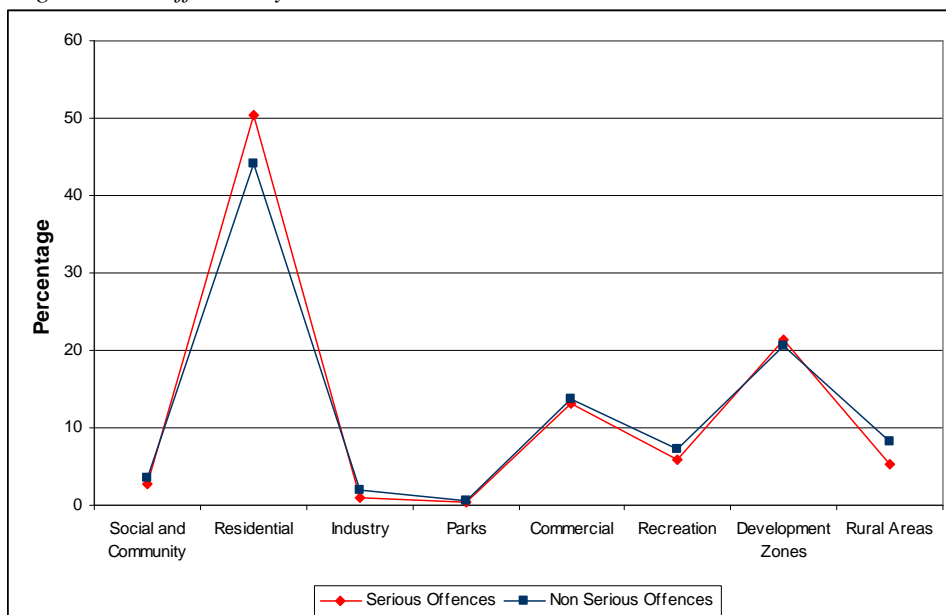


Figure 9.18, in its review of seriousness by area, shows that the only category where serious offences exceeded the non-serious in a relative percentage analysis was the residential area. Other categories such as the commercial and the social-community zones showed nearly equal relationship.

Whilst residential areas comprise the larger part of offence location, the next largest category of offences fall within the development zones (21%), which includes areas being built up and those within the planning schemes (Table 9.9). This is followed by commercial areas at (14%), rural areas (8%) and then recreation areas at 7%. The latter can be integrated with the commercial areas since it is a sub-category of commercial and both fall within closely clustered areas. In effect, the commercial and retail areas add up to 21%, registering the second highest landuse category equal to the development zones. Refer to Table 8.29 for more detailed data.

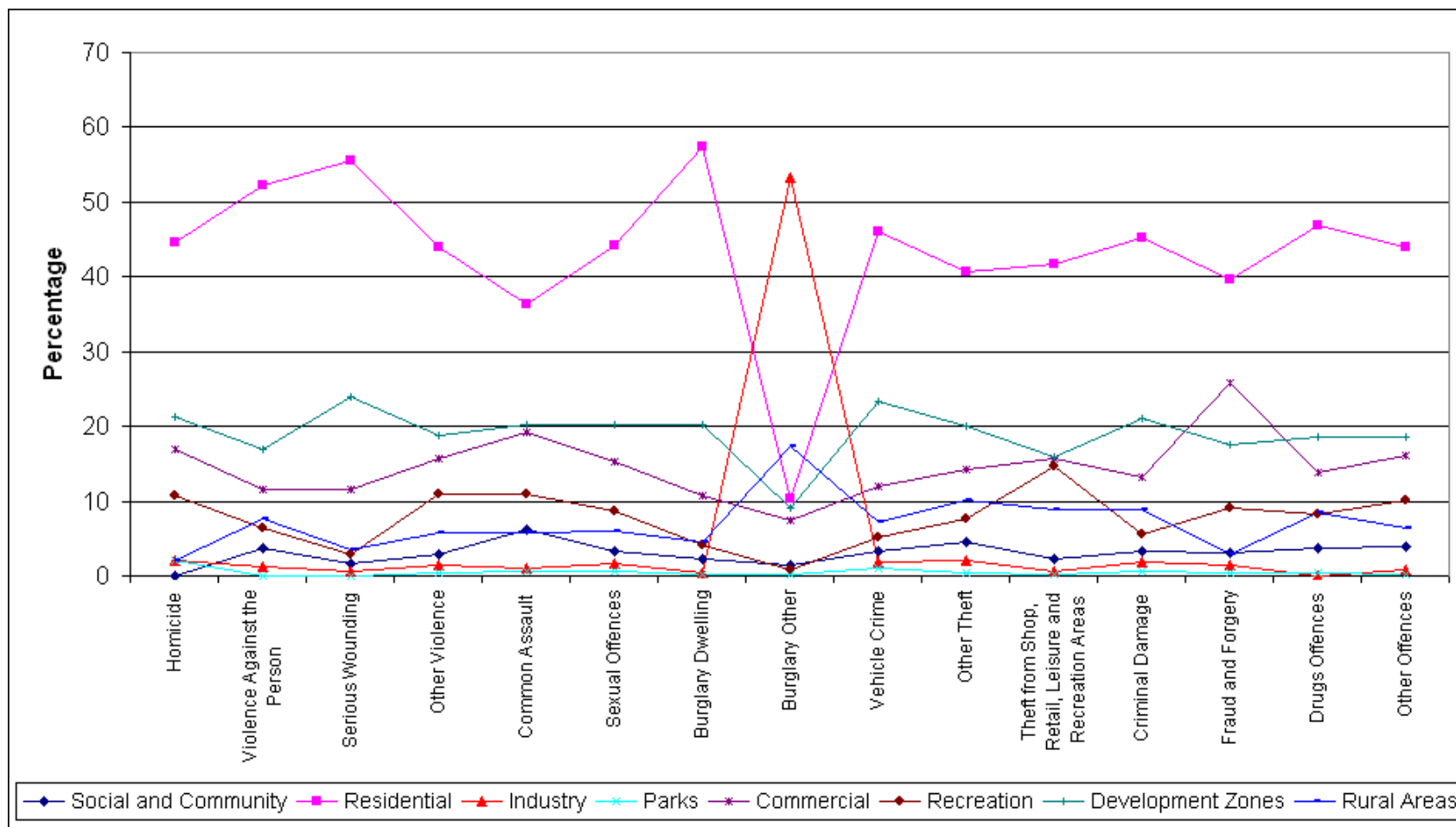
*Table 9.9: Offences by landuse zones*

Zoning Comments	Serious Offences	Non Serious Offences	Total Offences
Social and Community	2.65	3.47	3.44
Residential	50.33	44.06	44.23
Industry	1.04	1.92	1.90
Parks	0.31	0.58	0.57
Commercial	13.14	13.71	13.70
Recreation	5.88	7.34	7.30
Development Zones	21.32	20.58	20.60
Rural Areas	5.34	8.33	8.25
<b>Total</b>	<b>2,603</b>	<b>96,729</b>	<b>99,332</b>

Figure 9.19 depicts the main landuse categories and offence rates, showing relatively stable rates across the landuse categories, with some fluctuation in the new development zones, the commercial and recreation zones. The rest exhibit very low composition in crimes and also very little fluctuation between the different categories.

Residential areas, having the highest percentage of reported offences also exhibit high rates in nearly all categories except ‘burglary other’ and relatively low for common assaults. ‘Burglary dwelling’ is high as is serious wounding and violence against the person. The latter would include domestic violence and other related incidences.

Figure 9.19: Offence category by Landuse Zone: Percentage





A more detailed analysis of offences by zone and by category shows distinct offences that fall within particular areas, with cases easy to review such as a peak under ‘burglary other’ that can only be found in the industrial and rural sectors. Such a case is highly specific since very few ‘burglaries other’ can occur in residential areas where most of these have a specific burglary category. Though some do occur in residential areas, this is due to a number of industrial (small and medium sized) entities that are located within the residential zones; case in point being carpenters and panel beaters.

Interestingly, though residential areas hold a large volume of crimes, they also have within them a sizeable component of thefts from shops and leisure areas. This is true due to the particularity of Maltese land use, having a predominantly mixed-use composition, which results in such cases as commercial and retail-related offences within the residential areas.

In addition, retail-related offences spill-off into the residential areas. A case in point refers to the San Giljan recreational zone which hosts the main bars and restaurants groupings but since it does not host parking facilities, the real offence category that peaks in this area is related to vehicle-related offences in the areas of Paceville, San Giljan and Swieqi; areas that are residential by zoning. Considering that throughout the study, San Giljan crops up so often particularly due to its recreational activity, such a situation is analysed in more detail later in this chapter.

#### 9.4.2 The commercial parameter

Moving away from the residential-offence scenario, a case-study approach is taken that attempts to look at non-residential areas and the relationship between offences and the main retail areas. The first categorisation is based on commercial and retail areas as designated by the Malta Environment and Planning Authority (MEPA), which identified a specific number of councils into town centres. These town centres are mainly split into two categories: primary (9 areas) and secondary (12 areas), which titles clearly indicate the importance of the locality as a clustering of commercial activity.

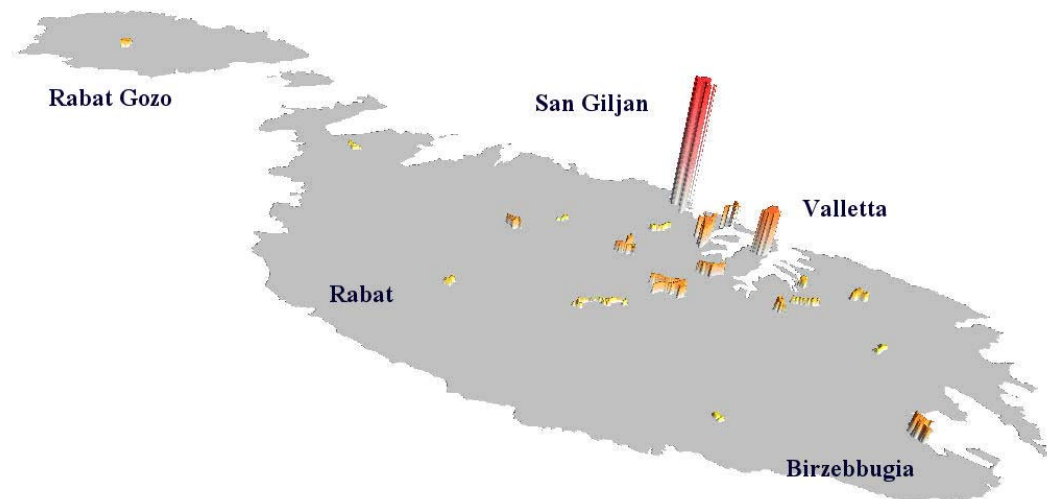
*Research Question: Do town centres host higher crime rates when ranked by category of town centre?*

These centres between them hosted 16,322 offences or 16% of all reported offences. These occurred in areas that host 4,618 commercial/retail units or 29% of all such units in the islands.

One has to note that some of these centres also comprise residential units and other zoning categories, however, in their larger part they host retail entities.

Crime rates in both centre types saw a gradual increase in the number of offences over the last three years, increasing from 15% to 18% of all crimes. The main localities taking up the bulk of these offences relates to the conurbation town centres particularly the San Giljan area, followed by Valletta. Refer to the two highest peaks in Figure 9.20, which also shows the proportionality in which the offences occur within all the town centres.

*Figure 9.20: Town Centre Offences: 3D map*



#### 9.4.3 The recreational parameters

One commercial activity that was targeted for analysis in this study, refers to the issue of recreation, which is related to the seasonal land use and town centre activity.

A decision was taken at this stage to analyse one activity (zoning) variable against the types of crime committed within that offence location and the surrounding buffer zones. Such a study would enable an analysis of the types of crimes that one finds in the location and the surrounding areas. Since residential areas were analysed in the previous Chapter, the next best zoning area to test buffering analysis is retail zoning. This aids the town centre analysis through a more detailed review of these areas and how they operate.

For this purpose, buffers were created at 50m, 100m and successive 100m intervals<sup>164</sup>. Queries

---

<sup>164</sup> The footprint buffer was created based on an actual entity location plus a 10m buffer that encapsulated the blockface area which includes those entities facing the retail units under analysis (Hyatt *et al*, 1999: 18).

were run aimed at gauging the number of offences within each buffer, by crime type, and serious and non-serious category. Figure 9.22a-f show images of one such area which has been identified as the highest offence area in Malta: San Giljan and its recreational area known as Paceville.

*Research Question: Do the results from 'buffering analysis' show differing rates of crimes by type with distance from activity area centre? How far is crime generated by the concentration of the recreational activities?*

In synthesis, crimes are high in the retail footprint areas, increase by buffer distance for the first 400m then start declining up to 1000m. The analysis of offence categories by retail vicinity shows that 15% of all crimes occurs within the footprint zone (retail area) (Figure 9.22c). This analysis indicates that most offences occurring in this initial zone are made up of 'theft other', theft from retail areas, criminal damage, and vehicle crime. These categories total 84.21% of crimes occurring in the footprint zones. This trend can be found up to 400m from the retail units, which finding signifies that the offences categories are linked to the retail activity. For example, theft from shop or retail is naturally high in the immediate footprint area and decreases with distance.

In fact, this theft category, which hosted 2,766 offences in the 1998-2003 period, saw a decrease in crime with every 100m buffer, indicating a relationship of offence by category with distance from the zoning category. Figure 9.21 graphically depicts this decline. Interestingly, 'other theft' which is the highest category in this zone, increases slightly up to 50m from the retail entities and then starts declining by distance. This type of offence includes theft from person, snatch and grab, pick-pocketing and general theft such as mobile phone theft. This is not surprising, considering that the Maltese climate is very mild and allows human interaction outside of the retail areas and in the streets such as the notorious Paceville streets where revellers stay outside on the streets drinking, partying and socialising, irrespective of the season type, except for stormy winter nights. This 'target zone' can be identified up to 50m from the entity footprint<sup>165</sup>, which buffer is included in this study (Figure 9.22d). Thus, in the case of 'other offences' these are high in the footprint area (24%) and in the 50m zone at 25%, then decline slightly and sustain this high rate of crime up to 400m.

---

<sup>165</sup> Entity footprint is designated as retail in Figure 9.21

Figure 9.21: Retail offences by buffer distance

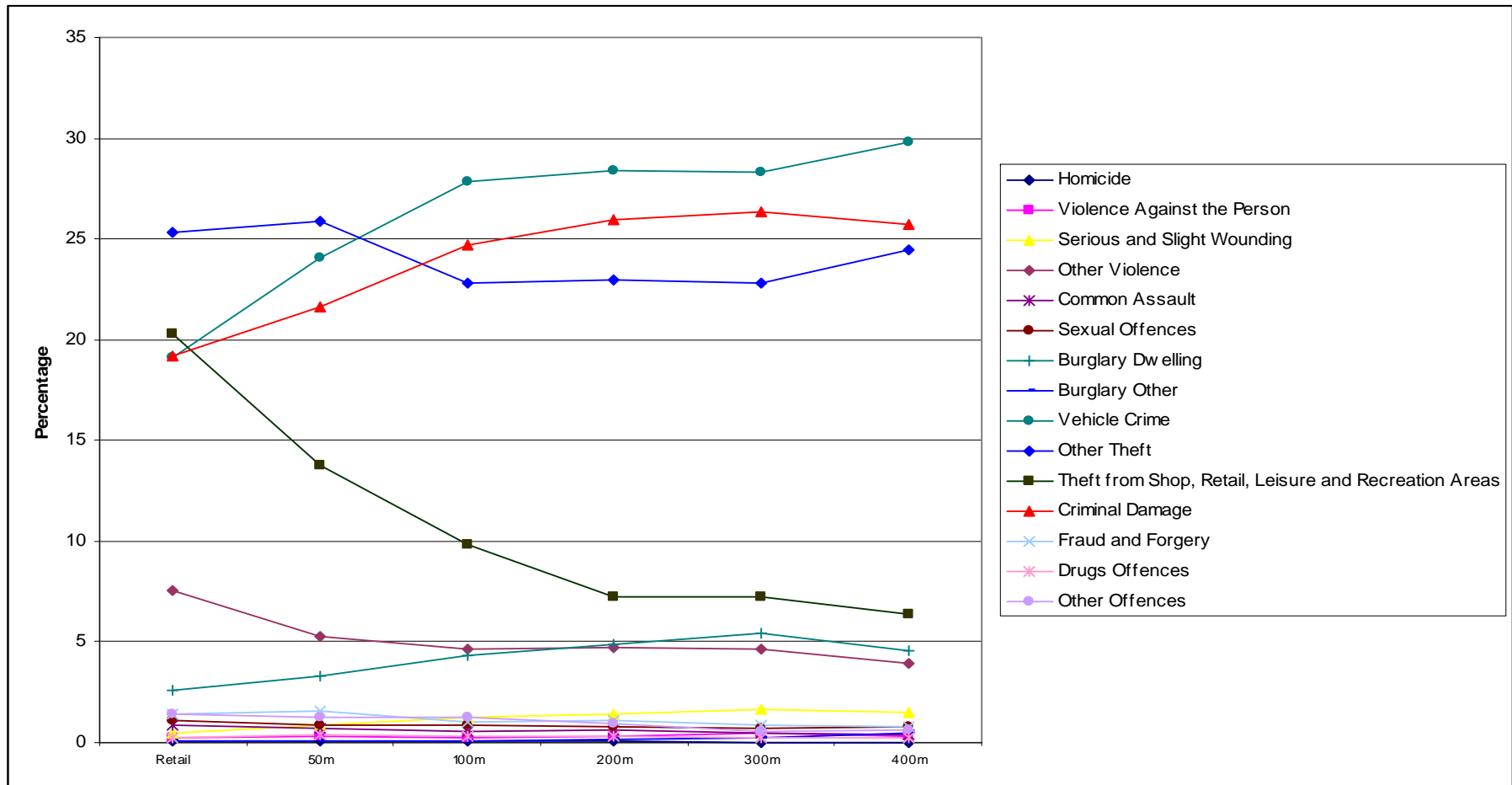


Figure 9.22a-d: Photos of Paceville recreational zones



Figure 9.22a: Aerial Photo: 2004 – Source MEPA (marked areas indicate photo locations)

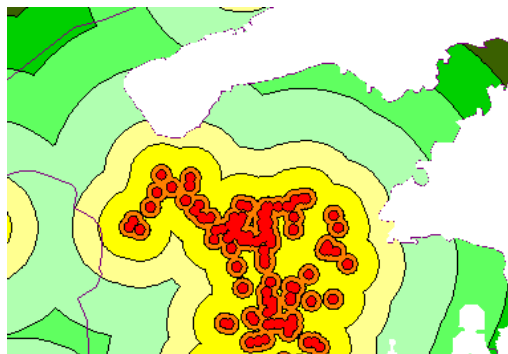


Figure 9.22b: Buffer Zones (red-orange: footprint zone, yellow-target zone, the rest represent successive buffers)



Figure 9.22c: Footprint Zone



Figure 9.22d: Target Zone



Figure 9.22e: Residential Zones



Figure 9.22f: Dragonara Road, Paceville, San Giljan

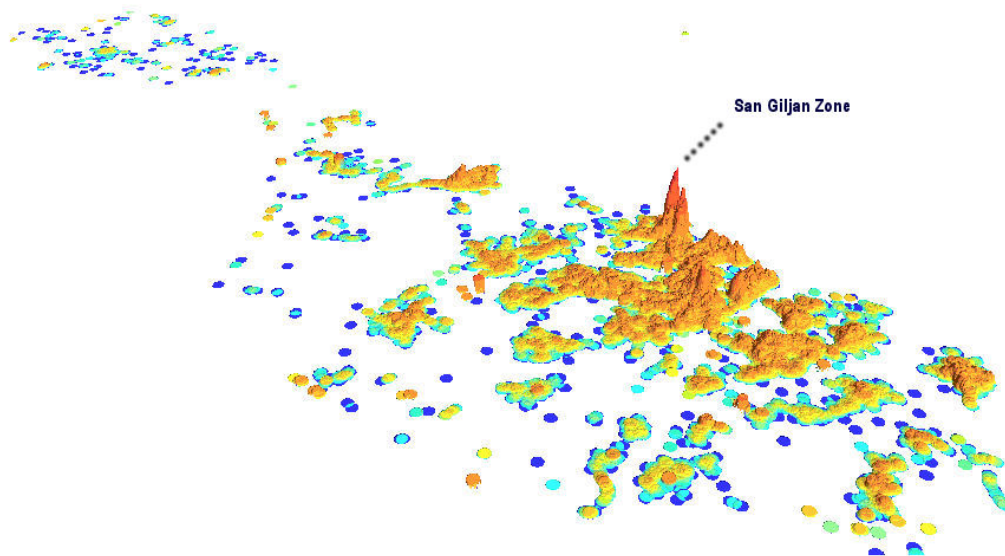
In the case of vehicle crime and criminal damage, which includes damage to vehicles and property, offences increase by distance. Though high in the first zone at 19% in both cases, they increase to 30% of all offences for vehicles and 26% for criminal damage at 400m. This type of change is understandable since the offences fall within the zones that people tend to park in, principally the immediate roads that intersect with or are on the periphery of the recreational area. With few official and secure car parks in the vicinity of the retail areas, visitors to the area

park anywhere in the vicinity, flowing out to the neighbouring streets and main roads (Figure 9.22e). This results in high vehicle crime in the these buffer zones both in term of theft from cars, theft of cars and damages to both cars through tempering and damages to homes in the vicinity. The latter, is also evidenced from the slight increase in dwelling burglaries in the distant buffer zones.

In addition, street lighting conditions were very poor in the area during the period under study, particularly Dragonara Road in Paceville, which took up 13% of offences in the highest crime-hosting locality (Figure 9.22f). This road, in isolation, highlights the severe problems that this area experiences. More detailed analysis is needed in this area by type of offence, accessibility, lighting conditions, etc, particularly since the installation of lighting and CCTV in specific areas. Photos of the areas under review are listed under Figure 9.22.

Figure 9.23 shows a 3D map of the extent to which this Paceville peaking occurs where a very small cluster of roads spreads offences in all the neighbouring areas.

*Figure 9.23: 3D point density – vehicle crime*



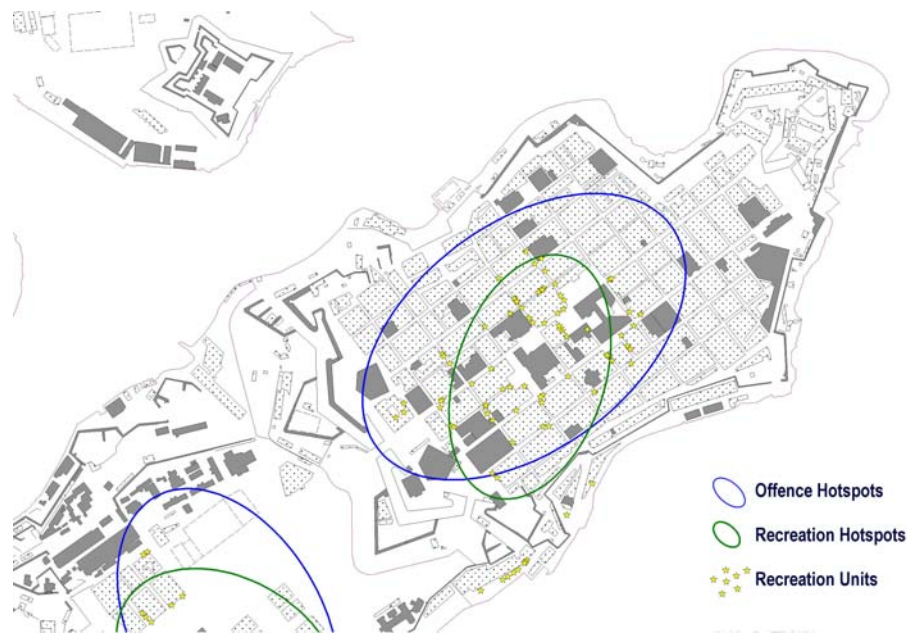
The other significant offence that shows a specific relation to retail areas concerns ‘other violence’ that includes assault and general bodily harm. At the footprint zone, though relatively low at 7.6% in comparison to retail theft and vehicle crime, it is still quite high at 1,034 incidences, in respect to all the other offences committed in the area. The incidences decrease slightly up to the 200m buffer and then decline by half at 300m with successive declines over distance. This type of offence is highlighted for its importance in relation of very serious crimes that occur in places of crowding and calls for further studies in the area.



A spatial analysis based on NNH clustering shows that 714 of 1479 (48.3%) recreational units fall within a few hotspots<sup>166</sup> indicating high rates of concentration of retail units, whilst 866 (58.6%) of these units also fall within the geopol<sup>167</sup> offence hotspots. Such a finding shows that a high rate of recreational units fall within the main offence hotspots and are more liable to become targets of crime. This is confirmed through an intersect analysis of hotspots generated for the two variables, which results shows that 82.4% or 28 out of 34 recreational zone hotspots fall within or intersect with offence hotspots.

Most of these areas fall within the main recreation and commercial towns inclusive of San Giljan, Valletta, Rabat – Gozo (Victoria) and San Pawl il-Bahar. Figures 9.24a-d depict these localities' offence and recreation hotspots intersections as well as the retail units location. They are aimed to show how closely related the two types of hotspots interact. The Valletta, San Giljan and Victoria recreational hotspots are found intersecting or totally within the offence hotspots whilst San Pawl il-Bahar is composed of a series of hotspots that highlight the three main sub-localities of San Pawl, Bugibba and Qawra, each having its distinct recreational area separated from the rest by residential units. Note that as in the offender- poverty analysis, all councils' maps were generated as part of the study, and Appendix 10 depicts the maps of those local councils' that have recreational and offence overlaying hotspots.

*Figure 9.24a: NNH geopol hotspots overlaid on recreational hotspots - Valletta*



<sup>166</sup> (1998-2003) at 25 points minimum per hotspot

<sup>167</sup> GEOPOL – reported offences to the police as per PIRS output

Figure 9.24b: NNH geopol hotspots overlaid on recreational hotspots - San Giljan



Figure 9.24c: NNH geopol hotspots overlaid on recreational hotspots – Rabat – Gozo (Victoria)





Figure 9.24d: NNH geopol hotspots overlaid on recreational hotspots - San Pawl il-Bahar



#### 9.4.4 Summary

In summary, the 'Use' construct shows that residential areas are the highest offence targets, though they host spill-overs from other activities such as retail. Residential areas also have a high serious-crime component. Commercial activities, on the other hand, generate large amounts of crime, specifically offences that emanate from such activity, particularly person-related crime such as 'theft from person', snatch and grab and pick-pocketing.

However, a deeper analysis shows that offences in the recreational areas are related to distance in that the category of crime depends on the distance traveled from the retail entity. A cluster analysis shows that there is a relationship between offences and retail. The analysis also showed that San Giljan, particularly its Paceville sub-locality keeps hitting the top mention in all the offence analysis categories.

### 9.5 Conclusion

This chapter reviewed the main offence parameters as related to the landuse aspect. The analysis was based on an initial review of the seasonal impact on crime, through a temporal dimension. It

then reviewed offences by spatial units and levels of aggregation such as NUTS5 and NUTS4 as well as taking a deeper analysis of point-based data in order to elicit more detailed relationships.

The study also sought a 'use' analysis concentrating on the recreational landuse category through a detailed buffering analysis.

In summary, the main issues resulting from this analysis show that Malta experiences high summer rates of crime by month, which is subsequently offset by winter incidences where specific weekend to weekday differences are highlighted. In addition, an hourly analysis shows that most night offences are comprised of serious and vehicle-related offences.

Spatial analysis resulted in offences being concentrated in a relatively small area of the Maltese islands, within the conurbation with unique hotspots in fringe localities that are mainly recreational in nature both seasonally and hourly. Also offence locations are slowly migrating towards the southern areas of the conurbation.

A spatial designation analysis shows that Maltese offences are predominantly urban-related, with high rates of retail-related offences in the coastal areas, and lower overall rates within the village cores and medieval cities, which host specific person-related offences.

An analysis of use categories identified that whilst residential areas host the highest offence counts, they also serve as spill-overs from neighbouring activities such as retail. Interestingly, residential areas have a high serious-crime component. The more dynamic recreational activity plays host high volumes of crime, which occur in concentrated areas, where offences are mainly property-related.

As recreation was specifically analysed in this chapter, the results show offence type is related to the distance travelled from the retail entity. Cluster analysis shows that there is a relationship between offences and retail concentrations and that San Giljan is the top of the league offence location with increasing offence concentrations amid a slightly increasing population concentration.

With both the social and landuse aspects covered, the CRISOLA analysis has allowed the identification of a diverse number of relationships between the three pivots. The relationships reviewed sought to understand the dynamics of offenders, the offence locations and how they relate to such social issues as poverty and also such landuse issues as is recreation. The next and final chapter brings together these findings, reviews them in light of the literature review and seeks to review data and information lacunae and recommends further research activities.

## **Chapter 10: Conclusion**

### **Introduction**

The study has sought to develop an understanding of the Maltese Islands' crime structure, It aimed to bring together previously non-investigated local relationships of crime to the social and landuse fields. The basis for the linkages between the three CRISOLA constructs has helped build up a focus on the possibilities available for study, which possibilities are only restricted by the availability of data.

The study, the first of its kind I the Maltese Islands, has managed to review crime in it spatio-temporal aspect based on an analysis of location of where offenders live and where they commit crime, as well as analyse criminal activity in relation to the structures of the areas the offenders live in, interact and commit crime. Its targets were met through a review of the spatial distribution of crime in Malta through offence statistics, the analysis of criminogenic areas through offender-offence analysis and the relationship of crime to social and landuse issues.

This conclusion reviews those findings, in light of the research questions set and also lays out those areas that need further investigation.

Note that the findings are specific to the time-scale they are investigated in. The different currencies available for the datasets posed a limitation on this study that restricted a deeper study into the offender-offence dynamics. The gap in comparative analysis identified in the analysis between Chapters 8 and 9 is due to the different time periods for which data was available: 1950-1999 for the offender analysis (Chapter 8) and 1998-2003 for the offence analysis (Chapter 9). Such diverse time-currency on the data limited the application of comparative analysis between the two chapters. However, in the case of the offender-offence analysis in Chapter 8, such was possible since the 1990-1999 offences committed by incarcerated offenders was compared to the socio-demographic data of the same offender.

### **10.1 Conceptual Model and GI**

One main process covered in the study resulted in the creation of a mindmap that enabled the author to review the available theories and understand how the relevant relationships could be analysed. A three-phase conceptual model was created that helped to understand the spatial and temporal aspects functioning in such a structure and served to highlight the potential relationships between the CRISOLA constructs.

This study was based on a quantitative approach, which sought to make use of formal statistical measures but relied on employing the spatial statistical factor. The process entailed a long-winded data gathering, cleaning and design process which is required to produce a spatial framework for a crime study of this type.

This process was enabled through the employment of such high-end information systems as GIS that enhanced the usage of spatio-temporal techniques within a large-volume dataset structure. This was made possible through the use of specific statistical tools as integrated within GIS, which in this study was based on diverse measures as hotspot, Standard Deviational Ellipses, nearest neighbour hierarchical clustering and 3D analysis, amongst others.

The project created the first web-enabled Crimemap system for the Maltese islands based on crimes reported to the police between 1998 and 2003.

#### 10.1.1 The target area

Whilst small and insular, Malta has its own peculiarities in the CRISOLA constructs, based on a history dominated primarily by socio-political issues but more pressingly by issues related to landuse, with increasing development pressures due to sprawl, population loss, historical area neglect and economic variance. This has resulted in a dynamic structure that when reviewed from a criminological point of view has highlighted the need to study crime patterns with a potential link to the social and landuse issues.

## 10.2 Research Findings

#### 10.2.1 The international scenario

Taken from a global to national to local scale analysis, the study has managed to highlight Malta's position in a world of crime, its national and regional peculiarities and the realities in the field. This was carried out through the question to place Malta in a criminological framework over space and time.

The initial step to identify Malta's position in an international scenario was based on the analysis of European and Small Islands level. This helped show that Malta is a relatively safe country. At a European level, Malta shares the same group as its immediate European neighbours, whilst at the islands level, results show that it shares a structure to a similarly sized island cluster. Malta is

placed within relatively safer (low-rate) groups in both levels, with below-the-mean figures for most crime categories. One surprising result shows that Malta experiences a crime structure that is closer to the EU level than the Islands' level, where the latter experiences higher rates of serious crimes and lower rates of non-serious crimes. Such an analysis was carried out through a crime-mean measure analysis model, which methodology resulted in a score model that placed Malta at the different spatial levels within a relative safety-dangerousness scale. Such shows that Malta was deemed safe, though progressively decreasing in relative safety.

### 10.2.2 The historical scenario

Results show that Malta has experienced a rapidly changing crime history, where a 40-year analysis depicted an increasing crime rate as well as a structural change in crime categories reported over the decades. The figures showed a threefold increase between the 1960s and 1990s, which again nearly doubled over the 1990s-2000s period. Crime changes over time due to the social and economic occurrences experienced by a country and Malta has not been exempt from such changes, as found in Ladanyi's Budapest study (Ladanyi, 2001).

### 10.2.3 The offender scenario

Criminological analysis would be soulless without an analysis of the offender, who is the pivot and the conveyor for criminal transactions. This study sought to review offenders and their social and environmental relationships, their offences and the offender-offence interactivity. This was carried out through a spatio-temporal approach, which identified a number of issues that are characteristic of the Maltese Islands, such as a high foreign prisoner component, highly-specific social situations for local offenders, evidence of residential and poverty clustering and offender-offence relationships. These results point towards the existence of a homogenous offender group that exhibits distinct characteristics from similar national cohorts, strengthening the identification of a common social background.

In review, the Maltese prisons host one of the highest relative international component in Europe, steadily increasing over the decades whilst changing in character from a UK-based structure in the 1960s to a Northern African one on the 1990s (refer to United Nations, 2003). In terms of all-offender structure, male adults dominate the scene (in line with Home Office studies, 2002), mainly incarcerated for long sentences closely followed by short sentences with a low female component. Incarceration in Malta has declined over the decades but has seen a resurgence in the 1990s.

In an in-depth study of the Maltese offender component, the results show that the Maltese offender profile depicts him as male, aged between 21 and 30 years old (Entorf *et al*, 2000), a recidivist (Schwaner, 1998), is increasingly less literate and being replaced by semi-illiterate offenders, has had a secondary education mainly in government and trade/opportunity schools (Rutter *et al*, 1979), is single, unemployed (Palermo, 1993; Wang, 1999) and increasingly partaking to serious crimes in line with Greenwood's findings (1982).

In terms of residential preferences, results show that through analysis of offender-hotspot localities and clustering of offenders, there is a significant identification of regionalisation based on a harbour/non-harbour grouping. The offender lives in the conurbation, with increasing migration to the peripheries during the 1990s, originates mainly from the cities of Bormla and Valletta which areas have a disproportionate offender concentration when compared to their shrinking population concentration, lives in highly clustered areas close to other offenders. Also, the offender lives in high population density areas in the old cities and lives in areas characterised by poverty. However, over time, offenders have declined in the conurbation, historic cities and towns, whilst increasing in such areas as seaside towns and housing estates showing a preference to move into the newer as against the older localities. Also, offenders tend to prefer less the UCA as against the Housing Estates. These results show parallels to Todorovich's (1970) Belgrade study of non-central clusters. Harries' (1974) 'ecologies of space' which showed that each particular spatial groups has its own crime characteristics, which in this Malta study is identified by the different offender preferences by locality type.

In analysing the offenders' residential component as against poverty analysis, initial results show that there is no easily discernable relationship between dwelling type and poverty. They also show that poor people live close to the village core but not essentially within. No relationship was found between dwelling density and poverty, whilst the housing estates host nearly half of all poor areas, with particular concentration of the latter close to or within the harbour region. Deeper analysis, concentrating on the offender component show that there a positive relationship between offender density and population density. A spatial study shows that the areas experiencing both high density type are those localities found in the harbour region, those areas that form part of the so-called inelastic cities (Shaw-Taylor, 1998). Whilst population density and poverty resulted in a very weak relationship (Messner, 1992; Entorf *et al*, 2000), a further analysis shows that there is a positive relationship between offender density and poverty risk indicating a tendency for offenders to live in poor areas. Such results reflect Maguire *et al*'s (1997) findings that urban areas have high poverty concentrations, welfare dependency and crime.

The other offender-related component, shows that the offences committed by convicted offenders fall within increasingly high dwelling concentrations, low population density areas, occur in vacant dwelling concentrations and are mostly found within areas zoned for apartments. They are also to be found in Urban Conservation Areas, linked to specific social and community areas such as schools though not for serious crimes. The offence-related studies show that there is a relationship between crime and dwelling density, population density and vacant dwellings. Also most offences occur within apartments, and in buildings situated in the UCAs. However, they are not strongly related to high-poverty areas.

Taking these two parameters together through an Offender-Offence relationships analysis, results show that Maltese offenders, though constrained by geographical boundaries (islands) and a very small area to predate in, they still have a very clear modus operandi, in terms of how they operate, where their targets are and which offences are committed where. Maltese offenders commit crime close to their residence, travel less than 5 Km for most crimes and have a preference for intra-island crime, reflecting a cognitive- area intersection model where offenders commit offences within their own area (Bottoms and Wiles, 1997). With a positive relationship between distance and crime type, drug-related crimes are the most popular for crimes committed close to home, whilst theft increases with distance.

#### 10.2.4 The offence scenario

The final section of the study reviewed crime from an offence perspective, why it occurs, where and how, with reference to the landuse aspect. The analysis was based on an initial review of the seasonal impact on crime, through a temporal dimension. The results show that Malta experiences high summer rates of crime by month, which is subsequently offset by winter incidences where specific weekend to weekday differences are highlighted. The winter months register the most crimes in total as well as being the most favourite for non-serious crimes as against a serious crime situation that is not dependent on seasons. Winter also experiences the greatest differences between weekend as against weekday offences, with the recreational localities being the primary targets. This situation is reinforced by an hourly analysis that shows that most night offences occur in these areas, comprised of serious and vehicle-related offences. These findings confirm Wikstrom's (1990) assertion that that inner-urban activities fluctuate over time and space and that there are different activities experienced at different times of the day, in turn resulting in different types of offences being committed. In addition, an hourly analysis shows that most night offences are comprised of serious and vehicle-related offences reflecting Cohen and Felson's (1979) issue on convergence, Giddens' concept of locale (1984) and Wikstrom's (1990) day-time functional activities.

Spatial analysis resulted in offences being concentrated in a relatively small area of the Maltese islands, within the conurbation with unique hotspots in fringe localities that are mainly recreational in nature both seasonally and hourly. Also offence locations are slowly migrating towards the southern areas of the conurbation. The industrial areas do not form part of the cores, those being taken up by social and community facilities, in effect not conforming to the Chicagoan model, again showing variation in line with Morris's (1957), Baldwin and Bottoms's (1976) and Harries *et al's* (1998), studies.

An area designation analysis shows that the Maltese islands experience a predominantly urban-related crime scenario, except for such categories as drug offences, which are more evident in rural areas. On the other hand, coastal areas register highly in retail-related offences, whilst low on other offence categories. With respect to the historical village cores and the medieval cities, these exhibit lower offence rates though for such offences as assaults and drugs, the latter are relatively high, indicating a specificity for crime by urban-rural distinction. Such a specificity is underscored by Dunn (1980) is his assertion that each different target reflects the area function or structure.

An analysis of land use categories identified that whilst residential areas host the highest offence counts, they also serve as spill-overs from neighbouring activities such as retail. Interestingly, residential areas have a high serious-crime component. The more dynamic recreational activity plays host to high volumes of crime, which occur in concentrated areas, where offences are mainly property-related.

However, a deeper analysis shows that offences in the recreational areas are related to distance in that the category of crime depends on the distance traveled from the retail entity. A cluster analysis shows that there is a relationship between offences and retail. The analysis also showed that San Giljan, particularly its Paceville sub-locality keeps hitting the top mention in all the offence analysis categories.

#### 10.2.5 The technical scenario

This study has reviewed crime analysis through the use of high-end information systems, using both non-spatial and spatial statistics as its base. The advent of GIS and such tools as theme-specific spatio-statistical software has enabled researchers to investigate crime in totally new modes and eliciting new knowledge which was previously difficult to



discern. However, the statistical methods employed need to be further investigated to ensure that they deliver comparative results across the different spatial scales (aggregates) used. With newer and highly sophisticated tools on the horizon, the potential of offender-offence hotspots being mapped in the future is highly sought, particularly since they can bridge the gap between the techno-centric and socio-technic approaches resulting in more emphasis on the results of the latter as against a focus on the creation of ‘nice’ maps that indicate concentrations of incidences. In addition, the future of offender-offence hotspot analysis further stands to gain as more point-level data is made available eliciting higher-level analysis and eliminating the problems emanating from the use of areal boundaries that are not necessarily related to crime. Once this is available for the required datasets, then building up to the diverse aggregated scales would be possible. This would also enable cross-thematic and cross-discipline analysis as conceptualised in the CRISOLA model.

### **10.3 Implications of the study on policy making and crime prevention**

This section of the study discusses the implications of the research on policy making and crime prevention.

The section reviews those highlights from the study that have a direct link on policy making as well as posits issues for crime prevention. This is done through a review of the highlights based on tactical, operational and strategic approaches to tackle crime.

- **Tactical approach**

- a) The main tactical approach requirement as identified in the offence chapter (Chapter 8), refers to the large number of offences in the area of Paceville, over the weekend and at specific times of the day/night periods. Direct implications of such an occurrence revolve around the need for on-street intervention and presence that moves away from mobile-car surveillance to on-the-beat security personnel presence. Such a move requires the provision of real-time data availability to officers to ensure that they have an overview of the activities in question and apprehend offenders as well as have direct access to information on reported crimes requiring direct intervention.
- b) The next tactical requirement centres on the need for a public-private partnership particularly in those areas that have a high-concentration/small-

time-period tactical window. The police force capacity may not be enough to cater for the high number of crimes in the indicated areas and intervention can be provided by public-private security services that ensures synergy and results.

- c) The other tactical issues that policy makers need to review concerns the not-so-successful neighbourhood watch programme in a number of towns in Malta, which system has been virtually abandoned and which needs to be implemented as a proactive way to prevent crime rather than to serve as a reactive service. Together with the previous two tactical measures, the levels of crime can be contained should the effective preventive measures be backed up through operational and strategic approaches.

- **Operational approach**

- a) The most pressing operational requirement in Malta refers to that which concentrates on the need to have realistic figures of crime. This could be carried out through a research based on the Dark Figure of Crime, which survey would enable policy makers and decision-makers to have a base on which to draft policies, enact changes to legislation and instigate change.
- b) Redistricting is one of the main requirements emanating from this study. This is due to the fact that offence hotspots are highly concentrated in small areas that have nothing to do with the areal spatial units set-up by the police administration. The current districting levels do not overlap with the relative concentrations of offences against space and time. Such needs to be studied in depth and ensure that administrative changes reflect the offences' dynamism rather than a monolithic administrative structure.
  - a. Redistricting is also related to the times when capacity is utilised to its full potential, concentrating on seasonal, monthly and weekend to weekday differences in requirements as against the place and time of day offences occur in.
  - b. Redistricting policies should also focus on the fact that Malta's offences are concentrated in a relatively small area of the Maltese islands, within the conurbation with unique hotspots in fringe localities which locations are slowly migrating towards the southern areas of the conurbation.

- c) The operational level cannot claim success without wider-intervention by the social partners in conjunction with the security sector. Due to the fact that the highest concentrations of offences occur in the small area of Paceville, which is essentially a commercial industry area, policy makers should implement actions to factor in security and insurance for the immediate area and the surrounding neighbourhoods. The current leaning on the state to provide for such security should be reviewed within a wider remit: that where the industry would pay a share of the expenses to maintain security.
- d) A high-level operational approach is required to ensure that security services are more prevalent in areas that exhibit high dwelling concentrations, low population density areas, high vacant dwelling concentrations and those areas that have been zoned for apartments. This also includes focusing on the Urban Conservation Areas.
- e) Police could take up a new mode of apprehending and investigating suspects mainly due to the finding that Maltese offenders commit crime close to their residence particularly based on a study between distance by crime type. Such can be based on the development of a cognitive map structure for each known offender, highly reducing the time taken to target an offender prior to carrying out more direct intervention and apprehension methods.

- **Strategic approach**

**Social Policy**

- a) Policy makers can now review the outcomes of decades-long mixed social-engineering efforts either through:
  - a. direct intervention in the housing market which created housing estates that served to displace offenders
  - b. or through their recent non-intervention in the housing market, which situation has resulted in a veritable broken windows situation in some towns and in the urban cores.
- b) Policy changes are required at national level to instigate change in the areas that have been identified as being offender-hotspot localities and have high-levels of clustering of offenders, mainly the cities of Bormla and Valletta which towns have a disproportionate offender concentration when compared to their shrinking population concentration.
- c) The social planners must also initiate policy measures in those areas that have been identified as having highly clustered offenders, implementing measures to reduce

poverty, increase social cohesion and social capital. This would help alleviate the problems related to the tendency for offenders to aggregate and live in poor areas.

- d) Planners also need to be aware of the fact that areas of high population density would also relate to high levels of offender density, particularly in the inelastic walled cities.
- e) Educators and criminologists must concentrate their efforts to identify and monitor those juveniles who have already clashed with the judicial and police systems in order to reduce the probability of the establishment of a criminal career. The implications here are varied since the need for synergies between the educational, corrective and welfare systems are required, together with the provision of highly skilled early-intervention personnel. This can be followed up for those aged up to 30 to initiate self-employment strategies in order to overcome the issue of non-employability.
- f) Policy makers should ensure that access to data and information is made available to the entities involved in security to ensure timely action and implementation of enforcement actions which are still in need of upgrading and lack ownership by the authorities.

### **Sentencing and Release Policy**

- a) One of the direct consequences of the current sentencing and release policies refers to recidivism, where highly-active offenders are released over-and-over and who reoffend and are incarcerated again. There must be an evaluation of early release as well as a realistic debate on the introduction of parole, together with a sentencing practice that fits the seriousness of the offence committed.

### **International Issues**

- a) At an international level, Malta must strive to reduce its relative incidence of crime in order to re-instate the islands on the extreme safety-end of the relative safety-dangerousness scale depicted in Chapter 7. This is due to the progressive decrease in relative safety when compared to other countries.
- b) International offenders, amounting to so high a proportion in Malta, may imply the requirement for multi-lateral and bi-lateral agreements for deportation and continuation of sentence in the prisoners' country of origin. This would reduce the economic strain and space issues faced by the Maltese correctional facilities.

## 10.4 Points for further study

The final section of this study lists a series of recommendations for further study.

This section posits a list of items that have been identified within the course of the study as being of high importance and that they elicit the need for further investigation. This list includes the main research questions identified in Chapter 3 that could not be analysed and those research topics identified in the course of the study,

1. **Conceptual Model:** A further development of the conceptual model will entail the Phase 3 dataset development and measures structure. Each of the variables, sectors and linkages needs to be reviewed in line with established methodologies to enable the creation of a full CRISOLA model being refined.

The model is not exhaustive as it covers potential datasets that yet need to be created/surveyed, statistical measures identified as well as inclusion of other crime-relevant theories. The model can be evolved in future studies as it attempts to highlight areas of study not tackled in this research and which may/may not be found to be significant, entailing further change.

The deeper one moves into the model (towards the bottom part of each section and where the predictors are highlighted) the more research is needed to identify the real relationships and how each parameter can be predicted. The model does not attempt to solve these issues in this study but depicts the potential future studies that can be attempted.

2. **Population Density and gender:** Further study is needed in this area especially on population density and the relationship to crime. This is particularly due to the fact that areas with a high population density offer a higher concentration of crime opportunities and effectively higher potential crime targets (people and property). In the case of gender, a study is recommended to analyse how far changes in the male population results in more/fewer crimes.

3. **Education - absenteeism and drop-outs:** Further research is required to analyse if high school dropout rates may lead to more time to engage in criminal activities as well as their potential effect on criminal careers.

4. **Seriousness:** Further research is required to analyse whether there is a relationship between the seriousness score and the relative sentencing practice, across time and in different countries. A weighting method for Malta and other EU and Islands level should be created.

6. **Poverty and drugs:** Further study is required to analyse whether there is a relationship between poverty and drug use and in turn crime. Poverty Watch's assertion that imprisonment often led to drug trafficking is one such issue.

7. **Transport:** Future studies can analyse crime in Malta based on transport patterns by time as identified in the Household Travel Survey. The latter can be used to analyse whether crime patterns in Malta follow the relationship between this mobility issue and settlement patterns. Other studies could analyse whether there is a relationship between transport and crime levels – main transport corridors have a high rate of crime relative to the adjacent areas. In the case of public transport an analysis is recommended which would explore whether certain bus transport corridors have high rates of specific crime types, and how far can identify and measure crime change along transport corridors (bus stops and bus routes corridors).

8. **Remission and amnesties:** A future study should analyse whether re-offending is committed by persons awarded remission or an amnesty within the period when the full sentence should have been operative.

9. **Crime increase:** Future study is recommended to review the incidence of large increases in crime reporting over the decades in order to elicit linkages such as economic improvement, and more efficient policing systems.

10. **Convictions:** Future studies are needed to explain increases in the number of convictions in the 1990s that take into account the introduction of new legislation, a more efficient sentencing system, an increasing crime rate and police/court closure of cases.

11. **Journey to crime:** Future study on journey to crime is required by locality, type of offence, time and day. Such an analysis would help in the identification of potential offender territories, mode of transport, type of target, and if there is a correlation between movements from residence to workplace. Journey to crime analysis in Gozo also requires further analysis to elicit particularities, if any, in the Gozitan offence as targeted by Gozitan offenders, cases in point being Nadur, Sannat and Xaghra, the lowest in the matrix.

12. **Offender residence and poverty:** Future studies show enable the creation of a full index of deprivation for the Maltese Islands enabling the understanding of poverty and deprivation in

Malta, which would lay the ground for further analysis in the relationship between offender residence and poverty.

13. **Vacant and deteriorated buildings:** Future studies on vacant dwellings in Malta would help analyse whether there is a relationship between offences, vacant stock and state of the stock.

14. **Offences and dwellings type:** Future study is required to analyse offences by type as against the type of dwelling unit or other zoning category they occur in.

15. **Migration:** Future study is required to analyse why offenders choose to live in the locations they do: Where they migrate to after incarceration, when it occurs, is also a case for study.

16. **Seasons and tourism:** Future studies are required to gauge the effect of tourism on crime and vice-versa. This would help elicit the impact of crimes committed on and by tourists as well as the relative offence densities based on the two population components: local and tourist. A study of crime rates during the summer weekend nights as against their winter counterparts and the targets/victims is highlighted.

17. **Climate:** A study on the role climate plays in crime in the Maltese islands is recommended, principally should there be a relationship between offences such as threats and bodily harm in relation to climatological issues such as high temperatures, humidity, daylight hours and high pressure systems, particularly in the summer months?

18. **Retail:** Future studies are required to gauge the impact of retail and recreation on crime, particularly very serious crimes that occur in leisure and recreation areas which are effective places of crowding.

19. **Landuse development:** Future studies are required to analyse whether there is an impact of development permits on crime, in particular, the extent to which development permits cause crime to increase. Also a study is necessary on who commits development offences them and their relationship to other types of offence.

20. **Analysis Techniques:** Future studies should take into account the potential analysis techniques that will further the results of this research, amongst them moving from uni-variate and bi-variate to multi-variate analysis. This was not possible to carry out during this study since the main thrust was to establish the first crime-maps for Malta through the process described in Chapter 6, and carry out uni-variate and bi-variate analysis for

the different offender-offence requirements, which helped establish an understanding of some of the variables under study. However, the aim to go for multi-variate analysis was hampered by pressure on research delivery mainly due to time and space constraints. This said, such potential analysis techniques include multiple regression or multi-variant analysis, as well as other hotspot analysis techniques than those used in this study such as Kernel Density Estimate (KDE) and the Getis-Ord GI\* statistic.

## **10.5 Conclusion**

In conclusion, this research identified the main offender and offence structures for the Maltese islands and analyses these facets in relation to the social and landuse structures. The results show an offender and offence dynamism that reflects a changing crime structure across space and time. The models and applications created within this project serve a multiple purpose both for this study and for further research, with the main emphasis being placed on the conceptual model, the safety-dangerousness scale and Maltese Crime Web-Map. The other analytical process as described within the text vouch for the need to continue researching this topic to elicit more detailed studies aimed at carrying out trend analysis.



## Bibliography

- Abela A.M., (1992), *Transmitting Values in European Malta. A Study in the Contemporary Values of Modern Society*. Valletta and Rome: Jesuit Publications/Editrice Pontificia Universita Gregoriana
- Abela M., (accessed on 4th April 2006), *Delitt Orribli Ta' Omm Li Qatghet Ras Binha, li grat fit-23 ta' Awissu 1960* - <http://www.allmalta.com/ghana/fatti20.html>
- Acevedo W., and Masuoka P., (1997), *Time-series animation techniques for visualizing urban growth*. Computers and Geosciences, Vol. 23 No. 4, pp 423-435
- Albuquerque de K. and McElroy J., (1999), *Tourism and crime in the Caribbean*. Annals of Tourism Research, Vol. 26 No. 4, pp 968-984
- Alvazzi del Frate, A. And Van Kesteren, J.N., (2004), *Criminal Victimization in Urban Europe. Key findings of the 2000 International Crime Victims Survey*. Turin, UNICRI
- Anderson E., (1990), *Streetwise: Race, Class and Change in an Urban Community*: University of Chicago Press
- Appleyard D. and Lintell M., (1972), *The Environmental Quality of City Streets: The Resident's Viewpoint*. Journal of the American Institute of Planners 38:84-101
- Appleyard D., (1981), *Livable Street: Protected Neighbourhoods*. Berkeley, CA, University of California Press
- Applied Criminology Group, (July 2001), *Kirklees Crime and Disorder Audit - Final Report*. University of Huddersfield
- Attard E., (2000), *Il-Habs: L-Istorja tal-Habsijiet f'Malta mill-1800*. Palprint Press, Bir id-Deheb, Malta, ISBN 99932-0-045-x
- Bair S., (2002), *Investigative Analysis*, IN *Advances crime mapping techniques, Results of the First Invitational Advanced Crime Mapping Topics Symposium*. June 2001, Denver Colorado, CMAP
- Baldwin J. and Bottoms A.E., (1976), *The Urban Criminal*, Tavistock, London
- Barak G., (Editor), (2000), *Crime and Crime Control: A Global View*. Greenwood Press, Westport, CT, USA, ISBN 0-313-30681-8
- Bartolo G., (9th April 2000), *Home Alone 3 A child's right to schooling*. The Malta Independent on Sunday, Standard Publications 1999
- Baud-Bovy M. & Lawson F., (1998), *Tourism and Recreation: Handbook of Planning and Design*. Architectural Press, Oxford
- Baumer, E. (1997), *Levels and Predictors of Recidivism: The Malta Experience*. Criminology 35:601-628
- Bean P., (1976), *Rehabilitation and Deviance*. Routledge & Kegan Paul, London, ISBN 0-7100-8271-1
- Beavon D.J.K, Brantingham P.L., and Brantingham P.J., (1994), *The Influence of Street*

- Networks on the Patterning of Property Offenses*, IN Clarke R.V., (ed) *Crime Prevention Studies*. Vol. 2. Monsey, NY: Criminal Justice Press
- Bell A., (1994), *The delinquent youth: a sociological study of juvenile delinquency in Malta*. unpublished MA thesis, University of Malta
- Bennett R., (1991), *Development and Crime: a Cross-National, Time-Series Analysis of Competing Models*. *Sociological Quarterly*, 32 (fall), 343-363
- Bevis C. and Nutter J.B., (1977), *Changing Street Layouts to Reduce Residential Burglary*. Paper presented at the Annual Meeting of the American Society of Criminology, Atlanta, GA (cf. Beavon et al, 1994)
- Blackledge D., and Hunt B., (1989), *Sociological Interpretations of Education*. Routledge, London, ISBN 0-415-04285-2
- Boggs S.L., (1965), *Urban Crime Patterns*. *American Sociological Review* 30:899-908
- Boissevain J., (1965), *Saints and Fireworks: Religion and Politics in Rural Malta*. London School of Economics Monographs on Social Anthropology No. 30
- Boissevain J., (1980), *A Village In Malta: Fieldwork Edition*. Holt, Rinehart & Winston, Inc, New York, ISBN 0-03-053411-9
- Borg J., and Azzopardi J., (22 October 1993), *Kif tista' omm toqtol lil binha? – Giga*, Il-Gens
- Bottomley K., and Pease K., (1986), *Crime and Punishment: Interpreting the data*. Open University Press, Milton Keynes, England, ISBN 0 335 15389 5
- Bottoms A.E. and Wiles P., (1986), *Housing Tenure and Residential Community Crime carriers in Britain*, IN Reiss A.J. and Tonry M. (eds.), *Communities and Crime*. University of Chicago Press, Chicago, Ill
- Bottoms A.E. and Wiles P., (1997), *Environmental Criminology*, IN Maguire M., Morgan R. and Reiner R., (1997), *The Oxford Handbook of Criminology*. Oxford University Press, Oxford
- Bottoms A.E., and Wiles P.W., (2001), *Explanations of Crime and Space*, IN Evans D.J., Fyfe N.R., and Herbert D.T., (2001), *Crime, Policing and Place: Essays in Environmental Criminology*. Routledge, London, ISBN 0-415-04990-3
- Bottoms A.E., Mawby R.I. and Xanthos P., (1989), *A Tale of Two Estates* IN Downes D., (ed), *Crime and the City*, Macmillan Press, London
- Bottoms, A.E., Claytor, A and Wiles, P. (1992) *Housing markets and residential community crime careers: A case study from Sheffield*. In Evans, D.J., Fyfe, N.R. and Herbert, D.T. (eds) *Crime, policing and place: Essays in environmental criminology*. London: Routledge.
- Brace N., Kemp R. and Snelgar R., (2000), *SPSS for Psychologists – A Guide to Data Analysis using SPSS for Windows*. Palgrave, MacMillan Press Limited, London, ISBN 0-333-73471-8
- Braithwaite J., (1989), *Crime, Shame and Reintegration*. Cambridge: Cambridge University Press (cf Bottoms and Wiles IN Evans et al, 2001)
- Brantingham P.J. and Brantingham P.L., (1984), *Patterns in Crime*. New York, Macmillan
- Brantingham P.J. and Brantingham P.L., (eds), (1981), *Environmental Criminology, Prospect*

heights. IL, Waveland Press

Brantingham P.L. and Brantingham P.J., (1981), *Notes on the Geometry of Crime*, IN Brantingham P.L. and Brantingham P.J. (eds), *Environmental Criminology*. Sage Publications, Beverly Hills, California

Brantingham P.L. and Brantingham P.J., (1994), *The Relative Spatial Concentration on Criminality and its Analysis: Toward a Revival of Environmental Criminology*. *Criminologie*, 27 (1), 81-97

Bromley R., and Thomas C., (April 1997), *Vehicle crime in the city centre: Planning for secure parking*. *Town Planning Review*, Vol. 68, 2, 257-278

Bruce C.W., (2002), *Killing Crime at its Root*, IN *Advances crime mapping techniques, Results of the First Invitational Advanced Crime Mapping Topics Symposium*. June 2001, Denver Colorado, CMAP

Bryman A and Cramer D., (1994), *Quantitative Data Analysis for Social Scientists*. (Revised Edition), Routledge, London, ISBN 0-415-113075

Buchanan C. and partners, (August 1990), *Structure Plan Report of Survey Vol. 1, Report for the Malta Planning Authority*, published by the PA

Buhagiar A., (2000), *Disposal Rates in the Maltese Courts during the years 1979-1998*, IN Vella C.C., (2000), *The Maltese Islands on the Move*. Central Office of Statistics, Valletta, Malta

Bursik R.J., (1986), *Ecological Stability and the Dynamics of Delinquency*, IN Reiss A.J., and Tonry M., (eds.), *Communities and Crime: Crime and Justice, A Review of Research*, Volume 8. Chicago: University of Chicago Press

Bursik R.J. and Grasmick H.G., (1993), *Neighbourhoods and Crime*. Lexington Press, New York

Cairns S., (1998), *Promises and Problems: using GIS to analyse shopping travel*. *Journal of Transport Geography*, Vol. 6 No. 4, pp. 273-284

Calleja C., (Thursday 28th September 2006), *Khat plant contains scheduled drugs – expert*. *Times of Malta*. - <http://www.timesofmalta.com/core/article.php?id=238299&hilite=khat>

Calleja L., (1994), *Attempted crime: a comparative study*. unpublished LLD thesis, University of Malta

Camilleri A., (2000), *A plea for bi-partisan consensus*, IN *BICC Housing Affordability in Malta*. San Gwann: Publishers Enterprises Group (PEG)

Campbell B., (1993), *Goliath: Britain's Dangerous Places*. Methuen, Press

Carlstein T., (1980), *Time, Resources and Ecology*. Lund: Department of Geography

Caso A., (ed), (1992), *An Essay on Crimes and Punishments by Cesare Beccaria* (4<sup>th</sup> Edition), International Pocket Library, Boston, ISBN 0-8283-1800-x

Cauchi L., (2001), (accessed on May 2005), *Historical Development of Policing in Malta*. German-Maltese Circle Newsletter No.8/2001 - <http://www.germanmaltesecircle.org/Malta%20Police.doc>

Central Office of Statistics, Malta, (1986-1999), *Abstract of Statistics 1986 to 1999*. Malta: Government Press.

Chainey S., (January/February 2004), *GIS and crime mapping – going beyond the pretty hotspot map*,. *Geomatics World*, 24-25

Chermak S., (December 1997), *The presentation of drugs in the news media: the news sources involved in the construction of social problems*. *Justice Quarterly*, Vol. 14 No. 4, 687-718

Clark M., (1999), *The pursuit of a criminal career among Maltese male youth: a biographical approach*. unpublished PhD dissertation, University of Sheffield

Clarke K., (1995), *Analytical and Computer Cartography*. Prentice Hall, Englewood Cliffs, N.J.

Clarke R. and Felson M., (eds.), (1993), *Routine Activity and Rational choice*, New Brunswick, Transaction

CMAP, (June 2003), *Advances crime mapping techniques, Results of the First Invitational Advanced Crime Mapping Topics Symposium*. June 2001, Denver Colorado - <http://www.nlectc.org/cmap/>

Cohen L.E. and Felson M., (1979), *Social Change and Crime Rate Trends: A Routine Activities Approach*, *American Sociological Review*, 44: 588-608

Cohen L., & Holliday M., (1982), *Statistics for Social Scientists*. London: Harper & Row  
Cohen S., (1992), *Against Criminology*. Transaction Publishers, New Jersey, USA, ISBN 0-88738-689-x

Coleman J.S., (1990), *The Foundations of Social Theory*. Harvard University Press, Cambridge, MA,

Coolican H., (1990), *Research Methods and Statistics in Psychology*. Hodder & Stoughton, Sevenoaks, Great Britain, ISBN 0-340-52404-9

Corradino Correctional Facility, (2000), *Information to Inmates*. Paola, Malta

Corradino Correctional Facility, (1979), *Il-Habs u L-Habsin*. Paola, Malta

Craglia M., Haining R., and Wiles P., (April 2000), *A Comparative Evaluation of Approaches to Urban Crime Pattern Analysis*, *Urban Studies*. Vol. 37, No. 4, 711-729, 2000, University of Glasgow

Craglia, M., Haining R. and Signoretta P. (2001), *Modeling High-intensity Crime Areas in English Cities*, In: *Urban Studies*. 38(11), 1921-1942.

Cremona R., (1999), *Crime caused as a consequence of the Second World War in Malta*. unpublished BA thesis, University of Malta

Crime Prevention UK, (accessed 25 February 2004 – <http://www.crimereduction.gov.uk/cpindex.htm>

Dantzker M.L. and Hunter R.D., (2000), *Research Methods for Criminology and Criminal Justice: A Primer*. Butterworth Heinemann, Woburn, MA, USA, ISBN 0-7506-9951-5

- Dear M., and Flusty S., (1998), *Postmodern Urbanism*, *Annals of the Association of American Geographers*. 88, 1, pp 50-72
- DeJong C., and Jackson K.C., (1998), *Putting race into context: race, juvenile justice processing and urbanization*. *Justice Quarterly*, Vol. 15 No. 3, 487-504
- DETR, (1998), *1998 Index of Deprivation: a summary of results*. DETR, 1998
- Doeian, P. (1980), *Linear Models with Spatially Distributed Data: Spatial Disturbances or Spatial Effects?* *Sociological Methods and Research*, 9(1), 29-60
- Doyle R., (November 2005), *Fewer men, more crime: how a falling sex ratio can undermine a community*. *Scientific American*, Vol. 293,5:18
- Dunn C.S., (1980), *Crime Area Research*, IN Georges-Abeyie D.E., and Harries K.D., (eds), (1980), *Crime: A Spatial Perspective*. Columbia University Press, New York
- Durkheim E., (1933), (accessed Jan 2006), (translated by George Simpson), *The Division of Labour in Society*. The Free Press, New York - <http://durkheim.itgo.com/crime.html>
- Einstadter W. and Henry S., (1995), *Criminological Theory: An Analysis of Its Underlying Assumptions*. Harcourt Brace College Publishers, Texas, ISBN 0-15-500329-1
- Eitzen D.S. and Zinn M.B., (1988), *In Conflict and Order: Understanding Society* (4<sup>th</sup> Edition), Allyn and Bacon Inc, Massachusetts, ISBN 0-205-11267-6
- Eklblom P., (2001), *The Conjunction of Criminal Opportunity: A framework for crime reduction toolkits*, Policing and Reducing Crime Unit Research, Development and Statistics Directorate Home Office
- Ellaway A., and Macintyre S., (1998), *Does housing tenure predict health in the UK because it exposes people to different levels of housing related hazards in the home or its surroundings?* *Health and Place*, Vol. 4 No. 2, pp 141-150
- Elliott C., and Ellingworth D., (1996), *The relationship between unemployment and crime: a cross-sectional analysis employing the British Crime Survey 1992*. *International Journal of Manpower*, Vol. 17 No. 6/7, pp 81-88
- Ellul S., (2003), *Housing in Vittoriosa: A Holistic Approach*. unpublished MA Geography dissertation, University of Malta
- Entorf H., and Spengler H., (2000), *Socio-economic and demographic factors of crime in Germany: Evidence from Panel Data of the German States*. *International Review of Law and Economics* 20 (2000), 75-106
- Europol, (accessed 25 February 2004) - <http://www.europol.eu.int/>
- Evans D.J., Fyfe Nicholas R.F., Herbert D.T., (2001), *Crime, Policing and Place, Essays in Environmental Criminology*. Routledge, London, ISBN 0-415-04990-3
- Evans T.D., Cullen F.T., Dunaway R.G., and Burton Jr. V.S., (1995), *Religion and crime re-examined: the impact of religion, secular controls and social ecology on adult criminality*. *Criminology*, Col. 33 No. 2, 195-219
- Farrall S, Bannister J., Ditton J., and Gilchrist, (2000), *Social Psychology and the Fear of Crime: Re-Examining a Speculative Model*, *Brit. J. Criminol.*, 40, 399-413

- Farrington, D.P., (1986), *Age and Crime*. Crime and Justice 7:189-250
- Farrington, D.P., (1987), *Epidemiology*, IN H.C. Quay (ed), *Handbook of Juvenile Delinquency*. New York: Wiley.
- Faust K, Entwisle B., Rindfuss R.R., Walsh S.J., and Sawangdee Y., (1999), *Spatial arrangement of social and economic networks among villages in Nang Rong District*. Thailand, Social Networks, 21, 311-337
- Felson M. and Clarke R.V., (1998), *Opportunity Makes the Thief: Practical theory for crime prevention*, Police Research Series, Paper 98, Home Office Policing and Reducing Crime Unit Research, Development and Statistics Directorate, ISBN 1-84082-159-0
- Finestone H., (1976), *Victims of Change*. Westport, CT: Greenwood
- Formosa Pace J., (2003), *Juveniles in Jeopardy: A Maltese Case Study*. unpublished MSc Forensic & Legal Psychology, thesis, University of Leicester
- Formosa S., (1996), Water Services Data, (1995, 1996, 1998 data) Metering data used for the analysis of population structure by street, migration, dwelling stock and dwelling usage, Water Services Corporation, Malta. Study was carried out in 1996 by Saviour Formosa at MEPA for analysis of population and dwelling statistics at mid-Census term
- Formosa S., (2000), *Coming of Age: Investigating The Conception of a Census Web-Mapping Service for the Maltese Islands*. unpublished MSc thesis Geographical Information Systems, University of Huddersfield, United Kingdom - <http://www.mepa.org.mt/Census/index.htm>
- Fotheringham A.S., (1999), Trends in quantitative methods III: stressing the visual, Progress in Human Geography, 23, 4, 597-606
- Fritz N., (2002), *The Growth of a Profession: A research means to a public safety end*, IN *Advances crime mapping techniques, Results of the First Invitational Advanced Crime Mapping Topics Symposium*. June 2001, Denver Colorado, CMAP
- Galle O.R., Gove W.R., and Miller McPherson J., (1972), *Population Density and Pathology: What are the Relations for Man?* Science, 176, 1972
- Galvão Carneiro F., Loureiro P.R.A. and Sachsida A., (2005), Crime and social interactions: a developing country case study. Journal of Socio-Economics, Volume 34, Issue 3 , May 2005, Pages 311-318
- Georges-Abeyie D.E., and Harries K.D., (eds), (1980), *Crime: A Spatial Perspective*. Columbia University Press, New York
- Giddens A., (1984), *The Constitution of Society: Outline of the Theory of Structuration*. Polity Press, Cambridge: ISBN 0-7456-0007-7pb
- Gill, O. (1977), *Luke Street, Housing Policy, Conflict and The Social Creation of a Delinquent Area*. London: Macmillan
- Giora Shoham S. and Hoffman J., (1991), *A Primer in the Sociology of Crime*. Willow Tree Press
- Gold M. and Osgood D.W., (1992), *Personality and Peer Influence in Juvenile Corrections*. Greenwood Press, Westport, CT, - ISBN 0-313-27970-5

- Goldfield D.R. and Brownell B.A., (1979), *Urban America: From Downtown To No Town*, Boston, Houghton Mifflin
- Gottfredson M.R. and Hirschi T., (1990), *Social Relations and Spatial Structures*, London, MacMillan (cf Bottoms and Wiles, 2001 IN *Evans et al 2001*)
- Government of Malta, (2001), *Chapter 440 Data Protection Act, ACT XXVI of 2001*. Valletta, Malta
- Greenwood, Peter W. 1982. *Selective Incapacitation*. Santa Monica, CA: Rand Corporation.
- Gregory D. and Urry J., (1985), *Social Relations and Spatial Structures*. London Macmillan, (cf Bottoms and Wiles IN *Evans et al, 2001: 11*)
- Grosselfinger N., (1994), (accessed on May 2005), World Factbook of Criminal Justice Systems. University of Malta - <http://www.ojp.usdoj.gov/bjs/pub/ascii/wfbcjmal.txt>
- Hagan J., (1987), *Modern Criminology – Crime, Criminal Behaviour and its Control*. McGraw-Hill International Editions, Sociology Series, Singapore, ISBN 0-07-100468-8
- Hagan J., (1994), *Crime and Disrepute*. Pine Forge Press, Thousand Oaks, Cal.
- Hagerstrand T., (1975), *Space, time and human conditions*, IN Karlqvist A., *Dynamic Allocation of Urban Space*. Farnborough: Saxon House
- Haining R., (1987), *Spatial Modelling and the Statistical Analysis of Spatial Data in Human Geography*. *Mathematiques et Sciences Humaines*, 25(Fall), 5-25
- Haining R., (1990), *Spatial Data Analysis in the Social and Environmental Sciences*. Cambridge University Press, New York
- Ham R.C., (1986), *Timing and Spacing of Crime in the Urban Environment: Lexington-Fayette County, Kentucky*, Dissertation Abstracts International, The Humanities and Social Sciences, 47(4). Dissertation
- Hansel M., (1987), Citizen Crime Stereotypes – normative consensus revisited, *Crim* 25, 455-485
- Harries K., (1976), *Cities and Crime: A Geographical Model*. *Criminology*. 14, 369-386
- Harries K.D., (1974), *The Geography of Crime and Justice*. McGraw-Hill Book Company, New York
- Harries K.D., (1981), Alternative Denominators in Conventional Crime Rates, IN Brantingham P.J. and Brantingham P.L., (eds), (1981), *Environmental Criminology, Prospect heights*. IL, Waveland Press
- Harris K., (1995), *The last walk: a geography of execution in the United States, 1786-1985*. *Political Geography*, Vol. 14 No. 5, pp 473-495
- Harries R., and Lewis R., (1998), *Constructing a Fault(y) Zone: Misrepresentations of American Cities and Suburbs. 1900-1950*. *Annals of the Association of American Geographers*, 88(4), pp 622-639, Blackwell Publishers, Malden, MA
- Heal K., (2001), *Changing Perspectives on Crime Prevention: the role of information and*

- structure, IN Evans D.J., Fyfe N.R., and Herbert D.T., (2001), *Crime, Policing and Place: Essays in Environmental Criminology*. Routledge, London, ISBN 0-415-04990-3
- Helms D., (2002), *The Tactical Checklist: A general Methodology for Analytical Investigation*, IN *Advances crime mapping techniques, Results of the First Invitational Advanced Crime Mapping Topics Symposium*. June 2001, Denver Colorado, CMAP
- Hembroff L.A., (1987), Seriousness of Acts and Social Contexts: a test of Black's theory of behaviour of law, *Am J Soc* 93, 322-347
- Henry S., and Lanier M., (1998), *The prism of crime: arguments for an integrated definition of crime*. *Justice Quarterly*, 15 (4), pp. 609-27
- Henry S., and Milovanovic D., (1996), *Constitutive Criminology: Beyond Postmodernism*. Sage, London cf, IN McLaughlin E. and Muncie J., (eds), (2001), *The Sage Dictionary of Criminology*. Sage Publications, London
- Herbert S., (1999), *The end of the territorially-sovereign state? The case of crime control in the United States*. *Political Geography*, 18, 149-172
- Herzog T.R., (1996), *Research Methods and Data Analysis in the Social Sciences*. Addison Wesley Longman, Inc.
- Herzog T.R., and Chernick K.K., (2000), *Tranquility and Danger in Urban and Natural Settings*. *Journal of Environmental Psychology*, 20, 29-39
- Hester S. and Eglin P., (1993), *A Sociology of Crime*, Routledge, New York
- Hirschfield A., (2001), *Decision Support in Crime Prevention*, IN Hirschfield A., and Bowers K., (eds), (2001), *Mapping and Analysing Crime Data: Lessons from Research and Practice*. Taylor & Francis, London, ISBN: 0-748-40922-X
- Hirschfield A., and Bowers K., (eds), (2001), *Mapping and Analysing Crime Data: Lessons from Research and Practice*. Taylor & Francis, London, ISBN: 0-748-40922-X
- Hirschfield A., and Bowers K.J., (1997), *The effect of social cohesion on levels of recorded crime in disadvantaged areas*. *Urban Studies*, Vol. 34, No. 8, 1275-1295
- Hirschfield A., Yarwood D and Bowers K., (1997), *Crime Pattern Analysis, Spatial Targeting and GIS: the Development of New Approaches for Use in Evaluating Community Safety Initiatives*, IN *Proceedings of the RRL-net-SCGISA Workshop on GIS for Crime and Health Data Analysis*. Sheffield, 25-26 May 1997, Sheffield: SCGISA, (cf Craglia M., Haining R., and Wiles P., (April 2000), *A Comparative Evaluation of Approaches to Urban Crime Pattern Analysis*, *Urban Studies*. Vol. 37, No. 4, 711-729, 2000, University of Glasgow)
- Hirst P., (2000), *Statism, Pluralism and Social Control*. *Brit. J. Criminol*, 40, 279-295
- Hochstetler A., Copes H. and DeLisi M., (2002), *Differential association in group and solo offending*. *Journal of Criminal Justice*, Volume 30, Issue 6, November-December 2002, Pages 559-566
- Hollin C., (1992), *Criminal Behaviour*. Falmer Press, - ISBN 0-415-07370-7
- Holmes R.M. and Holmes S.T., (1996), *Profiling Violent Crimes: An Investigative Tool* (2<sup>nd</sup> Edition), Sage Publications Ltd., California, ISBN 0-8039-7239-3



- Home Office (accessed 25 February 2004), UK - <http://www.homeoffice.gov.uk/>
- Home Office Research, Development and Statistics Directorate (2002, December 24), Aspects of Crime: Young Offenders 1999 – <http://www.homeoffice.gov.uk>
- Horst E. and Hannes S., (2004), *European Regional Crime Database*. Darmstadt University of Technology
- Howard D.E., (1996), *Searching for resilience amongst African-American Youth exposed to community violence: Theoretical Issues*. Journal of Adolescent Health, 18, 254-262
- Howard J., (2002), *How to De-Mystify GIS by understanding the role of common-sensed GIS and Blue Collar GIS in Public Safety*, IN *Advances crime mapping techniques, Results of the First Invitational Advanced Crime Mapping Topics Symposium*. June 2001, Denver Colorado, CMAP
- Hoyt H., (1939), *The Structure and Growth of Residential Neighborhoods in American Cities*. Washington, Federal Housing Administration
- Hyatt R.A. and Holzman H.R., (August 1999), *Guidebook for Measuring Crime in Public Housing with Geographic Information Systems*. US Department of Housing and Urban Development, Office of Policy Development and Research, Washington DC, US
- Interpol, (accessed 25 February 2004) - <http://www.interpol.int/>
- Ireland P., (1998), *Helping Police with their enquiries, Mapping Awareness*. 12(3), pp: 21-24
- Jackson J.L. and Bekerian D.A., (1997), *Offender Profiling: Theory, Research and Practice*. John Wiley and Sons, West Sussex, England, ISBN 0-471-97565-6
- Jackson K.T., (1985), *Crabgrass Frontier: The Suburbanisation of the United States*, New York, Oxford University Press
- Jacobs J., (1961), *The Death and Life of Great American Cities*. New York, Random House
- Jansson K., (2007), *British Crime Survey – Measuring Crime for 25 years*, British Crime Survey, Home Office, United Kingdom
- Jennings A., (1992), *From Marx to the Mafia*. New Statesman and Society, 1992:6(14):18-20
- Karlsson T., (1998), *Sharp force homicide in the Stockholm Area, 1983-1992*. Forensic Science International 94 (1998) 129-139
- Katz J., (1988) *Seductions of Crime: Moral and Sensual Aspects of Doing Evil*. New York, Basic Books
- Kawachi I., and Kennedy B.P., (1997) *Health and Social Cohesion: Why Care About Income Inequality?* British Medical Journal, 314, 1037, 1040,
- Kawachi I., Kennedy B.P., and Wilkinson R.G., (1999), *Crime: social disorganisation and relative deprivation*. Social Science and Medicine 48 (1999) 719-731
- Keebler N., (1975), *Recession Leaves Its Mark On Family Structure*, *The National Observer* (March 29):4, cited IN Eitzen D.S. and Zinn M.B., (1988), *In Conflict and Order: Understanding Society* (4<sup>th</sup> Edition), Allyn and Bacon Inc, Massachusetts, ISBN 0-205-11267-6

Kelley A.M., (1967), *London Labour and the London Poor: A Cyclopaedia of the Condition and Earnings of Those That Will Work, Those That Cannot Work, and Those That Will Not Work*. [1861], New York

Knox P.L., (1975), *Social Well-Being: A Spatial Perspective*. Oxford University Press, London, ISBN 0-19-874039-5

Koffman L., (1996), *Crime Surveys and Victims of Crime*. University of Wales Press

Kosbela E., and Viren M., (1997), *An Occupational Choice Model of Crime Switching*. Applied Economics, 29, 655-660

Koster A., (1984), *Prelates and Politicians in Malta: Changing Power-Balances between Church and State in a Mediterranean Island Fortress*. (1800-1976), Van Gorcum & Comp. B.V., Assen, The Netherlands, ISBN 90-232-2063-3

KRA Corporation, (April 1997), *A guide to Evaluating Crime Control of Programs in Public Housing*. US Department of Housing and Urban Development, Office of Policy Development and Research, Rockville, MD, USA

Kurtz E.M., Koons B.A., and Taylor R.B., (March 1998), *Land use, physical deterioration, resident-based control, and calls for service on urban streetblocks*. Justice Quarterly, Vol. 15 No. 1, 121-149

Kwan Y.K., Cheung Ip W., and Kwan P., (2000), *A Crime Index with Thurstone's Scaling of Crime Severity*. Journal of Criminal Justice, 28 (2000) 237-244

Ladanyi J., (2001), *Where Criminals Live: A Study of Budapest*. IN Evans et al 2001

Lambert J.R., (1970), *Crime, Police and Race Relations: A Study in Birmingham*. Oxford University Press, London

Lauri G., (1980), *Aspects of crime and punishment in the early decades of seventeenth century Malta*. unpublished BA thesis, University of Malta

Lea J., and Young J., (2000), *Relative Deprivation*, IN Muncie J., McLaughlin E. and Langan M., (eds), (2000), *Criminological Perspectives: A Reader*. Sage Publications, London

Levantis T., and Gani A., (2000), *Tourism demand and the nuisance of crime*. International Journal of Social Economics, Vol. 27 No. 7/8/9/10, pp 959-967

Levine N.L., (2002), *CrimeStat: A Spatial Statistics Program for the Analysis of Crime Incident Locations (v 2.0)*. Ned Levine & Associates, Houston, TX, and the National Institute of Justice, Washington, DC.

Lilly, J.R., Cullen, F.T. and Ball, R.A., (1995), *Criminal Theory: Context and Consequences*. Sage, Thousand Oaks, CA

Lloyd W., (1995), *Policing – give us the tools and we will do the job: 1992-93 Urban Crime Fund Programme*. International Journal of Project Management, Vol. 13 No. 6, pp 403-405

Lundman R.J., (1993), *Prevention and Control of Juvenile Delinquency* (2<sup>nd</sup> Edition), Oxford University Press, New York, ISBN 0-19-506407-0

Lyew M., (April 1996), *A new weapon for fighting crime*, GIS Europe, xviii-xx

- Maguire M., Morgan R. and Reiner R. (eds), (1997), *The Oxford Handbook of Criminology* (2<sup>nd</sup> Edition), Oxford University Press, New York, ISBN 0-19-876485-5
- Malta Government, (1980), Juvenile Court Act: Chapter 287 of the Laws of Malta
- Malta Today, (2005), The Unholy War, Sunday 4<sup>th</sup> September 2005
- MaltaToday Editorial, (12th October 2003), (accessed 16 February 2004), The need to respond to paedophilia cases in the church - <http://www.maltatoday.com.mt>
- MaltaToday, (2002), *Victims of Rape*, MaltaToday, 30 June 2002
- Maltz M.D., Gordon A., and Friedman W., (1991), *Mapping Crime in its Community Setting: Event Geography Analysis*. Springer-Verlag, New York
- Marshall, T.H., (1949), *Citizenship and Social Class*, IN *Class, Citizenship and Social Development*. Chicago: Chicago University Press
- Martinez Jr., R., (1997), Predictors of Serious violent recidivism: results from a cohort study. *J. Interpers Violence* 12, 216-228
- Matza D., (1964), *Delinquency and Drift*, New York, John Wiley
- Mayhew P., Maung N.A., and Mirrlees-Black C., (1993), *The 1992 British Crime Survey*. Home Office Research Study 132, London: HMSO
- Mayhew P., Clarke R.V.G., Sturman A., and Hough J.M., (1976), *Crime and Opportunity*, Home Office Research Unit Study No. 34, London, HMSO
- Mays J.B., (1963), *Delinquency areas: A Re-Assessment*, *British Journal of Criminology*. 3:216-30
- McClintock F.H., (1963), *Crimes of Violence*. Macmillan and Company, London
- McCorquodale K., (accessed 9 January 2003), Accounting for Rural Deprivation, Thinknet - <http://www.think-net.org/noticeboard.asp?NoticeID=18>
- McEwen J.T., and Taxman F.S., (1995), *Applications of computer mapping to police operations*, IN J.E. Eck and Weisburd D., (eds), *Crime and Place*. Monsey, NY: Criminal Justice Press; and Washington, DC: Police Executive Research Forum, pp. 259-284.
- McGarrell E.F., Giacomazzi, A.L., and Thurman Q.C., (September 1997), *Neighbourhood disorder, integration and the fear of crime*. *Justice Quarterly*, Vol. 14 No. 3, 479-500
- McKean J., and Byers B., (2000), *Data Analysis for Criminal Justice and Criminology: Practice and Applications*. Allyn and Bacon, Needham Heights, MA, USA, ISBN 0-205-27480-3
- McLaughlin E. and Muncie J., (eds), (2001), *The Sage Dictionary of Criminology*. Sage Publications, London
- Merton R.K., (1968), *Social Theory and Social Structure*. The Free Press, New York
- Messner and Golden, (1992) quoted from Wang Y.R., (1999), Political Change and Public Security – The Prospect of Taiwan. *Futures* 31, 57-72

- Miller J.M.M. and Tewksbury R., (2000), *Extreme Methods: Innovative Approaches to Social Science Research*. Addison Wesley Longman, Inc.
- Ministry of Finance, (2005), Source: MEPA, 2001, Economic Survey: January-September 2005, Economic Policy Division.
- Mintoff, (1961), *Lehen is-Sewwa*. Pg 4
- Moffitt T.F., (1993), *Adolescence-limited and Life-course-persistent Antisocial Behaviour: A Developmental Taxonomy*. Psychological Review, 100 (1993): 674-701.
- Montgomery J., (1998), *Making a city: urbanity, vitality and urban design*. Journal of Urban Design, Vol. 3 No. 1, 93-116
- Morris T., (1957), *The Criminal Area*. Routledge and Kegan Paul, London, pg. 65-91
- Moss G., (1997), *Explaining the absence of violent crime among the Semai of Malaysia: Is criminological theory up to the task?* Journal of Criminal Justice, Vol. 25, No. 3, pp 177-194
- National Institute of Justice (NIJ), (accessed 25 February 2004) - <http://www.ojp.usdoj.gov/nij/maps/software.html>
- Neis P., Fink T., Dilger M., and Rittner Ch., (2000), *Use of the software 'Poser 4' in reconstruction of accident and crime scenes*. Forensic Science International 113 (2000) 277-280
- Newman O., (1973), *Defensible Space*, London, Architectural Press
- Newman O., (1972), *Defensible Space: Crime Prevention through Urban Design*. New York, Macmillan
- NSO, (December 2002), *Structural, Poverty and Social Exclusion Indicators*. Malta
- Openshaw S., (1993), *GIS 'crime' and GIS 'criminality'*, *Environment and Planning*. 25(Apr), 451-458
- Pain R.H., (1994), *Social Geographies of Women's Fear of Crime*. Trans Inst Br Geog, NS 22 231-244
- Pease K., (2001), *What to Do About It? Lets turn off our minds and GIS*, IN Hirschfield A., and Bowers K., (eds), (2001), *Mapping and Analysing Crime Data: Lessons from Research and Practice*. Taylor & Francis, London, ISBN: 0-748-40922-X
- Pease K., (1988), *Judgements of Crime Seriousness: Findings from the 1984 British Crime Survey*, London, Home Office
- Planning Authority, Demography Topic Paper, (2001), Planning Authority, publishing inhouse
- Planning Authority, Housing Topic Paper, (2002), Planning Authority, publishing inhouse
- Planning Authority, Retail Topic Paper (2001), Planning Authority, publishing inhouse
- Planning Authority, Tourism Topic Paper (2001), Planning Authority, publishing inhouse
- Plucknett T.F.T., (1960) *Edward I and the Criminal Law*. Cambridge, United Kingdom, Cambridge University Press
- Prison Files, (1990-2001), Corradino Correctional Facility, Malta

Putnam R.D., (1993), *Making Democracy Work: Civic Traditions in Modern Italy*. Princeton University Press, Princeton NJ, (cf Kawachi I., Kennedy B.P., Wilkinson R.G., (1999), *Crime: social disorganisation and relative deprivation*. Social Science and Medicine 48 (1999) 719-731)

Pyle G., (1974), *The Spatial Dynamics of Crime*. University of Chicago Press, Chicago

Pyle G.F., (1976), *Spatial and Temporal Aspects of Crime in Cleveland*. Ohio, American Behavioural Scientist, 20(2), 175-197

Radburn S., (2003), (accessed 25 February 2004) Data exchange and Crime Mapping, A guide for crime and disorder partnerships - <http://www.crimereduction.gov.uk/technology01.htm>

Reiss, A. J. (1986), *Why are Communities Important in Understanding Crime?*, IN Reiss A.J., and Tonry M., (eds.), *Communities and Crime: Crime and Justice, A Review of Research, Volume 8*. Chicago: University of Chicago Press.

Rengert G.F., (1980), *Spatial Aspects of Criminal Behavior*, IN Georges-Abeyie D.E. and Harries K.D. (eds), *Crime: A Spatial Perspective*. New York, Columbia University Press

Rex, J. and Moore, R. (1967) *Race, community and conflict: A study of Sparkbrook*., Oxford: Oxford University Press

Rhodes W.M. and Conly C., (1991), *Crime and Mobility: An Empirical Study*, IN Brantingham P.J. and Brantingham P.L. (eds), *Environmental Criminology, Prospect heights*. IL, Waveland Press

Rich T., (1995), *The Use of Computerised Mapping in Crime Control and Prevention Programs*. U.S. Department of Justice, Office of Justice Programs, Washington D.C. - <http://www.ncjrs.org/txtfiles/riamap.txt>

Robson C., (1993), *Real World Research*. Blackwell, Oxford, UK, ISBN 0-631-17689-6

Rutter M., Maughan B., Mortimore P., and Ouston J., (1979), *Fifteen Thousand Hours: Secondary Schools and their Effects on Children*. London: Open Books

Saferstein R., (1998), *Criminalistics: An Introduction to Forensic Science*. (6<sup>th</sup> Edition), Prentice Hall, New Jersey

Sampson R.J., (1995), *The Community* IN Wilson J.Q. and Petersilia J., (eds), *Crime, Institute for Contemporary Studies*. San Francisco, pp: 193-216 (cf Kawachi I., Kennedy B.P., Wilkinson R.G., (1999), *Crime: social disorganisation and relative deprivation*. Social Science and Medicine 48 (1999) 719-731)

Sampson R.J., and Groves W.B., (1989), *Community Structure and Crime: Testing Social-Disorganization Theory*. American Journal of Sociology 94, 774-802 (cf Kawachi I., Kennedy B.P., Wilkinson R.G., (1999), *Crime: social disorganisation and relative deprivation*. Social Science and Medicine 48 (1999) 719-731)

Sampson R.J., Raudenbush S.W., Earls F., (1997), *Neighbourhoods and violent crime: a multilevel study of collective efficacy*. Science 277, 918-924 (cf Kawachi I., Kennedy B.P., Wilkinson R.G., (1999), *Crime: social disorganisation and relative deprivation*. Social Science and Medicine 48 (1999) 719-731)

Sanderson J., (1994), *Criminology Textbook*. (5<sup>th</sup> Edition), HLT publications, London, ISBN 0-

SAS (JMP – check if it is the same), (accessed 25 February 2004) - [http://www.jmp.com/product/jmp\\_intro.shtml](http://www.jmp.com/product/jmp_intro.shtml)

Schembri K., (19th October 2003), (accessed 16 February 2004), Curia placed priest with alleged sex abuse history at government school. – <http://www.independent.com.mt>

Schissel B., (1992), *The Influence of Economic Factors and Social Control Policy on Crime Rate Changes in Canada, 1962-1988*. Canadian Journal of Sociology 1992:17 (4): 405-28

Schissel B., (1996), *Law reform and social change: a time-series analysis of sexual assault in Canada*. Journal of Criminal Justice, Vol. 24, No. 2, pp 123-138

Schmid C.F., (1960), *Urban Crime Area: Part I, American Sociological Review*, 25, 1960, pg. 527-542; *Urban Crime Areas: Part II, American Sociological Review*. 25, 1960, pg. 655-678

Schmid C.F., (1960), *Urban Crime Area: part II, American Sociological Review*. 25: 655-78

Schneider J., (1988), *Toward an Environmental View of Inner-City Crime*. Law and Society Review 22(5), 1023-1026

Schnore L., (1963), *The Socioeconomic Status of Cities and Suburbs*, American Sociological Review 28:76-85

Schrag J., and Scotchmer S., (1997), *The Self-Reinforcing Nature of Crime, International Review of Law and Economics*. 17:325-335, 1997

Schurman, L., and Kobrin S., (1986), *Community Careers in Crime*, IN Reiss A. and Tonry M. (eds.) *Communities and Crime*. Chicago: University of Chicago Press

Schwane S.L., (2000), *“Stick ‘em up, buddy” Robbery, Lifestyle and Specialization within a Cohort of Parolees*. Journal of Criminal Justice 28 (2000) 371-384

Sellin T., and Wolfgang M.E., (1970), *Measurement of Delinquency*, New Dehli, Wiley Eastern Private Limited

Seychell A., and Tonna B., (1994), *Poverty in Malta - A First Report*, CARITAS-DISCERN, Malta, Caritas Poverty Watch Team

Shaughnessy J.J. and Zechmeister E.B., (1997), *Research Methods in Psychology*. (4<sup>th</sup> Edition), McGraw-Hill, USA, ISBN 0-07-057272-0

Shaw C.R. and McKay H.D., (1942), *Juvenile Delinquency and Urban Areas*. University of Chicago Press, Illinois

Shaw C.R., (1929), *Delinquency Areas*. University of Chicago Press, Chicago

Shaw-Taylor Y., (1998), *Profile of Social Disadvantage in the 100 Largest Cities of the United States, 1980-1990/1993*. Cities, Vol. 15, No. 5, pp. 317-326

Sherman L.W., Gartin P.R., and Buerger M.E., (1989), *Hotspots of Predatory Crime: Routine Activities and the Criminology of Place*. Criminology 27: 27-55 (cf Bottoms and Wiles, 2001 IN Evans et al 2001)

Singleton G.H., (1973), *The Genesis of Suburbia. A Complex of Historical Trends IN Massotti*

- L. and Hadden J., (eds), *The Urbanization of the Suburbs*, Beverly Hills, CA, Sage
- Skogan W.G., (1986), *Fear of Crime and Neighborhood Change*, IN Reiss A.J., and Tonry M., (eds.), *Communities and Crime: Crime and Justice, A Review of Research*, Volume 8. Chicago: University of Chicago Press.
- Smith J.C. and Hogan B., (1994), *Criminal Law* (7<sup>th</sup> Edition), Butterworth & Co, London, ISBN 0-406-00313-0
- Smith R.B., (Editor), (1985), *Handbook of Social Science Methods*, Vol. 3: Quantitative Methods, Focused Survey Research and Causal Modeling. Greenwood Publishing Group, Incorporated
- Smith V.L., (1998), *War and Tourism: an American ethnography*. *Annals of Tourism Research*, Vol. 25 No. 1, pp 202-227
- Snodgrass J., (1976), *Clifford R. Shaw and Henry D. McKay: Chicago Criminologists*, *British Journal of Criminology*, 16: 1-19
- Snow J. (1855), (Jan 2002), *On the Mode of Communication of Cholera*. - [http://www.ph.ucla.edu/epi/snow/snowmap1\\_1854.html](http://www.ph.ucla.edu/epi/snow/snowmap1_1854.html)
- SPSS, (accessed 25 February 2004) - <http://www.spss.com/>
- Sultana R. and Baldacchino G., (eds), (1994), *Maltese Society: A Sociology Enquiry*. Mireva Publications, Msida, ISBN 1-870579-24-0
- Summerson, H.R.T., (1992), *The Enforcement of the Statute of Winchester, 1285-1327*. *Journal of Legal History*, 13 (1992), 232.
- Svensson B., (1995), *Criminal Justice Systems in Europe: Sweden*. HEUNI European Institute for Crime Prevention and Control, affiliated with the United Nations, Printus AB, Stockholm, ISBN 91-38-30482-1
- Tabone C., (1995), *Maltese Families in transition: A Sociological Investigation*. Ministry for Social Development, Malta
- Tabone C., (30 September 2001 - last accessed on 16th April 2006), *Social Housing Now and In The Future: Target Groups In Need Of Social Housing*. - <http://www.msp.gov.mt/services/subpages/content.asp?id=440>
- Tanti Dougal M., (1994), *Patterns of Crime*, IN Sultana R.G. & Baldacchino G. (eds), (1994), *Maltese Society: A Sociological Enquiry*. MIREVA Publications, Msida, Malta
- Taub R., Taylor D.G., and Dunham J.D. (1984), *Paths of Neighborhood Change*, Chicago, Ill., University of Chicago Press
- The Malta Independent (5 May 2006), *Sexual Assault in Paceville*, - <http://www.independent.com.mt/news.asp?newsitemid=32714>
- Times of Malta Editorial, (Monday, October 2, 2006), *In pursuit of a good, safe time*. Times of Malta. - [http://www.timesofmalta.com/core/print\\_article.php?id=238745](http://www.timesofmalta.com/core/print_article.php?id=238745)
- Times of Malta, (March 16, 2006), *Prison Population*
- Todorovich A., (1970), *The Application of Ecological Models to the Study of Juvenile Delinquency in Belgrade*, IN *United Nations, International Review of Criminal Policy* 28. pg.

- Toffler A., (1982), *The Third Wave*, Bantam Books. New York, ISBN 0-553-24698-4
- Tonna B., (1995), *Signs Trends Values: A Report on the Signs of the Times for 1995*, DISCERN, Malta
- Tonna B., (1996), *Poverty in Malta - A Second Report*, CARITAS-DISCERN, Malta, Caritas Poverty Watch Team
- Tonna B. and Mangion L., (1998), *Poverty in Malta - A Third Report*, CARITAS-DISCERN, Malta, Caritas Poverty Watch Team
- Townsend P., Phillimore P., and Beattie A., (1988), *Health and Deprivation: Inequality and the North*, London, Croom Helm, (cf Craglia M., Haining R., and Wiles P., (April 2000), *A Comparative Evaluation of Approaches to Urban Crime Pattern Analysis*, *Urban Studies*. Vol. 37, No. 4, 711-729, 2000, University of Glasgow)
- Troisi J., (1995), *The elderly and changing family roles: the Maltese and European perspectives*, IN Formosa S., (1995), *Age Vault*. INIA, Valletta, ISBN 92-9103-030-9
- Turvey B., (2001), *Criminal profiling: An Introduction to Behavioral Evidence Analysis*. Academic Press, London, ISBN 0-12-705040-x
- UNDP, (1994), *Human Development Report*. Oxford, New York
- United Nations, (2003), *InstrumentE, Questionnaire for the Seventh United Nations Survey of Crime Trends and Operations of Criminal Justice Systems, covering the period 1998 – 2000*. Centre for International Crime Prevention Office for Drug Control and Crime Prevention and Statistics Division Department of Economic and Social Affairs, United Nations
- United Nations, (2003), *Seventh United Nations Survey of Crime Trends and Operations of Criminal Justice Systems, covering the period 1998-2000: United Nations Office on Drugs and Crime* (accessed on October 2004) - [http://www.unodc.org/unodc/en/crime\\_cicp\\_survey\\_seventh.html](http://www.unodc.org/unodc/en/crime_cicp_survey_seventh.html)
- US Bureau of Census (accessed on Jan 2003) - <http://www.census.gov/hhes/poverty/povmeas/ombdir14.html>
- Van der Wurff A., Van Staalduinen L., and Stringer P., (1989), *Fear of Crime in Residential Environments: Testing a Social Psychological Model*. *Journal of Social Psychology*, 129/2:141-60
- Van Kesteren, J.N., Mayhew, P., and Nieuwebeerta, P., (2000) *Criminal Victimization in Seventeen Industrialised Countries: Key-findings from the 2000 International Crime Victims Survey*, The Hague, Ministry of Justice, WODC.
- Vancell S., (2003), *Crime and housing estate design: a case-study in Malta*. unpublished B.E.&A.(Hons.) thesis, University of Malta
- Wagner A.E., (1997), *A study of traffic pattern modifications in an urban crime prevention program*. *Journal of Criminal Justice*, Vol. 25 No. 1, pp 19-30
- Walklate S., (2000), *Understanding Criminology*. Open University Press, Buckingham, UK, ISBN 0-335-19361-7



- Wang Y.R., (1999), *Political Change and Public Security – The Prospect of Taiwan*. *Futures* 31, 57-72
- Wasserman, L. (2005). *All of Statistics: A Concise Course in Statistical Inference*, Springer Texts in Statistics
- Weisburd, D., Elin W., and Ellen C., (2000), (accessed 28 January 2003), White-Collar Criminal Careers. 1976-1978: Federal Judicial Districts - <http://www.icpsr.umich.edu:8080/ABSTRACTS/06540.xml?format=NACJD>
- Wenger C.G. and Shahtahmasebi S., (1989), *Network Variation: Demographic Correlates of Network type*. Centre for Social Policy Research and Development, University of Wales, Bangor
- Wenger C.G., (1994), *Support Networks of Older People: A guide for Practitioners*. Centre for Social Policy Research and Development, University of Wales, Bangor
- Whyte W.H., (1943), *Street Corner Society*. Chicago, University of Chicago Press (cf Bottoms and Wiles, 2001 IN *Evans et al* 2001)
- Wikstrom P., (1990), *Delinquency and the Urban Structure*, IN Wikstrom P., (Ed), *Crime and Measures Against Crime in the City*, Stockholm, National Council for Crime Prevention
- Wilkinson R.G., (1996), *Unhealthy Societies: The Afflictions of Inequality*. Routledge, London, (cf Kawachi I., Kennedy B.P., Wilkinson R.G., (1999), *Crime: social disorganisation and relative deprivation*. *Social Science and Medicine* 48 (1999) 719-731)
- Williamson D., McLafferty S., Goldsmith V., Mollenkopf J and McGuire P., (accessed 25 February 2004), A better method to smooth crime incident data, *ESRI ArcUser Magazine* Jan.-March 1999, - <http://www.esri.com/news/arcuser/0199/crimedata.html>
- Wilson, J. and Kelling. G., (1982), *The Police and Neighborhood Safety: Broken Windows*, *Atlantic Monthly*, 127: 29-38
- Wilson W.J., (1996), *When Work Disappears: The World of the New Urban Poor*. Alfred Knopf, New York
- Withers S.D., (2001), *Quantitative methods: advancement in ecological inference*. *Progress in Human Geography*, 25, 1, pp 87-96
- Witt R., Clarke A., and Fielding N., (1998), *Common trends and common cycles in regional crime*. *Applied Economics*, 30, 1407-1412
- Wolfgang M.E., Figlio R.M. and Sellin T., (1972), *Delinquency in a Birth Cohort*, Chicago, University of Chicago Press
- Wolpin K.I., (1978), *An Economic Analysis of Crime and Punishment in England and Wales 1894-1967*. *J. Political Econ* 86, 815-840 (cf IN Entorf H., and Spengler H., (2000), *Socio-economic and demographic factors of crime in Germany: Evidence from Panel Data of the German States*, *International Review of Law and Economics* 20 (2000), 75-106)
- Woodby K., (2003), *Austin, Texas, Police Department takes a bite out of burglary with GIS*. *ArcNews*, Spring 2003, Vol. 25 No. 1
- Woods M., (2002), *Site Mapping Technology and Crime Mapping*, IN *Advances crime mapping techniques, Results of the First Invitational Advanced Crime Mapping Topics*

*Symposium*. June 2001, Denver Colorado, CMAP

Worsley P. (ed), (1991), *The New Modern Sociology Readings*. Penguin Books, Middlesex, England, ISBN 0-14-014337-8

Worsley P. (ed), (1992), *The New Introducing Sociology*. Penguin Books, Middlesex, England, ISBN 0-14-013594-4

Young J. (1997), *Left Realist Criminology*, IN Maguire M., Morgan R. and Reiner R., (1997), *The Oxford Handbook of Criminology*. Oxford University Press, Oxford

Zammit R., (2004), *Meta Jibki l-Korp*, Printwell Ltd., Fgura, ISBN: 99932-0-310-6

Zammit R., (2005), *Tribute to our Heroes*, P.E.G. Ltd., ISBN 99932-0-408-0

Zammit R.G. (2006), *Capital Punishment In Malta - Depth Analysis of a death sentence*. unpublished BA Criminology thesis, University of Malta

Zedner L., (1997), *Victims*, IN Maguire M., Morgan R. and Reiner R., (1997), *The Oxford Handbook of Criminology*. Oxford University Press, Oxford

## Appendices

- Appendix 1: Abbreviations
- Appendix 2: GIS and Crime
- Appendix 3: Creating a new Crime Classification System for the Maltese Islands
- Appendix 4: Metadata
- Appendix 5: Geocoding Lineage
- Appendix 6: UN Crime Definition and Malta in Europe and in islands Perspectives
  - United Nations (2003) InstrumentE (questionnaire) extract
  - Crime Maps: Malta in Europe and Islands perspectives
- Appendix 7: Offences in Malta - a 50 year perspective
- Appendix 8: Crime Maps – Overlaying Offender and Poverty Hotspots by Locality
- Appendix 9: Craglia Rate and Risk Assessment Methodologies
- Appendix 10: Crime Maps: Overlaying Offence and Recreation Hotspots by Locality

## Appendix 1: Abbreviations

---

CCF – Corradino Correctional Facility – prison in Paola

CCTV – close circuit television

CDb - Common Database

COS – Central Office of Statistics, refer to NSO

COTC – Dataset comprising prisoner data: offender data from 1950-1999, offence data from 1990-1999

CRISOLA - crime, social and landuse structure

EUROSTAT – European Statistical Agency

GEOPOL – reported offences to the police as per PIRS output

GIS – Geographical Information System

HOS – Home Ownership Scheme (also known to refer to Government Housing Estates)

ISCO - International Standard Classification of Occupations

Limdev – Limits to Development

MEPA – Malta Environment and Planning Authority – previously the Planning Authority

NNA – Nearest Neighbour Analysis

NNH – Nearest Neighbour Hierarchical Spatial Clustering

NSO – National Statistics Office formerly COS – Central Office of Statistics

NUTS - Nomenclature des unites territorielles pour statistique – European Union Classification  
NUTS 1 and 2 – National  
NUTS 3 – Islands  
NUTS 4 – Districts  
NUTS 5 – Local Councils

ODZ – Out of Development Zone area

PIRS - Police Information Retrieval System

SDe - Standard Deviational Ellipse

StDev - Standard Deviation

SWOT - Strengths, Weaknesses, Opportunities and Threats

TPS – Temporary Provision Schemes

UCA\_VC – Urban Conservation Area \_ Village Core

UCR – Uniform Crime Report

## **Appendix 2 : Geographical Information Systems (GIS)**

The best way to identify the role of such information systems would be to introduce the technology. “A geographical information system is a group of procedures that provide data input, storage and retrieval, mapping and spatial and attribute data to support the decision-making of the organisation” (Grimshaw, 1994).

This definition would not be complete without reference to the data process itself that identifies GIS as being able to mine, capture, store, retrieve, manipulate, geocode, georeference, display and analyse locational data.

However, data creation is not an end in itself, nor does it serve itself: it must be able to support decision-making in matters that have a geographical context.

GIS technology has advanced greatly over the last years from a situation driven by proprietary applications to fully-customisable applications based on clients’ needs rather than the ‘pre-cooked’ package available a few years back. The main changes are very visible; from command-line-based interfaces to graphic-based (GUI) ones that are user-friendly and provide a wide range of functions through algorithmic functions, spatial and tabular methodologies, either through manual or automated procedures. The main software in use are MapInfo, Vertical Mapper, ArcGIS, ARCVIEW, Idrisi, Maptitude, and Geomedia.

### 1.1 Overview of the technology

#### **How does GIS operate: in which worlds?**

The main concept in GIS is layering, where through the use of themes any type of information can be analysed either separately or collectively. The cross-layer or dataset analysis function is a *forte* since it allows a combination of database and mapping functions from different information, graphic and tabular sources. These collections of themes form a GIS database. Also, the main difference from CAD/CAM and DBMS is that GIS combines mapping, data manipulation and data storage functions from different sources and even manipulates large datasets from remote sites and uses parts of different data/information sources (eg. height from a relief map and population from a database).

Research studies that involve GIS have to adhere to a specific process of data collection, storage, analysis and output. The process involves a four-step methodology as outlined below – for each phase crime-related examples are given:

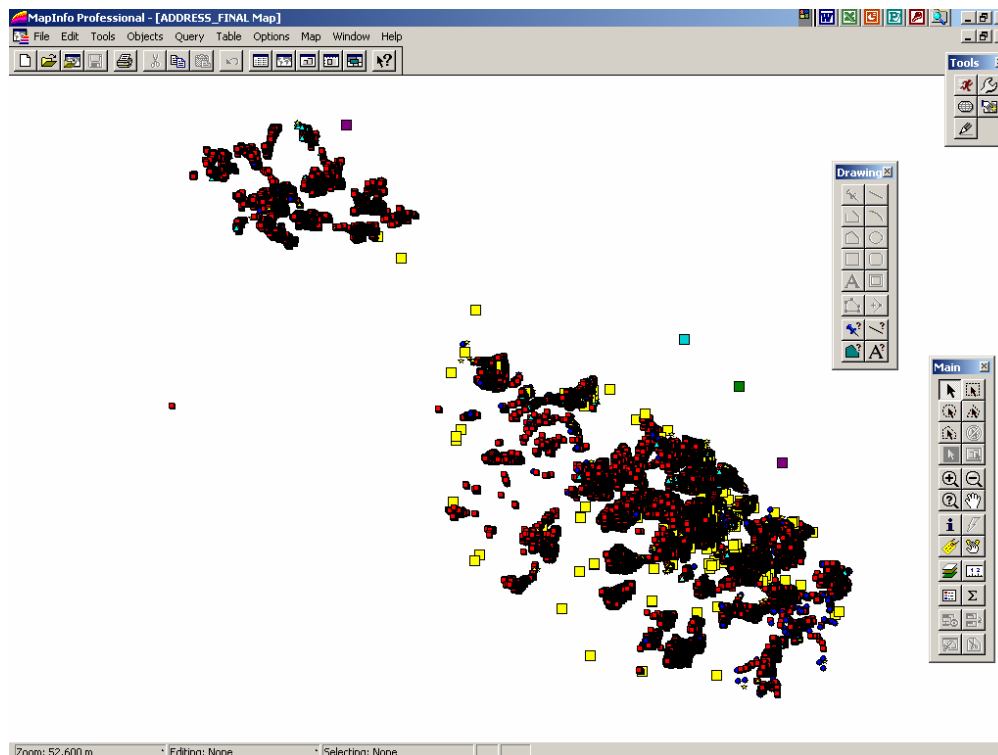
- a) Data acquisition, input and verification
  - Remotely sensed data, scanning, digitising, manual inputting (scanned analogue hotspot crime maps, annual crime statistics) in different standardized formats and sources
  - Quality control constraints (manual and automated input checking)
  - Managing projections and scale issues in single maps or in different layers
  - Enables geocoding and georeferencing of non-spatial data to spatial data. Figure 1 shows the result of the geocoding exercise carried out in this study, which was aimed at transposing all reported crimes reported in the Malta police database into GIS format.
  
- b) Data storage and database management
  - Database management systems (DBMS). Crime-related database systems include a specialized CrimeStat software, Police databases, prison statistics, PIRS (Police Information Retrieval System<sup>168</sup>)
  - DBMS must allow operations that relate spatial with non-spatial data
  - Distributed data (data from different sources such as stations and police mobile squad input linked to a car tracking system in a private organisation)
  
- c) Data analysis and modeling
  - Layering (listing all crime layers to form a set of inter-layer analysis tools such as police data on crime location and address point database)
  - Integrating internal and external datasets (police central data linked to individual station datasets)
  - Allows spatial data selection and promotes the use of spatial querying systems such as SQL to query both spatial and attribute data
  - Data analysis allows multiple functions such as proximity and distance analysis (distance of offender residence to target), buffering (creating incidences of crime for every specified distance, e.g.: 50m from a school)
  - Allows spatial statistical functions
  
- d) Data display and outputs

---

<sup>168</sup> <http://www.pulizija.gov.mt/>

- Mapped information, output reports to the police headquarters, 3D crime density maps, hotspot crime maps that depict concentrations of crime in particular areas resulting in a highest to lowest interpolation map
- Allows the creation of thematic maps and displays multiple thematic outputs in one or more interfaces
- Allows the visualization of data in multiple formats inclusive of tables, charts, maps, animations and virtual worlds
- Allows the promotion of GI data over web-interfaces and mapservers

Figure 1: Geocoding crime locations



Source: The Author

## 1.2 The future for GIS and crime

The high and rapid developments in the technologies that are GIS augurs well for the development of analysis tools that span disciplines beyond the physical and natural sciences but will continue its venture into the social sciences. The main areas where GIS-for-crime is heading over the next few years are listed below with references to the contribution to crime analysis.

- **artificial intelligence** – enables the automated analysis of prediction modeling and huge-database analysis in real-time. Examples include: gravity models

(predicting crime hotspots based on proposed future commercial development), automated mobile police and vehicle tracking;

- scene generation and **virtual reality**: places user in the GIS and allows interaction with databases. Examples include: 3D landuse-structure leading to a police-district visualization model for operational and tactical activities, 3D crime density modeling and journey-to-crime visualizations;
- **multimedia** – enables crime-scene review for court aids development. An examples: reconstruction of a murder scene and victim-aggressor positions through use of tools such as Poser 4 (Neis *et al*, 2000);
- improved data handling through **standard formats**. Examples include: lineages, cross-departmental/organisation distributed data and data sharing;
- integration of new spatial analysis techniques – **GIS in other software**. Examples include: specialized crime tools with GIS modules such as ArcView and Crime Analysis Extension<sup>169</sup>;
- **web mapping** – the state-of-the-art mode of IS since it brings information to users irrespective of their location and access to the original dataset. Examples include: real-time on-line crime tracking and data-input by mobile squads, paroled/bracketed offender tracking;
- links to **national databases** on social data that help predict change and help identify locations where crime may occur. Examples include: crime and landuse modeling and social-change analysis as studied against crime.

### 1.3 Development of the technology

Use of GIS technology has already moved away from the dominance of analysis relating to the physical world. With ever decreasing computer hardware costs and higher capabilities, GIS is more readily available from the shops. Howard (2002) states the case for a good GIS package based on a SCORE set of parameters facilitating access to spatial and crime data: **S**calable, **C**ommercial off-the-shelf software, **O**pen, **R**edundant (all users use same structure irrespective of expertise) and **E**asy. With these points in mind many a researcher started investigating crime for a different angle: the GIS angle.

The social sciences have started to gain in this field, mainly in the areas of health and policing services (Craglia *et al*, 2000). Although different methodologies could be used to analyse these different areas, comparative studies show that there are similarities in approaches, particularly

---

<sup>169</sup> The Crime Analysis Extension was development of the Crime Analysis application was supported under an award from the National Institute of Justice (NIJ), Department of Justice.



since they are thought to share a common causal factor based on descriptive, behavioural, spatial and temporal commonality (Bair, 2002).

#### 1.4 Impact of GIS on crime research and analysis

The main issue in GIS centres on the importance of the locational aspect of data. Relatively few cases exist where data does not have a geographical (spatial) component and even these can be related to another dataset that has a locational construct. In effect, Geographic Information is information that can be related to a specific position or location on the Earth. In the study of crime, space is important to the extent that most cases can be directly linked to a point in space both due to the place where the offences occur as well as the place where the offenders reside.

Crime has a locational component, though in some cases this proves to be a daunting task: theft can occur in a street; however other offences such as fraud are more difficult to be assigned a location. These cases merit mention in an environmental criminology study due to the fact that there are diverse factors involved such as the place where the persons (involved in crime) met, the location where cheques were cashed, etc. In such cases the residence location of the offender may still prove to be helpful especially if that is the place where s/he carries out the preparation/completion of the crime such as storing criminal proceeds (e.g. stereos, etc) or where s/he procures/sells drugs. It is imperative to note that there may be two different offence locations for the same crime: i) where victim was picked up, ii) where assault such as rape, occurred (Bruce, 2002, 25) and iii) where the victim lives (if different from i) and iv) where the offender lives.

#### 1.5 Querying tools

The introduction of specialized statistical tools and GIS has helped to push crime analysis in a totally different tangent. Statistical tools such as SPSS<sup>170</sup>, SAS<sup>171</sup>, and even basic spreadsheet tools such as Microsoft Excel, helped in the identification of trends. However, the main boost came with the development of spatial information systems and related crime-mapping modules.

- Structured Query Language (SQL)

This technology allows users to overlay and query data through the use of simple SQL (Structured Query Language) capabilities, from different datasets in different digital maps. Such tools allow analysis using spatial functions as is the ability to search within specific delineated areas,

---

<sup>170</sup> <http://www.spss.com/>

<sup>171</sup> <http://www.sas.com/>

intersecting areas and, offence point locations within specific retail areas, amongst others. This type of functionality could only occur with the use of GIS technologies and again this was value added through crime-specific statistics tools such as CrimeStat.

GIS is practical in both investigative (through real-time crime surveillance and data tracking) and in research-oriented analysis (such as spatio-temporal analysis of a category of crime). Also, tactical crime analysis and strategic planning criminal analysis can make the most of the above-mentioned technologies and tools. Few, if any analysis activities can be exempt from the data creation process; from the analysis of different layers of information, through the use of such querying tools as (SQL), to the final output in the diverse forms mentioned above. Throughout the process, specialised tools may be needed to help users to analyse data specific to crime. Both attribute and spatial queries are possible through the possibility of such additions to the non-spatial SQL commands such as 'within' and 'contains'. Thus, a GIS can carry out functions that are both based on normal database querying facilities, but have a value-added function where the same data can be analysed in a spatial context.

- Thematic mapping

GIS is vital for contemporary research due to a process that is both technical and psychological. A fully-fledged GIS facilitates both the process of producing a map as well as analyzing that same data output in diverse thematic forms. The process of displaying something as an image is termed Visualization and is the result of a process that converts data and gives it meaning in the form of information. This can be carried out through a system of tools such as thematic mapping, as well as a host of querying facilities. However, every output needs to be interpreted by the eventual reader and any image must make sense both to the researcher and to the user who may have interpretation differences based on his socio-cultural make-up. Thus through the use of GIS, a user can carry out the process of Visualization which is the mental process of forming an image based on the patterns that are observed in the analysis outputs.

### Appendix 3: Creating a new Crime Classification System for the Maltese Islands

The categories of crime that were available from 1960 to July 1997 were re-categorised from August 1997 to reflect the current categories as used by the Malta Police Force in the Police Incident Reporting System (PIRS). The National Statistics Office publications state (1949-2003) that the two different datasets cannot be compared due to the different methodologies and classifications employed over time in gathering the data.

Table A3-1 lists the Post-1997 Categories with sub-Categories as compared to the Pre-Categories as outlined in the tables above. No attempt has been made to compare the figures in continuation as some of the data overlaps between the different categories or is uncategorised.

*Table A3-1: Crime Categories for the two periods: Pre-1997 and Post-1997*

Pre-1997 Categories	Post 1997 - Main Categories	Post 1997 - Sub Categories
	Abortion/supply of poisonous substance	
	Abuse of public authority	
	Abuses relating to prisons	
	Against morals/honour - family	
	Arson	
Attempted theft	Attempted offences	Attempted arson
		Attempted bodily harm
		Attempted damage
		Attempted homicide
		Attempted sexual offence
		Attempted theft
	Bankruptcy offences	
	Bigamy	
Offence against the person	Bodily harm	Domestic violence
		General bodily harm
	Computer misuse	
	Concealment of bodies	
	Crimes against public peace	
	Crimes against public safety	
	Crimes against religious sentiment	
	Crimes against the administration of justice etc	
Causing damage to property + hit and run	Damage	By acid
		By explosion
		By paint
		By shot
		General damage
		Hit and run
	Drugs	
	Forgery	
Fraud	Fraud	

Pre-1997 Categories	Post 1997 - Main Categories	Post 1997 - Sub Categories
Wilful murder + involuntary homicide	Homicide	
	Immigration	
	Infanticide/abandonment of child	
	Malversation by public officer	
	Perjury & false swearing	
	Prostitution	
	Safety of the government	
Sexual offences	Sexual offence	
Theft from premises inside town or village + theft in other areas + petty theft + pick pocketing + snatch and grab + theft from unattended motor vehicles + theft of/from seacraft + driving motor vehicle without owner's consent	Theft	General theft
		Hold-up
		Pick-pocketing
		Snatch and grab
		Theft from bars/hotels
		Theft from beaches
		Theft from factories
		Theft from residence
		Theft from retail outlets
		Theft from seacraft
		Theft from vehicle
		Theft of seacraft
		Theft of vehicle
Anonymous telephone calls and letters	Threats and private violence	
	Trafficking of persons	
	Violation of places of confinement	
	Violence against public officer	

*Note: colours signify distinct categories that have been aggregated or disaggregated.*

*White cells indicate new crime categories introduced.*

The table lists a new structure of crime reporting that is employed by the Malta Police Force, which categories are clearer in structure through its Main and Sub-Categories distinction. Some categories were disaggregated into a number of different sub-categories, whilst others were integrated.

Once this classification has been outlined, the researcher identified the need to fit Maltese crime categories within a wider-world construct that reflects both new crimes and a wider-base need for data at finer levels, as well as create an internationally recognised structure.

Such would be to create a wider crime classification system to reflect the growing number of crime categories and the relevant sub-categories. In effect, following a review of the Police categories, and discussions with police officers, review of the local prison sentence categories and a review of the UK-crime categories, a classification was created as part of this study. The process

entailed the integration of the post-1997 Malta Crime categories to the UK crime categories, which classification would aid the Malta Police to further refine their data to reflect a wider crime context.

The methodology employed in this part of the study was based on a process where the Maltese categories were conciliated with the UK categories, mainly from the HMO<sup>172</sup> list and the University of Huddersfield's Kirklees 4<sup>th</sup> Crime Audit. The list of Maltese crime categories and sub-categories was compared to the UK one and re-organised to reflect the wider-context UK one. Offences pertaining to the local context as identified during the data gathering process at the Maltese Prison and as per the Police submissions, were included in the list.

A Proposed Integrated Crime Classification Structure for the Maltese Islands that includes all potential crimes, with serious categories topping the list has been created and made available in Appendix 8 as it is too large a table to fit here. Codifications are based on the initial sequence given to each different data source and the author's unique classification code. In conclusion the final Code would refer to that entitled: **UK CatB SF**.

The classification also introduces two new attributes entitled: Main-Group and Sub-Group, which categorise crimes by the possible social-economic-structural relationships.

Once a basic pre-1998 and post-1998 classification has been outlined, the researcher identified the need to fit Maltese crime categories within a wider-world construct that reflects both new crimes and a wider-base need for data at finer levels, as well as an internationally recognised structure.

This done, the next logical step would be to create a wider crime classification system to reflect the growing number of crime categories and the relevant sub-categories. In effect, following a review of the Police categories, the local prison sentence categories and a review of the UK-crime categories, a classification was created as part of this study. The process entailed the integration of the post-1997 Malta Crime categories to the UK crime categories, which classification would aid the Malta Police to further refine their data to reflect a wider crime context.

The methodology employed in this part of the study was based on a process where the Maltese categories were conciliated with the UK categories, mainly from the HMO list and the University of Huddersfield's Kirklees 4<sup>th</sup> Crime Audit. The list of Maltese crime categories and sub-categories was compared to the UK one and re-organised to reflect the wider-context UK one.

---

<sup>172</sup> <http://www.homeoffice.gov.uk/rds/recordedcrime1.html>

Offences pertaining to the local context as identified during the data gathering process at the Maltese Prison and as per the Police submissions, were included in the list.

Table A3-2 depicts the result through a Proposed Integrated Crime Classification Structure for the Maltese Islands that includes all potential crimes, with serious categories topping the list. Codifications are based on the initial sequence given to each different data source and the author's unique classification code. In conclusion the final Code would refer to that entitled: **UK CatB SF**.

The classification also introduces two new attributes entitled: Main-Group and Sub-Group, which categorise crimes by the possible social-economic-structural relationships.

Table A3-2: Proposed Integrated Crime Classification Structure for the Maltese Islands

Crime Categories - UK-Malta									
UK Code	MT Cat A	UK Cat A	Category (Huddersfield)	MT Cat B	UK Cat B SF	Sub-Category (Huddersfield - SF Amended for Malta)	Main Group	Sub-Group	
1	18A	1a	Homicide		1b	Murder	Violence against the person	Violence - Homicide	
4.1					1c	Manslaughter	Violence against the person	Violence - Homicide	
4.2					20A	Infanticide	Violence against the person	Violence - Homicide	
						1e	Other Homicide	Violence against the person	Violence - Homicide
						1f	Accomplice in wilful homicide	Violence against the person	Violence - Person
2		2a	Violence Against the Person	6E	2b	Attempted Murder	Violence against the person	Violence - Person	
					6C	2c	Attempted bodily harm	Violence against the person	Violence - Person
3						2d	Threats or conspiracy to murder	Violence against the person	Violence - Person
4.3					2e	Child destruction	Violence against the person	Violence - Person	
4.4					2f	Causing death by dangerous driving	Violence against the person	Violence - Person	
4.6					2g	Causing death by careless driving when under the influence of drinks or drugs	Violence against the person	Violence - Person	
37.1					2h	Causing death by aggravated vehicle taking	Violence against the person	Violence - Person	

Crime Categories - UK-Malta								
UK Code	MT Cat A	UK Cat A	Category (Huddersfield)	MT Cat B	UK Cat B SF	Sub-Category (Huddersfield - SF Amended for Malta)	Main Group	Sub-Group
					2i	Accomplice in attempted homicide	Violence against the person	Violence - Person
5		3a	Serious Wounding		3b	Wounding or Causing Grievous Bodily Harm with Intent (S18)	Violence against the person	Violence - Person
					3c	Accomplice in tentative grievous bodily harm	Violence against the person	Violence - Person
8A	8A	4a	Serious and Slight Wounding		4b	Malicious Wounding or Inflicting Grievous Bodily Harm (S20)	Violence against the person	Violence - Person
					4c	Slight wounding	Violence against the person	Violence - Person
				8B	4d	Domestic Violence	Violence against the person	Violence - Person
9		5a	Other Violence		5b	Assault occasioning Actual Bodily Harm (S47)	Violence against the person	Violence - Other
				26C	5c	Hold-Up	Violence against the person	Violence - Other
8C					5d	Harassment	Violence against the person	Violence - Other
				27A	5e	Threats and private violence	Violence against the person	Violence - Other
				3A	5f	Abuses relating to prison	Violence against the person	Violence - Other
8B					5g	Possession of weapons	Violence against the person	Violence - Other
6					5h	Endanger Railway Passengers	Violence against the person	Violence - Other
7					5i	Endanger Life at Sea	Violence against the person	Violence - Other
11					5j	Cruelty to or neglect of children	Violence against the person	Violence - Other
12					5k	Abandon Child under 2 Years	Violence against the person	Violence - Other
13					5l	Child Abduction	Violence against the person	Violence - Other
14				1A	5m	Procure Illegal Abortion /Miscarriage / Supply of poisonous substance	Violence against the person	Violence - Other

Crime Categories - UK-Malta								
UK Code	MT Cat A	UK Cat A	Category (Huddersfield)	MT Cat B	UK Cat B SF	Sub-Category (Huddersfield - SF Amended for Malta)	Main Group	Sub-Group
15					5n	Concealment of birth	Violence against the person	Violence - Other
				9A	5o	Concealment of bodies	Violence against the person	Violence - Other
8D					5p	Racially or Religiously aggravated other wounding	Violence against the person	Violence - Other
8E					5q	Racially or Religiously aggravated harassment	Violence against the person	Violence - Other
10					5r	Intimidation and molestation	Violence against the person	Violence - Other
					5s	Left wife/family in want	Violence against the person	Violence - Other
				8C	5t	General bodily harm (Other Assaults / Woundings)	Violence against the person	Violence - Other
					5u	Applied poisonous substance	Violence against the person	Violence - Other
					5v	Attempted Hold-Up	Violence against the person	Violence - Other
					5w	Attempted concealment of birth	Violence against the person	Violence - Other
					5x	Attempted abortion	Violence against the person	Violence - Other
105 A		6a	Common Assault		6b	Common assault (no injury) (S39)	Violence against the person	Violence - Common
104					6c	Assault/Resist Police Officer (constable)	Violence against the person	Violence - Common
				29A	6d	Violence against public officer	Violence against the person	Violence - Common
105 B					6e	Racially or Religiously aggravated common assault	Violence against the person	Violence - Common
16	25A	7a	Sexual Offences	6F	7b	Attempted sexual offence	Violence against the person	Violence - Sexual
					7c	Buggery	Violence against the person	Violence - Sexual
17					7d	Indecent Assault on Male	Violence against the person	Violence - Sexual
18					7e	Indecency between Males	Violence against the person	Violence - Sexual
19A					7f	Rape - Female	Violence against the person	Violence - Sexual



Crime Categories - UK-Malta								
UK Code	MT Cat A	UK Cat A	Category (Huddersfield)	MT Cat B	UK Cat B SF	Sub-Category (Huddersfield - SF Amended for Malta)	Main Group	Sub-Group
20					7g	Indecent Assault on Female	Violence against the person	Violence - Sexual
21					7h	Unlawful sexual intercourse with girl under 13	Violence against the person	Violence - Sexual
22					7i	Unlawful sexual intercourse with girl under 16/18	Violence against the person	Violence - Sexual
23					7j	Incest	Violence against the person	Violence - Sexual
24					7k	Procuration	Violence against the person	Violence - Sexual
25					7l	Abduction	Violence against the person	Violence - Sexual
26					7m	Bigamy/Adultery	Violence against the person	Violence - Sexual
				23A	7n	Prostitution	Violence against the person	Violence - Sexual
27					7o	Soliciting or importuning by a man	Violence against the person	Violence - Sexual
				4A	7p	Against morals/honour - Family	Violence against the person	Violence - Sexual
73					7q	Abuse of position of trust	Violence against the person	Violence - Sexual
74					7r	Gross indecency with a child	Violence against the person	Violence - Sexual
139					7s	Indecent Exposure	Violence against the person	Violence - Sexual
					7t	Accomplice in indecent assault	Violence against the person	Violence - Sexual
					7u	Aggravated indecent assault	Violence against the person	Violence - Sexual
					7v	Attempted gross indecency with a child	Violence against the person	Violence - Sexual
19B					7w	Rape - Male	Violence against the person	Violence - Sexual
					7x	General Sexual Offence	Violence against the person	Violence - Sexual
34B		10a	Robbery		10b	Robbery of the Person	Robbery	Violence - Robbery
34A					10c	Robbery of Businesses	Robbery	Violence - Robbery
					10d	Aggravated theft	Robbery	Violence - Robbery

Crime Categories - UK-Malta								
UK Code	MT Cat A	UK Cat A	Category (Huddersfield)	MT Cat B	UK Cat B SF	Sub-Category (Huddersfield - SF Amended for Malta)	Main Group	Sub-Group
					10e	Accomplice in Robbery (Aggravated theft)	Robbery	Violence - Robbery
					10f	Attempted aggravated theft	Robbery	Violence - Robbery
28		8a	Burglary Dwelling	26f	8b	Burglary in a dwelling (Theft from Residence)	Burglary	Burglary - Dwelling
29					8c	Aggravated burglary in a dwelling	Burglary	Burglary - Dwelling
					8d	Accomplice in Aggravated burglary in a dwelling	Burglary	Burglary - Dwelling
		9a	Burglary Other		9b	Burglary of Garages and Sheds	Burglary	Burglary - Other
						9c	Burglary of Commercial Premises	Burglary
				26H	9d	Theft from factories	Burglary	Burglary - Other
30					9e	Burglary in a building other than a dwelling	Burglary	Burglary - Other
31					9f	Aggravated burglary in a building other than dwelling	Burglary	Burglary - Other
32					9g	Entering with intent to commit felony	Burglary	Burglary - Other
37.2		11a	Vehicle Crime	26N	11b	Attempted Theft of/from a Vehicle	Theft	Theft - Vehicle
48						11c	Aggravated vehicle taking (TWLA)	Theft
					11d	Theft or unauthorised taking of motor vehicle	Theft	Theft - Vehicle
					11e	Theft of Commercial Vehicle	Theft	Theft - Vehicle
45				26L	11f	Theft from Vehicle	Theft	Theft - Vehicle
					11g	Theft from Commercial Vehicle	Theft	Theft - Vehicle
				26M	11h	Theft of seacraft	Theft	Theft - Seacraft
				26K	11i	Theft from seacraft	Theft	Theft - Seacraft
					11j	Aggravated theft from vehicle	Theft	Theft - Vehicle
					11k	Aggravated theft of seacraft	Theft	Theft - Seacraft

Crime Categories - UK-Malta									
UK Code	MT Cat A	UK Cat A	Category (Huddersfield)	MT Cat B	UK Cat B SF	Sub-Category (Huddersfield - SF Amended for Malta)	Main Group	Sub-Group	
126	26A	12a	Other Theft	6G	12b	Attempted theft	Theft	Theft - Other	
						12c	Vehicle interference and tampering	Theft	Theft - Other
37						12d	Embezzlement	Theft	Theft - Other
39						12e	Theft from Person	Theft	Theft - Other
40						12f	Theft from Dwelling (Theft in a dwelling other than from automatic machine or meter)	Theft	Theft - Other
42						12g	Theft or unauthorised taking from mail	Theft	Theft - Other
43						12h	Abstract Electricity	Theft	Theft - Other
44						12i	Theft of Pedal Cycle	Theft	Theft - Other
						12j	TWLA Pedal Cycle	Theft	Theft - Other
47						12k	Theft from automatic machines and meters	Theft	Theft - Other
					26D	12l	Pick-pocketing	Theft	Theft - Other
					26E	12m	Snatch and grab	Theft	Theft - Other
49					26B	12n	General theft (Other theft and unauthorised takings)	Theft	Theft - Other
						12o	Theft of Horses and Cattle, Animals	Theft	Theft - Other
54						12p	Handling stolen goods	Theft	Theft - Other
38						12q	Proceeds of crime	Theft	Theft - Other
					12r	Complicity in theft	Theft	Theft - Other	
46		13a	Theft from Shop, Retail, Leisure and Recreation Areas		13b	Theft from Shop	Theft	Theft - Retail	
					26F	13c	Theft from bars/hotels	Theft	Theft - Retail
					26G	13d	Theft from beaches	Theft	Theft - Retail
					26J	13e	Theft from retail outlets	Theft	Theft - Retail
41						13f	Theft by Employee	Theft	Theft - Retail
56	14A	14a	Criminal Damage	6D	14b	Attempted damage	Criminal damage	Criminal damage	
					6B	14c	Attempted arson	Criminal damage	Criminal damage
					5A	14d	Arson	Criminal damage	Criminal damage
59						14e	Threat or Possession with Intent to Commit Criminal Damage	Criminal damage	Criminal damage

Crime Categories - UK-Malta								
UK Code	MT Cat A	UK Cat A	Category (Huddersfield)	MT Cat B	UK Cat B SF	Sub-Category (Huddersfield - SF Amended for Malta)	Main Group	Sub-Group
					14f	Criminal Damage Endangering Life	Criminal damage	Criminal damage
52					14g	Setting fire to Crops , & c.	Criminal damage	Criminal damage
53					14h	Killing and Maiming Cattle	Criminal damage	Criminal damage
54					14i	Malicious Use, & c. of Explosives	Criminal damage	Criminal damage
55					14j	Destroying Ships	Criminal damage	Criminal damage
57					14k	Other Malicious Injuries	Criminal damage	Criminal damage
58A					14l	Criminal damage to a dwelling	Criminal damage	Criminal damage
58B					14m	Criminal damage to building other than dwelling	Criminal damage	Criminal damage
58C					14n	Criminal damage to a vehicle/ship	Criminal damage	Criminal damage
				14B	14o	Criminal damage by acid	Criminal damage	Criminal damage
				14C	14p	Criminal damage by explosion	Criminal damage	Criminal damage
				14D	14q	Criminal damage by paint	Criminal damage	Criminal damage
				14E	14r	Criminal damage by shot	Criminal damage	Criminal damage
				14G	14s	Hit and run	Criminal damage	Criminal damage
58D				14F	14t	General damage (Other criminal damage)	Criminal damage	Criminal damage
58E					14u	Racially or Religiously aggravated criminal damage to a dwelling	Criminal damage	Criminal damage
58F					14v	Racially or Religiously aggravated criminal damage to other building	Criminal damage	Criminal damage
58G					14w	Racially or Religiously aggravated criminal damage to a vehicle	Criminal damage	Criminal damage
58H					14x	Racially or Religiously aggravated other criminal damage	Criminal damage	Criminal damage

Crime Categories - UK-Malta									
UK Code	MT Cat A	UK Cat A	Category (Huddersfield)	MT Cat B	UK Cat B SF	Sub-Category (Huddersfield - SF Amended for Malta)	Main Group	Sub-Group	
					14y	Complicity in Criminal damage by explosion	Criminal damage	Criminal damage	
50		15a	Fraud and Forgery		15b	Obtaining by false pretences	Fraud and Forgery	Fraud and Forgery	
51					15c	Frauds by company directors	Fraud and Forgery	Fraud and Forgery	
52					15d	False accounting	Fraud and Forgery	Fraud and Forgery	
53					17A	15e	Other Frauds (government-related)	Fraud and Forgery	Fraud and Forgery
53A						15f	Cheque & credit card fraud	Fraud and Forgery	Fraud and Forgery
53B						15g	Other fraud	Fraud and Forgery	Fraud and Forgery
55						15h	Offences in Bankruptcy	Fraud and Forgery	Fraud and Forgery
58						15i	Forgery and Uttering (Felony)	Fraud and Forgery	Fraud and Forgery
59						15j	Forgery (Misdemeanour)	Fraud and Forgery	Fraud and Forgery
60						15k	Forgery or use of false drug prescriptions	Fraud and Forgery	Fraud and Forgery
61					16A	15l	Other forgery	Fraud and Forgery	Fraud and Forgery
61						15m	Uttering Counterfeit Coin	Fraud and Forgery	Fraud and Forgery
814						15n	Vehicle/driver document fraud	Fraud and Forgery	Fraud and Forgery
						15o	Complicity in fraud	Fraud and Forgery	Fraud and Forgery
						15p	Attempted fraud	Fraud and Forgery	Fraud and Forgery
					15q	Complicity in forgery	Fraud and Forgery	Fraud and Forgery	
92A	15A	16a	Drugs Offences		16b	Trafficking in controlled drugs	Drugs	Drugs	
92B					16c	Possession of controlled drugs	Drugs	Drugs	
92C						16d	Other drug offences	Drugs	Drugs






Crime Categories - UK-Malta									
UK Code	MT Cat A	UK Cat A	Category (Huddersfield)	MT Cat B	UK Cat B SF	Sub-Category (Huddersfield - SF Amended for Malta)	Main Group	Sub-Group	
					16e	Importation of dugs	Drugs	Drugs	
					16f	Complicity and conspiracy in possession and trafficking of drugs	Drugs	Drugs	
					16g	Cultivation of controlled drugs	Drugs	Drugs	
63		17a	Other Offences		17b	High Treason	Other	Other - State	
64					17c	Riot	Other	Other - State	
65					17d	Violent Disorder	Other	Other - State	
					10A	17e	Crimes against public peace (Disturbance)	Other	Other - State
					24A	17f	Safety of the government	Other	Other - State
					2A	17g	Abuse of public authority	Other	Other - State
66					11A	17h	Other offence against the state or public order	Other	Other - State
67					22A	17i	Perjury and false swearing	Other	Other - Justice
68						17j	Libel	Other	Other - Justice
69						17k	Bribery, Treating and undue influence	Other	Other - Justice
35					17l	Blackmail	Other	Other - Justice	
36					17m	Kidnapping	Other	Other - Justice	
71					17n	Escape and rescue	Other	Other - Justice	
					28A	17o	Violation of places of confinement	Other	Other - State
72					13A	17p	Other offences against public justice and the administration of justice (inc. recidivism)	Other	Other - Justice
					21A	17q	Malversation (Misconduct) by public officer	Other	Other - State
79					17r	Perverting the course of justice	Other	Other - Justice	
95					17s	Disclosure, Obstruction, False or Misleading Statements etc	Other	Other - Justice	
80					17t	Absconding from the lawful custody	Other	Other - Justice	
83					17u	Bail offences (inc. Probation, Conditional Discharge, Suspended Sentence, Art 12, 22, 23, Chap 152)	Other	Other - Justice	

Crime Categories - UK-Malta								
UK Code	MT Cat A	UK Cat A	Category (Huddersfield)	MT Cat B	UK Cat B SF	Sub-Category (Huddersfield - SF Amended for Malta)	Main Group	Sub-Group
78				19A	17v	Immigration offences	Other	Other - State
74					17w	Piracy	Other	Other - State
82					17x	Customs and Revenue offences	Other	Other - Financial
84					17y	Trade descriptions etc	Other	Other - Financial
75					17z	Betting, gaming, lotteries	Other	Other - Financial
				7A	17aa	Bankruptcy offences	Other	Other - Financial
85					17ab	Health and Safety offences	Other	Other - Health
89					17ac	Adulteration of food	Other	Other - Health
91					17ad	Public health offences	Other	Other - Health
				12A	17ae	Crimes against religious sentiment	Other	Other - Sentiment
73					17af	Blasphemy	Other	Other - Sentiment
86					17ag	Obscene publications, gestures	Other	Other - Sentiment
94					17ah	Planning and environment laws	Other	Other - State
87					17ai	Protection from eviction	Other	Other - State
81					17aj	Firearms Acts offences	Other	Other - State
90					17ak	Sharp Instrument offences (UK = Knives Act 1997 offences )	Other	Other - State
33					17al	Going equipped for stealing, etc.	Other	Other - State
802					17am	Dangerous driving	Other	Other - Transport
					17an	Traffic offences	Other	Other - Transport
					17ao	Driving without a licence	Other	Other - Transport
76					17ap	Aiding suicide	Other	Other - Health
77					17aq	Poaching/hunting/trapping related	Other	Other - State
					17ar	Illegal arrest/detention	Other	Other - Justice
					17as	Drunkness	Other	Other - Health
					17at	Kept a brothel	Other	Other - Sentiment

Crime Categories - UK-Malta								
UK Code	MT Cat A	UK Cat A	Category (Huddersfield)	MT Cat B	UK Cat B SF	Sub-Category (Huddersfield - SF Amended for Malta)	Main Group	Sub-Group
					17au	Immoral/obscene words	Other	Other - Sentiment
					17av	Abandoned ship	Other	Other - State
					17aw	Accomplice in escape from prison	Other	Other - Justice
					17ax	Electoral offences	Other	Other - State
					17ay	Begging	Other	Other - Financial
					17az	Education offences (absent from school)	Other	Other - Educational
					17aaa	Complicity in blackmail, etc	Other	Other - Justice
					17aab	Complicity in bribery	Other	Other - Justice
					17aac	Conversion of Multa/Ammenda/Fine/Referree's fees(Court Expert)	Other	Other - Justice
					17aad	Corruption of athlete	Other	Other - Sports
					17aac	Corruption of Public officer	Other	Other - State
					17aaf	Corruption of witness	Other	Other - Justice
					17aag	Cruelty to animals	Other	Other - Creatures
					17aah	Debtor's Arrest on Demand by Other Party	Other	Other - Financial
					17aai	Desertion	Other	Other - State
					17aaj	Trespassing, entering property without permission, entering restricted area	Other	Other - State
					17aak	Illegal assembly	Other	Other - State
					17aal	White slave traffic	Other	Other - State
					17aam	Computer misuse	Other	Other - Justice
99					17aaz	Other indictable offences	Other	Other
	6A	18a	Attempted offences		18b	Other attempted offences (other than 2b, 2c, 7b, 11b, 12b ,14b, and 14c)	Attempted	Attempted
					18c	Attempted bribery	Attempted	Attempted
					18d	Attempted corruption of Public officer	Attempted	Attempted
					18e	Attempted corruption of athlete	Attempted	Attempted – Sports



Crime Categories - UK-Malta								
UK Code	MT Cat A	UK Cat A	Category (Huddersfield)	MT Cat B	UK Cat B SF	Sub-Category (Huddersfield - SF Amended for Malta)	Main Group	Sub-Group
					18f	Attempted escape from prison	Attempted	Attempted
					18g	Attempted Illegal arrest/detention	Attempted	Attempted
					18h	Attempted to drive a car without permission	Attempted	Attempted
		19a	Missing Data		19b	Cancelled/blank/deleted	Missing Data	Missing Data
					19c	Duplicate	Missing Data	Missing Data

Key	
	new SF (as per Malta prison data)
	added text to the UK (HMO) list
	new from Malta list
	Huddersfield Audit but not in HMO list
	Malta list has both "Infanticide/Abandonment of Child" which in HMO list are separate. HMO list is taken as a default
	a = UK main category
	d to zz = UK sub-categories
	A = Malta main category
	B to ZZ = Malta sub-categories

## Appendix 4: Metadata

Sample of Tables depicting the datasets used for the study:

Appendix 4 lists the Metadata and describes the sample content of one dataset, listing coverage, currency, attributes, format and status.

<b>Dataset No.</b>	<b>1</b>	
File Name	absjust_1949-1999.xls	
Path	C:\studio\workarea saviour\PhD Env Crime 2002\data\crime data\abstract of statistics crime	
Description	Crimes from 1949-1999 - general data aggregates at national level	
Temporal	1949-1999	
Format	xls	
Coverage	national	
Attributes	1. Number of cases introduced and disposed of	1. Pending, Introd., Disp. Of, by Court type
<i>Sub Attributes</i>	2. Number of persons tried, and results of proceeding in the criminal courts	2. Sex, Offence type by disposal type
	3. Offences committed by juveniles	3. Sex, age, offence type, disposal type
	4. Criminal cases decided	4. Sex, age, offence type, disposal type
	5. Prison inmates	5. Sex, age, recidivism, sentence type
	6. Crimes known to the police	6. Offence type
Dataset status	to input data from 1949 - 1976	
<b>Dataset No.</b>	<b>2</b>	
File Name	crimes of the century.XLS	
Path	C:\studio\workarea saviour\PhD Env Crime 2002\data\crime data\crimes of the century data	
Description	Offender data from 1950-1999 - individual incarcerated offender at address point level	
Temporal	1950-1999	
Format	xls	
Coverage	address point	
Attributes	Category	
<i>Sub Attributes</i>	Unique Prisoner No.	
	SF Inmate Code Alphabetical	
	Prisoner No. SF	
	Prisoner Code (CCF)	
	Offence Code (1990s)	
	Prisoner Surname	
	Prisoner Name	
	Date of sentence (Last Date)	
	Date of sentence (Other Dates)	
	Date of reception (Earliest Date) 1st run	
	Date of reception (Earliest Date)	
	Date of reception (Other Dates)	

<b>Dataset No.</b>	<b>2</b>	
	Court Delivering Sentence	
	Conviction Ticket Number	
	Offence	
	Arrived from (foreign incoming to Malta)	
	Offence Location	<i>Address1</i>
		<i>Address2</i>
		<i>Location</i>
	Time of Offence	
	Sentence	<i>Original Sentence (Ammenda/Multa) (except where stated the sentence is converted into imprisonment) Sentences with Multa/Ammenda plus Imprisonment as indicated herein)</i>
		<i>Converted to Imprisonment (day/s)</i>
		<i>years</i>
		<i>months</i>
		<i>weeks</i>
		<i>days</i>
		<i>Total (days)</i>
		<i>Type</i>
	When Discharged (Date)	
	When Discharged (Info)	
	Convictions	<i>First Offender</i>
		<i>Recidivist</i>
		<i>Ex-Approved Schoolboy (Art: 23 CC) or Probation</i>
		<i>f-r Convictions</i>
	Particulars	<i>Nickname</i>
		<i>Age (Years-Months)</i>
		<i>Age (Years) 1st run</i>
		<i>Age (Years)</i>
		<i>Profession</i>
		<i>Place of Birth</i>
		<i>Place of Birth (Country for foreigners) 1st run</i>
	Place of Birth (Country for foreigners)	
		<i>Address1</i>
		<i>Address2</i>
		<i>Residence (Country for foreigners) 1st run</i>
		<i>Address1</i>
		<i>Address2</i>
		<i>Residence (Country for foreigners)</i>
		<i>Single, Married or Widower</i>
		<i>Number of Children</i>
	Description	<i>Height (ft and m)</i>
		<i>Height (m)</i>
		<i>Weight</i>
		<i>Weight (kg)</i>
		<i>Hair</i>

<b>Dataset No.</b>	<b>2</b>	
		<i>Eyes</i>
		<i>Complexion</i>
		<i>Appearances (Tattooed)</i>
		<i>Appearances (Marks)</i>
	Education	<i>Read</i>
		<i>Write</i>
		<i>School Attended</i>
		<i>Highest Class Attended</i>
		<i>Literacy Level</i>
		<i>School Type</i>
	Religious Denomination	
	Nationality	
	Father's Name	
	Father's Residence	
	Mother's maiden name and surname	
	Father's Name	
	Father's Residence	
	Mother's maiden name and surname	
	Spouse's name and surname	
	Remarks	<i>Remarks 1</i>
		<i>Remarks 2</i>
		<i>Remarks 3</i>
		<i>Remarks 4</i>
		<i>Remarks 5</i>
		<i>Remarks 6</i>
	Additional Sentence Inputs	
	ID Card	
	Multa/Ammenda	<i>Paid Multa/Ammenda</i>
	Sentence Adjustments	<i>Removal Order</i>
		<i>Sentence altered by Appeals Court (a = acquitted, i = increased, r = reduced, c = original sentence confirmed)</i>
		<i>Arrest period considered and deducted from sentence (y = arrest period deducted, r = sentence already served by period under arrest)</i>
		<i>Warrant/DOP Order/Court Order/Authority (b = Benefitted, r = Released)</i>
	Amnesty (b = Benefitted, r = Released)	
	Misdemeanors in prison	
	Register Title	
	SubTitle	
	Period Start	
	Period End	
	Other Data	
Dataset status	to clean all dataset attributes and recode attributes such as sentences to fit new police crime categories	

<b>Dataset No.</b>	<b>3</b>	
File Name	POL001.XLS	
Path	C:\studio\workarea saviour\PhD Env Crime 2002\data\crime data\educ data	
Description	Education citations for non-attendance by school - by locality	
Temporal	October 2000 - May 2001	
Format	xls	
Coverage	school-locality, student-address point	
Attributes	L/C	
	Ref / Date	
	Parent	
	Student	
	School	
	Class	
	Address	
	Locality	
	D.O.B	
	Oct	
	Nov	
	Dec	
	Jan	
	Feb	
	Mar	
	Apr	
	May	
	Jun	
Dataset status	to review data for the 2000-2001 scholastic year	
<b>Dataset No.</b>	<b>4</b>	
File Names	OCTOBER 2000.xls - MAY 2001.xls	
Path	C:\studio\workarea saviour\PhD Env Crime 2002\data\crime data\educ data	
Description	Education citations for non-attendance by school - by student by home and school address	
Temporal	October 2000 - May 2001	
Format	xls	
Coverage	school-locality, student-address point	
Attributes	Contravention No	
	Date Issued	
	Evidence Details	
	Student Name	
	Date of Birth	
	Gender	
	Name	
	Surname	
	Add1	

<b>Dataset No.</b>	<b>4</b>	
	Add2	
	Add3	
	School Name 1	
	School Name 2	
	StreetName	
	Locality	
Dataset status	to review data for the 2000-2001 scholastic year	
<b>Dataset No.</b>	<b>5</b>	
File Name	police crime crm98-03.TAB	
Path	C:\studio\workarea saviour\PhD Env Crime 2002\data\crime data\Police data	
Description	Education citations for non-attendance by school - by locality	
Temporal	1998 - 2003	
Format	TAB	
Coverage	address point, street	
Attributes	RowID_Unique	
	Police_Code	
	Day	
	Month	
	Year	
	Date	
	Hours	
	Minutes	
	Time	
	Crime_Category	
	Crime_Sub_Category	
	Building_Address1	
	Street_Address2	
	Sub_Locality	
	Locality	
Dataset status	to georeference	
<b>Dataset No.</b>	<b>6</b>	
File Names	ADDRESS.TAB	
Path	C:\studio\workarea saviour\PhD Env Crime 2002\data\gis data\landuse\address	
Description	address point database for buildings in the Maltese Islands	
Temporal	1995	
Format	tab	
Coverage	address point	
Attributes	Dwellings	<i>House</i>
<i>Sub Attributes</i>		<i>Appartments</i>

<b>Dataset No.</b>	<b>6</b>	
		<i>Residence</i>
		<i>Farmhouse</i>
		<i>Boat House</i>
	Commercial	<i>Company</i>
		<i>Market</i>
	Educational	<i>School</i>
		<i>Library</i>
		<i>Museum</i>
		<i>Learning Centre</i>
	Administration	<i>Government Building</i>
		<i>Embassy</i>
		<i>Ministry / Parliament</i>
		<i>Corporation/Authority</i>
		<i>Local Council</i>
		<i>Justice Courts</i>
	Financial	<i>Bank</i>
		<i>Exchange</i>
		<i>Trade Fairs</i>
		<i>Lotto Office</i>
	Health	<i>Hospital</i>
		<i>Pharmacies</i>
		<i>Clinics / Polyclinics</i>
		<i>Blood Bank</i>
		<i>Addiction Centre</i>
		<i>Public Convenience</i>
		<i>Animal Welfare</i>
		<i>Inspectorate</i>
	Social Clubs	<i>Political Club</i>
		<i>Youth Centre</i>
		<i>Band Club</i>
		<i>Civic Centre / Scouts</i>
		<i>Elderly Centre</i>
		<i>Sports Club</i>
		<i>Hobby Club / Club</i>
		<i>Union</i>
	Religious	<i>Places of Worship Maltese</i>
		<i>Places of Worship Foreign</i>
		<i>Cemetery</i>
		<i>Church Centre / Administration / MUSEUM</i>
		<i>Convents</i>
		<i>Home for Children etc</i>
		<i>Home for the Elderly</i>
	Historic Buildings	<i>Archaeology</i>
		<i>Castles / Battery</i>
	Security	<i>Police Academy</i>
		<i>Police Station</i>
		<i>Fire Station</i>

<b>Dataset No.</b>	<b>6</b>	
		<i>Customs</i>
		<i>Prison</i>
		<i>Army</i>
		<i>Private Security</i>
	Infrastructure	<i>Electricity</i>
		<i>Water</i>
		<i>Fuel Station</i>
		<i>Communications</i>
		<i>Transport</i>
		<i>Drainage</i>
		<i>Post</i>
		<i>Ports / Airports</i>
		<i>Agriculture / Fisheries</i>
	Recreation / Tourism	<i>Garden</i>
		<i>Playground</i>
		<i>Caravan site</i>
		<i>Hall / Stores</i>
		<i>Guest House / Holiday Centre / Hotel</i>
		<i>Stable</i>
		<i>Theatre</i>
	Professional Services	<i>Lawyer / Notary</i>
		<i>Office / Institute</i>
		<i>Store</i>
		<i>Other</i>
Dataset status	cleaned	



## Appendix 5: Lineage - Geocoding crime data for the Maltese Islands

---

**Project:** Geocoding crime data for the Maltese Islands– Version 5

**User:** Saviour Formosa

**Date:** 05 September 2004

**Source File Name:** Geocoding crime data for the Maltese Islands.doc

**Destination Directory:** C:\Valhalla\saver\research\crime\lineage

**Project Description:** Creation of a MapInfo data layer containing all geocoded crime points from the Offender and Offence datasets and the police crime dataset. All the procedures are covered and give an extensive review of the whole process

**Abbreviations used:**

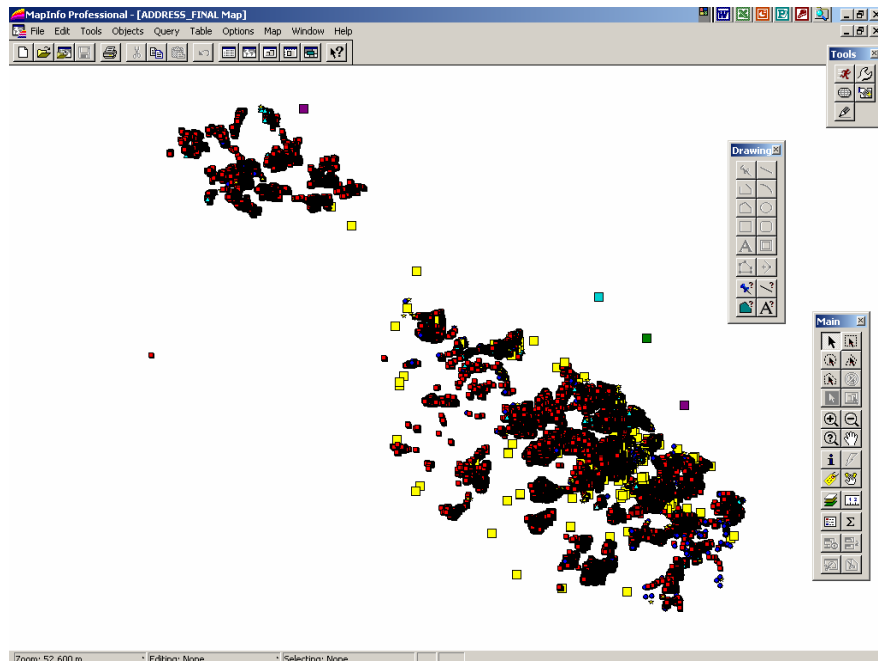
xls	Excel file
doc	Word file
tab	MapInfo file
mif/mid	MapInfo Export file
dbf	Database format file

---

### Lineage Steps

Phases

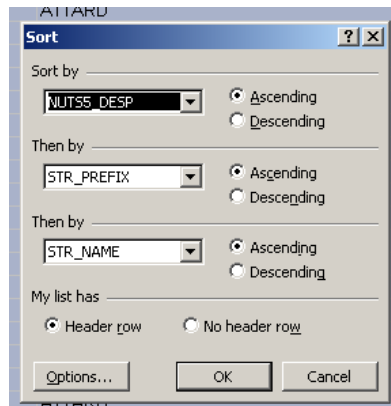
1. Phase 1: main tables editing
  2. Address point database
    - a. manual inputting new street names and address points in ADDRESS\_FINAL.TAB



- i. edited **council\_centroids\_final\_no\_XY.TAB**, moved centroid to approximate built-up centre and saved as **council\_centre\_nodes.TAB**
- b. Address point database
  - i. Checked the address data in **RESLOC21AUG2004.xls**
    1. Sorted by Council, Prefix, Street name



2. Opened **streets for crime.TAB** and exported as **streets for crime\_check.DBF**
3. Opened **streets for crime\_check.DBF** in Excel and sorted by NUTS5\_DESP, STR\_PREFIX, STR\_NAME. Saved as **streets for crime\_check.xls**



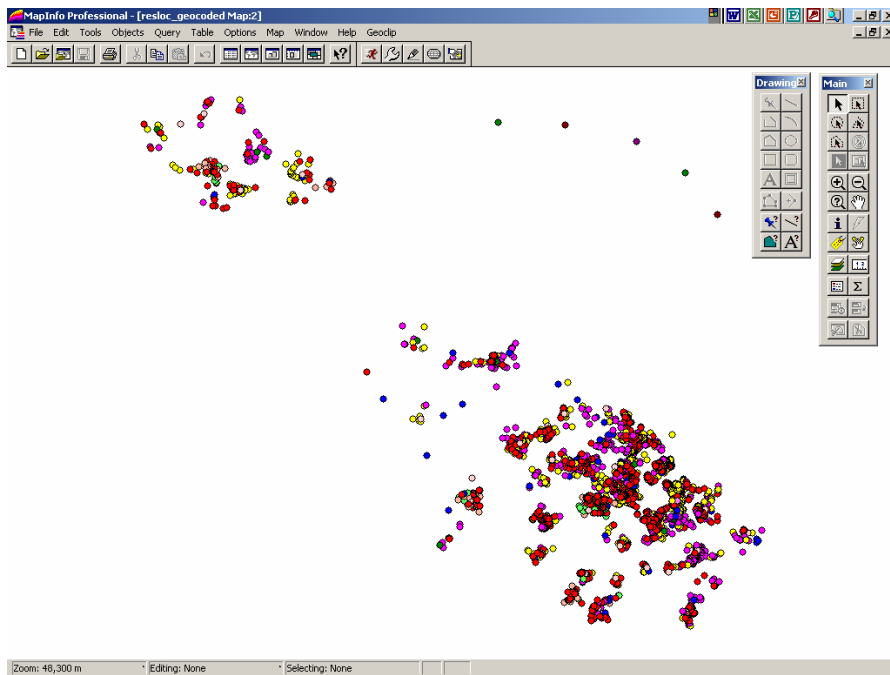
4. Edited **RESLOC21AUG2004.xls** as per the street names in the georeferenced **streets for crime.TAB** through the sorted **streets for crime\_check.xls** (noted new streets to be inserted in the original streets dataset that were either misspelt or were not present)
5. Updated the Add\_Concat column using the formula to extract a full street address (=C2&" "&D2&" "&B2&" "&E2)
6. Copied and pasted the resultant column into a text only column named Add\_Concat\_text\_only, which will be used for the geocoding function

RESLOC21AUG2004.xls [Read-Only]				streets for crime_check.xls [Read-Only]				
1	Res_Add2_str2	Res_Add3	Malta_LC	Add_Concat	A	B	C	
4901	SAN PIETRU 4	QORMI	10	SQAQ SAN PIETRU 4, Q	12541	MISRAH	MATTIA PRETI	ZURRIEQ
4902	PINTO	QORMI	2	TRIQ PINTO, QORMI	12542	MISRAH	SAN LAZZRU	ZURRIEQ
4903	PINTO	QORMI	8	TRIQ PINTO, QORMI	12543	MISRAH	SANTA MARIJA	ZURRIEQ
4904	PINTO	QORMI	8	TRIQ PINTO, QORMI	12544	MISRAH IL	KARMELETANI	ZURRIEQ
4905	PINTO	QORMI	8	TRIQ PINTO, QORMI	12545	MISRAH IR	REPUBBLIKA	ZURRIEQ
4906	PINTO	QORMI	12	TRIQ PINTO, QORMI	12546	SQAQ	ALESSANDRU	ZURRIEQ
4907	PINTO	QORMI	15	TRIQ PINTO, QORMI	12547	SQAQ	BALLOTT	ZURRIEQ
4908	PINTO	QORMI	35	TRIQ PINTO, QORMI	12548	SQAQ	BARCELLONA	ZURRIEQ
4909	PINTO	QORMI	35	TRIQ PINTO, QORMI	12549	SQAQ	BARCELLONA	ZURRIEQ
4910	PINTO	QORMI	82	TRIQ PINTO, QORMI	12550	SQAQ	FRANZINA	ZURRIEQ
4911	PINTO	QORMI	82	TRIQ PINTO, QORMI	12551	SQAQ	SAN ANARD	ZURRIEQ
4912	PINTO	QORMI	82	TRIQ PINTO, QORMI	12552	SQAQ	SAN BARTILMEW NRU. 2	ZURRIEQ
4913	PINTO	QORMI	82	TRIQ PINTO, QORMI	12553	SQAQ	SAN CIRU	ZURRIEQ
4914	PINTO	QORMI	100	TRIQ PINTO, QORMI	12554	SQAQ	SAN EDWARDU	ZURRIEQ
4915	PINTO	QORMI	100	TRIQ PINTO, QORMI	12555	SQAQ	SAN GAKMU	ZURRIEQ
4916	PINTO	QORMI	146	TRIQ PINTO, QORMI	12556	SQAQ	SAN GUZEPP	ZURRIEQ
4917	PINTO	QORMI	150	TRIQ PINTO, QORMI	12557	SQAQ	SAN GWANN	ZURRIEQ
4918	PINTO	QORMI	152	TRIQ PINTO, QORMI	12558	SQAQ	SAN KRISTOFRU	ZURRIEQ
4919	PINTO	QORMI	170	TRIQ PINTO, QORMI	12559	SQAQ	SAN LAWRENZ	ZURRIEQ
4920	PINTO	QORMI	170	TRIQ PINTO, QORMI	12560	SQAQ	SAN LEOPOLDU	ZURRIEQ
4921	PINTO	QORMI		St. Mary House, TRIQ PINTO	12561	SQAQ	SAN MARTIN	ZURRIEQ
4922	Qormi			Flat 1, Blk XI, , Qormi	12562	SQAQ	SAN MARTIN	ZURRIEQ
4923	HAL-QORMI	QORMI	33	TRIQ HAL-QORMI, QORI	12563	SQAQ	SAN MIKIEL	ZURRIEQ
4924	SAN RAFEL	QORMI	9	TRIQ SAN RAFEL, QORM	12564	SQAQ	SAN MIKIEL NRU. 1	ZURRIEQ
4925	SAN RAFEL	QORMI	65	TRIQ SAN RAFEL, QOR	12565	SQAQ	SAN MIKIEL NRU. 1	ZURRIEQ
4926	SAN RAFEL	QORMI	72	TRIQ SAN RAFEL, QOR	12566	SQAQ	SAN MIKIEL, NRU. 5	ZURRIEQ
4927	SAN RAFEL	QORMI	17	TRIQ SAN RAFEL, QOR	12567	SQAQ	SAN PATRIZJU	ZURRIEQ
4928	IL-BLATA	QORMI	31	TRIQ IL-BLATA, QORMI	12568	SQAQ	SANT' ANDRIJA	ZURRIEQ
4929	IL-BLATA	QORMI	66	TRIQ IL-BLATA, QORMI	12569	SQAQ	SANT' ANTININ	ZURRIEQ
4930	IL-BLATA	QORMI	69	TRIQ IL-BLATA, QORMI	12570	SQAQ IL-	BIZZILLA	ZURRIEQ
4931	IL-BLATA	QORMI	69	TRIQ IL-BLATA, QORMI	12571	SQAQ IL-	FJURI	ZURRIEQ
4932	ROSSA	QORMI	21	TRIQ ROSSA, QORMI	12572	SQAQ IL-	FNIEK	ZURRIEQ
					12573	SQAQ IL-	HELU	ZURRIEQ
					12574	SQAQ IL-	KAPMNI I NDI 1	ZURRIEQ
					12575	SQAQ IL-	71 IDDIFQ	ZURRIEQ

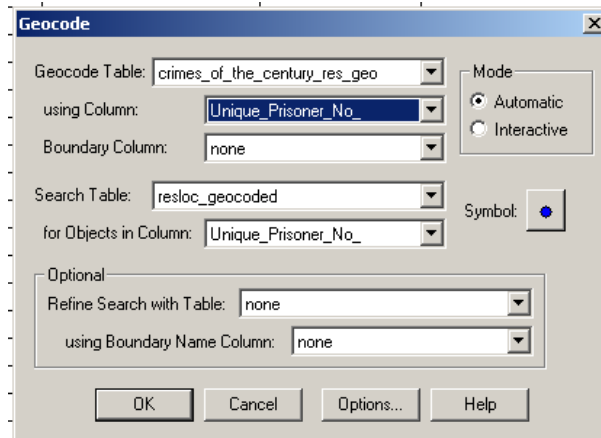
1. open RESLOC21AUG2004.xls in MapInfo and save as RESLOC21AUG2004.TAB

...

*Process is shortened at this stage – full lineage is 46 pages long..... final part of process continues below*



3. Phase 8: To geocode a series of crime point maps based on the results of the above geocoding processes:
  - a. Part1: Geocoding the original input table, based on the residential location: **crimes of the century sep2004.XLS**
    - i. Opened files **crimes of the century sep2004.XLS** and **resloc\_geocoded.TAB**
    - ii. Geocoded on Unique\_Prisoner\_No\_ (indexed field) – **BLUE** points



- iii. Saved as **crimes of the century.TAB**. Added an attribute named GeoCode\_Location and inserted the codes created through the geocoding process in the Phases above, mainly:
  1. Aboard Ship
  2. Foreign
  3. Homeless
  4. Malta (all located addresses)
  5. No fixed address
  6. Unknown

Count	GeoCode_location
71	Aboard Ship
499	Foreign
257	Homeless
7,384	Malta
44	No fixed address
141	Unknown

- iv. Saved final residential location table as **crimes of the century\_res\_geo.TAB**.
- b. Part1: Geocoding the original input table, based on the offence location – 1<sup>st</sup> to 24<sup>th</sup> instances:
  - i. Copied all the **offences\_only\_unique\_X\_final.TAB** tables into C:\studio\workarea saviour\PhD Env Crime 2004\data\crime data\crimes of the century data and renamed as **off\_geo\_X.TAB**

- ii. Left each table as a separate entity in order to allow later joining with the residential table during the analysis phase. Color-coded each instance in different colours

c. Resume: Total geocoded points in residential and offence locations:

Table	Points
res_geo	8396
off_geo_1	2154
off_geo_2	146
off_geo_3	68
off_geo_4	33
off_geo_5	19
off_geo_6	13
off_geo_7	12
off_geo_8	8
off_geo_9	8
off_geo_10	5
off_geo_11	3
off_geo_12	3
off_geo_13	2
off_geo_14	2
off_geo_15	2
off_geo_16	2
off_geo_17	2
off_geo_18	2
off_geo_19	2
off_geo_20	2
off_geo_21	2
off_geo_22	2
off_geo_23	2
off_geo_24	2
<b>Total</b>	<b>10892</b>

**Note 1:** Address attribute update queries: **Offloc\_unique table.TAB fulladd\_X\_1<sup>st</sup>** attribute

```

OfcLocAdd1__2__2+" "+OfcLocAdd2__2__2+", "+ OfcLocAdd1__2_+", "+OfcLocAdd3__2__2
OfcLocAdd1__3__2+" "+OfcLocAdd2__3__2+", "+ OfcLocAdd1__3_+", "+OfcLocAdd3__3__2
OfcLocAdd1__4__2+" "+OfcLocAdd2__4__2+", "+ OfcLocAdd1__4_+", "+OfcLocAdd3__4__2
OfcLocAdd1__5__2+" "+OfcLocAdd2__5__2+", "+ OfcLocAdd1__5_+", "+OfcLocAdd3__5__2
OfcLocAdd1__6__2+" "+OfcLocAdd2__6__2+", "+ OfcLocAdd1__6_+", "+OfcLocAdd3__6__2
OfcLocAdd1__7__2+" "+OfcLocAdd2__7__2+", "+ OfcLocAdd1__7_+", "+OfcLocAdd3__7__2
OfcLocAdd1__8__2+" "+OfcLocAdd2__8__2+", "+ OfcLocAdd1__8_+", "+OfcLocAdd3__8__2
OfcLocAdd1__9__2+" "+OfcLocAdd2__9__2+", "+ OfcLocAdd1__9_+", "+OfcLocAdd3__9__2
OfcLocAdd1__10__2+" "+OfcLocAdd2__10__2+", "+ OfcLocAdd1__10_+", "+OfcLocAdd3__10__2
OfcLocAdd1__11__2+" "+OfcLocAdd2__11__2+", "+ OfcLocAdd1__11_+", "+OfcLocAdd3__11__2
OfcLocAdd1__12__2+" "+OfcLocAdd2__12__2+", "+ OfcLocAdd1__12_+", "+OfcLocAdd3__12__2
OfcLocAdd1__13__2+" "+OfcLocAdd2__13__2+", "+ OfcLocAdd1__13_+", "+OfcLocAdd3__13__2
OfcLocAdd1__14__2+" "+OfcLocAdd2__14__2+", "+ OfcLocAdd1__14_+", "+OfcLocAdd3__14__2
OfcLocAdd1__15__2+" "+OfcLocAdd2__15__2+", "+ OfcLocAdd1__15_+", "+OfcLocAdd3__15__2
OfcLocAdd1__16__2+" "+OfcLocAdd2__16__2+", "+ OfcLocAdd1__16_+", "+OfcLocAdd3__16__2

```

### **Comments on difficulties**

- i) *Malta has no real address point database (first and last one was created in 1995 and has yet to be updated)*
- ii) *A street database exists but it does not incorporate addresses.*
- iii) *In view of this, a series of steps were developed that helped create a crime point database*
- iv) *Address names are very difficult to compare at diverse levels:*
  - a. *Names can be in English or Maltese*
  - b. *Street names are changed or new ones given names such as New Street in...*
  - c. *Different datasets have different names such as address point database, streets all, prison data, police data*

## **Appendix 6: UN Crime Definition and Malta in Europe and in islands Perspectives**

**i) Crime definitions** based on the United Nations (2003) InstrumentE (questionnaire) extract

**ii) Crime Maps: Malta in Europe and Islands perspectives**

(Graduated Maps with labelled crimes per 1000 persons)

**i) Crime definitions based on the United Nations (2003) InstrumentE (questionnaire) extract  
(Pages 5-6)**

UNITED NATIONS  
UNIES



NATIONS

**Definition of terms**

1. The definitions below are applicable to many legal codes.
2. “*Intentional homicide*” may be understood to mean death deliberately inflicted on a person by another person, including infanticide.
3. “*Non-intentional homicide*” may be understood to mean death not deliberately inflicted on a person by another person. That includes the crime of manslaughter but excludes traffic accidents that result in the death of persons.
4. “*Assault*” may be understood to mean physical attack against the body of another person, including battery but excluding indecent assault. Some criminal or penal codes distinguish between aggravated assault and simple assault, depending on the degree of resulting injury. If such a distinction is made in your country, please provide the relevant data for aggravated assault under the category “Major assault”. Under the category “Total assault” should be included data on both aggravated assault (i.e. major assault) and simple assault. Please provide the main criterion for distinguishing between aggravated assault and simple assault if such a distinction is made in your country.
5. “*Rape*” may be understood to mean sexual intercourse without valid consent. Please indicate whether statutory rape is included in the data provided. If, in your country, a distinction is made between sexual assault and actual penetration, please provide relevant information.
6. “*Robbery*” may be understood to mean the theft of property from a person, overcoming resistance by force or threat of force.
7. “*Theft*” may be understood to mean the removal of property without the property owner’s consent.  
“Theft” excludes burglary and housebreaking as well as theft of a motor vehicle. Some criminal and penal codes distinguish between grand and petty theft, depending on the value of the goods and property taken from their rightful owner. If such a distinction is made in your country, please provide the relevant data for grand theft under the category “Major theft”. The category “Total theft” should include data on both grand theft (i.e. major theft) and petty theft. Please provide the main criterion for distinguishing between grand theft and petty theft if such a distinction is made in your country.
8. “*Automobile theft*” may be understood to mean the removal of a motor vehicle without the consent of the owner of the vehicle.
9. “*Burglary*” may be understood to mean unlawful entry into someone else’s premises with the intention to commit a crime.
10. “*Fraud*” may be understood to mean the acquisition of another person’s property by deception. Please indicate whether the fraudulent obtaining of financial property is included in the data provided.
11. “*Embezzlement*” may be understood to mean the wrongful appropriation of another person’s property that is already in the possession of the person doing the appropriating.
12. “*Drug-related crimes*” may be understood to mean intentional acts that involve the cultivation, production, manufacture, extraction, preparation, offering for sale, distribution, purchase, sale, delivery on any terms whatsoever, brokerage, dispatch, dispatch in transit, transport, importation, exportation and possession of internationally controlled drugs. Where applicable, reference may be made to the provisions of the Single Convention on Narcotic Drugs of 1961<sup>1</sup> and other regulations adopted in pursuance of the provisions of the Convention on Psychotropic Substances of 1971<sup>2</sup> and/or the United Nations Convention against Illicit Traffic in Narcotic Drugs and Psychotropic Substances



of 1988.<sup>3</sup>

13. “*Bribery and/or corruption*” may be understood to mean requesting and/or accepting material or personal benefits, or the promise thereof, in connection with the performance of a public ~~function for~~

<sup>1</sup> United Nations, *Treaty Series*, vol. 520, No. 7515.

<sup>2</sup> *Ibid.*, vol. 1019, No. 14956.

<sup>3</sup> *Official Records of the United Nations Conference for the Adoption of a Convention against Illicit Traffic in Narcotic Drugs and Psychotropic Substances, Vienna, 25 November-20 December 1988*, vol. I (United Nations publication, Sales No. E.94.XI.5).

UNITED NATIONS  
UNIES



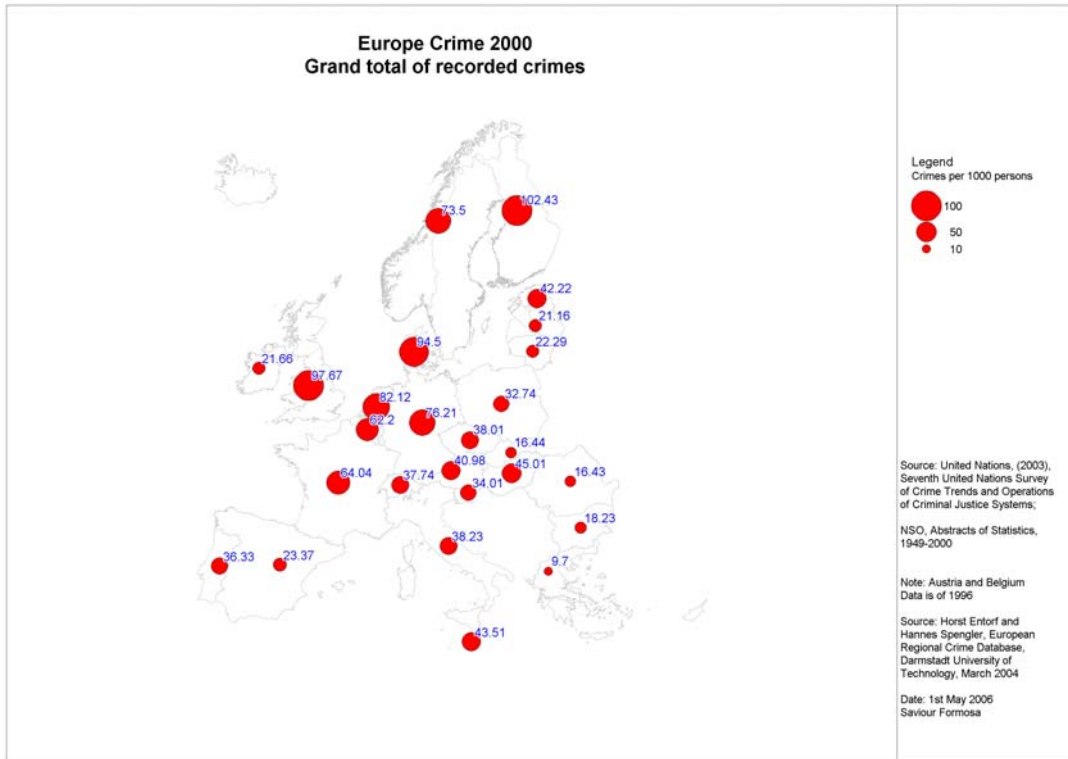
NATIONS

an action that may or may not be a violation of law and/or promising as well as giving material or personal benefits to a public officer in exchange for a requested favor.

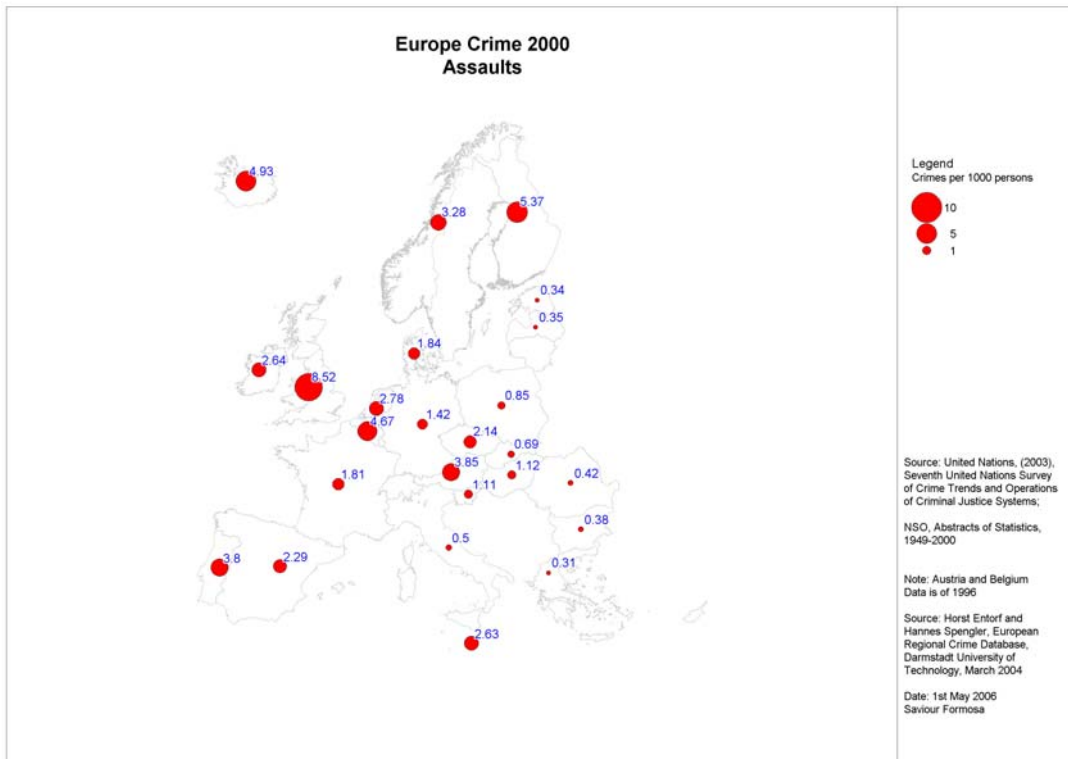
14. “*Recorded crimes*” may be understood to mean the number of penal code offences or their equivalent (i.e. various special law offences), but excluding minor road traffic offences and other petty offences, brought to the attention of the police or other law enforcement agencies and recorded by one of those agencies.
15. “*Police personnel or law enforcement personnel*” may be understood to mean personnel in public agencies whose principal functions are the prevention, detection and investigation of crime and the apprehension of alleged offenders. If the police are part of the national security force in your country, please try to focus your replies as much as possible on the civil police rather than on the national guard or local militia. If there are many local forces, please provide data on those forces if possible. If police or law enforcement personnel fulfill prosecutorial functions, that fact should be noted in the space below table 1. Data concerning support staff (secretaries, clerks etc.) should be excluded from your replies.
16. If the categories given in paragraphs 2-13 above are not fully compatible with the legal code in your country, please try to adjust the data as far as possible. Alternatively, you may indicate in the space below the table concerned or on the facing page what kinds of crime are included in your statistics that might be comparable to the categories suggested or how the comparable types of crime are defined in your country.

## ii) Crime maps: Malta in Europe Perspective

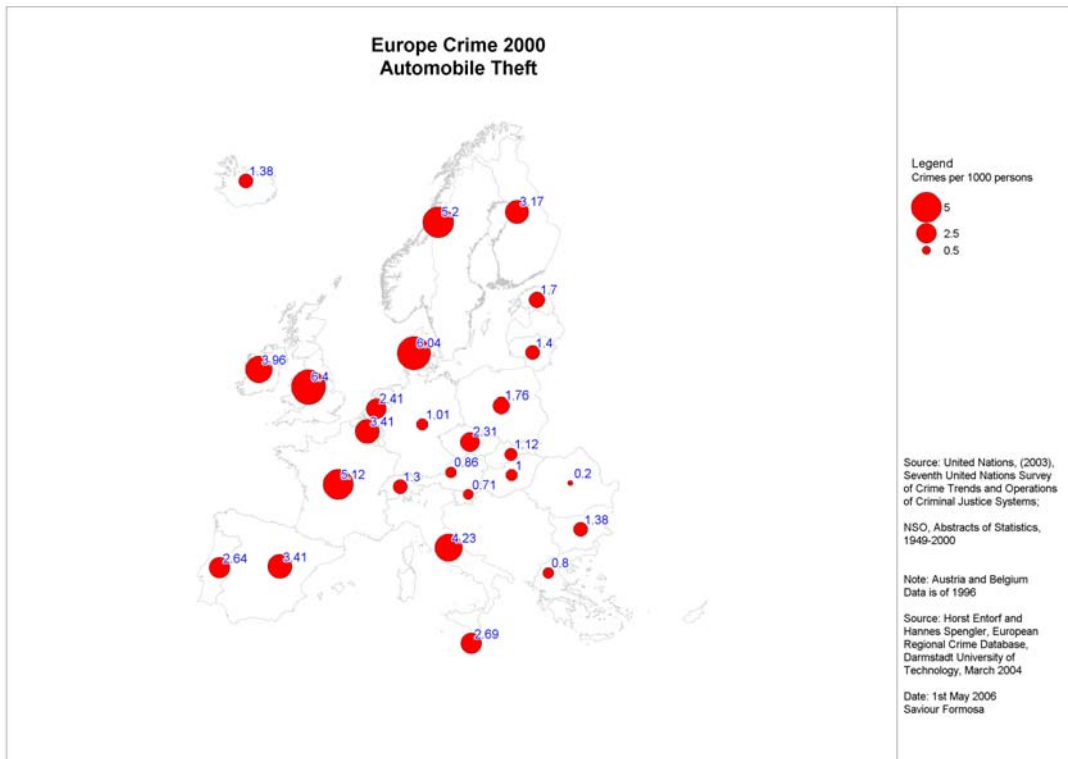
### Grand Total of all Recorded Crimes



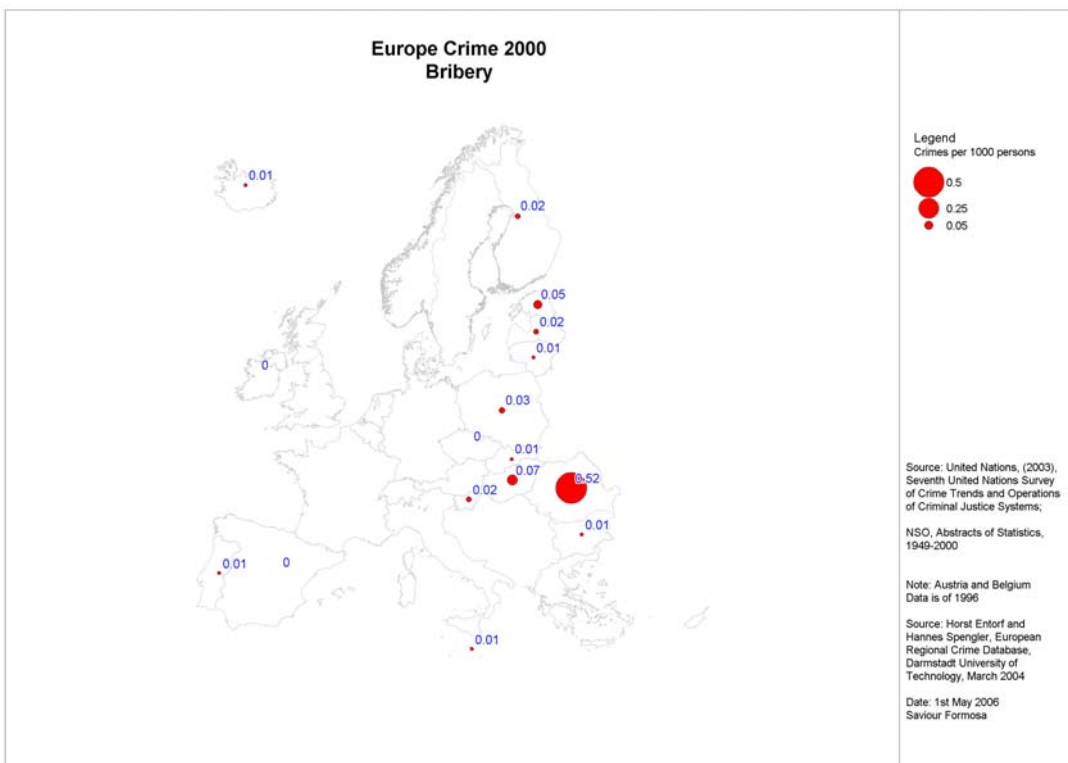
### Assaults



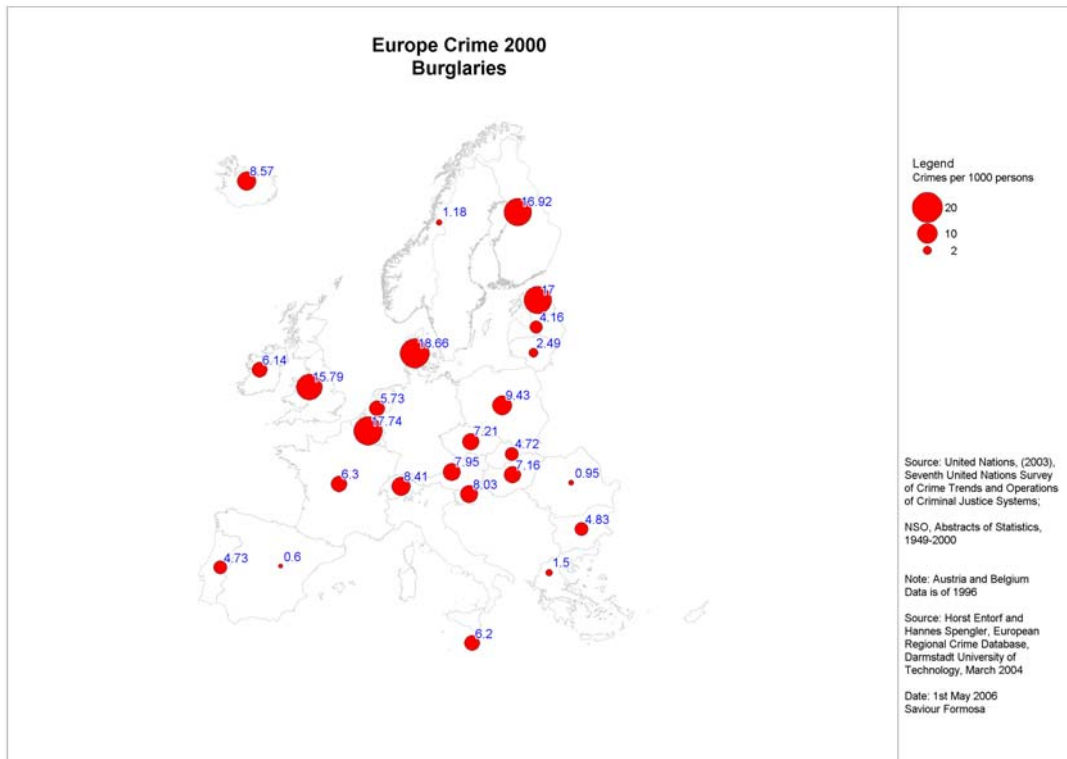
## Automobile theft



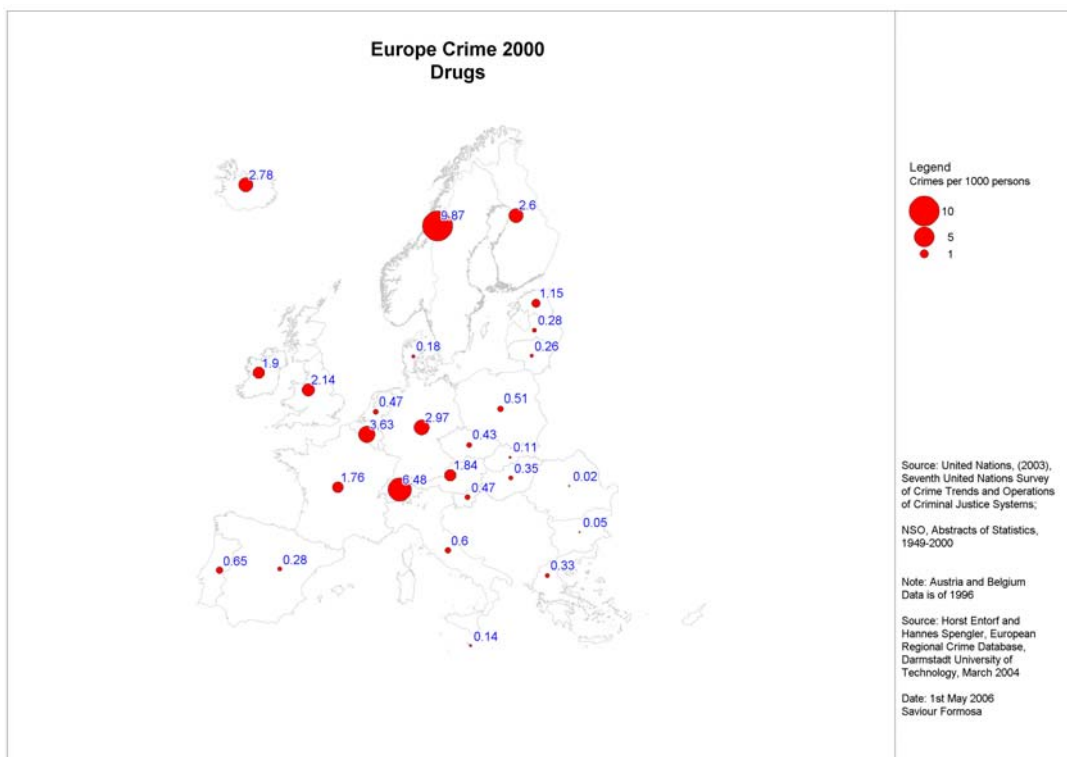
## Bribery crimes



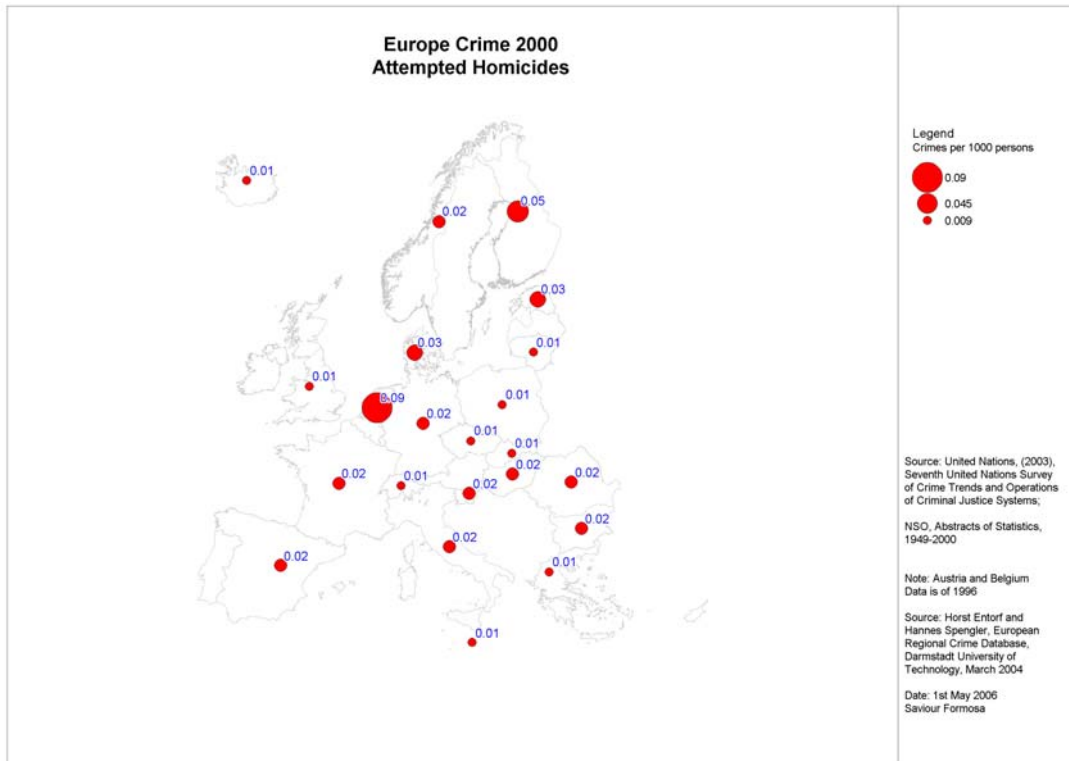
## Burglaries



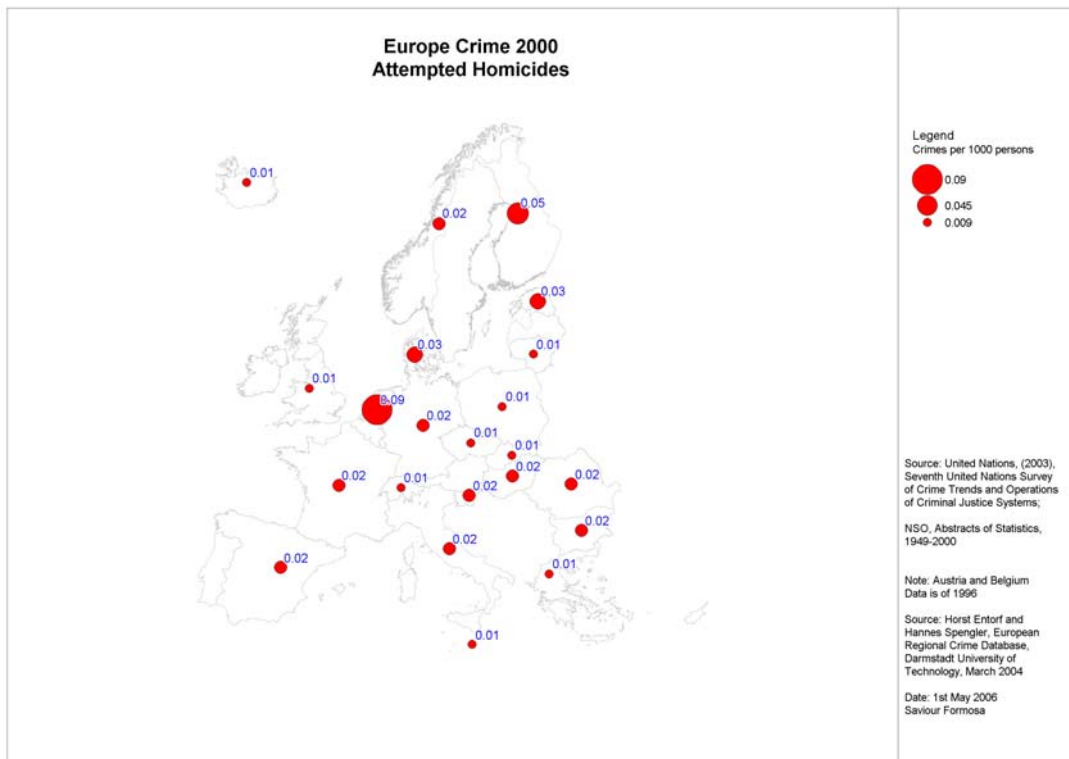
## Drug offenses



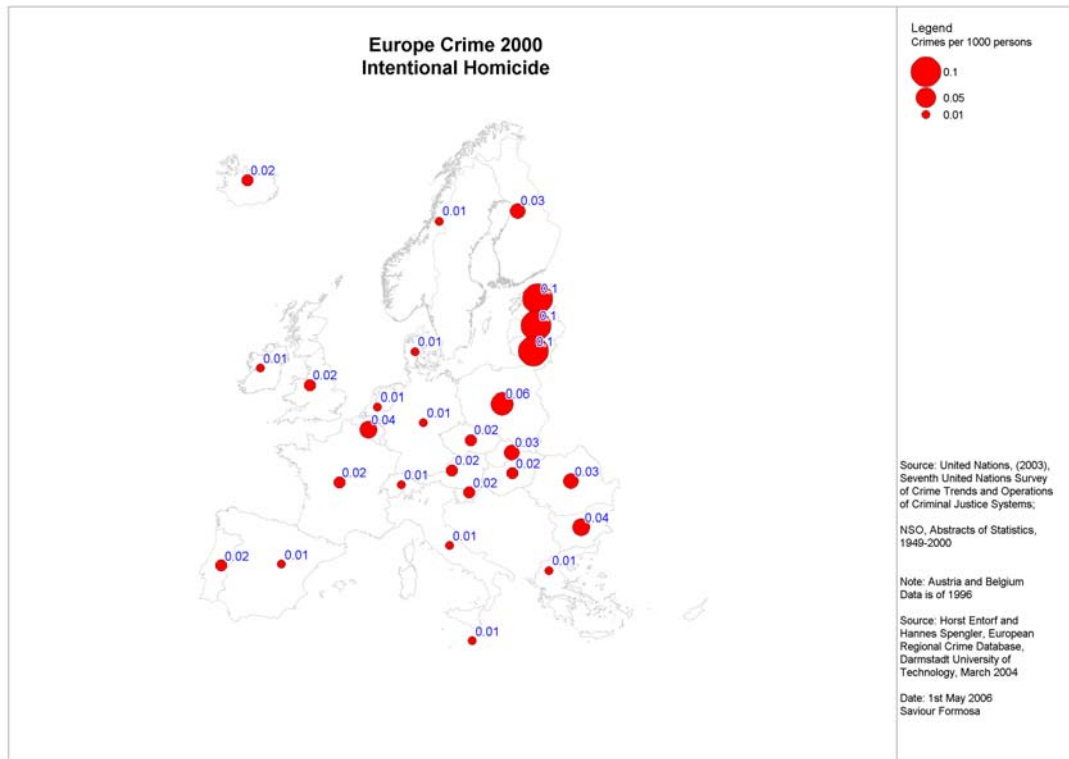
## Frauds



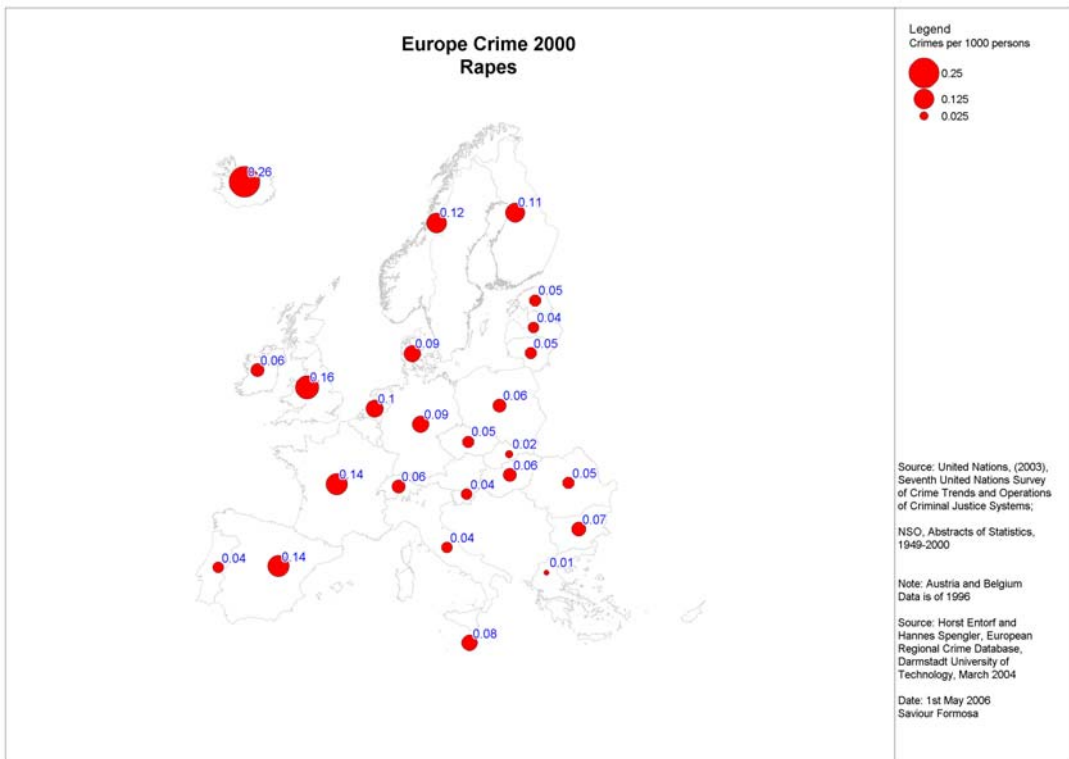
## Intentional homicide, attempted



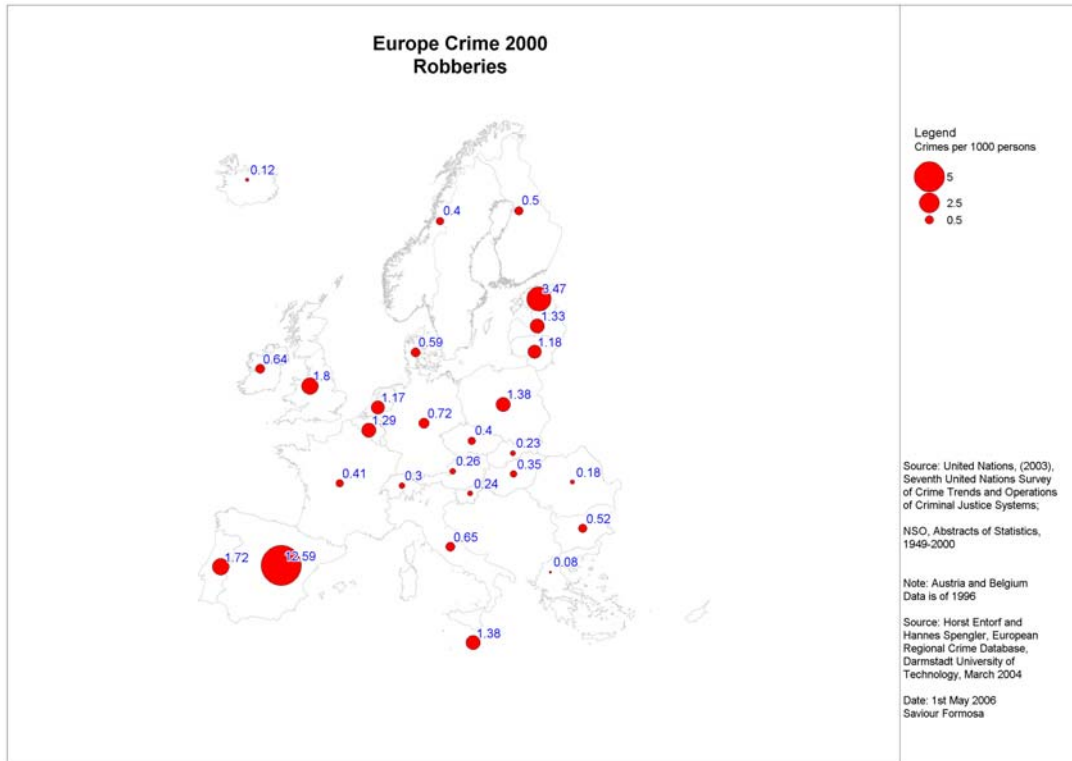
## Intentional homicide, completed



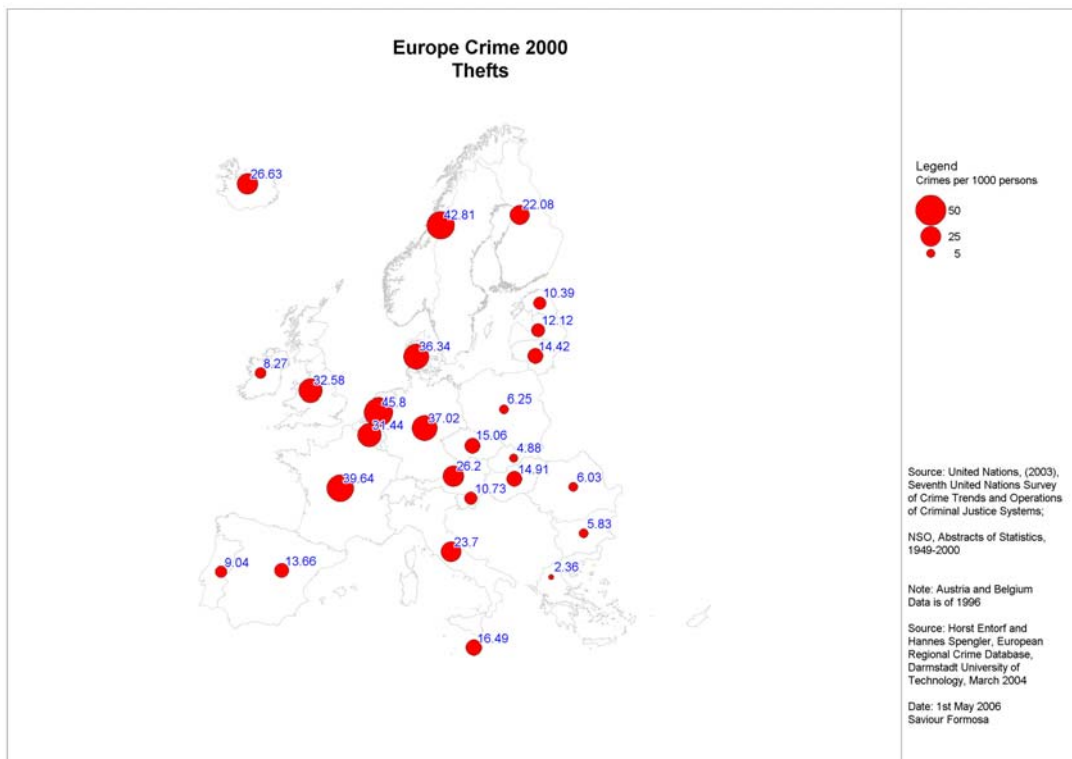
## Rapes



## Robberies

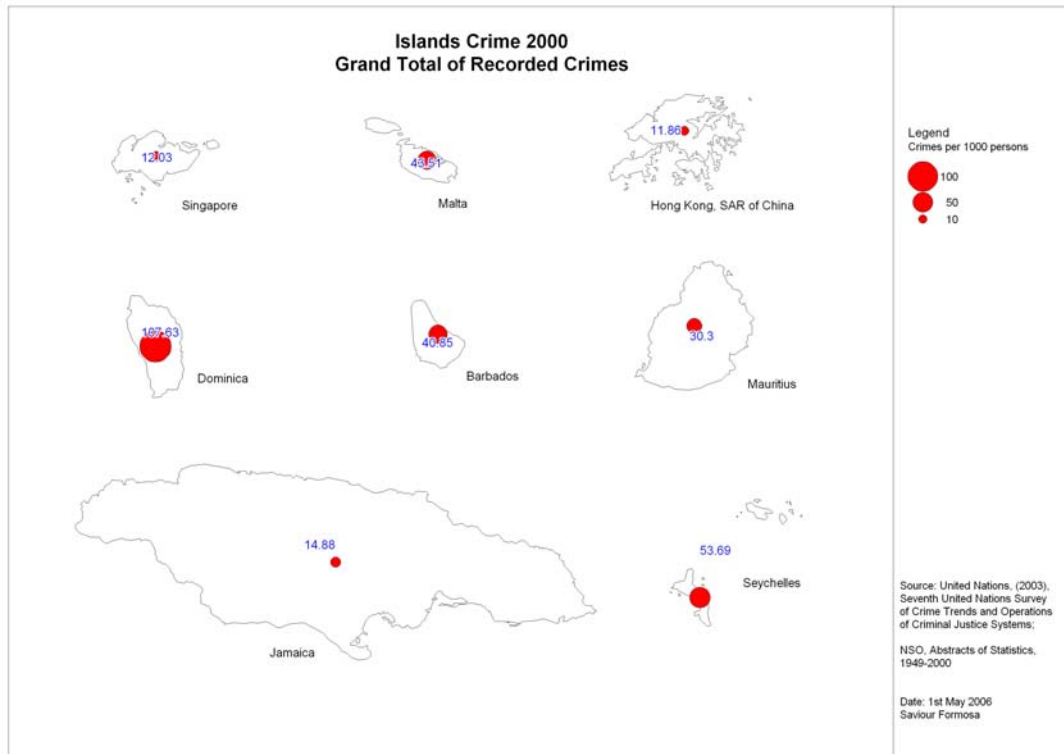


## Thefts

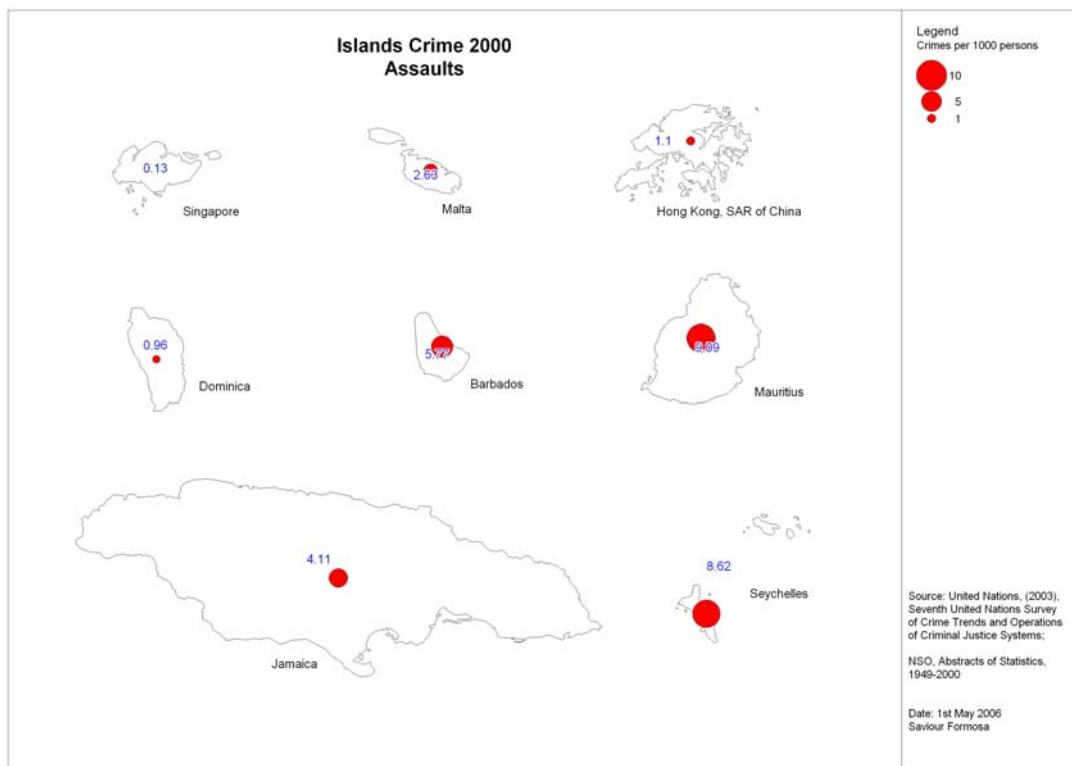


## ii) Crime maps: Malta in the Islands Perspective

### Grand Total of all Recorded Crimes

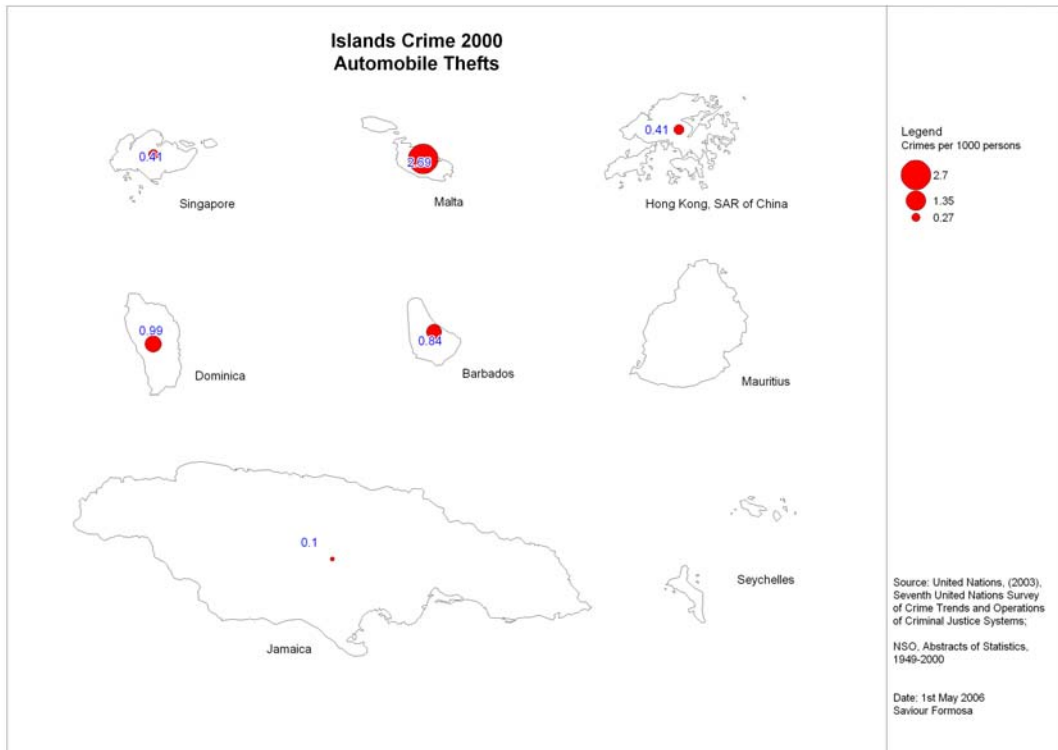


### Assaults

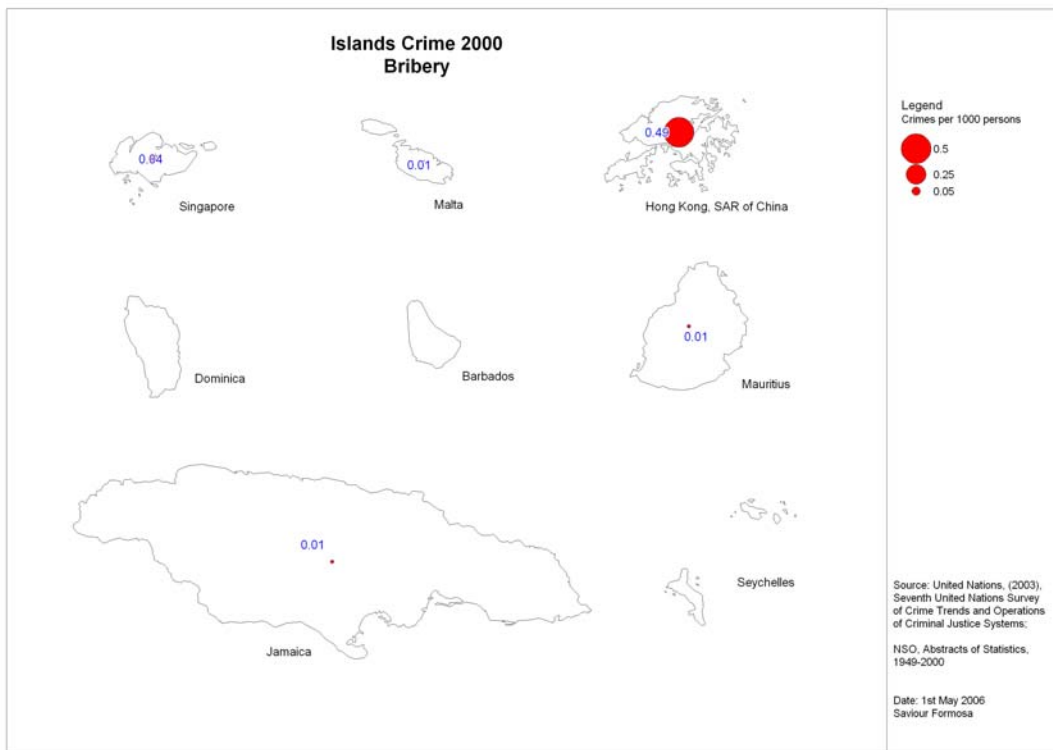




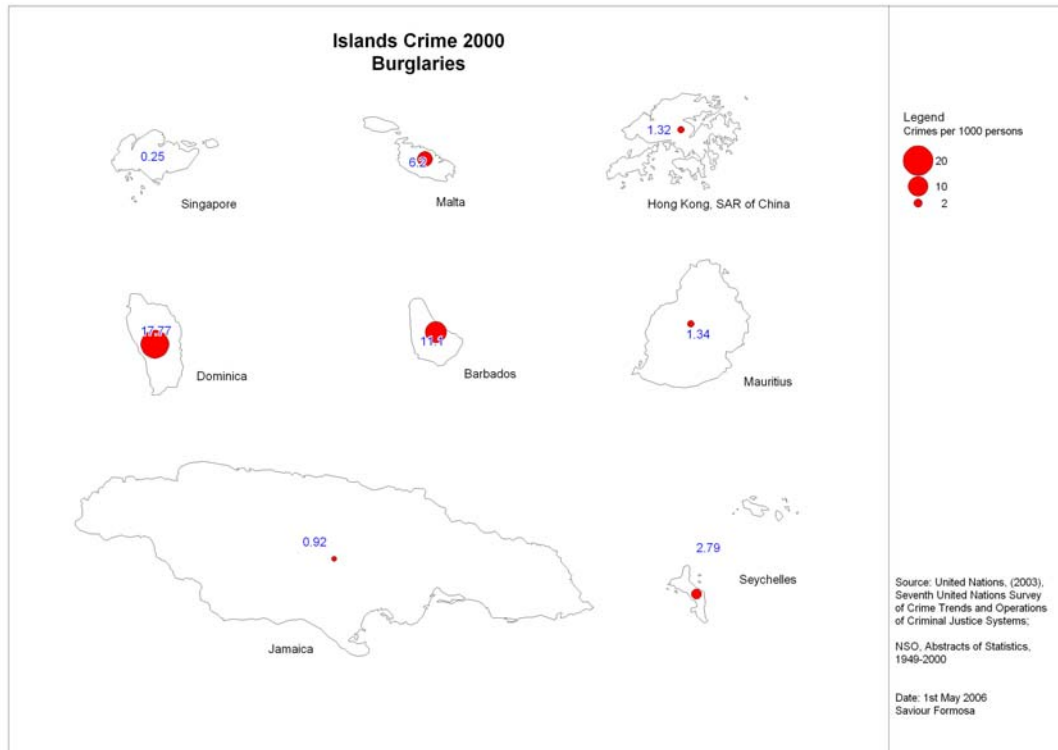
## Automobile theft



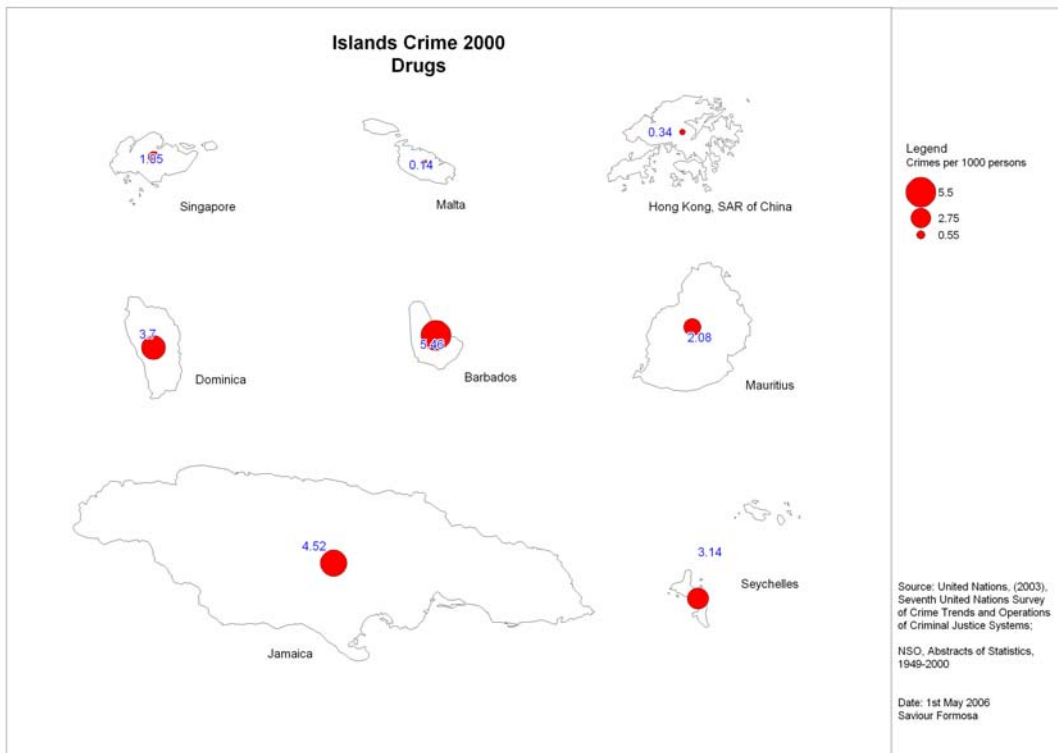
## Bribery crimes



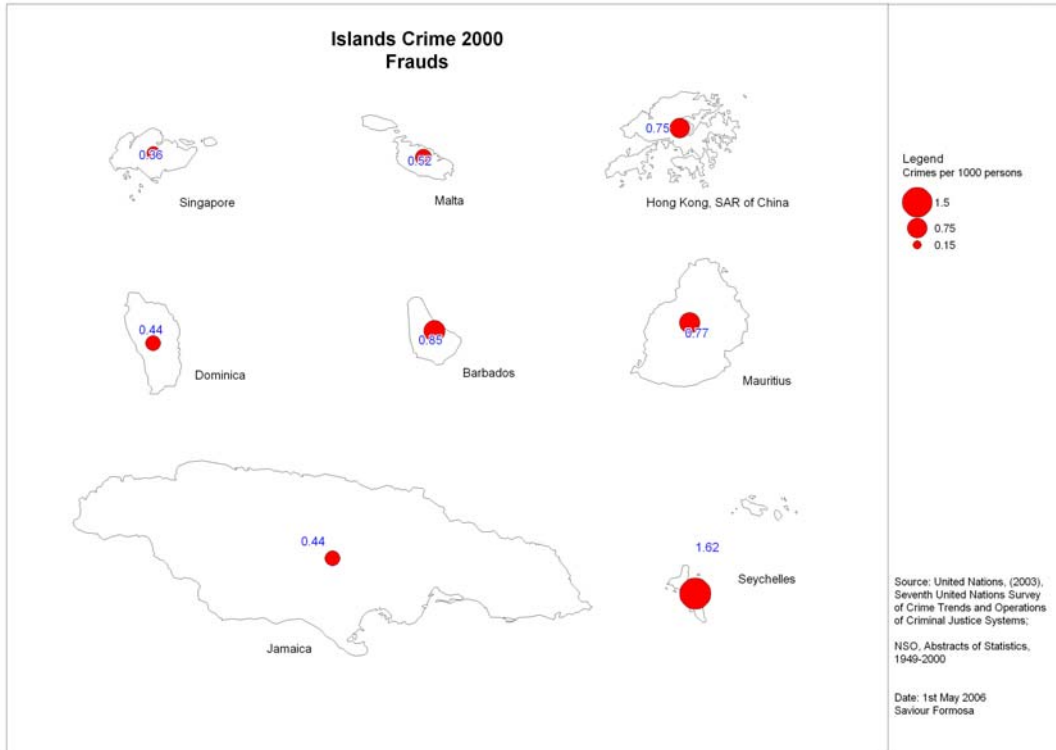
## Burglaries



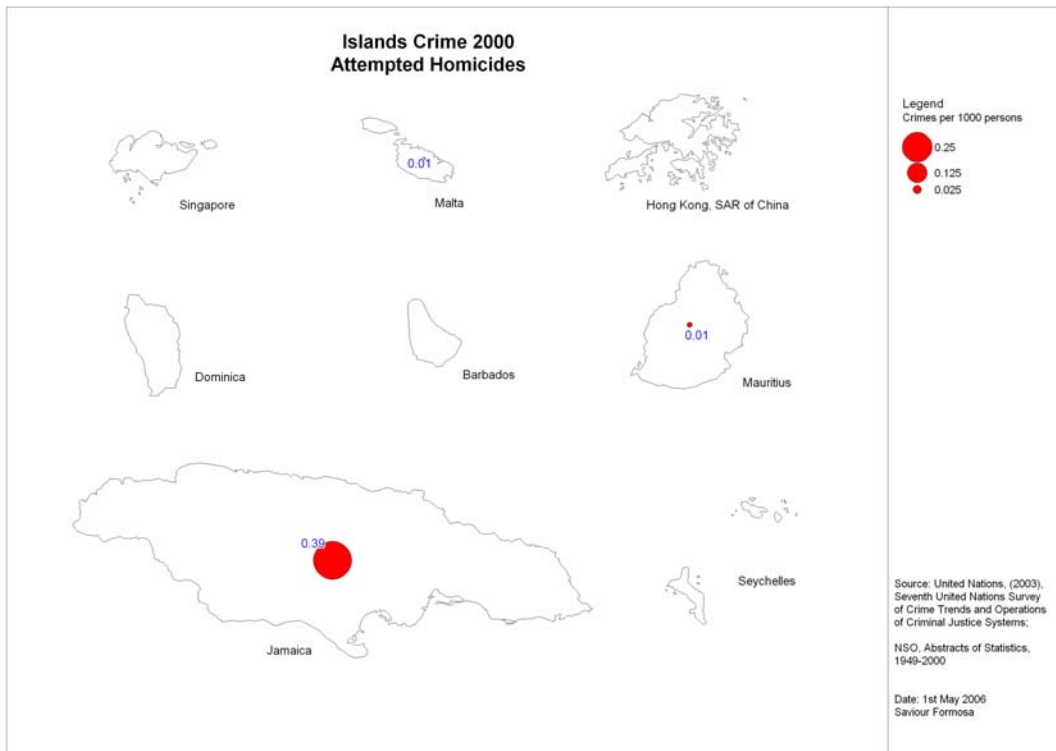
## Drug offenses



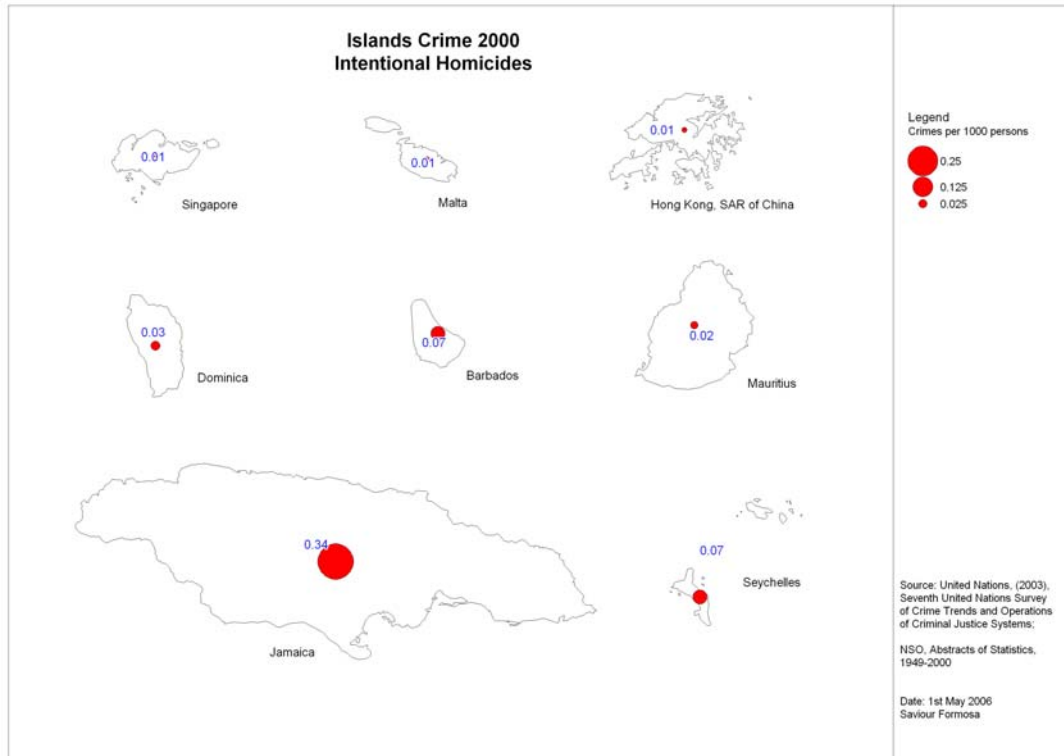
## Frauds



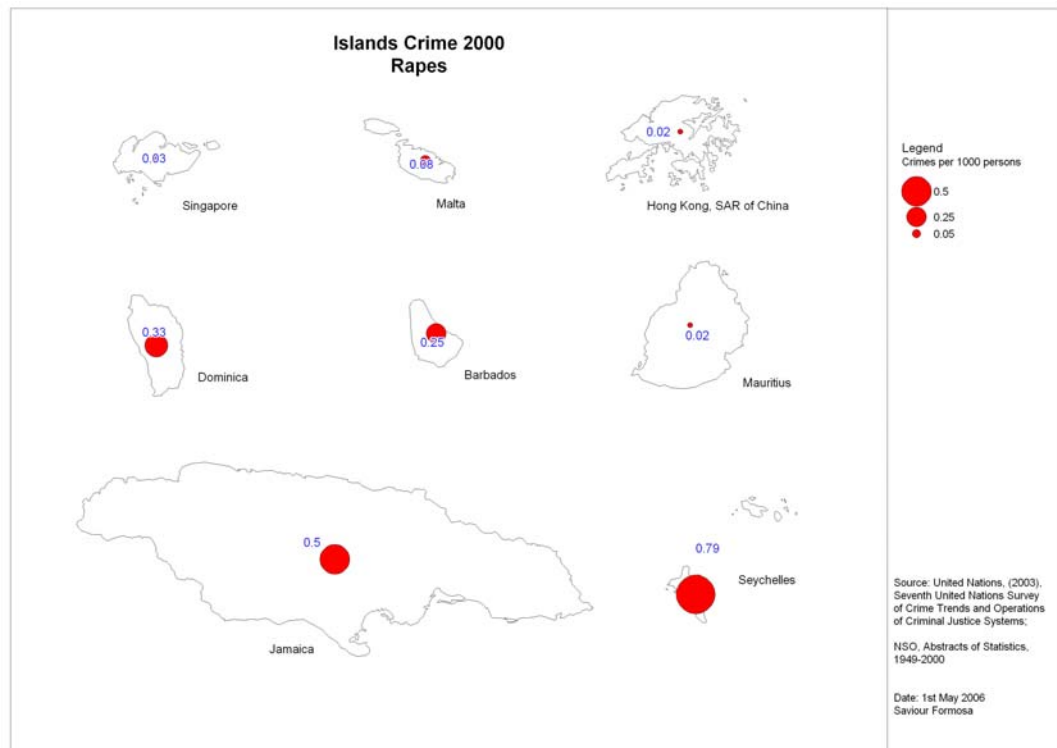
## Intentional homicide, attempted



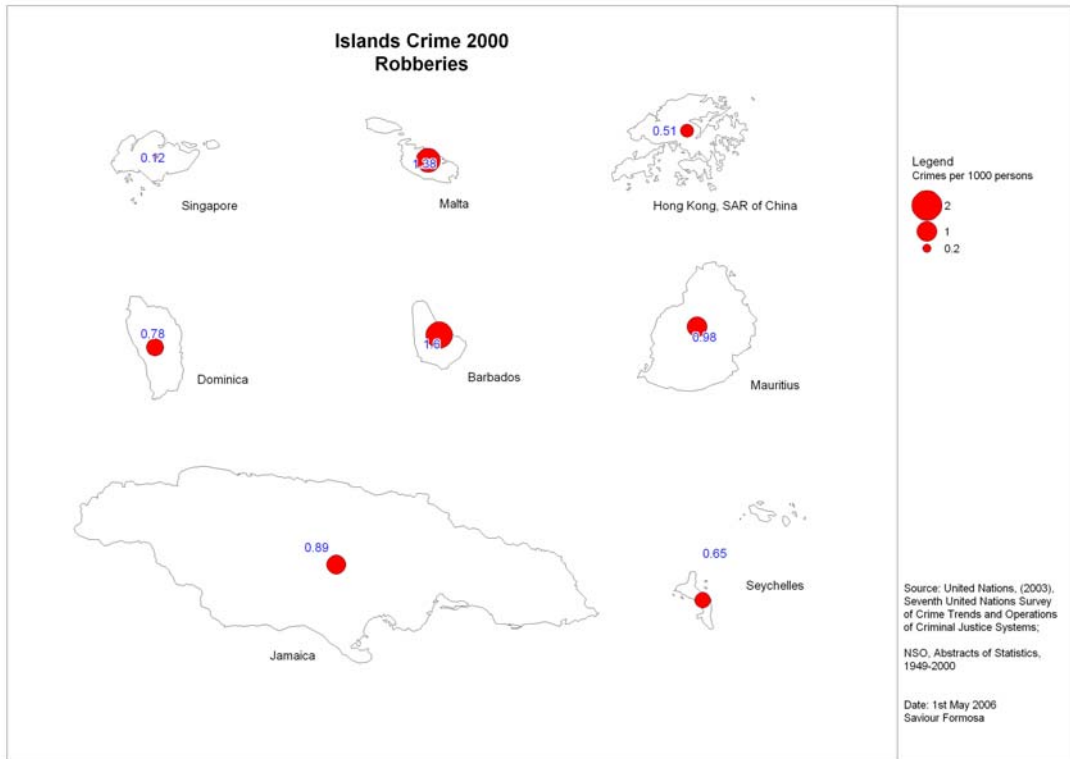
## Intentional homicide, completed



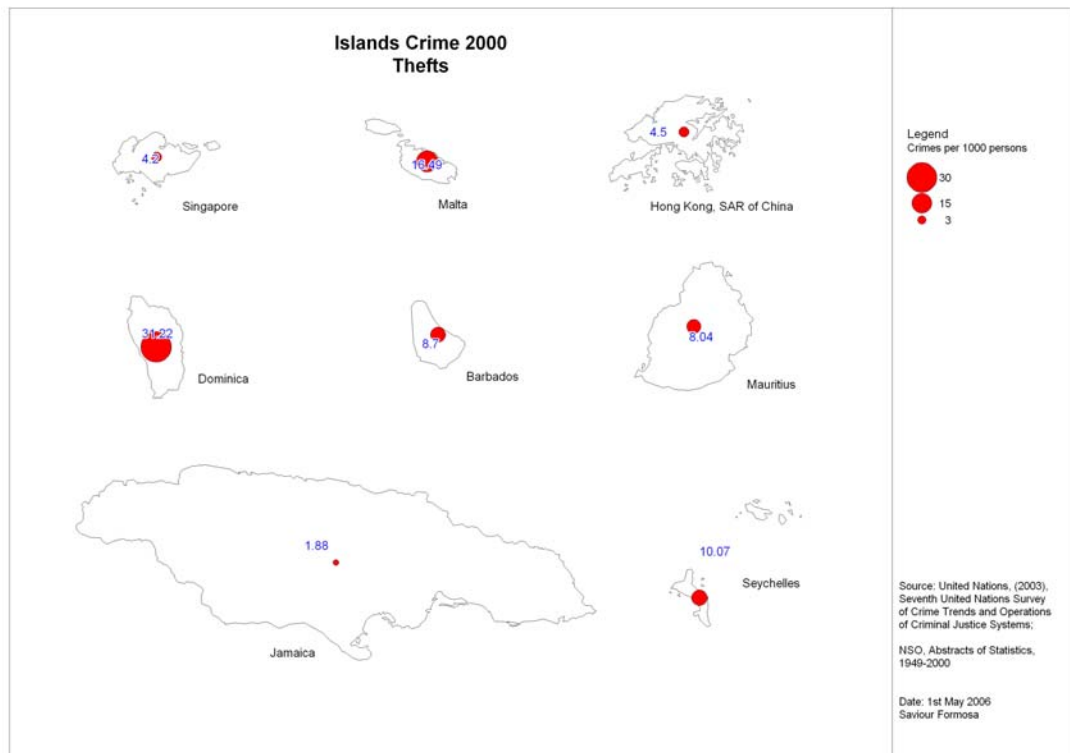
## Rapes



## Robberies



## Thefts



## Appendix 7: Offences in Malta - a 50 year perspective

### Tables used in Chapter 7, depicted in this Appendix in both Counts and Percentages

- Crimes known to the police

Type of Offence: 1950-1997 (July)

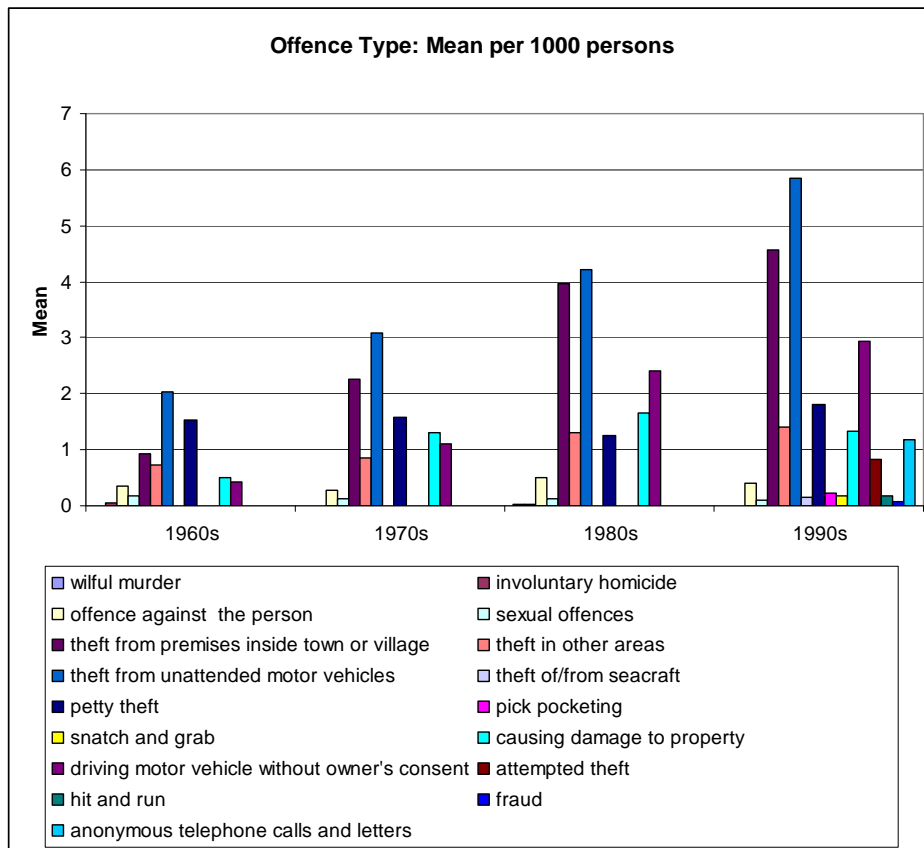
Type of Offence: 1950-1997 (July)																		
Type of Offence																		
Counts	ALL CRIMES	wilful murder	involuntary homicide	offence against the person	sexual offences	theft from premises inside town or village	theft in other areas	theft from unattended motor vehicles	theft of/from seacraft	petty theft	pick pocketing	snatch and grab	causing damage to property	driving motor vehicle without owner's consent	attempted theft	hit and run	fraud	anonymous telephone calls and letters
1950s	0	0	0	0	0	0	0	0	0	0	0	0	0	0	0	0	0	0
1960s	14881	4	62	528	260	1422	1125	3130	0	2357	0	0	775	650	0	0	0	0
1970s	36372	29	34	856	414	7137	2655	9749	0	5015	0	0	4140	3535	0	0	0	0
1980s	53465	54	82	1720	437	13685	4501	14583	0	4304	0	0	5773	8326	0	0	0	0
1990s	57193	35	5	1172	281	13622	4169	17445	187	5403	249	193	3941	8751	632	138	67	903
<b>Total</b>	161911	122	183	4276	1392	35866	12450	44907	187	17079	249	193	14629	21262	632	138	67	903

Type of Offence																		
Period - Percentages	ALL CRIMES	wilful murder	involuntary homicide	offence against the person	sexual offences	theft from premises inside town or village	theft in other areas	theft from unattended motor vehicles	theft of/from seacraft	petty theft	pick pocketing	snatch and grab	causing damage to property	driving motor vehicle without owner's consent	attempted theft	hit and run	fraud	anonymous telephone calls and letters
1950s																		
1960s		0.0	0.6	5.1	2.5	13.8	10.9	30.4	0.0	22.9	0.0	0.0	7.5	6.3	0.0	0.0	0.0	0.0
1970s		0.1	0.1	2.6	1.2	21.3	7.9	29.0	0.0	14.9	0.0	0.0	12.3	10.5	0.0	0.0	0.0	0.0
1980s		0.1	0.2	3.2	0.8	25.6	8.4	27.3	0.0	8.1	0.0	0.0	10.8	15.6	0.0	0.0	0.0	0.0
1990s		0.1	0.0	2.1	0.5	24.3	7.4	31.1	0.3	9.6	0.4	0.3	7.0	15.6	1.1	0.2	0.1	1.6
<b>Total</b>		0.1	0.1	2.8	0.9	23.4	8.1	29.3	0.1	11.1	0.2	0.1	9.5	13.9	0.4	0.1	0.0	0.6

Note: data for 1965-1997 July available

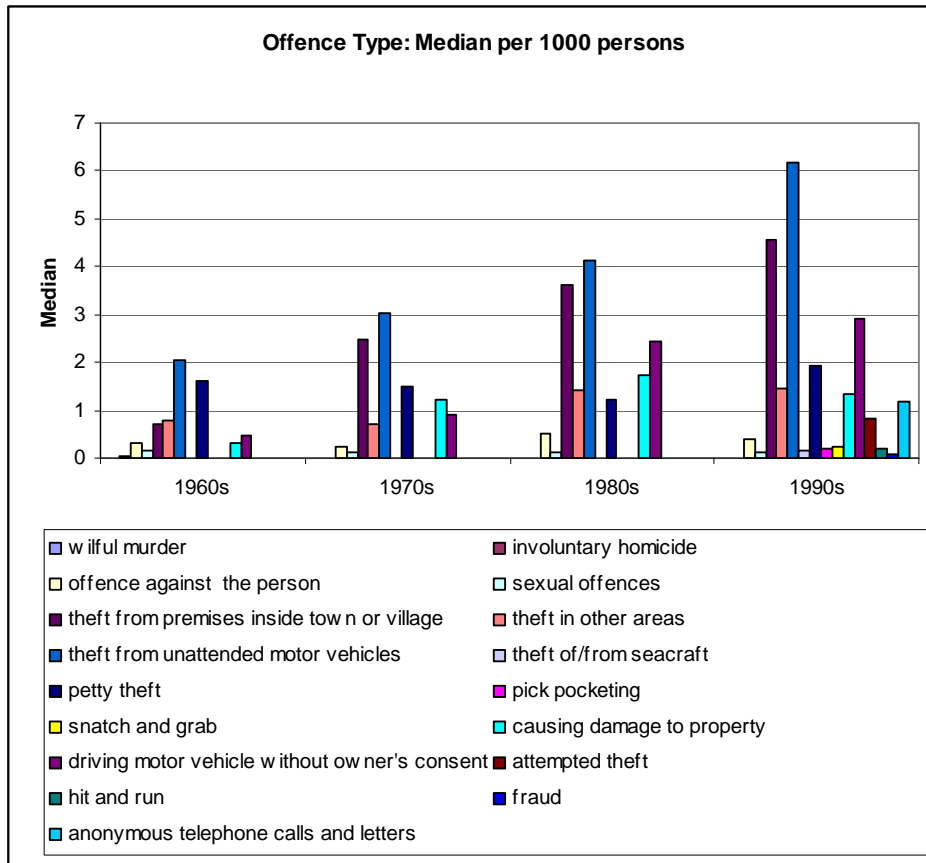
Type of Offence (Mean per 1000)																		
Counts	ALL CRIMES	wilful murder	involuntary homicide	offence against the person	sexual offences	theft from premises inside town or village	theft in other areas	theft from unattended motor vehicles	theft of/from seacraft	petty theft	pick pocketing	snatch and grab	causing damage to property	driving motor vehicle without owner's consent	attempted theft	hit and run	fraud	anonymous telephone calls and letters
1950s																		
1960s	9.7	0.00	0.04	0.3	0.2	0.9	0.7	2.0		1.5			0.5	0.4				
1970s	11.5	0.01	0.01	0.3	0.1	2.2	0.8	3.1		1.6			1.3	1.1				
1980s	15.5	0.02	0.03	0.5	0.1	4.0	1.3	4.2		1.2			1.7	2.4				
1990s	19.2	0.01	0.00	0.4	0.1	4.6	1.4	5.9	0.2	1.8	0.2	0.2	1.3	2.9	0.8	0.2	0.1	1.2

Note: data for 1965-1997 July available



Type of Offence (Median per 1000)																		
Counts	ALL CRIMES	wilful murder	involuntary homicide	offence against the person	sexual offences	theft from premises inside town or village	theft in other areas	theft from unattended motor vehicles	theft of/from seacraft	petty theft	pick pocketing	snatch and grab	causing damage to property	driving motor vehicle without owner's consent	attempted theft	hit and run	fraud	anonymous telephone calls and letters
1950s																		
1960s	8.3	0.00	0.04	0.3	0.2	0.7	0.8	2.0		1.6			0.3	0.5				
1970s	10.9	0.01	0.01	0.3	0.1	2.5	0.7	3.0		1.5			1.2	0.9				
1980s	15.5	0.01	0.02	0.5	0.1	3.6	1.4	4.1		1.2			1.7	2.5				
1990s	20.1	0.01	0.01	0.4	0.1	4.6	1.5	6.2	0.2	1.9	0.2	0.2	1.3	2.9	0.8	0.2	0.1	1.2

Note: data for 1965-1997 July available





Type of Offence: 1997 (Aug) - 2005

Type of offence	Aug - Dec 1997	1998	1999	2000	2001	2002	2003	2004	2005
All crimes	6170	15771	16046	17030	15912	17043	17773	18388	18579
Abortion/supply of poisonous substance	1	2			1				
Abuse of public authority	2	3		5	2	1	1	3	
Abuses relating to prisons			1		4			2	
Against morals/honour -family	29	67	52	40	32	41	26	36	30
Arson	33	105	143	105	95	92	120	120	124
Attempted offences	210	1326	908	1108	1029	1309	1349	1259	1377
Bankruptcy offences				1					
Bigamy								1	
Bodily harm	280	556	660	748	746	824	998	1065	1092
Computer misuse						2	4	11	11
Concealment of bodies		1	1						
Crimes against public peace	18	17	4	7	10	5	3	1	
Crimes against public safety	13	11	8	12	7	5	3	1	2
Crimes against religious sentiment		2	1	1	2		3		1
Crimes against the administration of justice etc		1	14	10	6	10	4	6	9
Damage	1919	4634	4237	3706	3419	3460	3576	3657	3687
Drugs	32	43	65	56	54	53	47	78	113
Forgery	6	17	34	43	34	34	21	91	56
Fraud	37	120	192	202	122	141	142	160	179
Homicide	1	5	9	4	5	5		7	4
Immigration	30	84	115	138	172	186	137	123	189
Infanticide/abandonment of child	1		5	2	5	4	3	5	1
Malversation by public officer	1	2	1	4	1				
Perjury & false swearing		4	6	3	1	4	8	2	1
Prostitution	1	10	28	23	17	22	8	16	46
Safety of the government		1							
Sexual offence	32	54	68	56	42	53	74	61	71
Theft	3339	8115	9187	10472	9824	10518	11024	11465	11398
Threats and private violence	160	465	240	184	196	158	111	104	84
Trafficking of persons									1
Violation of places of confinement		4	4	4	3	5	6	3	9
Violence against public officer	25	122	63	96	83	111	105	111	94

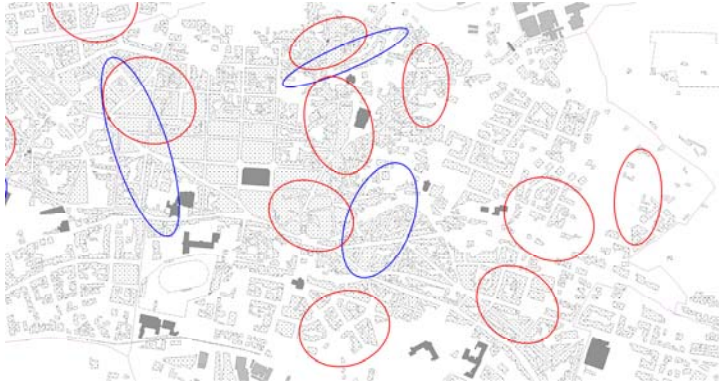
Crimes post-1997 per 1000 persons

Type of offence	Aug - Dec 1997	1998	1999	2000	2001	2002	2003	2004	2005
All crimes	16.06	40.82	41.27	43.51	40.32	42.90	44.44	45.66	45.82
Abortion/supply of poisonous substance	0.00	0.01			0.00				
Abuse of public authority	0.01	0.01		0.01	0.01	0.00	0.00	0.01	
Abuses relating to prisons			0.00		0.01			0.00	
Against morals/honour -family	0.08	0.17	0.13	0.10	0.08	0.10	0.07	0.09	0.07
Arson	0.09	0.27	0.37	0.27	0.24	0.23	0.30	0.30	0.31
Attempted offences	0.55	3.43	2.34	2.83	2.61	3.29	3.37	3.13	3.40
Bankruptcy offences				0.00					
Bigamy								0.00	
Bodily harm	0.73	1.44	1.70	1.91	1.89	2.07	2.50	2.64	2.69
Computer misuse						0.01	0.01	0.03	0.03
Concealment of bodies		0.00	0.00						
Crimes against public peace	0.05	0.04	0.01	0.02	0.03	0.01	0.01	0.00	
Crimes against public safety	0.03	0.03	0.02	0.03	0.02	0.01	0.01	0.00	0.00
Crimes against religious sentiment		0.01	0.00	0.00	0.01		0.01		0.00
Crimes against the administration of justice etc		0.00	0.04	0.03	0.02	0.03	0.01	0.01	0.02
Damage	4.99	11.99	10.90	9.47	8.66	8.71	8.94	9.08	9.09
Drugs	0.08	0.11	0.17	0.14	0.14	0.13	0.12	0.19	0.28
Forgery	0.02	0.04	0.09	0.11	0.09	0.09	0.05	0.23	0.14
Fraud	0.10	0.31	0.49	0.52	0.31	0.35	0.36	0.40	0.44
Homicide	0.00	0.01	0.02	0.01	0.01	0.01		0.02	0.01
Immigration	0.08	0.22	0.30	0.35	0.44	0.47	0.34	0.31	0.47
Infanticide/abandonment of child	0.00		0.01	0.01	0.01	0.01	0.01	0.01	0.00
Malversation by public officer	0.00	0.01	0.00	0.01	0.00				
Perjury & false swearing		0.01	0.02	0.01	0.00	0.01	0.02	0.00	0.00
Prostitution	0.00	0.03	0.07	0.06	0.04	0.06	0.02	0.04	0.11
Safety of the government		0.00							
Sexual offence	0.08	0.14	0.17	0.14	0.11	0.13	0.19	0.15	0.18
Theft	8.69	21.00	23.63	26.76	24.90	26.47	27.57	28.47	28.11
Threats and private violence	0.42	1.20	0.62	0.47	0.50	0.40	0.28	0.26	0.21
Trafficking of persons									0.00
Violation of places of confinement		0.01	0.01	0.01	0.01	0.01	0.02	0.01	0.02
Violence against public officer	0.07	0.32	0.16	0.25	0.21	0.28	0.26	0.28	0.23

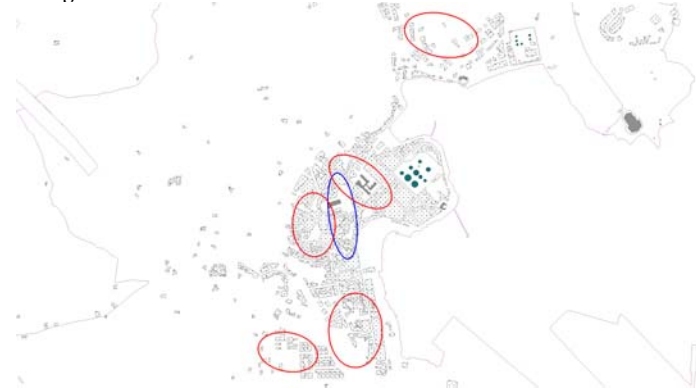
## Appendix 8: Crime Maps – Overlaying Offender and Poverty Hotspots by Locality

Legend: **Red** Hotspots represent Poverty, **BLUE** hotspots represent Offenders

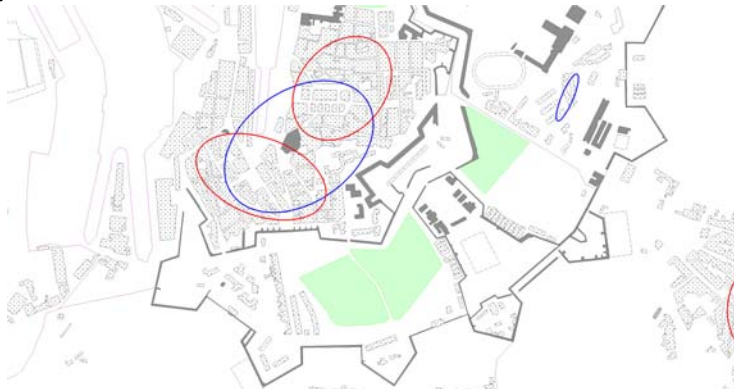
**Birkirkara**



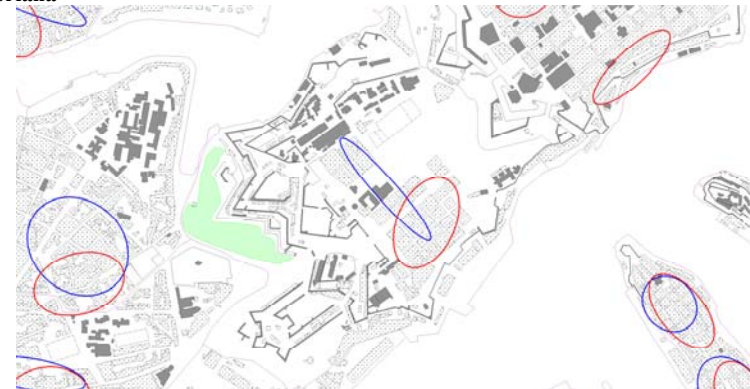
**Birzebbugia**



**Bormla**



**Floriana**



**Gzira**



**Hamrun**



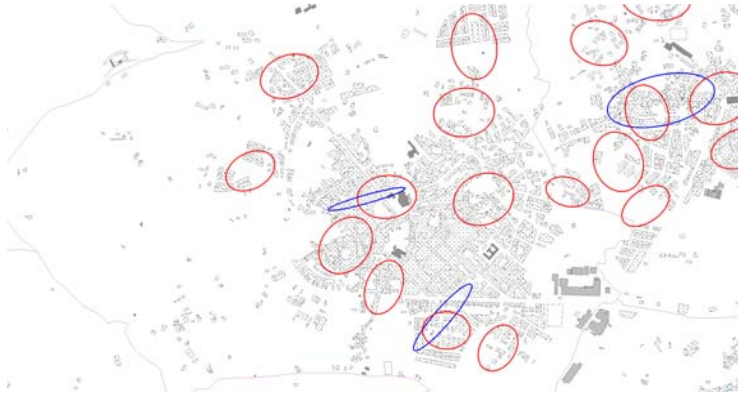
**Isla and Birgu**



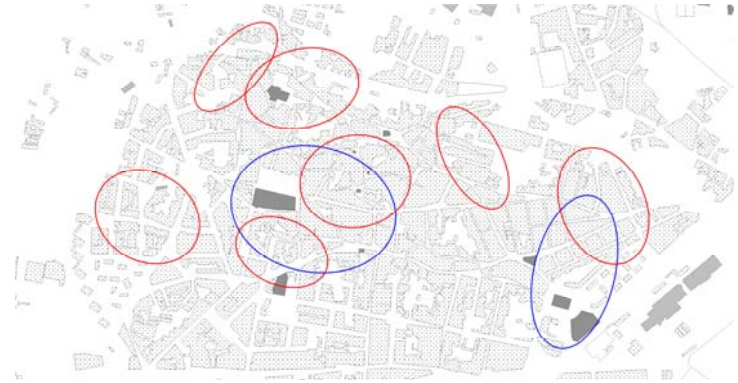
**Marsa**



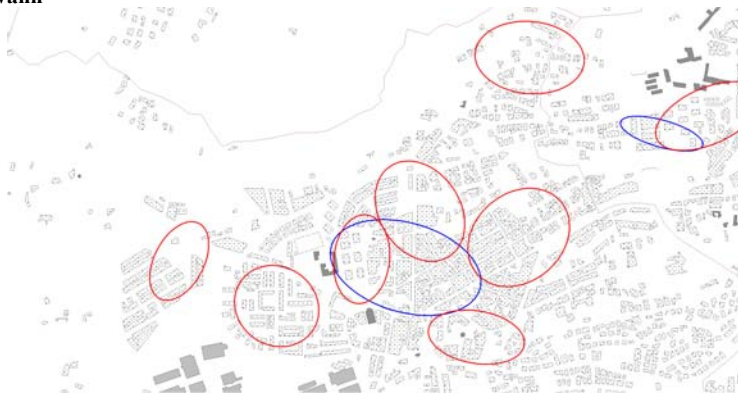
**Mosta**



**Qormi**



**San Gwann**



**San Pawl il-Bahar**





**Santa Lucija**



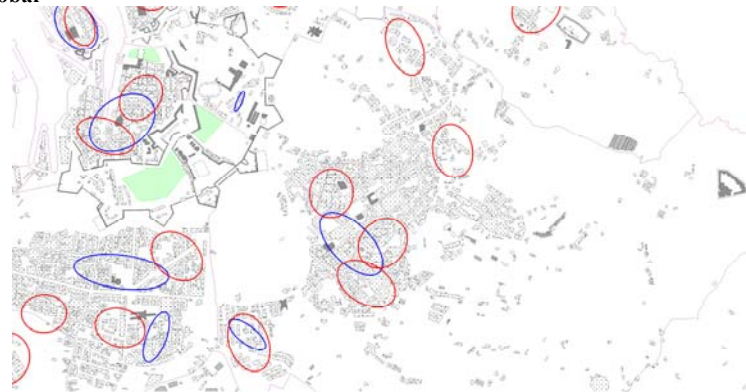
**Sliema**



**Ta' Xbiex**



**Zabbar**



## Appendix 9: Craglia et al (2000) Rate and Risk Assessment Methodologies

---

### Calculating the risk assessment

**Note:** The steps to calculate risk assessment, detailed in the following examples, are based on the calculation of the national unemployment rate per population and the resultant Standard Poverty Rate (SPR) is calculated for each Enumeration Area (EAs), the smallest spatial aggregation entity in Malta. This result gave the expected number of unemployed persons in each area, which was then compared with the observed number of unemployed. The result of the latter analysis would give an indication if an area is at high risk where the figure (for each EAs) is greater than 100. A figure of 100 equates to the national poverty risk, whilst a greater number indicates higher risks and a lower figure indicates lower risks respectively.

An example of the phases to correlate population density and crime density:

- A) Calculate EAs Population Density - Rates
  - B) Calculate Crime Density - Rates
  - C) Check Relationships Between Both – Correlations
- 

### Rate Examples:

#### Rate 1: Population Density

Step 1: Calculating the Standard Population Density Rate

$$\begin{aligned} \text{Standard Population Density (SPD)} &= \frac{\text{Total Population}}{\text{Total Area}} \\ \text{Standard Population Density (SPD)} &= \frac{367,879}{315.705} \\ \text{SPD} &= 1165.3 \end{aligned}$$

Step 2: Calculating the Expected Population in Enumeration Areas

$$\begin{array}{l} \text{Expected Population in} \\ \text{Enumeration Areas (ED) for each} \\ \text{EAs} \end{array} = \text{SPD} \times \text{Area in each EAs}$$

Step 3: Calculating the Density Rate for each Enumeration Area

$$\text{Density Rate for each EAs} = \frac{\text{Observed Population (OD)}}{\text{Expected Population (ED)}} \times 100$$

---

### **Rate 2: Offender Density**

**Step 1:** Calculating the Standard Offender Density Rate

$$\text{Standard Offender Density (SOD)} = \frac{\text{Total Offenders}}{\text{Total Area}}$$

$$\text{Standard Offender Density (SOD)} = \frac{1894}{315.705}$$

$$\text{SOD} = 6.0$$

Step 2: Calculating the Expected Population in Enumeration Areas

$$\begin{array}{l} \text{Expected Offender in Enumeration} \\ \text{Areas (EO) for each EAs} \end{array} = \text{SOD} \times \text{Area in each EAs}$$

Step 3: Calculating the Density Rate for each Enumeration Area

$$\text{Density Rate for each EAs} = \frac{\text{Observed Population (OO)}}{\text{Expected Population (EO)}} \times 100$$

---



### Rate 3: Poverty Rate

Step 1: Calculating the Standard Poverty Rate

$$\text{Standard Poverty Rate (SPR)} = \frac{\text{Total Unemployed}}{\text{Total Persons}}$$

$$\text{Standard Poverty Rate (SPR)} = \frac{7,326}{367,879}$$

$$\text{SPR} = 0.02$$

Step 2: Calculating the Expected Poverty in Enumeration Areas

$$\text{Expected Poverty in Enumeration Areas (EP) for each EAs} = \text{SPR} \times \text{No. of Persons in each EAs}$$

Step 3: Calculating the Risk of Poverty for each Enumeration Area

$$\text{Risk of Poverty for each EAs} = \frac{\text{Observed Unemployment (OP)}}{\text{Expected Poverty (EP)}} \times 100$$

---

### Rate 4: Dwelling Density

Step 1: Calculating the Standard Dwelling Density Rate

$$\text{Standard Dwelling Density (SDD)} = \frac{\text{Total Dwellings}}{\text{Total Area}}$$

$$\text{Standard Dwelling Density (SDD)} = \frac{185,802}{315.705}$$

$$\text{SDD} = 588.53$$

Step 2: Calculating the Expected Population in Enumeration Areas

$$\text{Expected Dwelling in Enumeration Areas (ED) for each EAs} = \text{SDD} \times \text{Area in each EAs}$$

Step 3: Calculating the Dwelling Density Rate for each Enumeration Area

$$\text{Dwelling Density Rate for each EAs} = \frac{\text{Observed Dwelling (OD)}}{\text{Expected Dwelling (ED)}} \times 100$$

---

### Rate 5: Vacant Dwellings

Step 1: Calculating the Standard Vacancy Rate – based on maltamal data

$$\text{Standard Vacancy Rate (SVR)} = \frac{\text{Total Vacant}}{\text{Total Dwellings}}$$

$$\text{Standard Vacancy Rate (SVR)} = \frac{11,556}{185,802}$$

$$\text{SVR} = 0.062$$

Step 2: Calculating the Expected Vacancy Rate in Enumeration Areas

$$\text{Expected Vacant Dwelling Units in Enumeration Areas (EV) for each EAs} = \text{SVR} \times \text{Units in each EAs}$$

Step 3: Calculating the Vacancy Rate for each Enumeration Area

$$\text{Vacancy Rate for each EAs} = \frac{\text{Observed Vacancy (OV)}}{\text{Expected Vacancy (EV)}} \times 100$$

---

### Rate 6: Offence (Incarcerated Offenders') Density

Step 1: Calculating the Standard Crime (Offence) Rate – based on geopol data

$$\text{Standard Crime Rate (SCR)} = \frac{\text{Total Offences}}{\text{Total Households}}$$

$$\text{Standard Crime Rate (SCR)} = \frac{99,575}{117,119}$$

$$\text{SCR} = 0.85$$

Step 2: Calculating the Expected Crime Rate in Enumeration Areas

$$\text{Expected Crime in Enumeration Areas (EC) for each EAs} = \text{SCR} \times \text{Number of Households in each EAs}$$

Step 3: Calculating the Crime Rate for each Enumeration Area

$$\text{Crime Rate for each EAs} = \frac{\text{Observed Crime (OC)}}{\text{Expected Crime (EC)}} \times 100$$

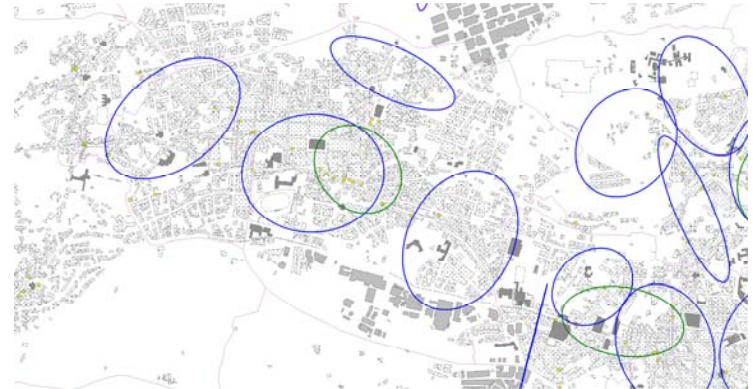
**Appendix 10: Crime Maps: Overlaying Offence and Recreation Hotspots by Locality**

Legend: **Green** Hotspots represent Recreation, **BLUE** hotspots represent Offences, Yellow stars represent recreation entities

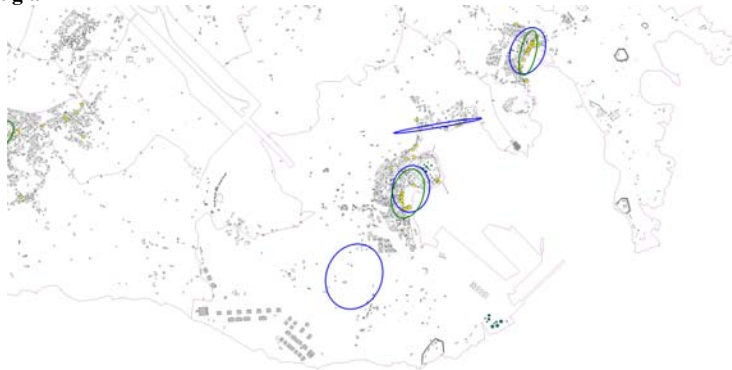
**Birgu, Bormla, Isla**



**Birkirkara**



**Birzebbugia**



**Floriana**



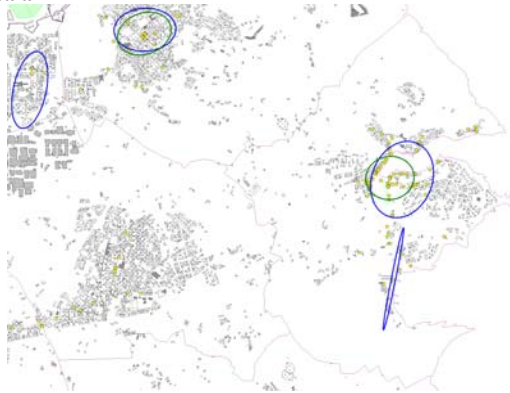
**Gzira and Ta' Xbiex**



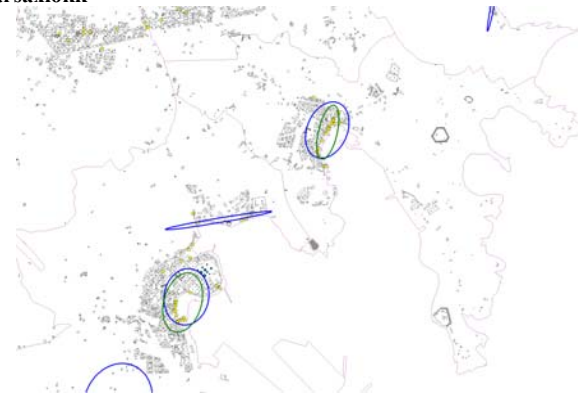
**Hamrun, Santa Venera and Marsa**



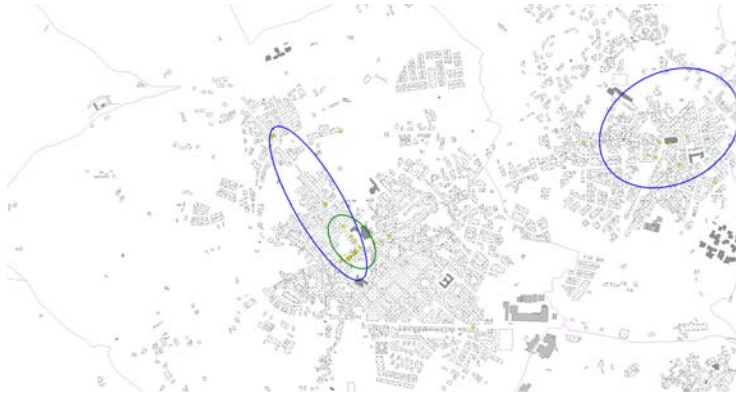
**Marsascala**



**Marsaxlokk**



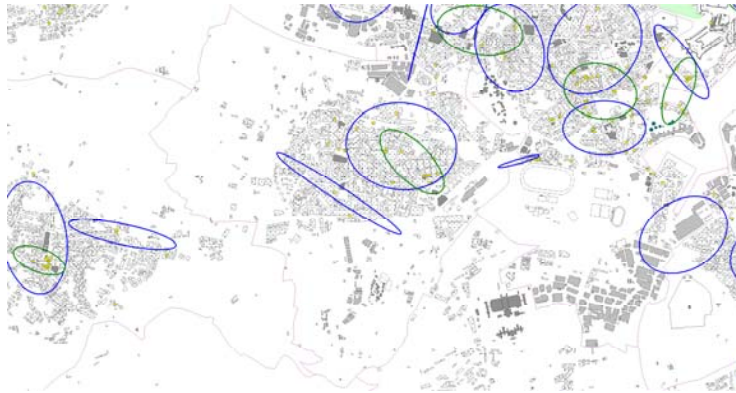
**Mosta**



**Msida**



**Qormi**

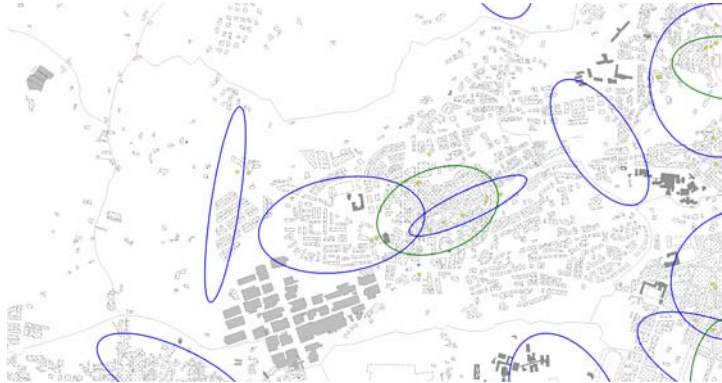


**Rabat (Malta)**





**San Gwann**



**Sliema**



**Zabbar**



**Zebbug (Malta)**

