



University of HUDDERSFIELD

University of Huddersfield Repository

Park, Kyooseon, Asim, Taimoor and Mishra, Rakesh

Numerical Investigations on the Effect of Blade Angles of a Vertical Axis Wind Turbine on its Performance Output

Original Citation

Park, Kyooseon, Asim, Taimoor and Mishra, Rakesh (2015) Numerical Investigations on the Effect of Blade Angles of a Vertical Axis Wind Turbine on its Performance Output. *International Journal of COMADEM*, 18 (3). pp. 3-10. ISSN 1363-7681

This version is available at <http://eprints.hud.ac.uk/id/eprint/25739/>

The University Repository is a digital collection of the research output of the University, available on Open Access. Copyright and Moral Rights for the items on this site are retained by the individual author and/or other copyright owners. Users may access full items free of charge; copies of full text items generally can be reproduced, displayed or performed and given to third parties in any format or medium for personal research or study, educational or not-for-profit purposes without prior permission or charge, provided:

- The authors, title and full bibliographic details is credited in any copy;
- A hyperlink and/or URL is included for the original metadata page; and
- The content is not changed in any way.

For more information, including our policy and submission procedure, please contact the Repository Team at: E.mailbox@hud.ac.uk.

<http://eprints.hud.ac.uk/>

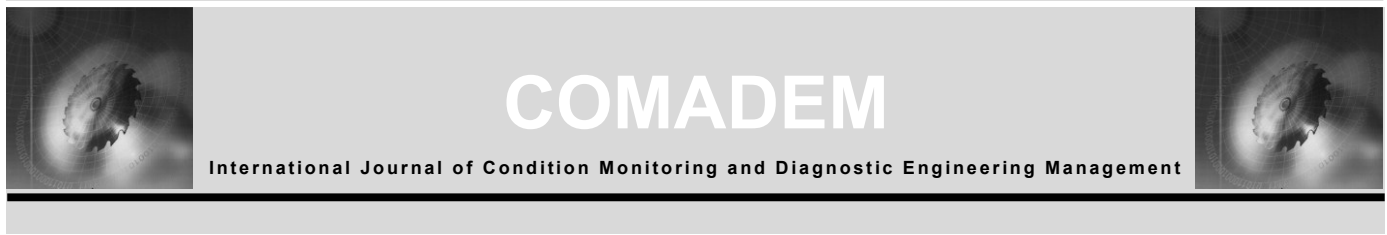

Numerical Investigations on the Effect of Blade Angles of a Vertical Axis Wind Turbine on its Performance Output

Kyoo-seon Park^a, Taimoor Asim^b*, and Rakesh Mishra^c

^{a,b,c} School of Computing & Engineering, University of Huddersfield, Huddersfield (HD1 3DH), UK

* Corresponding author. Tel.: +44-1484-2323; fax: +44-1484-516151; e-mail: t.asim@hud.ac.uk

ABSTRACT

There are many social, political and environmental issues associated with the use of fossil fuels. For this reason, there are numerous investigations currently being carried out to develop newer and renewable sources of energy to alleviate energy demand. Wind is one source of energy that can be harnessed using wind turbines. In this study, numerical investigations using Computational Fluid Dynamics (CFD) solver have been carried out to determine the optimum blade angles of a wind turbine used in urban environment. The effect of these blade angles have been considered to be within the normal operating range (α from 1.689° to 21.689° , γ from 18.2° to 38.2° and δ from 22.357° to 42.357°) while β was kept constant at 90° due to design requirements. The results show that as α increases average torque output increases to a certain point after which it remains constant. On the contrary, as γ and δ increase, average torque output decreases. From the results, it can be concluded that the ideal blade angles, for optimal torque output, are $\alpha=11.689^\circ$, $\gamma=18.2^\circ$ and $\delta=22.357^\circ$.

Keywords: Vertical Axis Wind Turbine (VAWT), Computational Fluid Dynamics (CFD), Torque, Tip Speed Ratio

1. Introduction

In recent years, the development of new energy sources has been increasing significantly due to continued depletion and consequent rise in fossil fuel prices. A solution to the energy crisis is to find sustainable energy sources that are clean and cost-effective. Wind is one of such energy source that can be harnessed using wind turbines.

Generally, wind turbines can be categorised into two types i.e. Horizontal Axis Wind Turbines (HAWT) and Vertical Axis Wind Turbines (VAWT). From the late 1970s, a number of investigations have been carried out to improve the performance characteristics through design modifications in the Vertical Axis Wind Turbines (VAWT) using both experimental and numerical techniques. Baird et al. [1] conducted a series of wind tunnel experiments to measure the performance output of a small scale vertical axis wind turbine. Various blade shapes, with and without deflectors, have been analysed for their effectiveness in power generation from the VAWT. Pressure and power coefficients for 'S' shaped blades have been calculated and it is reported that the use of deflectors decreases the power output of the VAWT. Travis et al. [2] conducted numerical studies on the aerodynamic shape of conventional VAWT designs. In the above, differential evolution algorithms have been used with available Computational Fluid Dynamic (CFD) tool in order to minimise an objective function based on constraints that are represented by floating point values rather than binary strings. It has been established that optimised VAWT design shows a slight increase (1 - 2%) in the performance output of the VAWT. Colley et al. [3] conducted numerical studies to analyse the

effects of rotor blade positions on the performance output of a VAWT. In this particular study, Multiple Reference Frame (MRF) approach has been used to rotate the rotor blades of the VAWT. The results stated that torque output of the turbine decreases with an increase in rotor tip speed ratio (TSR) for relevant rotor blade positions. Furthermore, the findings also concluded that the VAWT power curve characteristics vary with relative rotor blade position. Wirachai [4] conducted a series of laboratory and field tests on various blade designs of Darrieus type VAWT. It has been reported that CFD is unable to predict the performance output of a VAWT accurately and hence it was recommended to have performance field tests. However, the accuracy of the modelling techniques incorporated for numerical simulations was not accurate. Therefore, a highly simplified model with very basic boundary conditions (trying to capture the transient phenomena) was used, which resulted in a very crude agreement between the published and CFD results. Manabu et al. [5] conducted experimental studies to analyse the effects of directed guide vanes on the performance output of a VAWT. The power coefficient and starting characteristics have been investigated in detail to analyse the effects of the angle and gap between the rotor blade and guide vane. It has been shown that use of directed guide vanes increased the peak coefficient of the VAWT considerably. Furthermore, it was also found that by increasing the stator blade angle increases the performance output of the VAWT. Soraghan et al. [6] conducted numerical studies using double multiple stream tube method to optimise the aerodynamic performance of a VAWT with straight blades. The study introduced a method of calculating effective lift to drag ratio based on averaged torque per cycle. It was shown that

solidity and conning angle of a VAWT had a significant impact on its optimal tip speed ratio and power generation. Furthermore, it has been demonstrated that an H-rotor with the same solidity as a V-rotor will operate optimally at a much lower rotational speed and attain a higher power coefficient.

From the reviewed literature it is noticed that optimal design of vertical axis wind turbines is very important as far as commercial viability of such machines is concerned. In this present study, numerical studies have been conducted to analyse the effect of the inlet and outlet angles of the rotor blades on the overall output performance of the vertical axis wind turbine.

2. Numerical Modelling

In order to analyse the effect of rotor blade angles on the performance characteristics of a VAWT, a three dimensional Vertical Axis Wind Turbine model, similar to Colley [7-9], has been numerically created as shown in figure 1. The outermost region is called Stator, the inner most is Core, and the one in-between these two is known as Rotor. The model comprises of 12 stator and rotor blades respectively; whereas the core region is normally a void region. The rotor blades rotate under the action of the incident wind, and hence produce torque. It can be seen from the figure that the numerical VAWT model has a stator diameter of 2m, rotor diameter of 1.4m, and the overall height of the VAWT is 1m.

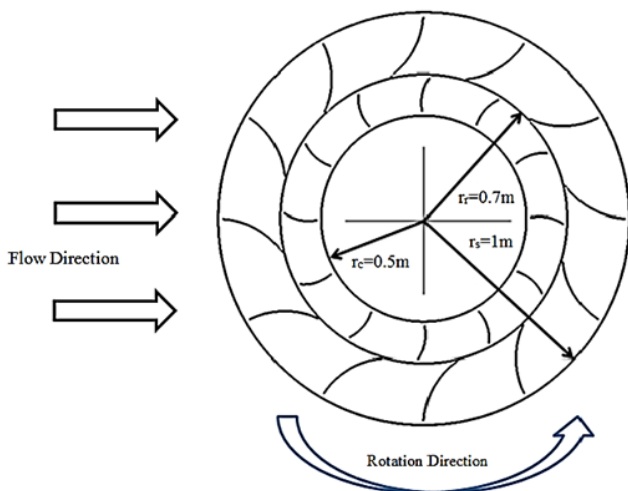

Figure 1. Vertical Axis Wind Turbine dimensions

In order to analyse the effect of the blade angles on the performance output of the VAWT, only specific range of blade angles has been chosen in the present study (α from 1.689° to 21.689° , γ from 18.2° to 38.2° and δ from 22.357° to 42.357°) while β has been kept constant at 90° due to design requirements i.e. the incident flow and the inlet of the stator blade should be perfectly aligned with each other. These blades angles are pictorially represented in figure 2. The range of blade angles has been chosen to be within operation envelope, considering the difficulties in the manufacturing of such blades and integration of these blades with an in-house built VAWT.

Figure 3 depicts the flow domain used in the simulation of wind flow around the VAWT. The length, width and the height of the flow domain are 13m, 9m and 3m respectively, and have been chosen such that the boundaries of the flow domain will not affect the flow features developed due to the interaction of the incident wind with the VAWT, and hence the resulting flow phenomena is preserved for analysis.

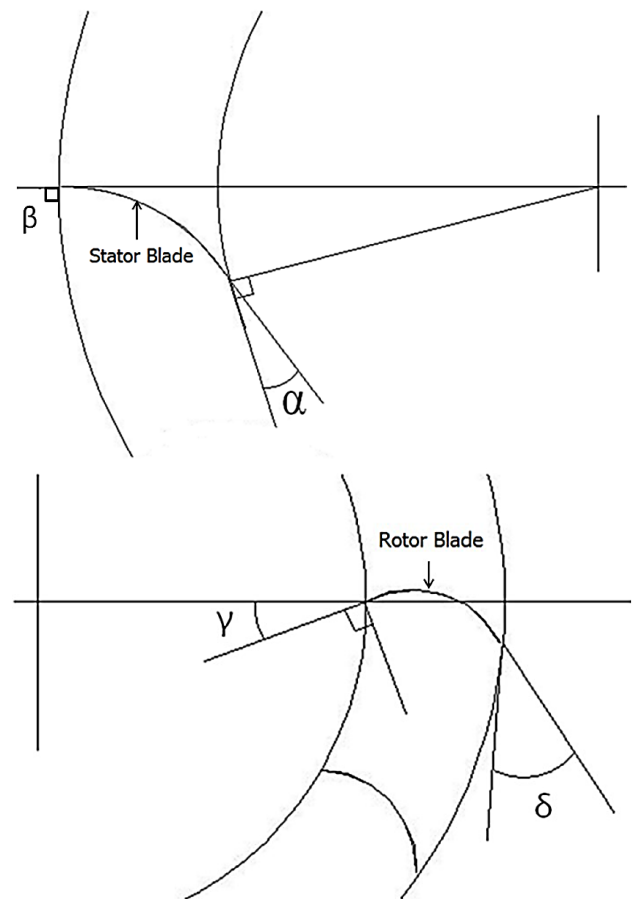

Figure 2. Blade angles of a Vertical Axis Wind Turbine

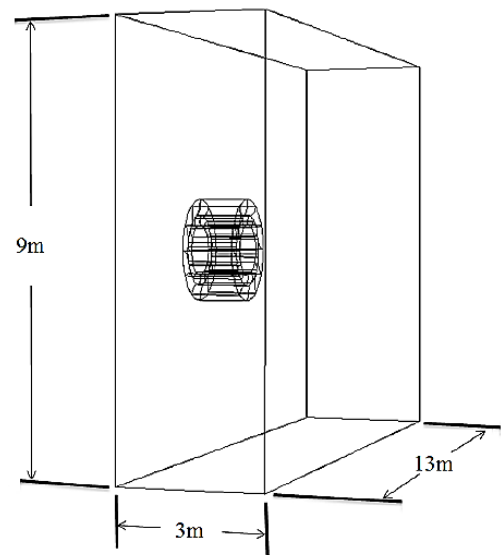

Figure 3. Dimensions of the Flow Domain

The flow domain, with the VAWT in it, has been sub-divided into discrete volumes called mesh elements. 1.7 million mesh elements, with concentration in the vicinity of the VAWT, has been generated in the present study. Mesh sensitivity analysis carried out in previous studies by Park et al [10-14] confirms that the mesh considered in the present study is capable of predicting the local flow features with reasonable accuracy, and hence the mesh independence studies have not been included in this article. The mesh within the VAWT has been depicted in figure 4.

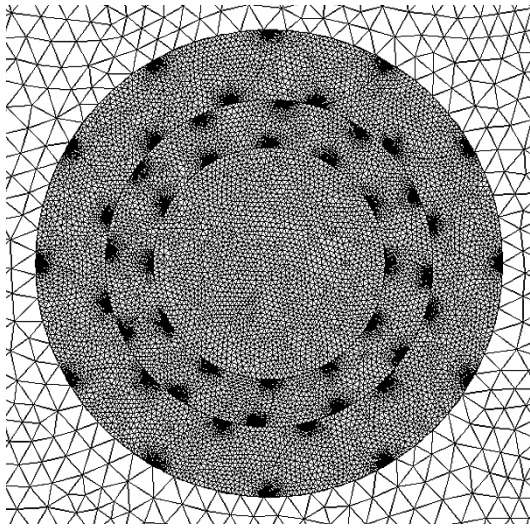

Figure 4. Mesh within the Vertical Axis Wind Turbine

The boundary types and conditions that have been specified are listed in the table 1. The incident flow is maintained at a constant velocity of 6m/s throughout this study since it is a practical wind speed value in urban environments. Tip Speed Ratio (λ) is also kept constant at 0.2 as it represents the most common operating condition for this type of wind turbines [10-14]. Atmospheric conditions at pressure outlet boundary means that zero gauge static pressure has been prescribed, which is expected in real world conditions. Furthermore, all the walls in the flow domain have been modelled as no-slip boundaries meaning that the flow does not slip on the surface of the walls.

Table 1. Boundary Types and Conditions

Boundary Name	Boundary Type	Boundary Condition
Inlet	Velocity Inlet	6m/s
Outlet	Pressure Outlet	Atmospheric conditions
Surrounding sides	Stationary Walls	No-Slip
Rotor Blades	Rotating walls	No-Slip
Stator Blades	Stationary Walls	No-Slip
Core & Passages	Interior	Interior

When a time-accurate solution for rotor-stator interaction (rather than a time-averaged solution) is desired, sliding mesh model should be used to compute the unsteady flow field. Hence, in the present study, Sliding Mesh technique has been used in order to rotate the rotor blades. The sliding mesh model is a very accurate method for simulating flows in multiple moving reference frames, but is also very computationally demanding, and hence, a 6-core hyper-threaded Intel CPU, with 3.6GHz frequency and 15MB Cache, has been used. The four cell zones numerically created have been joined together to form adjoining interfaces. The interface zones of adjacent cell zones are associated with one another to form a mesh interface. During the

numerical calculation, the rotor zone rotates relative to the other three zones (stator, domain and core) along the mesh interface in discrete steps. As the rotation takes place, node alignment along the mesh interface is not required. Since the flow is inherently unsteady, a time-dependent solution procedure is prescribed. This situation requires a means of computing the flux across the two non-conformal interface zones of each mesh interface.

The aforementioned discrete steps through which the rotor blades rotate are of great importance as far as the accuracy of the numerically predicted flow features are concerned. In the present study, these discrete steps have been specified such that each step corresponds to 3° angular rotation of the rotor blades; hence a complete revolution of the rotor comprises of 120 discrete steps. Park [15] has shown that a step size of 3° is capable of predicting the local transient flow phenomena with reasonable accuracy. The numerical simulations have been started from a predefined stator-rotor position identified as 0° angular position. Asim et al [16-18] has shown that, in case of Vertical Axis Turbines, the third revolution provides statistically steady results, which are free from numerical errors. Hence, the 3rd revolution of the VAWT has been considered in the present study as the test revolution.

The main objective of this research study is to numerically analyse the effect of blade angles on the torque output of a VAWT. Torque acting on the rotor blades has been computed using:

$$\text{Total Torque} = \text{Pressure Torque} + \text{Viscous Torque}$$

or:

$$\vec{T}_A = (\vec{s}_{AB} \times \vec{F}_P) + (\vec{s}_{AB} \times \vec{F}_V) \quad (1)$$

where A is the specified moment centre, B is the force origin, F_P and F_V are pressure and viscous force vectors acting on the rotor blades. These forces are computed as:

$$F_P = \oint P \hat{n} \cdot \hat{e}_d dS \quad (2)$$

and:

$$F_V = \oint \tau_w \hat{t} \cdot \hat{e}_d dS \quad (3)$$

where P is the normal pressure acting on the rotor blades, τ_w is the wall shear stress acting on the rotor blades, n is the unit vector perpendicular to the surface of the rotor blades, t is the unit vector parallel to the surface of the rotor blades, e_d is the unit vector parallel to the flow direction and dS is the surface area of the rotor blades. Shahzad et al [19] observed that the pressure torque has the major contribution towards total torque for VAWTs.

In the present study, the effect of the blade angles (two rotor angles and one stator angle) on the torque output of the VAWT has been analysed, and novel prediction models proposed for the performance output of the VAWT.

3. Results and Discussions

The following sub-sections comprises of numerical results obtained from a commercial CFD solver. The instantaneous and average torque outputs from various VAWT configurations (based on blade angles) have been presented. Novel prediction models for the prediction of torque output have been developed.

3.1. Effect of stator blade angle α on the performance output of the VAWT

Numerical analysis has been carried out on the VAWT model for five different α angles, and keeping the γ and δ angles constant at 18.2° and 32.357° respectively. In this way the effect of α angle alone on the performance output of the VAWT can be analysed. Figure 5 depicts the static pressure variations in the vicinity of the VAWT for $\alpha=1.689^\circ$. The results show that there is a high pressure region, going up to 39.5Pa(g) , on the windward side of the VAWT; whereas, the pressure is lower on the leeward side of the VAWT; decreasing upto -30.1Pa(g) . Furthermore, the pressure is comparatively lower on the upper section of the VAWT due to the orientation of the blades. This indicates that the rotor blades on the lower windward side of the VAWT are responsible for producing maximum torque output.

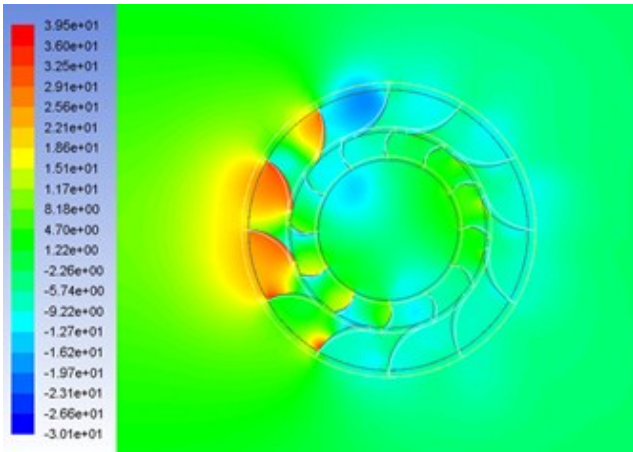

Figure 5. Pressure variations at 0° angular position of the VAWT having $\alpha=1.689^\circ$, $\gamma=18.2^\circ$ and $\delta=32.357^\circ$

In order to quantify the performance output of the VAWT considered here, the instantaneous torque output for one revolution of the VAWT has been plotted in figure 6. It can be seen that the torque output of the VAWT is cyclic with the number of peaks/valleys equal to the number of rotor and stator blades. Furthermore, the highest and lowest instantaneous torque values are 23.81N-m and 19.33N-m , averaging to 21.93N-m .

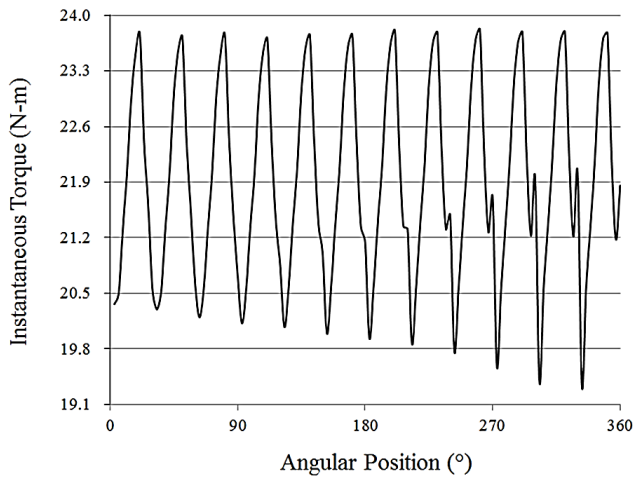

Figure 6. Instantaneous torque output of the VAWT having $\alpha=1.689^\circ$, $\gamma=18.2^\circ$ and $\delta=32.357^\circ$

Table 2 and figure 7 depict that as α angle increases, the average torque output of the VAWT also increases to a certain point. After that, further increase in α angle has negligible effect

on the average torque output of the VAWT. Therefore, there is an optimum value of α that corresponds to the maximum performance output of the VAWT, which in the present study is 11.689° .

Table 2. Average torque output of the VAWT for various α

α	Average Torque	Percentage Difference in Average Torque Output
$(^\circ)$	(N-m)	(%)
1.689°	21.93	
6.689°	22.94	4.6
11.689°	23.53	2.5
16.689°	23.64	0.4
21.689°	23.57	-0.2

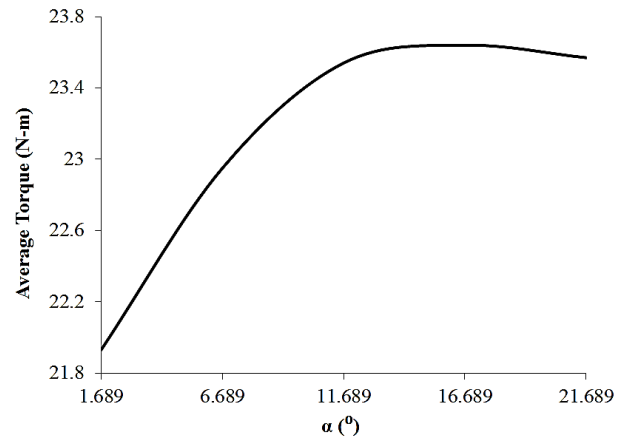

Figure 7. Effect of α on the performance output of VAWT

In order to utilise the information provided here, it is necessary to first define the coefficient of torque, which is expressed as follows:

$$C_T = \frac{2T}{\rho A R V^2} \quad (4)$$

where T is the average torque output of the VAWT, ρ is the density of air, A is the frontal area of the VAWT, R is the radius of the rotor blades computed from the axis of rotation and V is the wind velocity. The coefficient of torque can be expressed in terms of α using advanced statistical tools, such as multiple variables regression analysis, as:

$$C_T = 9.2 \left(\frac{\alpha}{\beta}\right)^3 - 8.1 \left(\frac{\alpha}{\beta}\right)^2 + 2.06 \left(\frac{\alpha}{\beta}\right) + 1.56 \quad (5)$$

It can be seen that the third order polynomial expression has been used to express torque coefficient as a function of stator blade angle α . The accuracy of this expression, for determining torque coefficient values within the range mentioned in the present study, is above 99%. Hence, equation (5) can be used with equation (4) in order to compute the average torque output of a VAWT, as a function of α angle. This novel predictor expression can be very useful to VAWT designers as it provides a user-friendly tool for the estimation of the performance output of the VAWT. However, it should be noted that this predictor expression is only valid within the range of α angles considered in the present study. Further studies need to be carried out in order to develop a generic predictor expression that covers a wider range of blade angles.

3.2. Effect of rotor blade angle γ on the performance output of the VAWT

Numerical analysis has been carried out on the VAWT model for five different γ angles, and keeping the α and δ angles constant at 11.689° and 32.357° respectively. The α angle of 11.689° is the optimum stator blade angle. Figure 8 depicts the static pressure variations in the vicinity of the VAWT for $\gamma=18.2^\circ$. The results show that there is a high pressure region, going up to 38.9Pa(g) , on the windward side of the VAWT whereas the pressure is lower on the leeward side of the VAWT; decreasing upto -28.2Pa(g) . Although the flow field looks very similar to the one observed in figure 5, however, the higher pressure limit has reduced by 1.5%, and the lower pressure limit has decreased by 6.3% respectively. This suggests that the effect of γ is less severe than the effect of α on the performance output of the VAWT. However, this needs to be investigated in more depth.

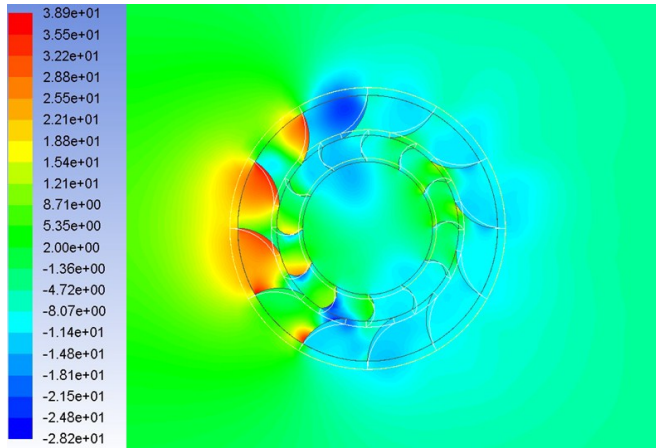

Figure 8. Pressure variations at 0° angular position of the VAWT having $\gamma=18.2^\circ$, $\alpha=11.689^\circ$ and $\delta=32.357^\circ$

Figure 9 depicts the instantaneous torque output of the VAWT for the configuration considered here. The torque signals are cyclic, as observed in figure 6; however, the scale is different. The maximum and minimum instantaneous torque outputs for one complete revolution of the VAWT are 26.29N-m and 22.50N-m respectively, averaging to 24.17N-m . Hence, the maximum, minimum and average torque outputs have increased by 2.48%, 3.17% and 10.21% respectively as compared to the VAWT configuration considered in the previous sub-section.

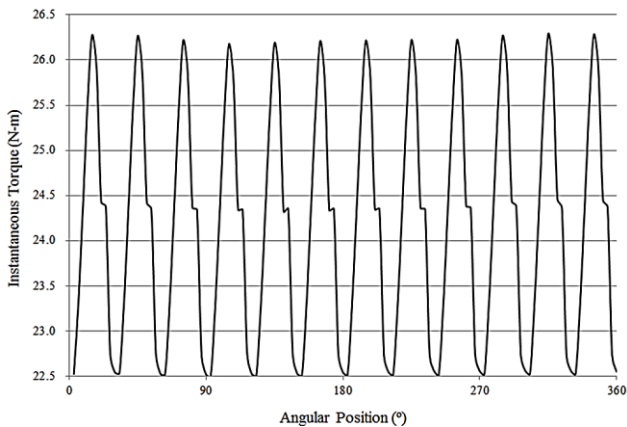

Figure 9. Instantaneous torque output of the VAWT having $\gamma=18.2^\circ$, $\alpha=11.689^\circ$ and $\delta=32.357^\circ$

The aforementioned observations do not clearly indicate the effect of γ on the performance output of the VAWT because the

case considered in the previous sub-section had a different α angle as compared to the one considered here. Hence, there is a need to explicitly analyse the effect of γ angle on VAWT's performance.

Table 3 and figure 8 depict explicitly that as γ increases the average torque output decreases. However, there are two distinct regions that can be identified. The first region, which corresponds to lower γ values, has a lower gradient, however, the second region, with higher γ values, has a higher gradient. Hence, from $\gamma=18.2^\circ$ to 28.2° , the decrease in torque output is not significantly large, which explains the discussions in the first paragraph of this sub-section; however, from $\gamma=28.2^\circ$ onwards, the decrease in the torque output of the VAWT is considerable, which explains the second paragraph of this sub-section. Hence, lesser the γ angle of the rotor blades, higher the performance output of the VAWT. For the range of γ angles considered in the present study, the optimum γ angle, which corresponds to the maximum torque output, is $\gamma=18.2^\circ$.

Table 3. Average torque output of the VAWT for various γ

γ	Average Torque (N-m)	Percentage Difference in Average Torque Output (%)
18.2°	24.17	
23.2°	23.94	-0.95
28.2°	23.53	-1.71
33.2°	21.51	-8.58
38.2°	20.38	-5.25

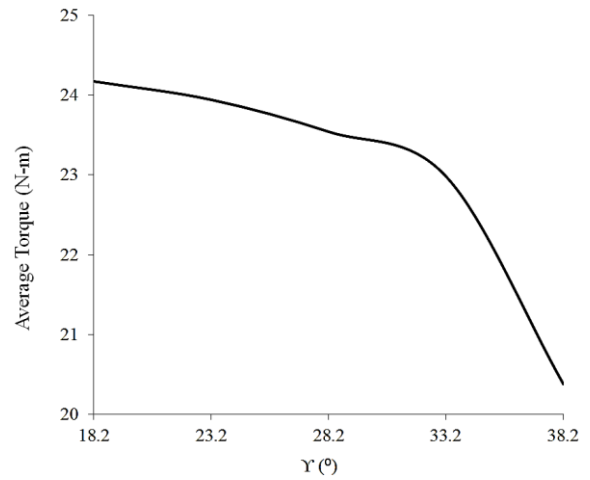

Figure 10. Effect of γ on the performance output of VAWT

The coefficient of torque can be expressed in terms of γ as:

$$C_T = -602.5 \left(\frac{\gamma}{\beta}\right)^4 + 688.9 \left(\frac{\gamma}{\beta}\right)^3 - 292.7 \left(\frac{\gamma}{\beta}\right)^2 + 54.2 \left(\frac{\gamma}{\beta}\right) - 1.9 \quad (6)$$

It can be seen that the fourth order polynomial expression has been used to express torque coefficient as a function of rotor blade angle γ . The accuracy of this expression, for determining torque coefficient values within the range mentioned in the present study, is above 99%. Hence, equation (6) can be used with equation (4) in order to compute the average torque output of a VAWT, as a function of γ angle. This predictor expression is only valid within the range of γ angles considered in the present study. Further studies need to be carried out in order to develop a generic predictor expression that covers a wider range of blade angles.

3.3. Effect of rotor blade angle δ on the performance output of the VAWT

Numerical analysis has been carried out on the VAWT model for five different δ angles, and keeping the α and γ angles constant at 11.689° and 18.2° respectively. The α and γ angles are the optimum blade angle as discussed previously. Figure 11 depicts the static pressure variations in the vicinity of the VAWT for $\delta=22.357^\circ$. The results show that there is a high pressure region, going up to 39.1Pa(g) , on the windward side of the VAWT whereas the pressure is lower on the leeward side of the VAWT; decreasing upto -29.1Pa(g) . Hence, the variations in the maximum static pressure limits, compared to figures 5 and 8, are negligibly small. However, the variations in the minimum static pressure limit are -3.19% and 3.32% respectively, indicating that the minimum static pressure has reduced as compared to figure 5, and has increased as compared to figure 8.

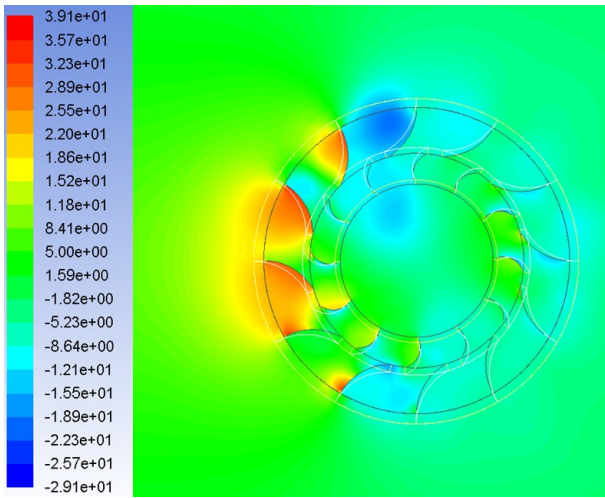

Figure 11. Pressure variations at 0° angular position of the VAWT having $\delta=22.357^\circ$, $\alpha=11.689^\circ$ and $\gamma=18.2^\circ$

Figure 12 depicts the instantaneous torque output of the VAWT for the configuration considered here. The torque signals are cyclic, as observed in figures 6 and 9; however, the scale is different. The maximum and minimum instantaneous torque outputs for one complete revolution of the VAWT are 25.94N-m and 24.05N-m respectively, averaging to 25.01N-m . Hence, the maximum, minimum and average torque outputs have increased by 8.95% , 24.41% and 14.04% respectively as compared to the VAWT configuration considered in sub-section regarding effects of α angle, and by -1.33% , 6.88% and 3.47% respectively as compared to the VAWT configuration considered in sub-section regarding effects of γ angle.

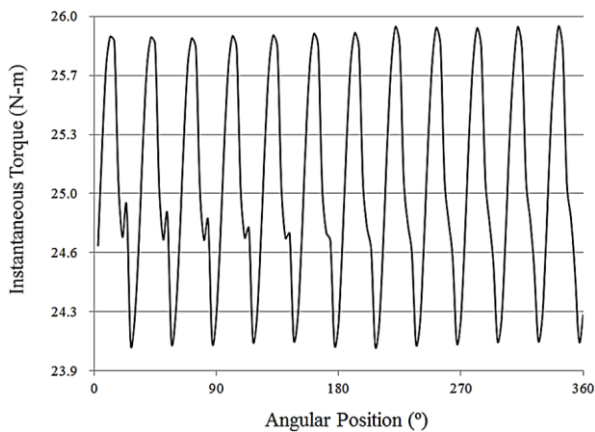

Figure 12. Instantaneous torque output of the VAWT having $\delta=22.357^\circ$, $\alpha=11.689^\circ$ and $\gamma=18.2^\circ$

Table 4 and figure 13 depict that as δ increase, the average torque output decreases constantly. Hence, lesser the δ angle of the rotor blades, higher the performance output of the VAWT. For the range of δ angles considered in the present study, the optimum δ angle, which corresponds to the maximum torque output, is $\delta=22.357^\circ$.

Table 4. Average torque output of the VAWT for various δ

γ	Average Torque	Percentage Difference in Average Torque Output
$(^\circ)$	(N-m)	(%)
22.357°	26.37	
27.357°	26.40	-0.11
32.357°	26.29	-0.41
37.357°	25.79	-1.90
42.357°	25.19	-2.32

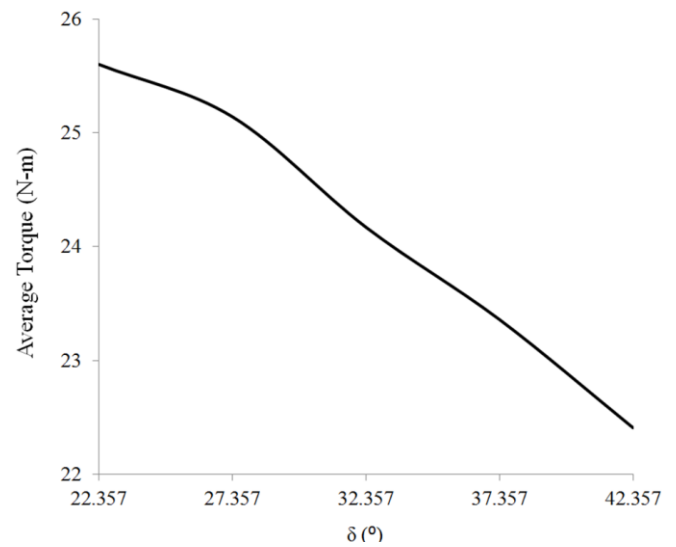

Figure 13. Effect of δ on the performance output of VAWT

The coefficient of torque can be expressed in terms of δ as:

$$C_T = -1.38 \left(\frac{\delta}{\beta}\right)^2 - 0.07 \left(\frac{\delta}{\beta}\right) + 1.97 \quad (7)$$

It can be seen that the second order polynomial expression has been used to express torque coefficient as a function of rotor blade angle δ . The accuracy of this expression, for determining torque coefficient values within the range mentioned in the present study, is above 99%. Hence, equation (7) can be used with equation (4) in order to compute the average torque output of a VAWT, as a function of δ angle. This predictor expression is only valid within the range of δ angles considered in the present study. Further studies need to be carried out in order to develop a generic predictor expression that covers a wider range of blade angles.

4. Optimal VAWT Design

After carrying out detailed numerical analysis on the performance output of various VAWT configurations, the optimal VAWT design, based on blade angles considered in the present study, is the one with $\alpha=11.689^\circ$, $\gamma=18.2^\circ$ and $\delta=22.357^\circ$. Figure 14 depicts the static pressure variations in

the vicinity of the optimal VAWT. The maximum static pressure limit is 38.2Pa(g), whereas the minimum static pressure limit is -28.4Pa(g).

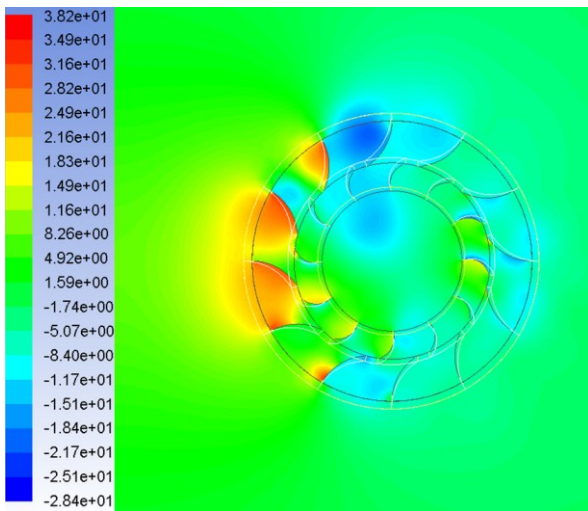

Figure 14. Pressure variations at 0° angular position of the Optimal VAWT

Figure 15 depicts the instantaneous torque output of the optimal VAWT design. The maximum, minimum and average torque outputs are 26.41N-m, 24.8N-m and 25.67N-m respectively. The average torque output of the optimal VAWT configuration is higher than average torque values observed earlier.

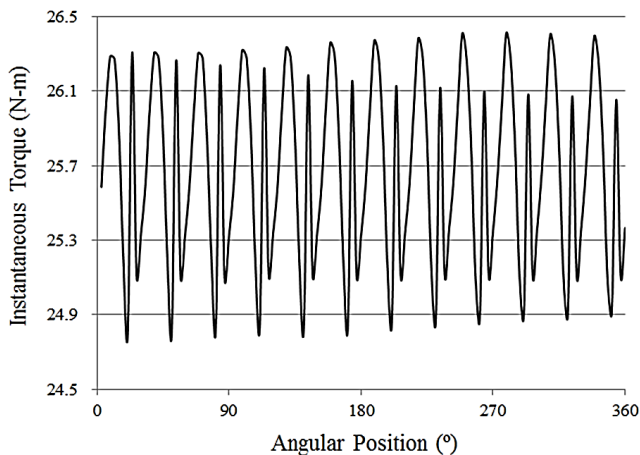

Figure 15. Instantaneous torque output of the Optimal VAWT

5. Conclusions

In this study, the effects of various blade angles of a Vertical Axis Wind Turbine on its performance output have been numerically examined and analysed. Detailed discussions on the static pressure variations in the vicinity of the VAWT have been presented. Instantaneous torque output signals for various configurations of the VAWT have been monitored for one complete revolution of the VAWT. Furthermore, Average torque output from these VAWT models have been noted down.

It has been shown that the pressure field in the vicinity of the VAWT is highly unsymmetrical and non-uniform due to the orientation of the rotor blades with respect to the stator blades. Windward side of the VAWT has higher pressure regimes as compared to the leeward side. The instantaneous

torque output of the VAWT consists of a number of peaks and valleys which are equal to the number of blades of the VAWT. It has been explicitly shown that the increase in the stator blade angle increases the torque output of the VAWT upto a certain limit, after which there is no significant change in the torque output. As far as the rotor blade angles are concerned, increase in rotor blade angles decreases the torque output of the VAWT.

Novel prediction models have been developed in the present study that shows the torque coefficient of the VAWT as a function of blade angles. These predictor expressions have been found to be highly accurate within the range considered in the present study. These novel prediction models can help the VAWT designers immensely in order to develop such VAWT designs that yield maximum torque output from the VAWT.

Optimal VAWT model, based on maximum torque output, has been identified and its instantaneous torque output signals analysed, clearly showing maximum performance characteristics. It has been shown in the present study that Computational Fluid Dynamics based codes/solvers are capable of predicting both the local and global flow features with reasonable accuracy, and hence CFD can be integrated with the design and analysis processes of wind turbine farms.

References

1. Baird, J. P. Pender, S. F. (1980) Optimisation of a Vertical Axis Wind Turbine for Small Scale Applications, 7th Australasian Hydraulics and Fluid Mechanics Conference, 18 – 22 August, Brisbane, Australia.
2. Travis, J. C. (2010) Aerodynamic Shape Optimisation of a Vertical Axis Wind Turbine, M.Sc. Thesis, University of Texas at Arlington, U.S.A.
3. Colley, G. Mishra, R. Rao, H. V. Woolhead, R. (2010) Effect of rotor blade position on Vertical Axis Wind Turbine performance, International Conference on Renewable Energies and Power Quality, (ICREPPQ'10), 23 – 25 March, Granada, Spain.
4. Wirachai, R. (2004) Optimisation of Vertical Axis Wind Turbines, M.Sc. Thesis, School of Engineering and Technology, Northumbria University, U.K.
5. Manabu, T. Hideki, K. Takao, M. Yasunari K. Michiaki, O. Atsushi, M. (2009) A Straight-bladed Vertical Axis Wind Turbine with a Directed Guide Vane Row Effect of Guide Vane Geometry on the Performance, Journal of Thermal Science, vol. 18, pp. 54 – 57.
6. Soraghan, C. Leithead, W. Jamieson, P. (2013) Influence of Lift to Drag Ratio on Optimal Aerodynamic Performance of Straight Blade Vertical Axis Wind Turbines, European Wind Energy Association Annual Conference, Vienna, Austria.
7. Colley, G. (2013) Design, Operation and Diagnostics of a Vertical Axis Wind Turbines, Ph.D. Thesis, University of Huddersfield, U.K.
8. Colley, G. Mishra, R. (2011) Computational flow field analysis of a Vertical Axis Wind Turbine, International Conference on Renewable Energies and Power Quality, (ICREPPQ'10), 13 – 15 April, Las Palmas de Gran Canaria, Spain.
9. Colley, G. Mishra, R. (2011) Performance characteristics of a Vertical Axis Wind Turbine (VAWT) under transient conditions, 24th International Congress on Condition Monitoring and Diagnostics Engineering Management, Stavanger, Norway.

10. Park, K. Asim, T. Mishra, R. (2012) Computational Fluid Dynamics based Fault Simulations of a Vertical Axis Wind Turbine, *Journal of Physics: Conference Series*, vol. 364.
11. Park, K. Asim, T. Mishra, R. (2012) Simulations based approach to predict Vertical Axis Wind Turbine faults using Computational Fluid Dynamics, 1st International Conference on Through-Life Engineering Services, 5 – 6 November, Bedfordshire, U.K.
12. Park, K. Asim, T. Mishra, R. Pradhan, S. (2012) Condition based monitoring of Vertical Axis Wind Turbines using Computational Fluid Dynamics, 39th National Conference on Fluid Mechanics and Fluid Power, 13 – 15 December, Surat, India.
13. Park, K. Asim, T. Mishra, R. Shahzad, A. Marangwanda, G. (2012) Computational Fluid Dynamics based performance optimisation of Vertical Axis Marine Current Turbines, 2nd International Workshop and Congress on eMaintenance, 13 – 14 December, Lulea, Sweden.
14. Park, K. Asim, T. Mishra, R. (2013) Effect of blade faults on the performance characteristics of a Vertical Axis Wind Turbine, 26th International Congress of Condition Monitoring and Diagnostic Engineering Management, 11 – 13 June, Helsinki, Finland.
15. Park, K. (2013) Optimal design of a micro Vertical Axis Wind Turbine for sustainable urban environment, Ph.D. Thesis, University of Huddersfield, U.K.
16. Asim, T. Mishra, R. Ubbi, K. Zala, K. (2013) Computational Fluid Dynamics based optimal design of Vertical Axis Marine Current Turbines, *Procedia CIRP*, vol. 11, pp. 323 – 327.
17. Shahzad, A. Asim, T. Mishra, R. Paris, A. (2013) Performance of a Vertical Axis Wind Turbine under Accelerating and Decelerating Flows, *Procedia CIRP*, vol. 11, pp. 311 – 322.
18. Asim, T. Mishra, R. Ubbi, K. (2013) Effect of the shape of Stator blades on the performance output of a Vertical Axis Wind Turbine. 26th International Congress on Condition Monitoring and Diagnostic Engineering Management, 11 – 13 June, Helsinki, Finland.
19. Shahzad, A. Asim, T. Park, K. Pradhan, S. Mishra, R. (2012) Numerical simulations of effects of faults in a Vertical Axis Wind Turbine's performance, 2nd International Workshop and Congress on eMaintenance, 13 – 14 December, Lulea, Sweden.