



# University of HUDDERSFIELD

## University of Huddersfield Repository

Raharjo, Parno, Abdusslam, S.A., Gu, Fengshou and Ball, Andrew

Vibro-Acoustic Characteristic of A Self Aligning Spherical Journal Bearing due to Eccentric Bore Fault

### Original Citation

Raharjo, Parno, Abdusslam, S.A., Gu, Fengshou and Ball, Andrew (2012) Vibro-Acoustic Characteristic of A Self Aligning Spherical Journal Bearing due to Eccentric Bore Fault. In: CM 2012 and MFPT 2012: The Ninth International Conference on Condition Monitoring and Machinery Failure Prevention Technologies, 12th - 14th June 2012, London, UK. (Unpublished)

This version is available at <https://eprints.hud.ac.uk/id/eprint/14202/>

The University Repository is a digital collection of the research output of the University, available on Open Access. Copyright and Moral Rights for the items on this site are retained by the individual author and/or other copyright owners. Users may access full items free of charge; copies of full text items generally can be reproduced, displayed or performed and given to third parties in any format or medium for personal research or study, educational or not-for-profit purposes without prior permission or charge, provided:

- The authors, title and full bibliographic details is credited in any copy;
- A hyperlink and/or URL is included for the original metadata page; and
- The content is not changed in any way.

For more information, including our policy and submission procedure, please contact the Repository Team at: [E.mailbox@hud.ac.uk](mailto:E.mailbox@hud.ac.uk).

<http://eprints.hud.ac.uk/>

# Vibro-Acoustic Characteristic of A Self Aligning Spherical Journal Bearing due to Eccentric Bore Fault

P. Raharjo, S. Abdussalam, F. Gu and A. D. Ball  
School of Computing and Engineering, University of Huddersfield,  
Queensgate, Huddersfield, HD1 3DH, UK  
E-mail: Parno.Raharjo.U0874514@hud.ac.uk

## Abstract

Self aligning spherical journal bearing is a type of plain bearings which has spherical surface contact. This type of bearing can accommodate a misalignment problem. The journal bearing faults degrade machine performance, decrease life time service and unexpected failure which are dangerous for safety issues. Surface vibration (SV), airborne sound (AS) and acoustic emission (AE) measurements are appropriate monitoring methods for early stage journal bearing fault in low, medium and high frequency.

This paper focuses on the performance comparison between SV, AS and AE measurements in the self aligning spherical journal bearing with normal and eccentric bore faults. The dynamics of the bearing is studied to gain the generation and characteristics of SV, AS and AE, which allow the extraction of useful information for diagnosis. The results of SV, AS and AE experiments especially for self-aligning spherical journal bearing due to eccentric bore fault indicate that the spectrum can detect significantly distinct between normal and faulty bearing. The statistic parameters show that RMS value and Peak value for fault bearing is higher than normal bearing. Spectrum of SV, AS and SE showed significant differences between normal bearing and eccentric bore bearing.

*Keyword: Self aligning spherical journal bearing, Fault diagnosis, Surface vibration, Airborne sound, Acoustic-emission, Eccentric bore.*

## 1. Introduction

Journal bearings are considered superior to rolling element bearings in high load capacity, vibration absorption, shock resistance, quietness, and long life. All these characteristics come from the journal bearing principle of supporting a shaft by a thin oil film <sup>(1)</sup>. However, mixed and boundary lubrications are inevitable in the processes of machine start and stop, or under severe working conditions, such as insufficient lubricant supply, high operating temperature, and heavy loading. These inadequate conditions will cause high abrasive wear or scratching. Gradually, the wear removes more materials on the surface of bearing bore in the direction of applied load and to lead early failure of bearings.

Previous study has shown that most machinery problems are caused by bearing failure, with over 40% of motor failures in machines of 75kW power or more, due to bearing problems <sup>(2)</sup>. In addition, Flood showed that 13% of all mechanical seal failures are the consequence of distress that originated with bearing problems <sup>(3)</sup>.

Many condition monitoring techniques have been investigated to detect bearing faults at early stage, so that the catastrophic failures can be avoided. Vibration analysis is one of the most commonly used CM techniques in industry because it has advantages of generating relevant data in a quantitative format and remote real-time operating.

Ahmadi and Mollazade used vibration condition monitoring technique for bearing fault diagnosis of mine stone crusher and the result indicates that it is effective for machine faults prediction and diagnosis <sup>(4)</sup>. Choy and his companion successfully used vibration monitoring to identify and quantify bearing damages in rolling bearing <sup>(5)</sup>. Shiroishi succeeded in

detecting damages of the outer race on rolling bearing by combining the high frequency resonance technique (HFRT) and adaptive line enhancer (ALE) in vibration analysis <sup>(6)</sup>. Vibration monitoring is also applied to monitor and diagnostic reciprocating engine <sup>(7)</sup> for rotating machine <sup>(8)</sup> and electrical motor <sup>(9)</sup> in industry. DeCamillo and his companion had done an investigation of a journal bearing journal characteristic but with tilt-pad type <sup>(10)</sup>. However, these vibration monitoring studies give relatively little information regarding the application in the journal bearing especially for self aligning spherical journal bearing.

Acoustic or sonic analysis is the measurement of sound pressure waves generated by component contact inside equipment and radiated from the surface of the machine. Its application in industry for monitoring bearing faults is relatively new <sup>(11)</sup>. Airborne sound (AS) of journal bearing is generated by mechanical such as contacts between journal or shaft and bearing. Sound also can be generated by hydrodynamic. AS are characterized by their amplitude or loudness and frequency. Airborne sound has been used to determine the noise level of a place or a factory, but rarely for engine condition monitoring, for example noise monitoring on aircraft <sup>(12)</sup> and acoustic monitoring on diesel engine <sup>(13)</sup>, however these research is used for noise control for healthy, safety and comfortable purposes.

Acoustic emission (AE) may be used to investigate or measure the transient elastic energy wave that is generated from a rapid strain energy caused by deformation or damage within or on the surface. Dickerhof et al. investigated lubrication regimes in sliding bearing using acoustic emission. They reported that acoustic emission analysis is an appropriate measurement procedure to detect incipient failure at sliding bearing with correlation between the emitted acoustic signal and the energy dissipated in the sliding metallic contact <sup>(14)</sup>. Actually, acoustic emission exists widely in various fields in the industry. It can be used to detect and estimate for rolling bearings defects <sup>(15)</sup>. Halford and his friends used the AE technique for cracks detection in aircraft construction <sup>(16)</sup>.

The previous studies of surface vibration, airborne acoustic and acoustic emission monitoring on bearings still shown relatively small information that can be obtained, also it has not be found a comprehensive condition monitoring a particular for self aligning spherical bearing journal. This paper focuses on surface vibration, airborne sound and acoustic emission which are appropriate to detect the bearing condition in low frequency, middle frequency and high frequency due to eccentric bearing bore. The eccentric bore journal bearing can be caused by wearing. When the wear increases, the asperity contact also increases, which will induce higher responses in vibro-acoustics and acoustic emission.

## **2. Vibro-Acoustics characteristics of journal bearings**

The vibro-acoustics of journal bearings have been studied by several researchers <sup>(17)</sup> for the purposes of vibration control. Abdo has investigated the relationship between micro contact friction induced vibration and noise, the result indicates that micro contact or asperity contact gives effect on vibration and noise characteristic of mechanical system with friction contact <sup>(18)</sup>. The micro contact in the friction process can be represented by a spring damper model <sup>(19)</sup>. To measure and analyse the vibro-acoustics accurately, the main characteristics are overviewed for fault diagnosis based on a self aligning spherical journal bearings as shown in Figure 1, which has a casting bronze sleeve and cast iron housing.

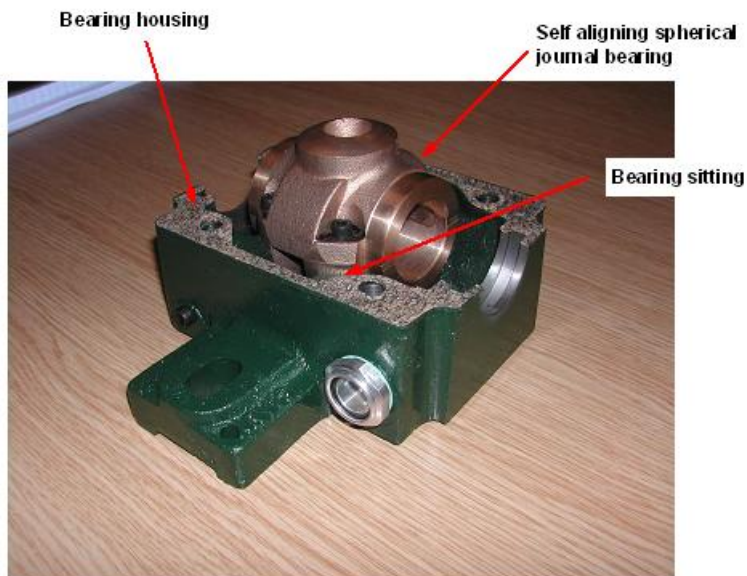

**Figure 1. Self-aligning spherical journal bearing components**

### **2.1 Surface vibration source**

The micro contact or asperity contact in an idealized intersection between bearing surfaces under radial load  $F$ , speed  $n$ ,  $b$  wide of contact and  $L$  is length of bearing can be characterised dynamically by micro springs and dampers. As shown in Figure 2, each spring-damper set represents a pair of asperity contact.

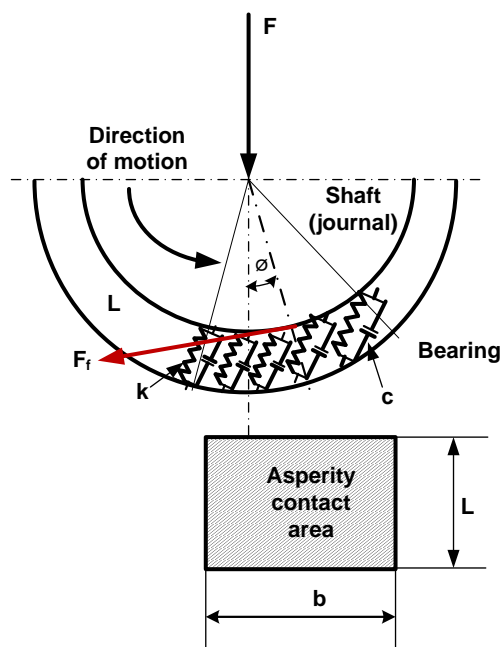

**Figure 2. Vibration schematic of a journal bearing due to asperity contact**

Generally, the dynamic motion of shaft supported by the journal bearing can be described by the following equation

$$[M]\{\ddot{y}\} + [C]\{\dot{y}\} + [K]\{y\} = \{F_f\} \dots\dots\dots(1)$$

Where  $[M]$  is the equivalent mass matrix,  $[C]$  is the viscous damping matrix,  $[K]$  is the matrix of system stiffness or rigidities and  $\{F_f\}$  is the Friction force vector acting between journals and bearing. While  $\{\ddot{y}\}$ ,  $\{\dot{y}\}$  and  $\{y\}$  are the vector acceleration, velocity and displacement respectively of the equivalent mass.

The friction force acting in the system is taken in general form as:

$$\{F_f\} = \mu_h (\{F_{sn}\} + \{F_{dn}\}) \dots\dots\dots(2)$$

Where  $\mu_h$  is the hydrodynamic micro contact friction coefficient and  $\{F_{sn}\}$  and  $\{F_{dn}\}$  are the static and dynamic normal forces respectively. The static normal force applied by radial external force at the contact between journal and bearing can be expressed as:

$$F_{sn} = F \cdot \cos(\phi) \dots\dots\dots(3)$$

Where  $F$  and  $\phi$ , are the external radial force and angular displacements of the shaft and displacement of the bearing. The dynamic normal force caused by the vibration between journal and bearing can be expressed as <sup>(20)</sup>.

$$F_{dn} = K_b (x_s - x_b) \dots\dots\dots(4)$$

Where  $x_s$  and  $x_b$  are the displacement of the shaft and displacement of the bearing.  $K_b$  is the local contact stiffness.

Micro contact friction coefficient of a randomly distributed rough surface can be formulated by <sup>(21)</sup>.

$$\mu_h = \frac{4}{3} \cdot \eta \cdot A \cdot E' \cdot \beta^{\frac{3}{2}} \cdot \sigma^{\frac{1}{2}} \cdot \int_h^\infty (\varepsilon - h)^{\frac{3}{2}} \cdot \Phi^*(\varepsilon) \cdot d\varepsilon \dots\dots\dots(5)$$

Where  $\eta$  is the surface density asperities,  $A$  is the nominal contact area,  $E'$  is the equivalent of modulus elasticity of two materials,  $\beta$  is the asperity radius,  $\sigma$  is the standard deviation of asperity height distribution,  $\varepsilon = z/\sigma$  is the normalized asperity heights,  $h = d/\sigma$  is the normalized separation,  $\Phi^*(\varepsilon)$  is the normalized asperity height distribution.

From above analysis, vibration responses of a self aligning journal bearing relates to the external load, mass, sliding velocity, lubricant viscosity, surface asperity characteristics and material of the bearing. External forces affect the vibration responses at low and high frequency. The external force is directly related to the system. While for high frequency range, the external forces associated with the tangential friction forces that occur at the contact between the journal and bearing. Therefore, if the external force increases the amplitude of surface vibration at low frequency and also at high frequency rises as well.

The surface vibration response at low frequency and high frequency are also affected by the shaft speed. At low frequency range, shaft speed influences the vibration frequency due to centrifugal force that be caused by unbalance problem. At high frequency, shaft speed vibration affects the frequency, sliding velocity and hydrodynamic friction coefficient. When the shaft speed increases the vibration response at low frequency will increase due to unbalance centrifugal force. At high frequency when the shaft speed increases, the vibration response will fluctuate depend on the regime lubrication system.

Lubricant used in general machinery and especially the journal bearing influence Vibro-acoustic response. Lubricant viscosity influences the damping coefficient and stiffness. The stiffness and damping coefficient affects the vibration system. Lubricant viscosity determines the oil film thickness of lubricant and will determine the asperity contact area between journal and bearing. By using a lubricant with a higher viscosity, the damping coefficient and an oil film thickness will increase and the asperity contact area decreases therefore the vibration response at low and high frequency tends to decrease.

The journal bearing under higher external load and speed will cause higher vibration amplitude. If the bearing uses a lower viscosity of lubricant it will result in the depletion of oil film and increase the asperity area or multi-asperity contact. Contact time for a single pointed asperity can be very fast. Therefore, the vibration response occurs at high frequency in random signals.

## 2.2 Acoustic Emission source

AE is the phenomenon of transient elastic wave generation in a material under stress. When materials are subjected to stress above a certain level, a rapid release of strain energy takes places in the form of elastic waves which can be detected by an AE transducer.

The sources of AE signals generated by mechanical loading and failure of materials include such friction effects as plastic deformation, change in surface structure and appearance of wear debris and formation of fatigue pits. Journal bearings reduce friction for really heavy shafts in sliding contact, therefore AE signal analysis may be of use in detecting journal bearing early failure.

When two solid bodies are in contact with each other, the true contact between them occurs at only a limited number of points. The pressures on those points are very high and this asperity contact was found to be the main acoustic emission source in sliding friction <sup>(22)</sup>. The two components of a bearing are usually separated to a certain degree by a lubricant film. If the lubricant film is thick enough to fully separate the components' surfaces, then the friction coefficient is reduced and that results in longer bearings life.

AE analysis is an appropriate measurement to detect incipient failure of sliding bearings because of the correlation between emitted acoustic signal and energy dissipated in the sliding metallic contact, resulting in substantial increase of the signal amplitude in the frequency range around 100 kHz. Damage or failure can be recognized independently by contact geometry, sliding speed, shell and lubricant temperatures <sup>(14)</sup>. There will be a relationship between AE and power loss; if the increase in AE signal is due to increased asperity contact there will be increased friction and increased power loss <sup>(23)</sup>.

The release rate of the energy of elasticity in the journal bearing can be written as <sup>(24)</sup> with cylinder to cylinder contact.

$$\dot{E}_e = 0.07 \cdot A \cdot n_a \cdot V \cdot W \cdot \left[ \frac{W}{E' \cdot L \cdot R'} \right]^{\frac{1}{2}} \left[ \frac{2}{3} + \ln \left( \frac{4 \cdot R_1 \cdot R_2}{b^2} \right) \right] \dots \dots \dots (6)$$

Where  $\dot{E}_e$  is the release rate of the energy of elasticity,  $A$  is the Asperity contact area,  $n_a$  is the number of asperity or asperity areal density,  $V$  is the sliding motion velocity,  $W$  is the Radial load,  $E'$  is the Equivalent elasticity modulus of two materials,  $L$  is a half length of bearing,  $R'$  is the Equivalent radius of cylinder,  $R_1$  is the shaft or journal radius,  $R_2$  is the bearing bore radius, and  $b$  is a half width of two cylinder contact.

The acoustic emission energy magnitude is influenced by external load, component materials, roughness or asperity, geometrical occurrence and lubricant viscosity. The increasing of these parameters may create the acoustic emission energy amplitude increase except for lubricant viscosity.

### 2.3 Airborne sound source

Sound is produced by every vibrating component of a machine or item of equipment, and travels as a wave through the surrounding air to reach the listener. Sound is a variation in local pressure in a medium that moves or transmits through the material at a speed which depends on the properties of the material. Noise produced by a machine or item of equipment may indicate the problems and need for maintenance <sup>(25)</sup>.

Sound or noise can be evaluated both quantitatively and qualitatively. Quantitatively would be an overall measure of the sound level, qualitatively would include temporal and spectral characteristics. The quantitative level would be an indication of the presence of a fault and the qualitative measures would locate the fault. The acoustic transducer would usually be a microphone.

Noise from the machinery or rotating equipment can be aerodynamic, electromagnetic and structural or mechanical noise, with every component generating noise at a specific frequency corresponding to its natural frequencies <sup>(26)</sup>.

In industry, aerodynamic noise is most commonly generated by pneumatic discharge systems, blow-off nozzles and leaking high pressure lines. However, aerodynamic noise also occurs when there is a large relative velocity between a solid object and the surrounding air, e.g. fan blades. The acoustic power generated is determined largely by the speed of the solid object. However, other factors can be important such as when the blades of a fan or pump pass a solid object and the fundamental frequency is the blade passing frequency.

Electromagnetic noise is produced by electromagnetic force that generate from the interaction between magnetic and the electrical supply in the electromotor. The magnetic noise amplitude appears at twice that of the electrical line frequency.

Structural noise is generated by mechanical vibration. Bearings are a major cause of such mechanical noise and this will be exacerbated if faults are present, e.g. lack of lubrication, misalignment, rotor unbalance and rubbing between bearing stator and bearing rotor. The production of hydrodynamic pressure within the journal bearing also generates noise. Noise is also generated by friction. Friction on two different materials contact surface in sliding motion influences the energy of noise and vibration <sup>(27)</sup>.

In a journal bearing the shaft rotate within the bearing. In this bearing oil is used to decrease the friction and prevent metal to metal contact between shaft and bearing. The shaft and bearing surface are not perfectly smooth, and when the shaft rotates in the bearing it will create a scraping or rubbing noise without an adequate layer of lubricating oil. However, the generation of hydrodynamic oil pressure in the journal bearing also creates noise. In the journal bearing, sound or acoustic wave travels in the radial direction from the component outwards through the lubricant (fluid), the bearing housing (solid) and the surrounding air.

For a long journal bearing, the pressure distribution is given by the following equation <sup>(28)</sup>.

$$p(\theta) = \frac{6\eta.V.R}{c^2} \cdot \frac{\varepsilon(2 + \varepsilon \cdot \cos \theta) \cdot \sin \theta}{(2 + \varepsilon^2)(1 + \varepsilon \cdot \cos \theta)^2} \dots\dots\dots(7)$$

Where  $\eta$  is the viscosity dynamic of lubricant,  $V$  is the linear velocity of shaft,  $R$  is the radius of shaft,  $c$  is the radial clearance,  $\epsilon$  is the eccentricity ratio, and  $\theta$  is the contact angle.

### 3. Test rig and experiment procedure

The monitoring of the surface vibration, sound acoustic and AE characteristics of a self-aligning spherical journal bearing with eccentric bore for early fault diagnosis require a test rig. The test rig consists of an electrical motor drive, torque load system, measurement and data acquisition systems, hydraulic ram, hand pump, the self-aligning spherical journal bearing, load cell and main drive shaft and flexible hard rubber coupling. The torsion load was applied by a 9.9 kW DC generator placed at the end of the rig.

The AC electrical drive motor 12.5 kW, 3-phase, 4-pole electric induction motor with maximum speed 1460 rpm was connected to the main test rig and DC generator by a hard rubber coupling. The test rig was equipped with one accelerometer to measure the vibration signal, one microphone to measure the near field acoustic signal and one AE sensor for each bearing as shown in Figure 3.

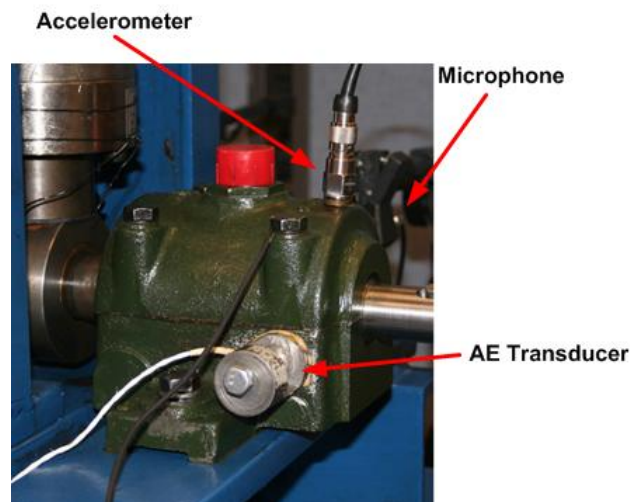

**Figure 3. Accelerometer, microphone and AE sensor installations**

A Park 690 AC drive with Siemens Micro Master Controller was installed so that the motor could be run at different speeds and different torsion load.

Two SA35M of self-aligning spherical journal bearings to be tested are mounted at the drive end (DE) for fault bearing and non-drive end (NDE) for reference bearing.

A Global Sensor Technology YE6232B, 16-channel, 16-bit, DAS system was employed to record all the measurements at a sampling rate of 96 kHz. The data was send to Mathlab<sup>TM</sup> for analysis, diagnosis and interpretation.

The accelerometers attached to the test rig were Global Sensor Technology model CA-YD-185TNC. They were attached on the DE and NDE bearing with frequency range 0.5 Hz to 5000 Hz and sensitivity 4.96mV/m/s<sup>2</sup>. The accelerometers were attached to the bearing housing casing by a threaded bronze stud. The vibration transducers were connected to DAS and then to the computer via a USB port separately.

The acoustic sensor or microphone was used to measure the airborne sound radiated from journal bearing to its surrounding. The microphones were GST model BAST YG 201 07067 for the DE bearing and model BAST YG 201 07065 for the NDE bearing with 20Hz to 100



kHz  $\pm$  0.2 dB range and 50 mV/Pa. The microphones were placed 200 mm away behind accelerometer pick up. The microphone was directly connected to the DAS and then connected with the computer by USB.

The AE sensor was an Acoustic Emission sensor, Physical Acoustic Corporation, Acoustic Group WD SN AJ64. The output signal from AE -sensor was pre-amplified by 40 dB, type wideband AE Sensor, sensor name WD, sensor S/N FQ35, maximum value -64.50 dB, peak frequency 263,67 kHz and sensitivity dB ref 1V/ $\mu$ bar. The AE sensor was connected to the AE data acquisition system AWin<sup>TM</sup> for PCI2 version E1.55 through pre-amplified by 40 dB.

The surface vibration, airborne sound and acoustic emission experiment were done by comparing the two journal bearings under same radial load, speed with different condition of bearings. The first bearing was a self-aligning spherical journal bearing (DE bearing) with eccentric bore fault and the second bearing (NDE bearing) was a normal bearing as reference.

The experiments were conducted under constant torsion load 10%, 351.7N radial load and at speed variation 20%, 40%, 60%, and 80% speed. Power maximum of motor is 11kWatt. The bearing was lubricated by specified lubricant of ISO VG 46.

Time-domain, frequency-domain and speed correlation analysis were carried out to identify effective detection features from the signals. The RMS, peak value, peak factor and kurtosis of the signal were used to evaluate the vibration signal. In the frequency-domain, trending, descriptive and comparative analysis was also used.

The fault examined in this research is an eccentric bore which is common due to wearing at early stage. Figure 4 shows the detail of a 0.2 mm seeded eccentric bore fault on a self aligning spherical journal bearing.

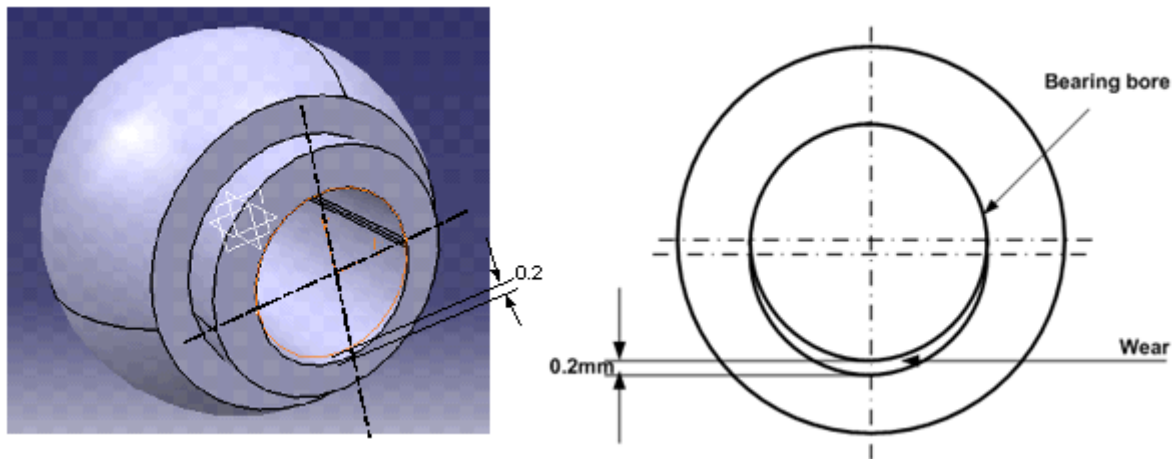

**Figure 4. Self aligning spherical journal bearing with 0.2mm eccentric bore**

#### **4. Result and discussion**

The results of experiment are grouped into surface vibration, airborne and acoustic emission measurements. The analysis used time domain, spectrum, trending, comparative and statistical analysis parameters such as RMS value and Peak value.

#### 4.1 Surface vibration measurement results

Figure 5 represents the surface vibration comparison response of a normal bearing and bearing with eccentric bore fault in time domain under 10% torsion load, 351.7N radial loads at 100% speed. The Figure shows that the difference between the amplitude of surface vibration signal on normal and eccentric bore journal bearing fault is quite significant.

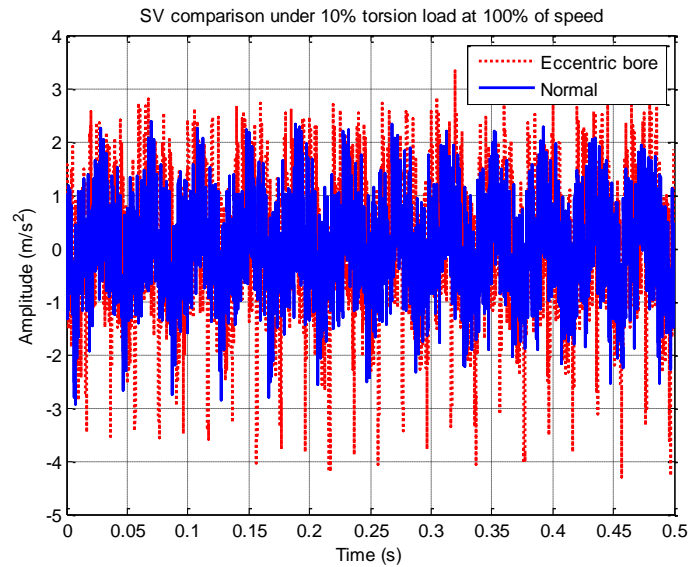

**Figure 5. SV signal comparison between normal and eccentric bore fault under 10% torsion load at 100% speed**

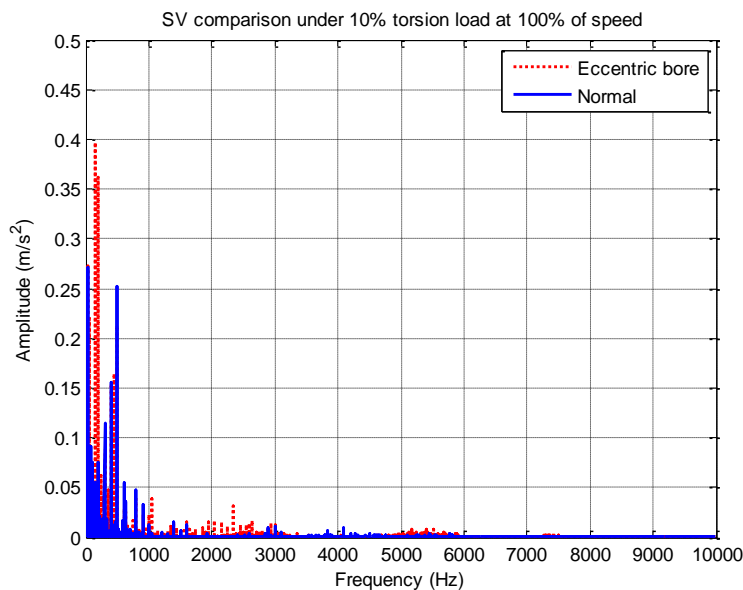
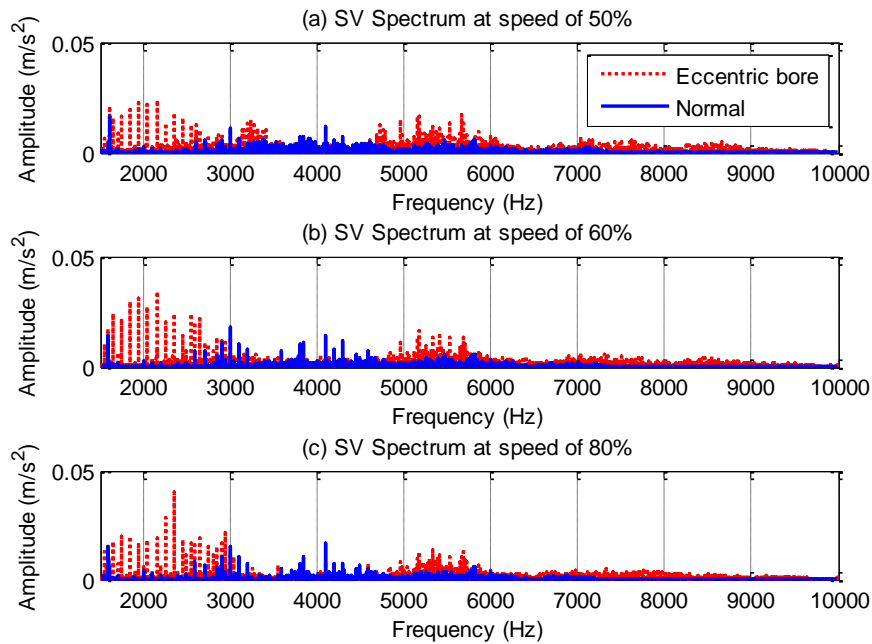

**Figure 6. SV spectrum comparison between normal and eccentric bore fault up to 10000Hz**

Figure 6 represents surface vibration spectrum under under 351.7N, 10% torsion load at 100% of speed at frequency up to 10000Hz show dominant high amplitudes at frequency less than 1500Hz. However, at high frequency also interesting signal is risen but in low

amplitude. The SV spectrum analysis is done at high frequency greater than 1000Hz up to frequency. The SV spectrum response at low frequency is usually caused unbalance, looseness, misalignment and installation faults. The SV spectrum response at high frequency is caused by wear and asperity contact process. Therefore SV spectrum analysis is done at high frequency from 1000Hz to 10000Hz.

Figure 7 shows the frequency domain response of surface vibration on eccentric bore and normal of self aligning spherical journal bearing under 351.7N radial load, 10% torsion load at 50%, 60% and 80% of speed at high frequency 1000Hz to 10000Hz



**Figure 7. SV spectrum comparison between normal and eccentric bore fault**

Figure 7 indicates that there is clear difference amplitude between normal and eccentric bore fault bearing. The surface vibration amplitude appear at frequency 1000Hz to 10000Hz. The high amplitude concentrates at frequency 2000Hz, 4000Hz and 5500Hz. The amplitude at frequency range from 1000Hz to 10000Hz may originate from wear and asperity contact due to eccentric bore fault problems

Figure 8 shows SV spectrum comparison between normal bearing and eccentric bore bearing fault in dB units which also gives clarification that there is significant different amplitude at any frequency between normal and fault bearing.

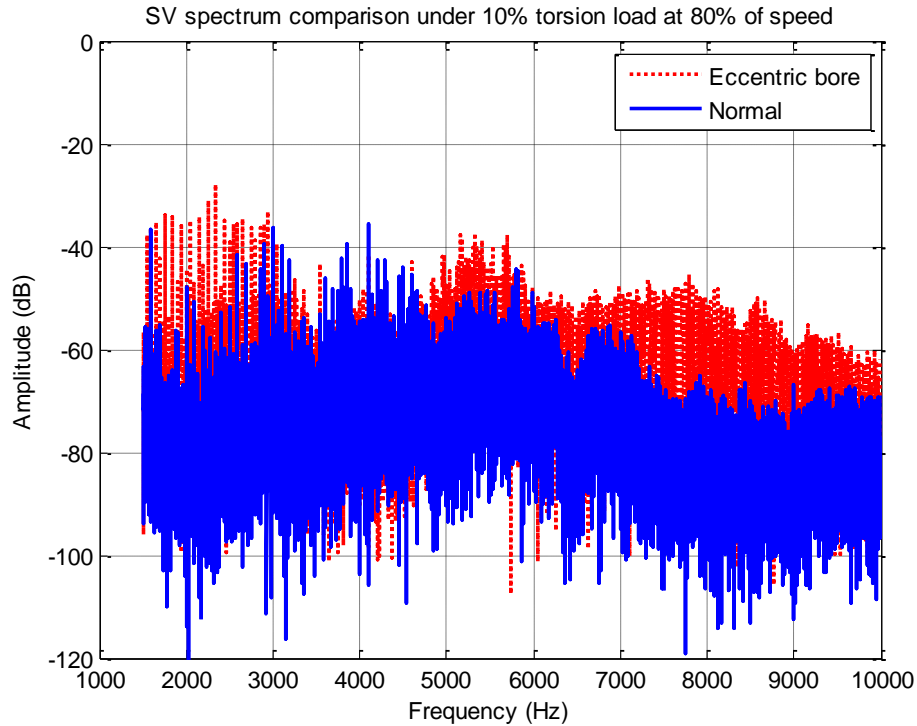

**Figure 8. SV spectrum comparison between normal and eccentric bore fault**

The SV spectrum comparative analysis in scratched self aligning spherical journal bearing also obtained that there was significant difference between scratched and normal bearing. This phenomenon is similar to the spectrum comparative in the eccentric bore fault. The scratched bearing experiment indicated that the high amplitude of SV is dominant at frequency 6.5kHz until 4.5kHz. While the eccentric bore fault experiment showed that the high amplitude of SV occurs at two frequency ranges from 1kHz up to 3kHz and between 3kHz up to 4.5kHz.

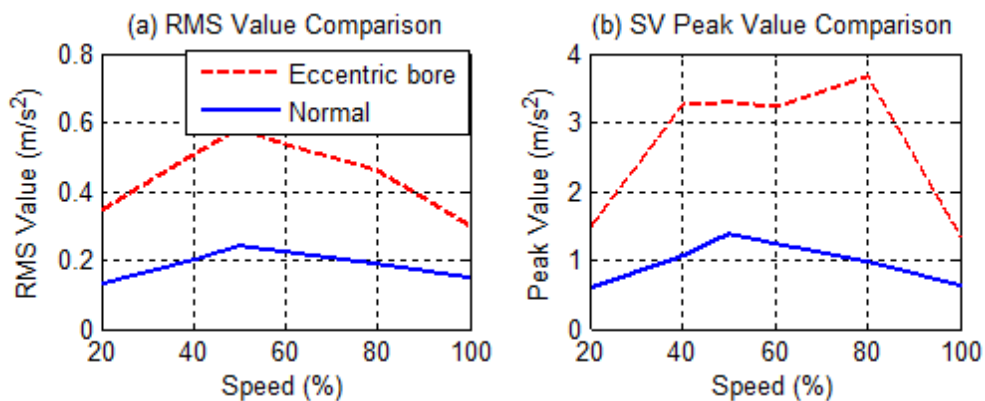

**Figure 9. SV RMS and Peak value comparison between normal and seeded eccentric bore fault**

Figure 9 represents a correlation between speed fluctuating and RMS value and Peak value of the surface vibration waveform of eccentric bore fault and normal bearing. The Figure shows that SV RMS value of the eccentric bore fault bearing is greater than RMS value of normal bearing. The Peak value indicates a similar indicator to RMS value.

#### 4.2 Airborne sound measurement result

The airborne-sound characteristic of self-aligning spherical journal bearing with eccentric bore fault was conducted under constant torsion load 10%, 351.7N radial load and at speed variation of 20%, 40%, 50%, 60%, 80% and 100% speed. The bearing was lubricated with specified lubricant ISO VG 46. The microphones are placed 200 mm from bearing housing.

Time-domain, frequency-domain and speed correlation were used for analysis. The time-domain, RMS value and Peak value of the signal were used to evaluate the airborne sound signal. In the airborne sound frequency-domain, descriptive and comparative analysis was also used. Figure 10 is a result of airborne sound signal measurement on the normal journal bearing and eccentric bore fault that operated under torsion load of 10% and 351.7N radial load at speed 100%.

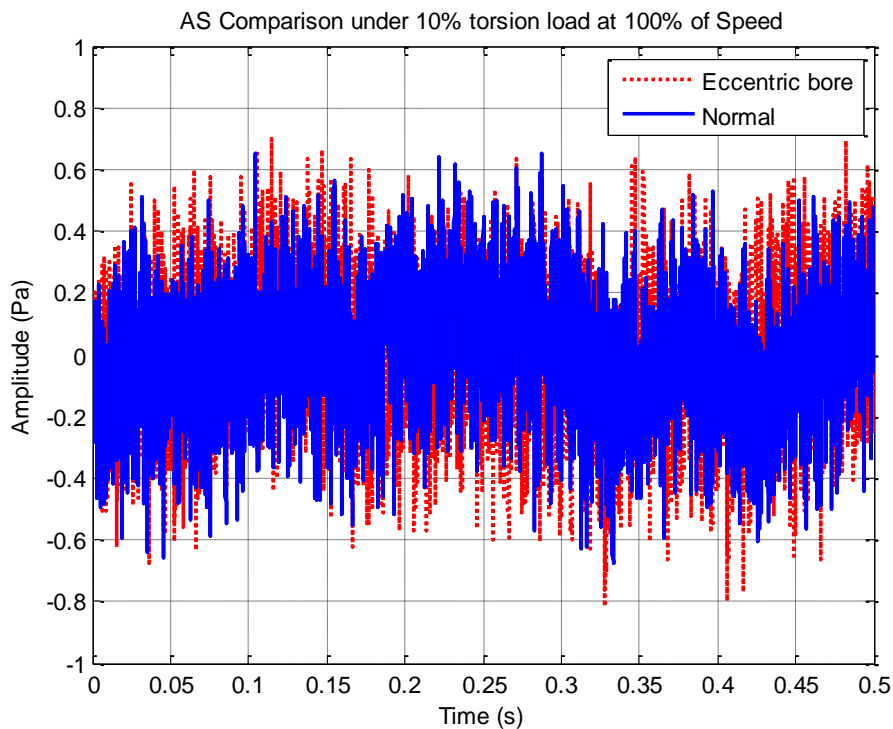

**Figure 10. AS signal comparison between normal and eccentric bore fault at 80% speed**

Figure 10 shows that the signal amplitude difference between the normal and faulty journal bearings is insignificant.

Figure 11 represents the airborne sound spectrum in frequency domain obtained information. A significant amplitude difference lies at a wide range frequency between 1500Hz and 10000Hz. The high amplitude appears dominant at frequency around 5500Hz. The amplitude may originate from wear and asperity contact due to eccentric bore fault problems. This phenomenon is similar to the SV response.

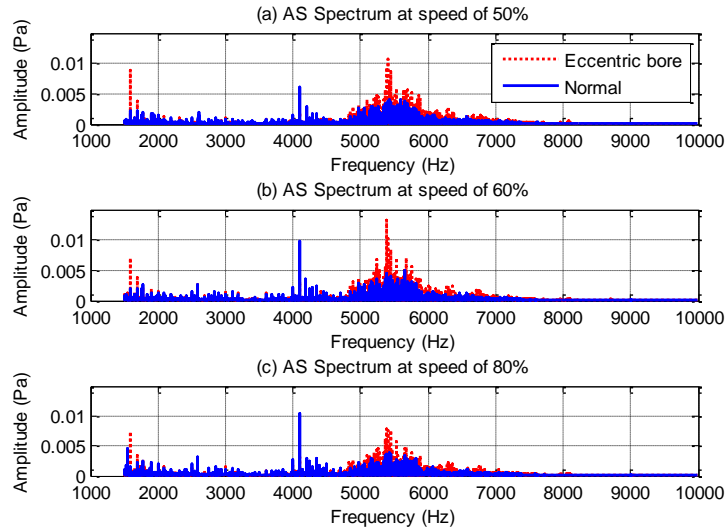

**Figure 11. Airborne Sound spectrum comparisons between normal and eccentric bore fault**

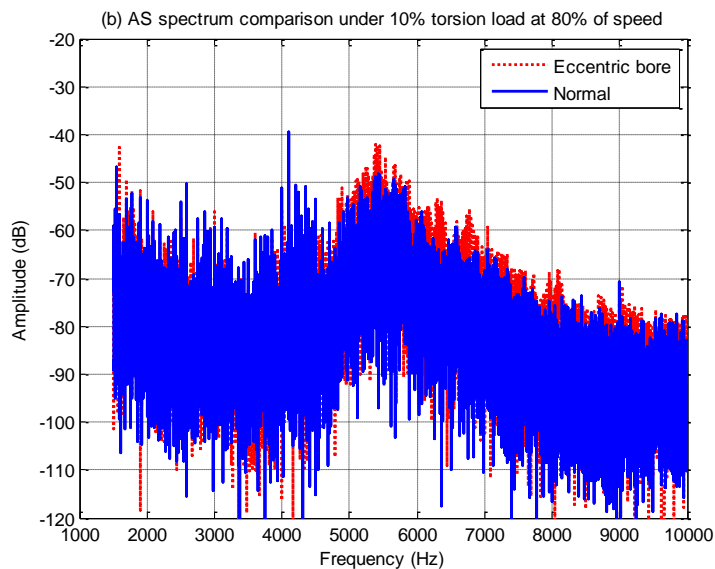
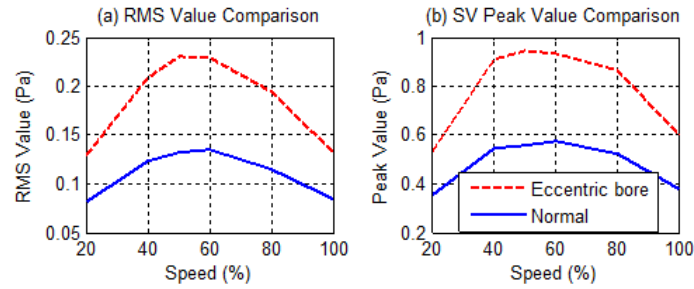

**Figure 12. Airborne Sound spectrum comparisons between normal and eccentric bore fault**

Figure 12 is AS spectrum comparison in dB unit under 10% torsion loads and 351.7N radial load at 80% of speed, that also shows there is a quite significant amplitude in any range of frequency.

The different frequency distribution between AS of eccentric bore and scratching bearing fault is at frequency range. The high AS amplitude in eccentric bore fault occur at frequency range from 4.5 kHz up to 7.0Hz, while the high AS amplitude in scratching bearing appear at frequency range 4.75 kHz up to 6.25 kHz.

Figure 13 illustrates the statistics parameter analysis of the waveform that has been showed in Figure 10. The Figure explains that the airborne sound RMS value and Peak value of the eccentric bore bearing fault are always higher than the normal bearing's at different speed. The Figure also indicates that when speed increases the RMS and Peak value also increase.



**Figure 13. AS RMS and peak value comparison between normal and eccentric bore bearing fault**

#### 4.3 Acoustic emission measurement result

The acoustic emission characteristic of self-aligning spherical journal bearing with eccentric bore bearing fault investigation was conducted under constant torsion load 10% of the maximum value and 351.7N radial load at variable speeds of 20%, 40%, 50%, 60%, 80% and 100% speed. The bearing was lubricated with specified lubricant ISO VG 46.

Figure 14 represents the comparison AE signal response between normal bearing and eccentric bore bearing fault in time-domain under 10% torsion load and 351.7N radial load at 100% speed. The Figure indicates that there is a significant difference between AE signal in time domain between the normal and faulty bearings.

The statistics parameter analysis such as RMS value and Peak value of the signal were used to evaluate influence of speed on the AE amplitude. The frequency-domain, descriptive and comparative analysis were also used.

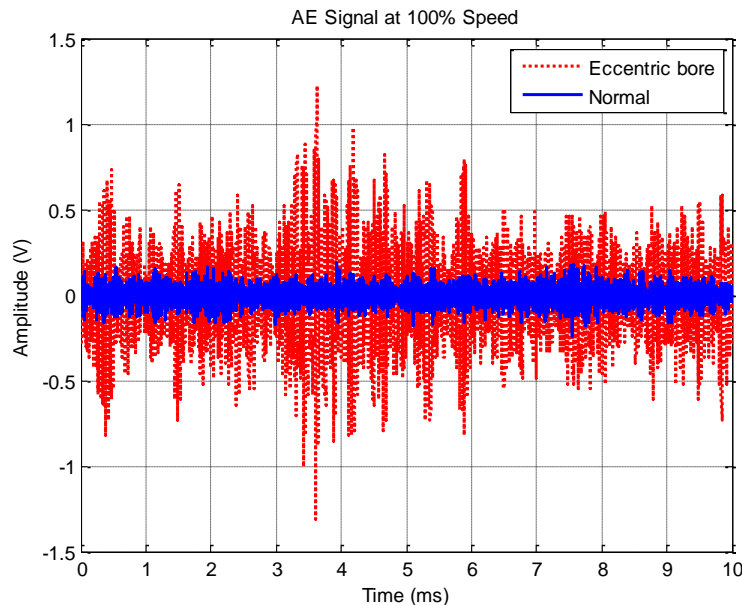

**Figure 14. AE Signal comparisons between normal and eccentric bore bearing fault**

Figure 14 shows the AE signal, the difference between AE amplitude of the normal and eccentric bore faulty bearings is significant. This information will be clarified in the AE frequency domain comparison between normal and faulty bearings.

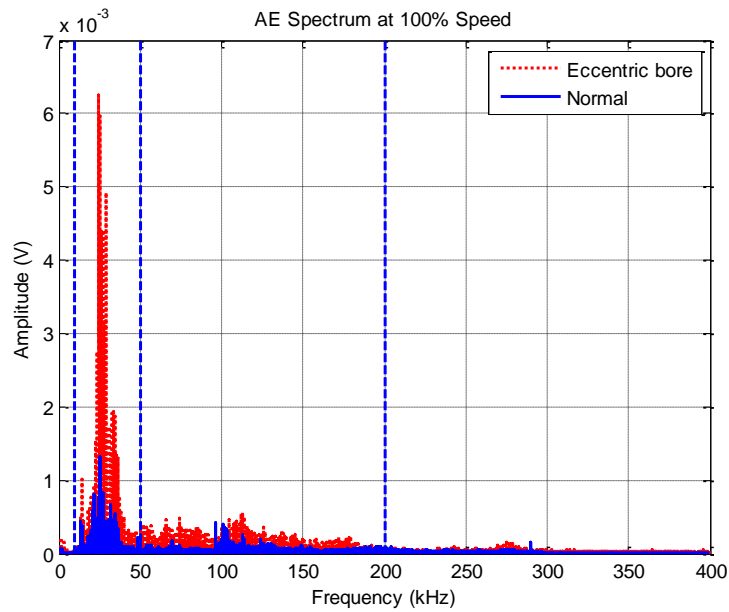
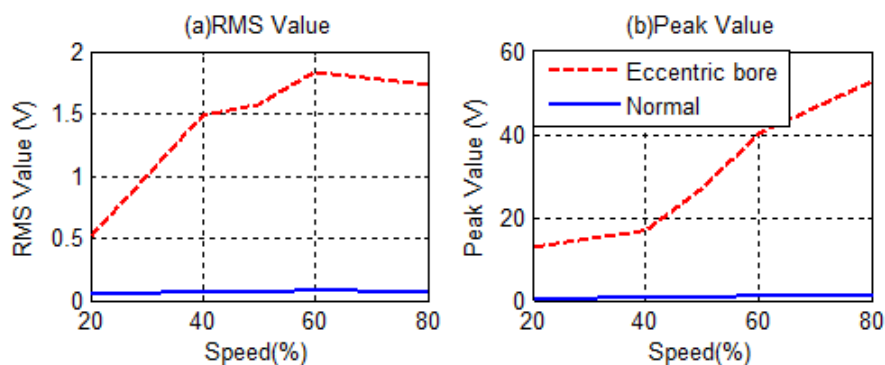

**Figure 15. AE Spectrum comparisons between normal and eccentric bore bearing fault**

The AE spectrum shows that there is a significant difference between both conditions. From the AE spectrum pattern, it seems that the AE high amplitude occurs at frequency range between 10 kHz to 50 kHz followed by frequency range between 50 kHz to 200 kHz, while the highest amplitude of spectrum appears predominant around a frequency range of 25 kHz. In addition, the amplitude of AE spectrum is higher than normal bearing amplitude at any frequency.

The AE spectrum analysis in eccentric bore and scratched bearing fault shows a similar pattern. The highest amplitude of AE spectrum in both conditions appears at frequency range about 25 kHz.

The effect of speed to AE RMS value and Peak value on healthy and eccentric bore journal bearing can be seen in Figure 16.



**Figure 16. AE RMS and Peak value comparison between normal and eccentric bore bearing faults**

Figure 16 reveals that the AE RMS value and AE Peak value of eccentric bore bearing fault are much higher than the healthy bearing's and when the speed increases the AE RMS and AE Peak value also increase.



## 5. Conclusion

This paper focused on the comparison of detection performance between SV, AS and AE measurements from a self aligning spherical journal bearing under healthy and eccentric bore fault. From the investigation the conclusions can be drawn as follows:

1. The differences of three signals in the high frequency range are quite significant between the normal and faulty conditions.
2. The surface vibration amplitude due to eccentric bore faults occurs in a frequency range from 1500Hz to 10000Hz and the highest amplitudes are at a frequency range of 2500Hz.
3. The airborne sound amplitude due to faulty bearing appears at frequency range of 1500Hz up to 10000Hz and dominant high amplitude occurs at frequency range of 5500Hz.
4. The pattern of AE spectrum seems to have high amplitude occurs at frequency ranges between 10 kHz up to 50 kHz followed by 50 kHz up to 300 kHz and the highest amplitude of spectrum occurs around frequency range of 25 kHz.
5. The RMS and Peak value of SV, AS and AE spectrum for eccentric bore faults increases with shaft speeds but remains higher than that of normal case.
6. The SV, AS and AE monitoring methods can be used for determining journal bearing conditions. The AE monitoring is more sensitive than SV and AS monitoring methods for eccentric bore bearing fault.

## References

1. Y Hori, 'Hydrodynamics lubrication', Springer Verlag, Tokyo, Japan, 2006.
2. R Schoen, T G Habetler, F Kamran and R G Bartheld, 'Motor bearing damage detection using stator current monitoring', IEEE Trans. On Industry Application, Vol. 31, No. 6, pp. 1274-9,1995.
3. S Flood, 'Mechanical Reliability-What Realistically can be Achieved', IMechE Mechanical Sealing Technology Seminar, London, UK, 2007.
4. H Ahmadi, K Mollazade, 'Bearing Fault Diagnosis of a Mine Stone Crasher by Vibration Condition Monitoring Technique', Research Journal of Applied Sciences, Engineering and Technology, Volume 1, Issue 3, pp. 112-115, 2009.
5. F K Choy, J Zhou and M J Braun, 'Vibration Monitoring and Damage Quantification of Faulty Ball Bearing', Journal of Tribology, Volume 127, Issue 4, pp. 776-784, October, 2005
6. J Shiroishi, S Liang, Danyluk and T Kurfess, 'Vibration Analysis for Bearing Outer Race Condition Diagnostics', Journal Brazil, Society Mechanical Science, Vol. 21, No. 3, September, 1999 .
7. G DeBotton, B G, Ari, E J Sher, 'Vibration monitoring as a predictive maintenance tool for reciprocating Engine', Proceedings of the Institution of Mechanical Engineer D, Volume 214, Issue 8, pp. 895, SAGE Publications, 2000.
8. S Pandey, B C Nakra, 'Vibration Monitoring of a Rotor System using RMS Acceleration', Journal of Engineering Science and Technology, Volume 3, Issue 4, pp. 2559-2572, 2011.
9. M H Monavar, H Ahmadi, S Mohtasebi and S Hassani,'Vibration Monitoring Techniques for Fault Diagnosis of Electromotor with 1.5kW Power', Journal of Applied Sciences, Volume 8, Issue 7, pp. 1268-1273,2008.
10. S M DeCamillo, M He, C H Cloud, J M Byrne, 'Journal Bearing Vibration and SSV Hash', Proceeding of the Thirty Seventh Turbo machinery Symposium, pp. 11-23, 2008.
11. J Gribble, 'Acoustic analysis for the rest of us', Machinery Lubrication, Noria Publication, No. 839, January, 2006.

12. M Geneses, J Romeu, T Pamies And A Sanchez, 'Aircraft Noise Monitoring with Linear Microphone Arrays', IEEE Aerospace and Electronic Systems Magazine, Volume 25, Issue 1, pp.14-18, 2010.
13. A Jang, F Gu, R M Gennish, P H Jonathan and A Ball, 'Monitoring of Diesel Engine Combustions Based on the Acoustic Source Characterisation of the Exhaust System'. Mechanical Systems and Signal Processing, 22 (6). pp. 1465-1480. ISSN 08883270, 2008.
14. M Dickerhof, A Albers, W Burger and R Sovino, 'Monitoring Lubrication Regimes in Sliding Bearings – Using Acoustic Emission Analysis', Practicing Oil Analysis, May, Noria Publication, 2006.
15. M Abdullah, Al-Ghamd and D A Mba,D, 'Comparative experimental study on the use of acoustic emission and vibration analysis for bearing defect identification and estimation of defect size', Mechanical Systems and Signal Processing, Elsevier, 20, pp. 1537-1571, 2006.
16. K M Holford, R Pullin, S L Evans, M L Eaton, J Hensman and K Worden, 'Acoustic emission for monitoring aircraft structures', Proceeding of the Institution of Mechanical Engineer-G, Volume 223, Issue 5, pp. 525, 2009.
17. N Hamzaoui, C Boisson and C Lesueur, 'Vibro-Acoustic Analysis Identification of defect in rotating machinery, Part II: Experimental Study, Journal of Sound and Vibration, Volume 216, Issue 4, October, pp. 571-583, 1988.
18. J Abdo, 'Investigation of contact stiffness and its relation to friction induced noises and vibration', International Journal Modelling and Simulation, Vol, 26, No. 4, pp. 295-302, 2006.
19. M Zubieta, M J Elejabarrieta and M M B Ali, 'Characterization and modelling of static and dynamic friction in a damper', Mechanism and Machine Theory, No 44, pp 1560-1569, 2009.
20. V P Sergienko and S N Bukharov, 'Vibration and Noise in Brake System of Vehicles', Part 2: Theoretical Investigation Techniques, Journal of Friction and Wear, Vol.30, No.3, pp.216-226, Allerton Press Inc, 2009.
21. A Guran, F Pfeiffer and K Popp, 'Dynamics with Friction, Modelling, Analysis and Experiment', Part II, World Scientific Publishing Co. Pte. Ltd, London.
22. Bonnes, R., McBride, S.,(1991), 'Adhesive and abrasive wear studies using acoustic emission techniques', Wear, Volume 149,Issues 1-2, pp. 41-53, 2001.
23. M Ali and D Mba, 'Observation of Acoustic Emission in A Hydrodynamic Bearing', The 2<sup>nd</sup> International Conference on Technical Inspection and NDT (TINDT 2008), October , Teheran, Iran, 2008
24. Y Fan, F Gu and A Ball, 'Modelling acoustic emission generated by sliding friction', Wear, Elsevier, 2009.
25. F Barron, 'Industrial Noise Control and Acoustic', Marcel Dekker, Inc.,New York, 2001.
26. M Kim, G Jang, C Lee, and D Lim, 'Experimental identification of abnormal noise and vibration in a high speed polygon mirror scanner motor due to mechanical contact of plain journal bearing', Microsystems Technology, 16, pp.3-8, Springer Verlag, 2010 .
27. R Rorrer, and V Juneja, 'Friction-induced vibration and noise generation of instrument panel material pairs', Tribology International, No. 35, pp. 523-531, Elsevier, 2002 .
28. B H Rho, D G Kim and K W Kim, 'Noise analysis of oil lubricated journal bearings', Mechanical Engineering Science, Proceeding Institution Mechanical Engineer, Vol 217, Part C, pp.365-371, 2003