



University of HUDDERSFIELD

University of Huddersfield Repository

Singh, Devendra

Investigating the Effect of Engine Lubricant Viscosity on Engine Friction and Fuel Economy of a Diesel Engine

Original Citation

Singh, Devendra (2011) Investigating the Effect of Engine Lubricant Viscosity on Engine Friction and Fuel Economy of a Diesel Engine. Masters thesis, University of Huddersfield.

This version is available at <http://eprints.hud.ac.uk/id/eprint/14060/>

The University Repository is a digital collection of the research output of the University, available on Open Access. Copyright and Moral Rights for the items on this site are retained by the individual author and/or other copyright owners. Users may access full items free of charge; copies of full text items generally can be reproduced, displayed or performed and given to third parties in any format or medium for personal research or study, educational or not-for-profit purposes without prior permission or charge, provided:

- The authors, title and full bibliographic details is credited in any copy;
- A hyperlink and/or URL is included for the original metadata page; and
- The content is not changed in any way.

For more information, including our policy and submission procedure, please contact the Repository Team at: E.mailbox@hud.ac.uk.

<http://eprints.hud.ac.uk/>

University of Huddersfield, UK

School of Computing and Engineering
(Mechanical Engineering)



Investigating the Effect of Engine Lubricant Viscosity on Engine Friction and Fuel Economy of a Diesel Engine

Submitted by
Devendra Singh

Supervisor:
Prof. John D. Fieldhouse
(Automotive Research Group, SCE, UoH, UK)

Co-Supervisors:
Prof. D.R. Brown
(Department of Chemical and Biological Sciences, UoH, UK)

Sh. A.K. Jain
(Scientist G, Indian Institute of Petroleum, CSIR, Dehradun)

A Dissertation Submitted to SCE in Partial fulfillment of the requirements for the
Degree of Master of Science by Research in Mechanical Engineering
June 2011

ACKNOWLEDGEMENT

The author would like to express his gratitude to Prof. John.D.Fieldhouse, Automotive Engineering Group, School of Computing and Engineering, and Prof D.Rob.Brown, University of Huddersfield, UK for their keen interest, inspiring guidance, helpful suggestion and providing the quintessential environment to conduct this research work. Special mention has to be made of Dr. Fengshou Gu, for all of the technical insight and help provided in analysing the data on numerous occasions during the project work.

The author would also like to thank British Council, UK and DST, India for approving a joint project UKIERI Research award, under which author got an opportunity to undertake this small piece of work. Author is indebted to Dr. M.O.Garg, Director IIP, Dehradun for being the main source of inspiration behind this research work.

My sincere thanks are due to Dr M.R.Tyagi, Head Tribology Division, Dr S.K.Singal, Head Automotive Fuels and Lubes Application Division, Sh A.K.Jain, Scientist G, Sh Nishan Singh, Scientist G and other colleagues of Indian Institute of Petroleum, Dehradun, for their valuable suggestion and continuous encouragement in carrying out this work.

Last but not the least thanks are due to all the team members of the UKIERI Joint project between IIP-CSIR, India and UoH, UK for their kind support and help provided during the project work. Finally, I would like to thank my parents; my wife and other family members for all support provided during the project work and would like to dedicate this dissertation to my son Divyanshu for giving me a very important reason to remain happy.

Devendra Singh

COPYRIGHT STATEMENT

- i. The author of this thesis (including any appendices and/or schedules to this thesis) owns any copyright in it (the “Copyright”) and he has given The University of Huddersfield the right to use such Copyright for any administrative, promotional, educational and/or teaching purposes.
- ii. Copies of this thesis, either in full or in extracts, may be made only in accordance with the regulations of the University Library. Details of these regulations may be obtained from the Librarian. This page must form part of any such copies made.
- iii. The ownership of any patents, designs, trademarks and any and all other intellectual property rights except for the Copyright (the “Intellectual Property Rights”) and any reproductions of copyright works, for example graphs and tables (“Reproductions”), which may be described in this thesis, may not be owned by the author and may be owned by third parties. Such Intellectual Property Rights and Reproductions cannot and must not be made available for use without the prior written permission of the owner(s) of the relevant Intellectual Property Rights and/or Reproductions.

ABSTRACT

Fuel economy is affected, both by fuel and engine lubricant quality. Engine lubricant quality plays a vital role in reduction of fuel consumption by effective reduction of friction between the contact surfaces of engine parts (piston ring assembly, bearings and valve train). Engine components are exposed to various lubrication regimes such as hydrodynamic, elasto-hydrodynamic, boundary and mixed lubrication during engine operation. In each of these regimes, the factors which influence engine friction are different. Hydrodynamic friction is influenced by lubricant rheology, film thickness and sliding speed of interacting surfaces, whereas boundary and elasto-hydrodynamic friction is a function of surface properties like roughness and hardness and the type of friction modifier used in engine lubricant. So the principal factors which influence engine friction power are speed, load, and surface topography of engine components, oil viscosity, oil temperature and type of friction modifiers used.

It is generally accepted that both the piston assembly and bearings are predominantly in the hydrodynamic lubrication regime, whereas the valve train is in the mixed/boundary lubrication regime. Hydrodynamic friction is proportional to sliding velocity of a pair, oil film thickness, operating temperature, lubricant viscosity and many other physical parameters.

To investigate the effect of engine lubricant viscosity on friction characteristics and fuel consumption of a heavy duty and light duty diesel engine, an experimental study was carried out on a 4-cylinder, Direct Injection off-highway, heavy-duty, diesel engine and 4- cylinder indirect injection, light duty diesel engine coupled with the appropriate eddy current dynamometers and instrumented with fuel consumption measurement unit, pressure sensor, angle encoder, speed sensor, temperature indicators, data acquisition system etc, to measure the fuel consumption, power/torque etc. Two engine lubricants were selected for both types of engine in such a way that both lubricants were of same performance category but having different viscosity grade. For DI diesel engine SAE 20W-50 and SAE 10W-30 engine lubricant complying with API CG-4 were chosen, whereas for IDI diesel engine SAE 15W-40 and SAE 5W-30 engine lubricants complying with API CF-4 were selected. It is to be noted that recommended engine oil was taken as baseline lubricant for the friction and fuel consumption study. Test results in terms of friction mean effective pressure (FMEP), friction power, fuel consumption (g/kWh) were analyzed for DI heavy duty diesel engine for both engine lubricants. Whereas test results in terms of fuel

consumption and Fuel Efficiency (%FE) for the light duty IDI diesel engine were analyzed for both engine lubricants.

In order to determine the most dominant factor among the engine operating conditions such as speed, load and engine lubricant viscosity, which affect engine friction power significantly, a full factorial design of experiments (DOE) was formulated to analyze some of the important parameters by which engine friction power influenced significantly. Three factors; speed, load and oil viscosity were chosen as variables with each factor having two levels.

Statistical analysis for determining the dominant factor, affecting the friction power of an engine revealed that the engine speed and speed-load combination are the most significant factors on which engine friction is strongly influenced. An empirical model was developed based on the selected parameters i.e. speed, load and engine lubricant viscosity for predicting the distribution of possible outcomes (friction power) for the Off-highway, DI diesel engine. It may be seen with this investigation that there is consistent reduction in engine friction power at high speed when lower viscosity grade engine oil was used instead of the recommended viscosity grade engine oil. Hence it may be concluded from the experimental engine study that lower viscosity engine lubricant with the same API performance category levels as of OEMs recommended engine lubricant, used for both DI heavy duty and IDI light duty diesel engine, results in reduction in friction power, fuel consumption and yield better fuel efficiency than the recommended engine lubricant.

TABLE OF CONTENT

Abstract	4
Overview of the Thesis	11
1. Introduction and Objectives	13
2. Literature Review	19
3. Engine Friction Basics	22
3.1 Piston ring liner friction	25
3.2 Bearing friction governing equation	28
4. Engine Friction Measurement Technique	31
5. Experimental Details for DI Heavy Duty Diesel Engine	33
5.1 Results and Discussion for DI Engine	36
6. Experimental Details for IDI Light Duty Diesel Engine	45
6.1 Results and Discussion for IDI Engine	47
7. Analysis of Dominant Factor Influencing Friction Power by DOE	50
8. Conclusion and Recommendation	57
9. References	59
10. Annexure I	61
Matlab Programme for cylinder pressure	
11. Annexure II	65
Factorial Fit: FP (kW) versus speed, load and viscosity	
All factors with main effects, first order interaction and second order interaction	
12. Annexure III	66
Factorial Fit: FP (kW) versus speed, load and viscosity	
Significant factors and its interactions	

List of Tables

Table 1. Fully warmed up engine friction power losses in W	20
Table 2. Engine specifications for DI	33
Table 3. Test operating conditions	34
Table 4. Physical characteristics of both engine lubricants	35
Table 5. Pressure sensor specifications	35
Table 6. Mean effective Pressures at different load for engine lubricant SAE 20W-50 at both speeds	37
Table 7. Mean effective Pressures at different load for engine lubricant SAE 10W-30 at both speeds	38
Table 8. Indicated power (IP), Brake power (BP) and Friction power (FP) for both oils under prescribed engine operating conditions	40
Table 9. Percentage reduction of bsfc (g/kWh) of an engine operating at 2000 rpm	44
Table 10. Test engine specification for IDI	45
Table 11. Induction Run Test cycle	47
Table 12. Test results of full load Performance of engine charged with Engine Oil 'C'	47
Table 13. Test results of full load Performance of engine charged with Engine Oil 'D'	48
Table 14. Comparative results of bsfc (g/kWh) for both engine lubricants at different speeds under steady state conditions	48
Table 15. Factors with its levels of experiment	50
Table 16. Physical characteristics of both engine lubricants	50
Table 17. Full Factorial Design of Experiment with Response Variable Friction Power (FP), kW	52
Table 18. Estimated effects coefficients with p-values.	53

List of Figures

Fig 1. Energy Distribution	14
Fig 2. Global production of different types of vehicles	14
Fig 3. Four valves per cylinder	15
Fig 4. V-type Internal Combustion Engine	16
Fig 5. Stribeck curve representing different lubrication regime	17
Fig 6. Distribution of the total mechanical losses of a diesel engine	19
Fig 7. Stribeck Diagram for journal bearing; Coefficient of friction, f versus dimensionless duty parameter, $\mu N/\sigma$	22
Fig 8. Schematic of two surfaces in relative motion under boundary lubrication conditions	23
Fig 9. Schematic of hydrodynamic oil film between liner and piston, assuming liner is moving	26
Fig 10. Critical parts of engine	28
Fig 11. Film geometry of the typical journal bearings	29
Fig 12. Test bench setup	34
Fig 13. Schematic representation of experimental test set-up	34
Fig 14. Graphical representation of variation of mean effective pressures with load for engine lubricant SAE 20W50 at both speed	38
Fig 15. Graphical representation of variation of mean effective pressures with load for engine lubricant SAE 10W-30 at both speed	39
Fig 16. Comparison of Friction mean effective pressure, FMEP vs torque for both engine lubricants	40
Fig 17. Engine friction power at different operating conditions for both oils	41
Fig 18. Comparative Performance characteristics curves for both engine oils	49
Fig 19. Comparative bsfc (g/kWh) of Oil C and Oil D	49
Fig 20. Normal plot of all factors (effects) influencing the response Friction Power	54
Fig 21. Pareto Chart for all factors (effects) influencing the response Friction Power	54

Fig 22. Main Factors (effects) plot speed, load and lubricant viscosity for the response Friction Power	55
Fig 23. Interaction Plot of speed-load, speed-viscosity, load-viscosity for the response Friction Power	55

NOMENCLATURE

Symbol	Description
B	Width of the ring
C	Bearing clearance (R_1-R_2)
$\partial P/\partial x$	Pressure gradient along the width of piston ring
$\partial P/\partial y$	Pressure gradient in circumferential direction of a piston ring
$\partial P/\partial z$	Pressure gradient through film thickness
dh/dx	Film thickness gradient along the ring width
F_n	Normal load
F_t	Force required for tangential motion
f	Coefficient of friction
f_s	Metal-to-metal coefficient of dry friction
f_L	Hydrodynamic coefficient of friction
h	Film thickness
h1	Film thickness at the entrance
h2	Film thickness at the start of cavitation region
hmin	Film thickness corresponding to the maximum pressure
M_1, M_2	Fuel consumptions at steady state
N	rotational speed of the shaft (rpm)
P1 and P2	Pressure at entrance and exit of ring face
q_x	Flow rate per unit circumferential length of a ring
R_1 and R_2	Radius of bush and shaft
U	Velocity of liner
V	Velocity of a ring in circumferential direction
w_h, w_o	Velocity of top and bottom layer
τ_m	shear strength of the material

μ, η	Dynamic viscosity of the lubricant
σ	loading force per unit area
σ_m	yield stress of the material
Vd	Displacement volume
ω	angular speed (rad/s)

ABBREVIATIONS

BDC	Bottom Dead Center of an engine cylinder
BMEP	Brake Mean Effective Pressure
BP	Brake Power
bsfc	Brake Specific fuel consumption
CI	Compression Ignition
DOE	Design of Experiment
DI	Direct Injection engine
FE	Fuel efficiency
FMEP	Friction Mean Effective Pressure
FP	Friction Power
IP	Indicated Power
IDI	Indirect Injection engine
IMEP	Indicated Mean Effective Pressure
rpm	revolutions per minute
SAE	Society of Automotive Engineers

OVERVIEW OF THE THESIS

This thesis has been written with a perspective to investigate the effect of engine lubricant viscosity on engine friction and fuel consumption of a diesel engine. The engine components resulting in the majority of engine friction are; piston ring assembly, valve train system, bearing system and engine powered auxiliaries (such as the water pump, oil pump, fuel pump etc.). Piston ring assembly and bearings are predominantly operating in the hydrodynamic lubrication regime and contribute significantly towards engine friction losses, whereas the valve train system operates in the mixed/boundary lubrication regime, also plays vital role towards engine friction. Hydrodynamic friction is influenced by lubricant viscosity, sliding velocity and oil film thickness whereas boundary/mixed friction is dependent on the surface properties such as roughness, hardness, elasticity, plasticity, shearing strength, of sliding pair factor as well as by lubricant properties like friction modifiers.

The main focus of this thesis is to understand and investigate the effect of engine lubricant viscosity on engine friction and fuel consumption of a diesel engine, theoretically and experimentally. It has also been attempted to determine the most dominating factor among engine operating condition; speed, load and viscosity, which affect engine friction significantly. This thesis is arranged in four major sections. The first section (Chapter 1 to 3) provides an introduction, aims or objectives and literature review related to scope of research work, where the need of this study is highlighted and clearly defines the objectives of the proposed research work undertaken.

The second section (4 and 5) focuses on the basics of friction using a stribeck curve to describe the different lubrication regimes such as boundary, mixed and hydrodynamic. Further, hydrodynamic friction for engine bearings and piston ring assembly is being derived theoretically using Reynolds equations. This section also highlights some of the standard measurement technique known, for engine friction measurements.

Third section (Chapter 6 and 7) is devoted to the experimental studies for determining the engine friction and fuel consumption of a direct injection diesel engine and fuel consumption for indirect injection diesel engine. It describes the details of the experimental test set up for engine friction studies, test procedure and test operating conditions, test cycle used for determining

IMEP which in-turn is used for calculating FMEP and friction power of an engine. Test results in terms of Friction mean effective pressure, friction power and brake specific fuel consumption are also discussed for different viscosity grade engine lubricants.

Fourth and the last section (8 and 9) of this thesis focuses on the identification of the dominant factor among; engine operating conditions (speed and load) and viscosity of lubricant, which influences friction power significantly using a full factorial method of Design of experiment approach. In this section empirical relation is also developed for analyzing the significant factor affecting engine friction. This section also provides some concluding remarks and recommendation for future studies. Chapter 10 is the reference /Bibliography section which describes the research paper referred while writing this thesis. Finally Annexure I provide the matlab programme used for determining the IMEP through the pressure sensor, angle encoder and data acquisition system installed with the engine. Annexure II, III gives the brief description of factorial fit results used in analysis of the dominant factor.

Chapter 1

INTRODUCTION AND OBJECTIVES

Economy, Efficiency, Effectiveness and Ecology form the four significant pillars for sustainable growth of any nation. Worldwide, crude oil prices were very unstable during 2008-09, peaking up to \$145 per barrel in July 2008 before coming down at the end of year 2009, but again the price is reaching to \$100 per barrel during year 2010-2011. Hence crude oil price has become a matter of great concern for everyone.

Combined with the demands of crude oil the drive towards low carbon emissions, and the recognition that current fossil fuel supplies are predicted to last possibly only 40 years, has focused the attention of the automotive industry to towards alternative fuels supplies and improved engine efficiency.

Figure 1 shows the general energy distribution of energy where it is seen that road transportation demands almost 16% of the available fuel sources. This is distributed between commercial vehicles and domestic vehicles as indicated in figure 2. It can be seen that in general terms the industry is producing some 90 million units per year into a global market that already supports some one billion (10^9) units. Based on fundamental and conservative figures of 10,000 miles/year per unit this gives 10×10^{12} miles per year. If a consumption of 7 miles/litre is assumed then this represents a fuel demand of 1.4×10^{12} litres per year. Clearly with such demands, which continues to increase, then there is a need to seek a means to reduce fuel consumption by improved engine efficiencies - and improved lubrication is one way forward.

World lubricant demand will increase 1.6 percent per year to 40.5 million metric tons in 2012 [1] and India is the third largest consumer of lubricants in Asia, India's overall lubricants market is expected to grow 3.7 percent per year to reach 2.2 million metric tons by 2014 [2]. India spends substantial amount of nation's revenue in importing approximately 70% of total crude oil, required for energy. Conservation of fossil fuel is paramount to engineers, scientist and researchers in the wake of rapidly depleting petroleum resources. Therefore, utilizing these petroleum resources judiciously, efficiently, effectively, environment friendly and sustainably is the need of an hour.

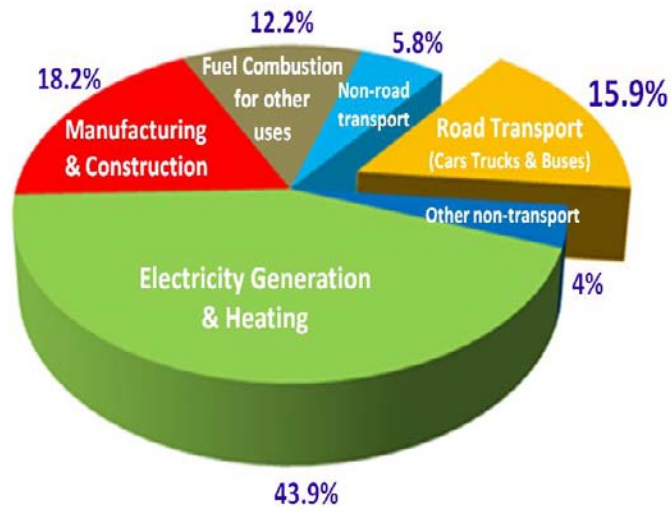

Figure 1. Energy Distribution

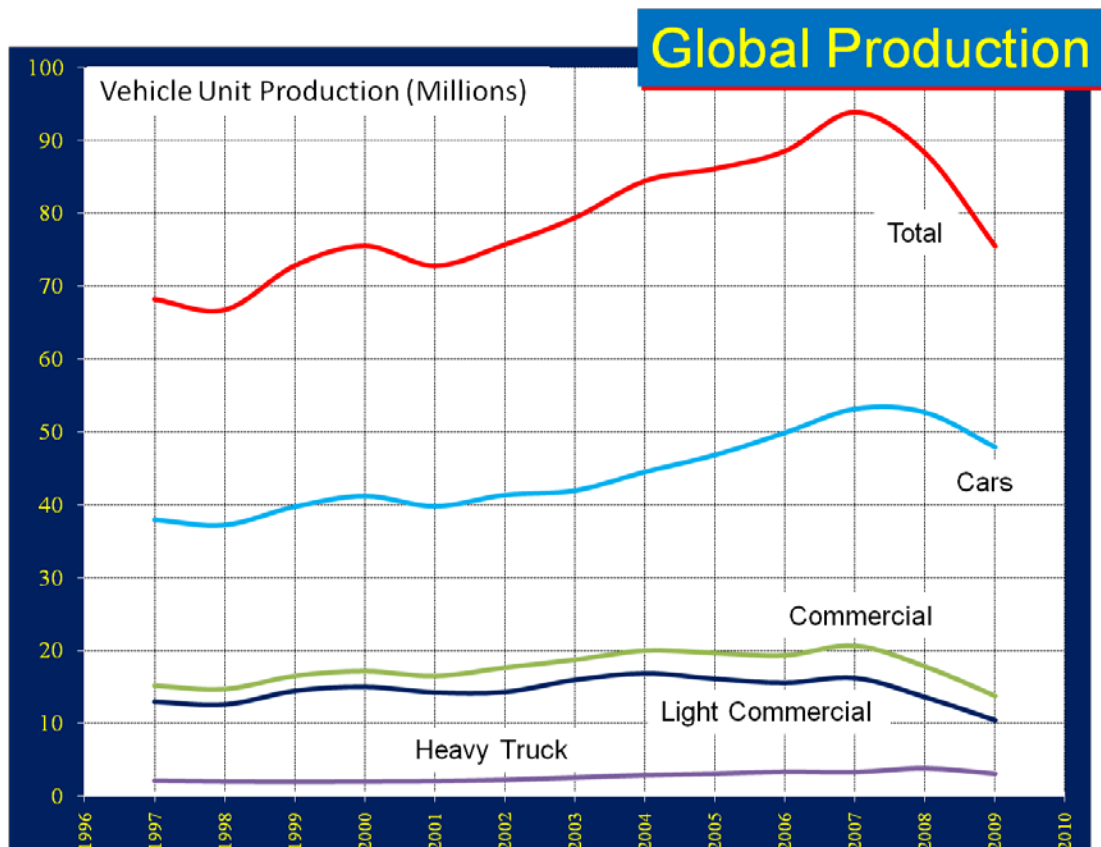

Figure 2. Global production of different types of vehicles

<http://oica.net/wp-content/themes/default/scripts/view-diagram-larger.php?wp-content/uploads/co2.bmp>

It is now of major concern that exhaust emissions are seen as a global threat so improving the efficiency of the power-train is a priority. Regulations of exhaust emissions and fuel economy are the main driving force behind the development of advanced IC engines. Automotive industries are putting significant amount of efforts in designing the fuel efficient vehicle by adopting latest engine technology in order to conserve the fuel.

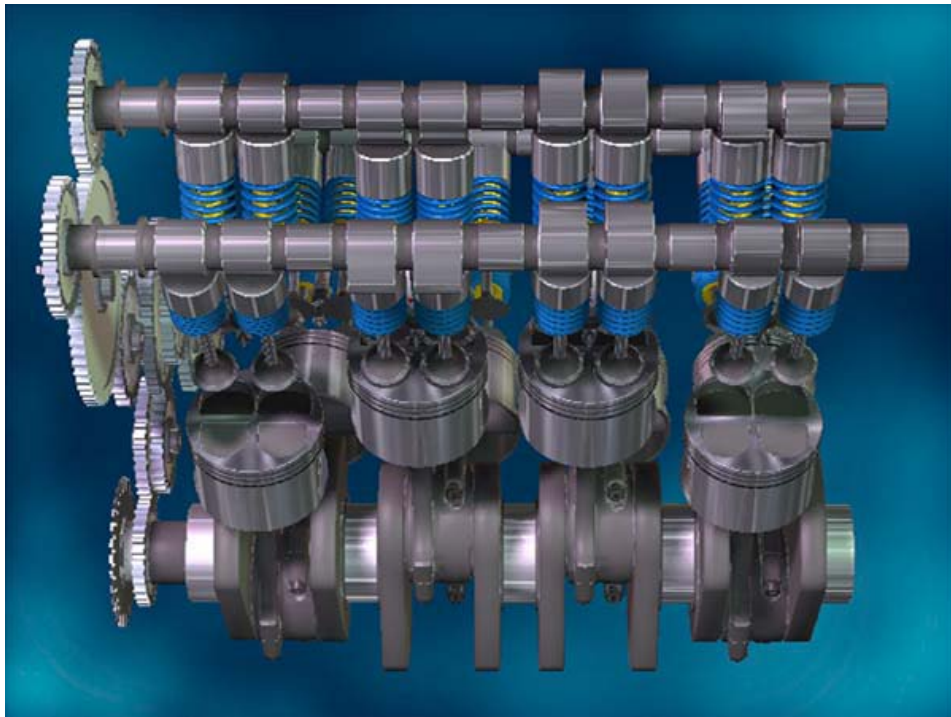

Figure 3. Four valves per cylinder

On the engineering side, manufacturers of Passenger cars have introduced 4-valves per cylinder (figure 3), roller follower valve train systems, lighter aluminum engines, smaller engine bearings and gasoline direct injection engines and catalytic converters. Similarly, there have been many advances in the design of heavy duty diesel engines over recent years including the introduction of high pressure fuel injection systems, the increasing use of 4-valves/cylinder and the improved electronic management systems. Fuel economy of new vehicles could be improved through dedicated and focused design improvements but for existing vehicles that proves to be difficult. It is envisaged that the best way forward for both new and old vehicles is to reduce existing friction losses inside an engine – improve the lubrication of the moving elements.

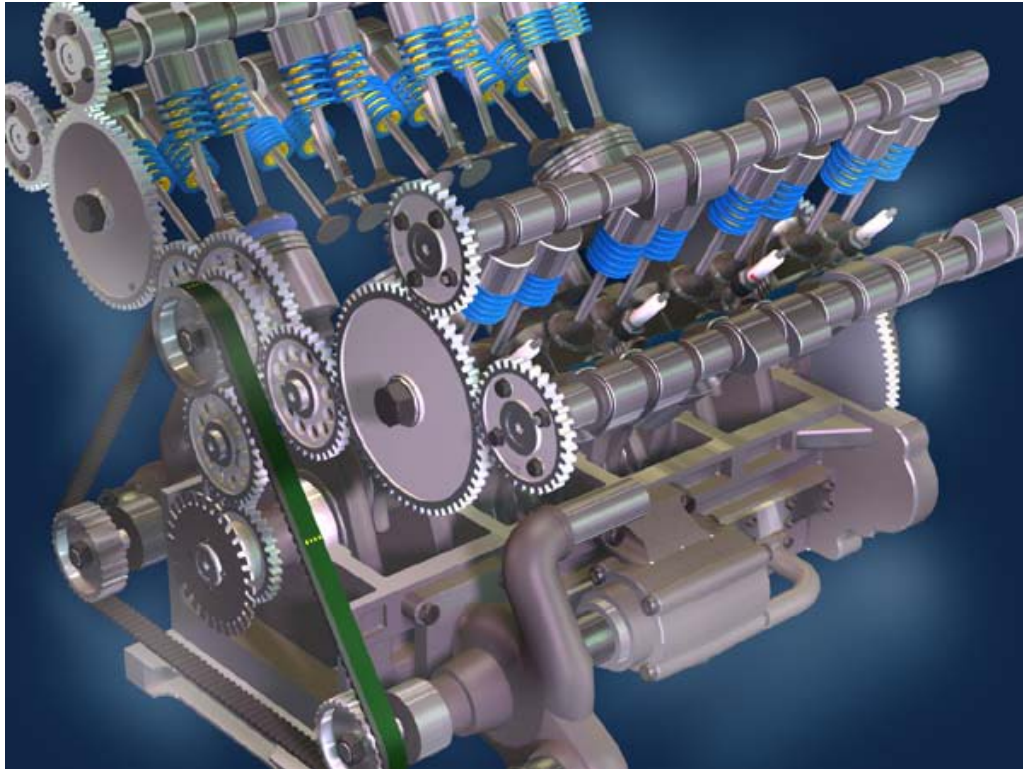

Figure 4. V-type Internal Combustion Engine

Automotive sector consumes a major portion of the petroleum products and in India only its consumption (by automotive sector) is around 60%. Historical studies indicate 10 to 15 % of petroleum fuels used for on-road transportation is consumed by engine and driveline friction - more than the energy delivered to the wheels [3]. Automotive engine lubricant quality also plays a very important role in improving the fuel economy and reducing the vehicle exhaust emissions. Fuel efficient engine lubricant reduces the friction between the contact surfaces of critical engine parts, which leads to reduction of fuel energy utilized for overcoming the friction, hence conserving the fuel. In a day, we consume so many millions barrels of oil and an improvement of 1 to 2% in fuel consumption through engine oil technology could lead to significant cost savings and major reduction in exhaust emissions. The need for fuel efficient automotive lubricant for the next generation vehicle is felt due to rise in the crude prices and the stringent emissions norm viz; Euro V and beyond, that will be coming up in subsequent years. It is interesting to note that significant savings can be achieved by improving the vehicle mileage by reducing the engine friction through engine lubricant technology. Therefore engine lubricant becomes one of the important design parameters.

The critical engine components resulting in the majority of engine friction are; piston ring/liner assembly, bearing system, valve train system, and engine powered auxiliaries (such as the water pump, oil pump and fuel pump). It is generally accepted that both the piston assembly and bearings are operating predominantly in the hydrodynamic lubrication regime, whereas the valve train system is operating in the mixed/boundary lubrication regime.

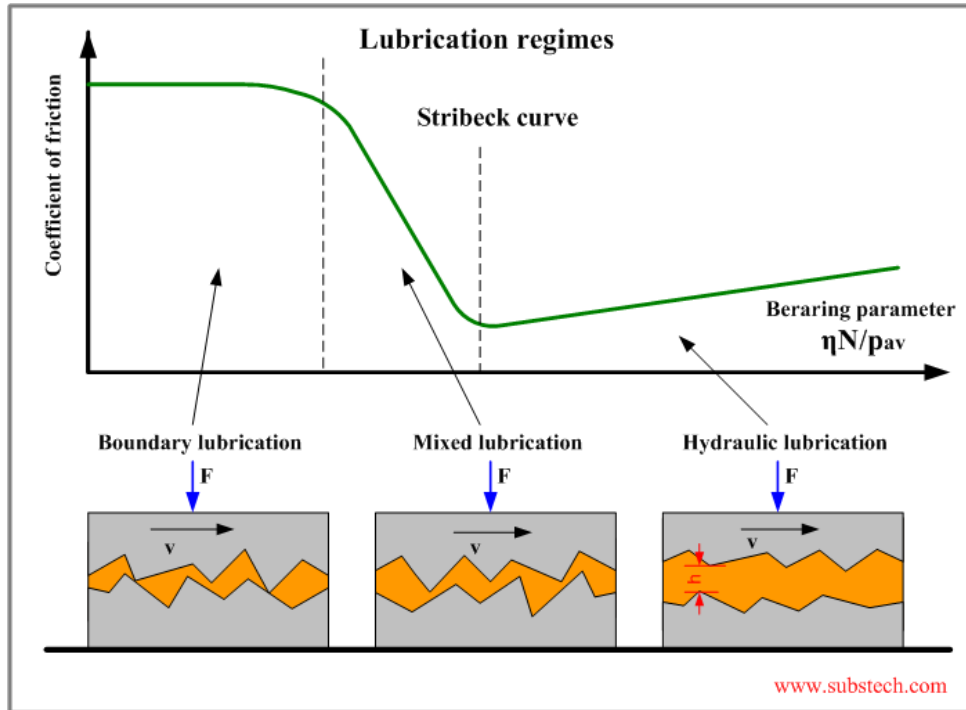

Figure 5. Stribeck curve representing different lubrication regime

The friction due to hydrodynamic lubrication regime (piston ring/liner assembly and bearing system) is thought to dominate engine friction. Hence the approach of the present study is to reduce this hydrodynamic friction somehow, which in-turn reduces the fuel consumption of an engine. It is a known fact that hydrodynamic friction is related to the viscosity of engine oil and it has been shown that this friction can be reduced by using low viscosity grade engine lubricant [4]. These friction behaviour of contacting surfaces can be explained with help of stribeck curve consist of all lubrication regimes from boundary to mixed, elasto-hydrodynamic to hydrodynamic in the following sections. It may be assumed that two-thirds of the friction losses in an engine are estimated to occur during the hydrodynamic lubrication of components (piston ring/liner assembly, bearings) and one-third during boundary lubrication or mixed lubrication components. The new energy-conserving engine oils are designed to reduce friction losses from

both types of lubrication by tailoring the viscosity characteristics of the base oil and the chemistry of the friction-modifying additives.

Aims and Objectives

The focus of this research work is to investigate the effect of engine lubricant viscosity on engine friction characteristics and fuel consumption of a diesel engine theoretically and experimentally. Another important objective is to identify the dominant factor among speed, load and lubricant viscosity, which affect engine friction power significantly through a DOE approach. Engine friction study has been a topic of research for many years. Some of the conventional methods like Morse test, PV diagram, Willans lines method and motoring test for measuring friction of an engine are described in the literature [5]. It is widely accepted that PV diagram method yield more accurate results about engine friction. Engine friction was investigated in terms of friction mean effective pressure (FMEP) and friction power of a firing engine, at different engine operating conditions with special emphasis on the particular condition of high speed, low load under controlled conditions to simulate hydrodynamic lubrication conditions. In principle, if the BMEP (Brake Mean Effective Pressure) could be held exactly constant, the difference in FMEP (Friction Mean Effective Pressure) between two lubricants of different viscosity could be determined by comparing the net IMEP (Indicated Mean Effective Pressure) of each lubricant.

Chapter 2

LITERATURE REVIEW

The critical engine components resulting in the majority of engine friction are; piston ring/liner assembly, bearing system, valve train system, and engine powered auxiliaries (such as the water pump, oil pump and fuel pump). To optimize the effects of lubrication many researchers have studied the frictional contribution of individual engine components both theoretically and experimentally through the use of fired and motored laboratory engine tests. Typical distribution of the mechanical losses in a diesel engine is given in the figure 6. It can be deciphered from the pie chart that piston ring assembly and bearings contributes to approximately 70% of the total mechanical losses. Two-thirds of the friction losses in an engine are estimated to occur during the hydrodynamic lubrication of components (piston ring/liner assembly, bearings) and one-third during boundary lubrication or mixed lubrication components.

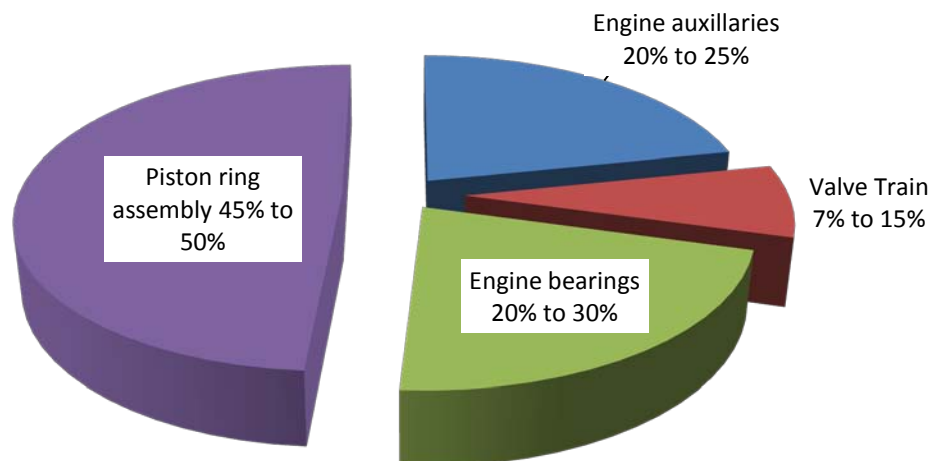

Figure 6. Distribution of the total mechanical losses of a diesel engine [6, 7].

It is a well accepted fact that the piston ring assembly and engine bearings operate predominantly in the hydrodynamic lubrication regime during engine operation. Hydrodynamic lubrication friction is related to the lubricant viscosity. Effect of engine oil viscosity on engine friction and fuel consumption was studied by many researchers. Radimko Gligorijevic et.al. [8] Describes the effect of lubricants of different viscosity grades on the fully warmed up engine friction power

loss (W) - which includes piston ring assembly (P), Valve train (V) and bearing (B). Table 1 shows that total friction power losses are low for the less viscosity grade oil and the power loss through piston ring assembly reduces significantly when lower viscosity grade lubricants was used.

Table 1: Fully warmed up engine friction power losses in W

SAE Grade	10 W 30	15 W 40	20 W 50
Total Losses (W)	1455	1513	1577
P (W)	528 (36%)	639 (42%)	807 (52%)
V (W)	371 (26%)	287 (19%)	140 (9%)
B (W)	555 (38%)	587 (39%)	630 (40%)

Taylor [9] has reported that the friction losses in the piston assembly vary as $\sqrt{\eta\omega}$, where η is the lubricant dynamic viscosity (mPa.s) (calculated at a temperature representative of the piston assembly) and ω is the angular speed (rad/s) of the engine.

For journal bearings, under light loaded conditions, petroff equation [10] suggested that the friction power loss would vary linearly with lubricant viscosity.

$$F = 2\pi\eta\omega^2LR^3 / c$$

Where F is the friction power loss (watts), η is the lubricant dynamic viscosity (mPa.s) appropriate to the bearing, ω is the engine's angular speed (rad/s), L is the bearing width (m), R is the bearing radius (m) and c is the bearing radial clearance (m). For a heavily loaded bearing, Taylor [11] has shown that the friction power loss would vary as $\eta^{0.75}$. Effects of engine oil viscosity on fuel consumption were studied by Taylor and it has been reported that low viscosity oil results in low fuel consumption [12].

Piston rings act as sealing between the liner and the piston by making thin oil film during their operation. Furuhamma [13] incorporated, for the first time the squeeze film effect in the Reynolds equation for analyzing hydrodynamic lubrication for piston ring/liner assembly under fully flooded inlet conditions. Wakuri et al. [14] also analyzed the piston ring assembly by considering the cavitation effect and a squeeze film in the Reynolds equation. However in reality, ring packs do operate under starved condition for some time during its operation. Starved ring lubrication was also studied by many researchers [15, 16] with different boundary conditions. There is a vast literature available regarding piston ring lubrication. Some of the recent works of Mufti et.al [17,

18] on predicting piston ring assembly friction loss in firing engine using the indicated mean effective pressure (IMEP) method and validating the model by experimental study is remarkable. Mufti et.al [19] also investigated the influence of engine operating conditions and engine lubricant rheology on the distribution of power loss at engine component level. The study was carried out under realistic fired conditions using a single cylinder gasoline engine. A similar study for assessing the effect of engine lubricant rheology on piston skirt friction was undertaken by A. Kellaci et. al. [20] by developing a piston skirt lubrication model based on a modified Reynolds equation. The results of tribological characteristics such as the movement of the piston, the minimum film thickness, the frictional force and friction power loss were studied in relation to the oil viscosity. It was concluded that oil viscosity directly affects friction in the hydrodynamic regime. The best design involves obtaining a system that operates principally in a hydrodynamic lubrication regime using low viscosity oil.

The focus of this study is to understand friction characteristics of these engine components operating in hydrodynamic lubrication regime theoretically and also by experimental studies. The effect of engine lubricant viscosity on hydrodynamic friction has been investigated in terms of friction mean effective pressure (FMEP) of a firing, off-highway, heavy-duty, Direct Injection (DI), diesel engine, at different engine operating conditions with special emphasis on the particular condition of high speed, low load under controlled conditions where it can be assumed the these engine parts are operating in hydrodynamic lubrication regime. FMEP was evaluated by measuring the in-cylinder pressure and calculating IMEP from it. Also, effect of lubricant viscosity on fuel consumption of Indirect Diesel Injection (IDI), on-road, light-duty, diesel engine was investigated through engine dynamometer study under steady state condition. This study (both for DI and IDI diesel engine) would help in developing new energy-conserving engine lubricants for diesel engines, designed to reduce friction losses from both types of lubrication (boundary/mixed and hydrodynamic) by tailoring the viscosity characteristics of the base oil and broaden the scope of modifying the chemistry of the friction modifiers additives of the engine lubricants.

Chapter 3

ENGINE FRICTION BASICS

In order to maximize the fuel economy of an engine lubricant one must first understand the source of the friction. Engine friction and friction in general, can roughly be compartmentalized into two groups: coulomb friction (dry friction) which occurs when asperities come into contact between two surfaces moving relative to each other and fluid friction which develops between adjacent layers of fluid moving at different velocities. The actual degree of friction in engine components can seldom be put into either of these categories, and instead lies somewhere between these two extremes. The different regimes of lubricated friction can be illustrated by means of Stribeck curve shown in figure 7, where the coefficient of friction (f) for a journal bearing is plotted against a dimensionless duty parameter ($\mu N/\sigma$), where μ is the dynamic viscosity of the lubricant, N is the rotational speed of the shaft and σ is the loading force per unit area.

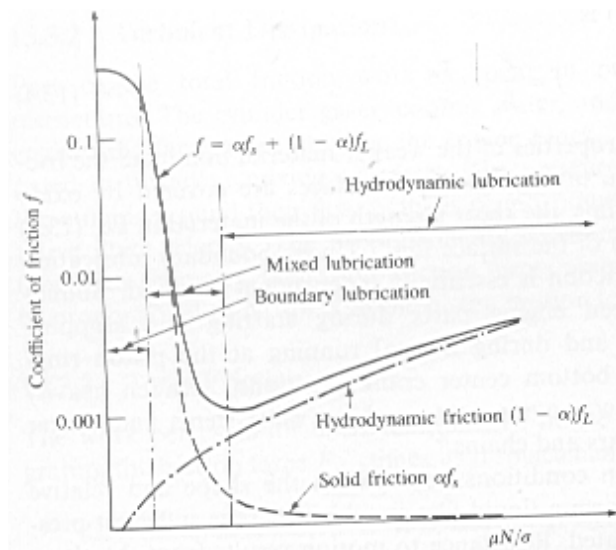

Figure 7. Stribeck curve for journal bearing, Coefficient of friction, f versus dimensionless duty parameter, $\mu N/\sigma$ [5]

The coefficient of friction can be expressed as

$$\mathbf{f} = \alpha \mathbf{f}_s + (1 - \alpha) \mathbf{f}_L$$

where, \mathbf{f}_s is the metal-to-metal coefficient of dry friction

\mathbf{f}_L is the hydrodynamic coefficient of friction

α is the metal-to-metal contact constant varying between 0 and 1.

As $\alpha \rightarrow 1$, $f \rightarrow f_s$ and the friction is called boundary, i.e. closed to solid friction. The lubricating film is reduced to one or a few molecular layer and cannot prevent metal-to-metal contact between surface asperities.

As $\alpha \rightarrow 0$, $f \rightarrow f_L$ and the friction is called hydrodynamic or viscous film. The lubricant film thickness is sufficient to separate the surfaces in relative motion. In between these regimes, there is a mixed or partial lubrication regime where the transition from boundary to hydrodynamic lubrication occurs. While the figure 7 applies to journal bearings, this discussion holds for any pair of engine parts in relative motion with lubricant in between.

Under boundary lubrication conditions, the friction between two surfaces in relative motion is determined by surface properties as well as by lubricant properties. The important surface properties are roughness, hardness, elasticity, plasticity, shearing strength, thermal conductivity and wettability with respect to the lubricant. Figure 8 shows two surfaces under boundary lubrication conditions. Due to the surface asperities, the real contact area is much less than the apparent contact area. The real contact area A_r is equal to the normal load F_n divided by the yield stress of the material σ_m ;

$$A_r = F_n / \sigma_m$$

The force required to cause tangential motion (F_t) is the product of the real contact area and the shear strength of the material τ_m ;

$$F_t = A_r * \tau_m$$

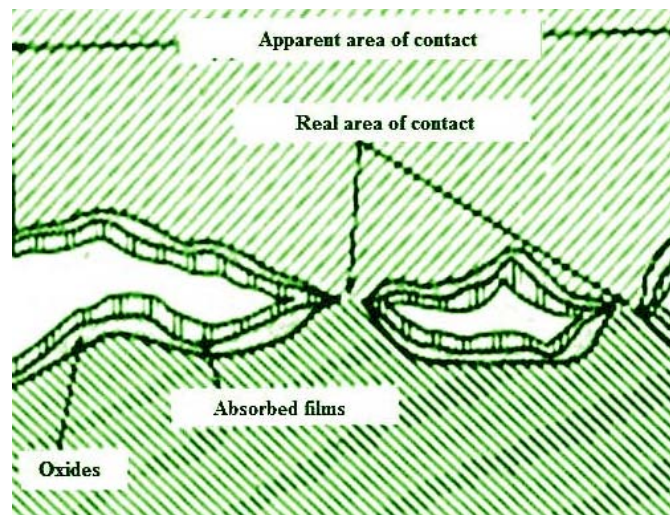

Figure 8. Schematic of two surfaces in relative motion under boundary lubrication conditions [5]

Thus the coefficient of friction f is

$$f = (F_t / F_n) = (\tau_m / \sigma_m)$$

For dissimilar materials, the properties of the weaker material dominate the friction behavior. Under boundary lubrication conditions, the coefficient of friction is essentially independent of speed. Boundary lubrication occurs between engine parts during starting and stopping (bearings, piston and rings) and during normal running at piston TDC and BDC, slow moving parts such as valve stems and rocker arms and crankshaft timing gears.

Hydrodynamic lubrication conditions occur when the shape and relative motion of the sliding surfaces form a liquid film in which there is sufficient pressure to keep the surfaces separated. Resistance to motion results from the shear forces within the liquid film and not from the interaction between surface irregularities, as was the case under boundary lubrication. The shear stress τ in a liquid film between two surfaces in relative motion is given by

$$\tau = \mu (dv/dy)$$

Where, μ is the fluid viscosity and (dv/dy) the velocity gradient across the film. Hence, the friction coefficient (shear stress/normal load stress) in this regime will be proportional to viscosity \times speed \div loading; i.e., a straight line on the stribeck diagram. Full hydrodynamic lubrication or viscous friction is independent of the material or roughness of the parts and only property of lubricant involved is its viscosity. Hydrodynamic lubrication is present between two converging surfaces, moving at relatively high speed in relation to each other and withstanding a limited loaded, each time an oil film can formed. This type of lubrication is encounter in engine bearings, between piston skirt and cylinder liner and between piston rings and liner for high sliding velocities in mid stroke region.

In this study the effect of lubricant viscosity on engine friction and fuel consumption of an engine was studied. The focus of this study is to understand engine friction characteristics operating in hydrodynamic lubrication regime theoretically and also by experimental investigation.

3.1 PISTON RING/LINER FRICTION

It is assumed that compression ring operates in hydrodynamic regime during most of its operating time. Hence the governing equation for piston ring/liner could be Reynolds equation. Now for analyzing the pressure distribution, load capacity, friction force, coefficient of friction etc of piston ring assembly it is necessary to define some important parameters like profile of the ring face, viscosity of oil that keeps piston ring and liner separated during operation, speed of the ring etc. Full Reynolds equation [12] in three dimensional forms for any bearing is given below, here $\partial P/\partial z = 0$, assuming pressure constant throughout the film

$$\frac{\partial}{\partial x}(h^3 \frac{\partial P}{\partial x}) + \frac{\partial}{\partial y}(h^3 \frac{\partial P}{\partial y}) = 6\eta (Udh/dx + Vdh/dy) + 12 \eta (w_h - w_o) \quad (1)$$

Simplifying this equation for piston ring, by assuming an infinitely long bearing, very small width as compared to the circumferential length, pressure gradient in circumferential direction can be neglected i.e $\partial P/\partial y=0$. And also velocity in y direction is assumed to be zero i.e $V=0$ and assuming liner is moving with velocity (U) and ring is stationary, 'h' is film thickness, 'η' is dynamic viscosity of lubricant and w_h , w_o are velocity of top and bottom layer moving up. Considering the squeeze at TDC and BDC i.e replacing $(w_h - w_o)$ by dh/dt , assuming the contacting surfaces are impermeable, Reynolds equation can be written as follows;

$$\frac{\partial}{\partial x}(h^3 \frac{\partial P}{\partial x}) = 6\eta(Udh/dx) + 12\eta dh/dt \quad (2)$$

Ring face profile assumed to be parabolic. In actual operating conditions, hydrodynamic film pressure is generated only in converging region and there is pressure drop in the diverging region results in cavitations. Following conditions may be applied to solve the problem of negative pressure;

- Full sommerfeld condition shows that there is large negative pressure in the diverging region almost equivalent to the peak pressure in the converging zone. This condition can't be applied to the real fluids as total load capacity would be zero due to opposing positive and negative pressure.
- Half sommerfeld condition assumes that pressure in the diverging region to be zero. A shortcoming of this condition is that it violates the flow continuity equation.
- Reynolds boundary condition, $P=dP/dx=0$, may be applied to find the exact location of it in x direction in diverging region.

Hydrodynamic film along the width of the ring face divided into three regions first is hydrodynamic film in converging region where pressure reaches to maximum level, second is cavitation region where pressure assumes to be at atmospheric pressure and finally the third region is reformation of film above atmospheric pressure. These three zones are also represented by Mufti et.al [7].

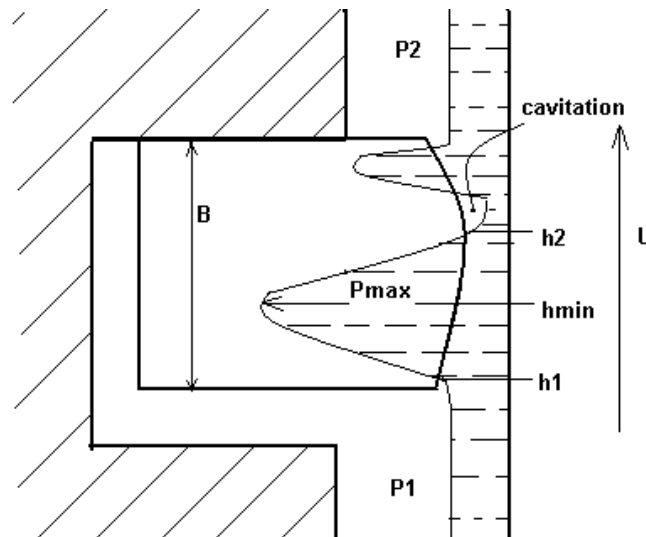

Figure 9. Schematic of hydrodynamic oil film between liner and piston, assuming liner is moving

In figure 9, h_1 is the film thickness at the entrance, h_{min} is the film thickness corresponding to the maximum pressure, h_2 is the film thickness at the start of cavitation region and B is the width of the ring, U is the velocity of the liner in x direction. P_1 and P_2 are the pressure at entrance and exit of ring face.

Hydrodynamic pressure distribution of oil film along x direction in the first region can be calculated by integrating equation (2).

$$dP_1/dx = 6\eta U/h^2 + 12\eta x/h^3(dh/dt) + C_1/h^3 \quad (3)$$

Hydrodynamic pressure distribution in the second region would be zero. And for the third region, during reformation of film, it can be represented by the continuity flow equation, assuming that the exit pressure of third region be P_2 . Flow rate per unit circumferential length of the ring at the start of cavitation boundary would be [12];

3.2 JOURNAL BEARING FRICTION

Main and big end bearing are very vital component of engine and considered to be operating entirely in the hydrodynamic regime. Basic aspects of journal bearing analysis is analyze bearing load capacity, pressure distribution, friction and lubricant flow rate as a function of load, speed and any other controlling parameters. In this study only friction behavior of journal bearing as function of speed and viscosity would be presented. For analysis, first the film geometry of bearing needs to be defined as shown in figure 11 and then applying Reynolds equation to it, will yield pressure, friction, etc. ‘e’ is the eccentricity distance between O_B and O_s , ‘C’ is clearance ($R_1 - R_2$), R_1 and R_2 radius of bush and shaft, ‘h’ is film thickness.

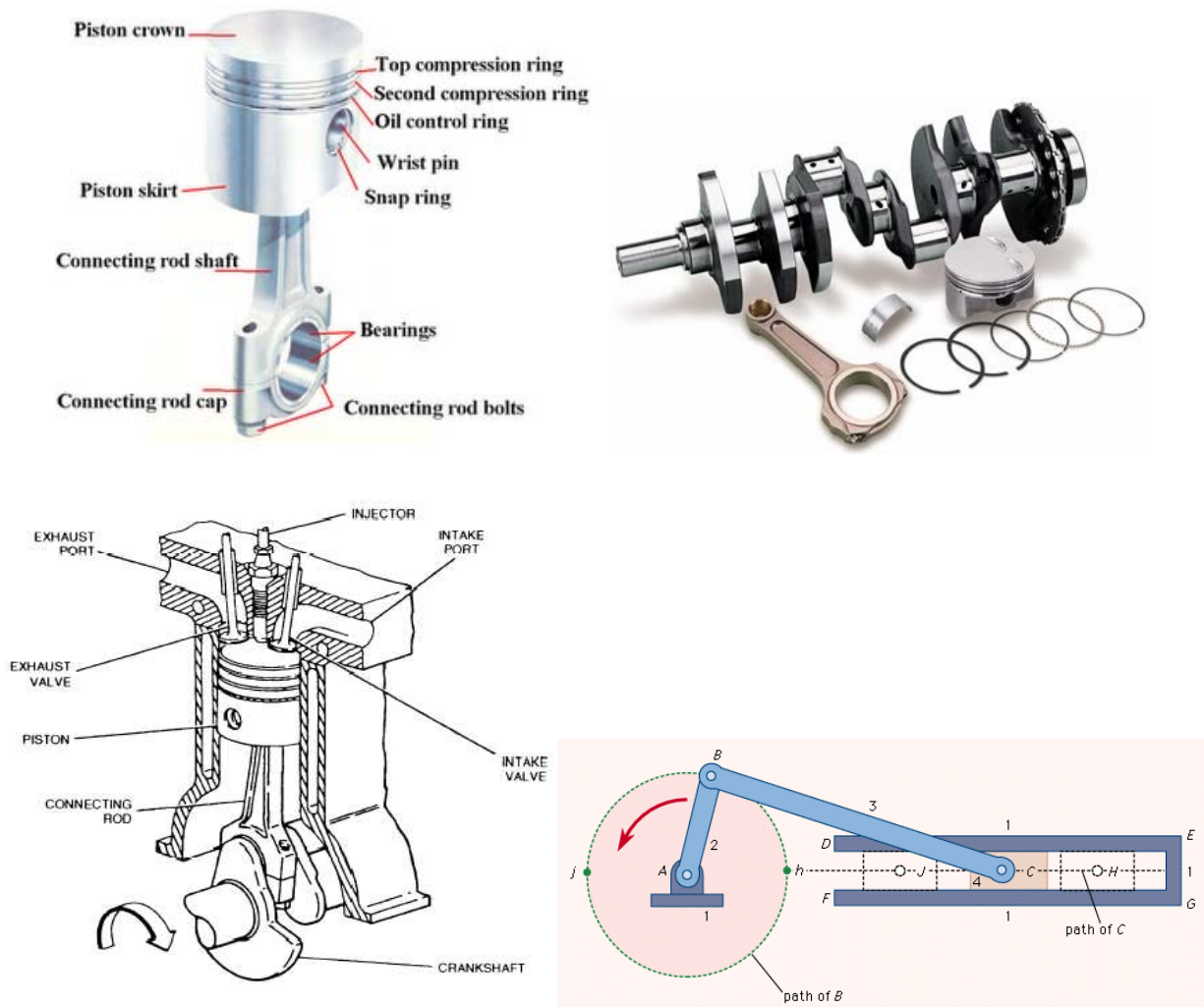

Figure 10. Critical parts of engine

FILM GEOMETRY

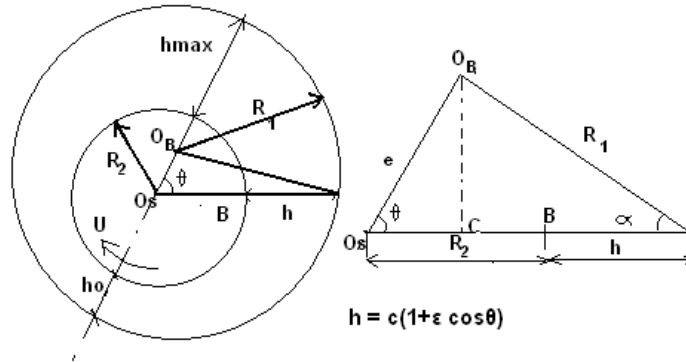

Figure 11. Film geometry of the typical journal bearings

Bearings of the heavy duty engine can be assumed to be the journal bearings with narrow bearings approximations which assume the axial length of the bush to be less than the shaft diameter. Pressure gradient along the 'y' direction is much larger than the x direction pressure gradient (circumferential), i.e. $\partial P/\partial Y \gg \partial P/\partial X$ as length of bush (L) is less than circumference of shaft, i.e. $L \ll B$, so Reynolds equation may be represented as follows;

$$\frac{\partial}{\partial y}(h^3 \frac{\partial P}{\partial y}) = 6\eta(Udh/dx) \quad (11)$$

Since $h \neq f(y)$ then it can be simplified as,

$$d^2P/dy^2 = 6U\eta/h^3(dh/dx)$$

Integrating once, yield Pressure gradient in y direction, integrating once again will give pressure distribution.

$$dP/dy = 6U\eta y/h^3(dh/dx) + C_1 \quad (12)$$

$$P = 6U\eta y^2/2h^3(dh/dx) + C_1 y + C_2$$

Now applying the boundary condition, $P=0$ at $y = \pm L/2$ i.e at the edge of bearing and $dP/dy = 0$ at $y=0$ i.e at the center plane of bearing where pressure is maximum, we can solve constants C_1 and C_2 . So the pressure distribution in narrow bearing is given by

$$P = 3U\eta/h^3(dh/dx)\{y^2 - L^2/4\} \quad (13)$$

Friction force can be calculated by integrating the shear stress over the bearing area. But in case of journal bearing bottom surface, the bush is stationary whereas top surface, the shaft is moving, i.e $U_1=U$ and $U_2=0$

$$F = \int_0^L \int_0^B \eta \left(\frac{du}{dz} \right) dx dy \quad (14)$$

Friction force on the moving surface i.e shaft is given by

$$F = \int_0^B (U \eta L / h) dx$$

Where $h=c(1+\epsilon \cos\theta)$ and $dx=Rd\theta$, $\epsilon=e/c$ is eccentricity ratio and $c=R_1-R_2$ is radial clearance, putting it in the above equation and integrating gives Friction force on shaft.

$$F = (2\pi \eta U L R / c) (1 / (1 - \epsilon^2)^{0.5}) \quad (15)$$

Friction force is directly related to the shaft speed and viscosity of engine lubricant in the bearings, so friction may be reduced by using a low viscosity grade engine lubricant.

Chapter 4

ENGINE FRICTION MEASUREMENT METHODS

Common friction measurement methods are described very briefly as follows;

Measurement of FMEP from IMEP

The gross indicated mean effective pressure is obtained from $\int p \, dv$ over compression and expansion strokes for a four stroke engine and over the whole cycle for a two-stroke engine. This requires accurate and in-phase pressure and volume data. Accurate pressure versus crank angle data must be obtained from each cylinder with a pressure transducer and crank angle indicator. Volume versus crank angle values can be calculated. Both $imep_g$ and p_{mep} are obtained from the P-V data. By subtracting the brake mean effective pressure, the combined rubbing friction plus auxiliary requirements are obtained.

Direct Motoring Test

Direct motoring of an engine, under condition as close as possible to the firing, is another method used for estimating friction losses. Engine temperatures should be maintained as close to normal operating temperature as possible. This can be done either by heating the water and oil flows by conducting a “grab” motoring test where the engine is switched rapidly from firing to motored operation. The power required to motor the engine includes the pumping power. “Motoring” tests on a progressively disassembled engine can be used to identify the contribution that each major component of the engine makes to the total friction losses.

Willans Line

An approximate equivalent of the direct motoring test for the diesel engines is the willans line method. A plot of fuel consumption versus brake output obtained from engine tests at fixed speed is extrapolated back to zero fuel consumption. Generally, the plot has a slight curve, making accurate extrapolation difficult.

Morse Test

In the morse test, individual cylinders in a multicylinder engine are cut out from firing, and the reduction in brake torque is determined while maintaining the same engine speed. The remaining cylinders drive the cylinder cut out. Care must be taken to determine that the action of cutting out one cylinder does not significantly disturb the fuel or mixture flow to the others. For a 4 cylinder spark ignition (petrol engine) engine the following steps are performed:

1. The engine is started and is run at the rated speed.
2. The maximum load of the engine is calculated and is connected to the engine. The engine is now brought to its rated speed .
3. The first cylinder is cut off by shorting the spark plug .
4. Now because the cylinder is cut off the engine speed is reduced.
5. Hence the load is to be varied such that the engine comes back to its rated speed.
6. Then the first cylinder is again started and the same is repeated for all the other cylinders.

The engine can be loaded using a dynamo meter (hydraulic or eddy current)

Only the first of these four methods has the potential for measuring the true friction of an operating engine. The last three methods measure the power requirements to motor the engine. The motoring losses are different from the firing losses for the following reasons;

- Only the compression pressure and not the firing pressure acts on the piston, piston rings and bearings. The lower gas loading during motoring lower the rubbing friction
- Piston and cylinder bore temperatures are lower in motored operation. This results in greater viscosity of the lubricant and therefore increased viscous friction. In addition, piston-cylinder clearances are more during motoring operation which tends to make friction lower. However, in firing operation, the lubrication of the top ring near the TDC is inadequate to maintain normal hydrodynamic lubrication with the higher gas pressures behind the ring. The resulting boundary friction in this region makes friction in the firing engine higher.

Chapter 5

EXPERIMENTAL DETAILS FOR DIRECT INJECTION HEAVY DUTY DIESEL ENGINE

TEST ENGINE

Engine test to predict the friction mean effective pressure and friction Power was conducted in a four stroke, four-Cylinder, off-highway, direct injection heavy duty, diesel engine. Specification of the test engine, used for the study is given in the Table 2.

Table 2. Engine specifications for DI

1.	Engine type	Off-Highway, DI Diesel Engine Turbocharged
2.	Displacement	4399 cc
3.	Compression Ratio	18.3:1
4.	No. of Cylinders	4
5.	Maximum Power Output	74.2 kW @ 2200 rpm
6.	Torque	385 N-m @1300 rpm

ENGINE TEST BENCH DETAILS

Test engine coupled with the appropriate AC dynamometer and instrumented with fuel consumption measurement unit, pressure sensor, angle encoder, speed sensor, temperature indicators, data acquisition system etc, is shown in the figure 12 & 13. Engine tests were conducted at two speeds and four loads for each engine lubricant, details of operating condition are given in Table 3. Pressures at each operating speed and load was recorded and IMEP (average of 18 and 30 cycle for 1000 rpm and 2000 rpm respectively) for each operating condition was computed by using a matlab programme, given in Annexure I. Friction power (FP) is then calculated by subtracting Brake power (BP) from Indicated power (IP), at each operating point for both engine lubricants.



Operating Conditions	Values
Speed (rpm)	1000 and 2000
Torque (Nm)	50, 100, 200, 300
Temperature oil (°C)	90 ± 5
Temp Coolant (°C)	85-90

Figure 12 Test bench setup

Table 3. Test operating conditions

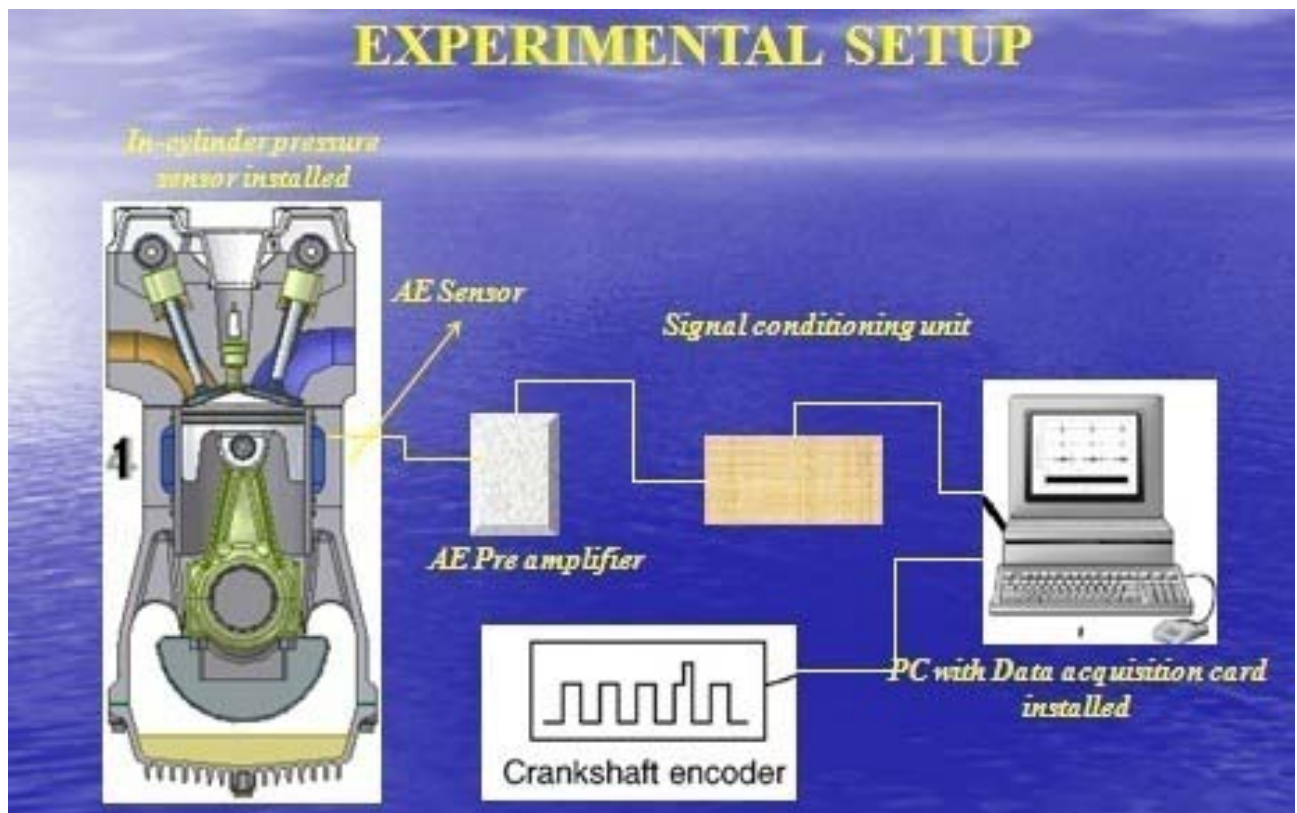

Figure 13. Schematic representation of experimental test set-up

ENGINE LUBRICANTS

Engine lubricants used in the experimental study are as follows;

Oil 'A' SAE 20W-50

Oil 'B' SAE 10W-30

Both of these engine lubricants are commercially available, complying with API CG-4 performance category level. Typical physical characteristics of both engine lubricants are shown in Table 4. Viscosity Index is a measure of the variation in kinematic viscosity due to changes in the temperature of a petroleum product. A higher viscosity index indicates a smaller decrease in kinematic viscosity with increasing temperature of the lubricant.

It is to be noted that engine oil 'A' SAE 20W-50 was taken as baseline engine lubricant for friction studies. Engine lubricants were chosen in such a way that both lubricants, having same additive package but are of different viscosity grade.

Table 4. Physical characteristics of both engine lubricants

Properties	Oil SAE 10W-30	Oil SAE 20W-50
Viscosity@ 40°C cst	11.0	17.5
Viscosity@100°C cst	7.2	15.3
Viscosity Index	143	125

PRESSURE SENSOR

In-cylinder combustion pressure was measured by a Kistler type 6125A piezoelectric pressure sensor. The sensor was fixed in the combustion chamber of cylinder number 1. The sensor is made of polystable quartz elements, and ground insulated to avoid electrical interferences due to ground loops, it does not require additional cooling. It has also been specially designed to work at high temperatures and for precision measurement of pressure of an internal combustion engines. Table 5 summarizes the brief specifications of the pressure sensor.

Table 5. Pressure sensor specifications

S.No.	Parameter	Value
1	Pressure range	0 – 25 MPa
2	Sensitivity	-15.8pC/bar
3	Linear error	±0.2FSO
4	Temperature range	-50°C upto 350°C

METHODOLOGY

Test engine was tuned as per the OEM’s recommendations before start of the test

- Engine oil was drained and flushed to remove the surface active chemistry of the previous oil.
- Initially the baseline engine oil ‘A’ SAE 20W-50 was charged into an engine for its test run and then oil ‘B’ SAE 10W-30 was used for the study. For each engine lubricant, new oil filter was used and the test was run for three times for each engine lubricant.
- Indicated mean effective pressure (IMEP) measurements (average of 18 power cycle for 1000 rpm and 30 power cycle for 2000 rpm) was done for calculating the FMEP and also friction power at all the test operating conditions mentioned above.
- Engine oil and coolant temperatures were controlled within the range of $90^{\circ}\text{C} \pm 5$ and 85°C to 90°C respectively at all test points
- Brake specific fuel consumption (bsfc) in g/kWh was calculated at each test operating point.

5.1 RESULTS AND DISCUSSIONS

Indicated Mean Effective Pressures (IMEP) at different loads and speeds for both engine lubricants were measured from the experimental setup. Brake Mean Effective Pressure (BMEP) was calculated from the measured value of the engine brake power obtained from the engine dynamometer, by using the following relation;

$$\text{Brake Power} = \text{BMEP} * V_d * N / K$$

Where, V_d Engine displacement

N Engine revolution per minute

$K = 2$ for 4-Stroke engine

1 for 2-stroke engine

FMEP was calculated by taking difference of IMEP and BMEP. Mean effective pressures, test results were tabulated and represented in Table 6 and 7 for both oils at different torque and speeds. Indicated power from IMEP, Brake power measured from engine dynamometer and Friction power for both engine lubricants at different torque points and speeds were calculated and tabulated in Table 8.

Graphical representation of the variation of these mean effective pressures with different torque points at speeds (1000 rpm and 2000 rpm) for both engine lubricants are given in figure 14 and 15. Comparison of Friction mean effective pressure, FMEP and Friction power versus torque for both engine lubricants are shown in figure 16 and 17.

Table 6. Mean effective Pressures at different load for engine lubricant SAE 20W-50 at both speeds

Torque (Nm)	IMEP		BMEP		FMEP	
	1000 (rpm)	2000 (rpm)	1000 (rpm)	2000 (rpm)	1000 (rpm)	2000 (rpm)
50	2.00	2.85	1.42	1.44	0.57	1.41
100	3.21	4.29	2.86	2.86	0.36	1.43
200	6.21	6.90	5.71	5.70	0.50	1.20
300	9.43	9.38	8.57	8.57	0.86	0.82

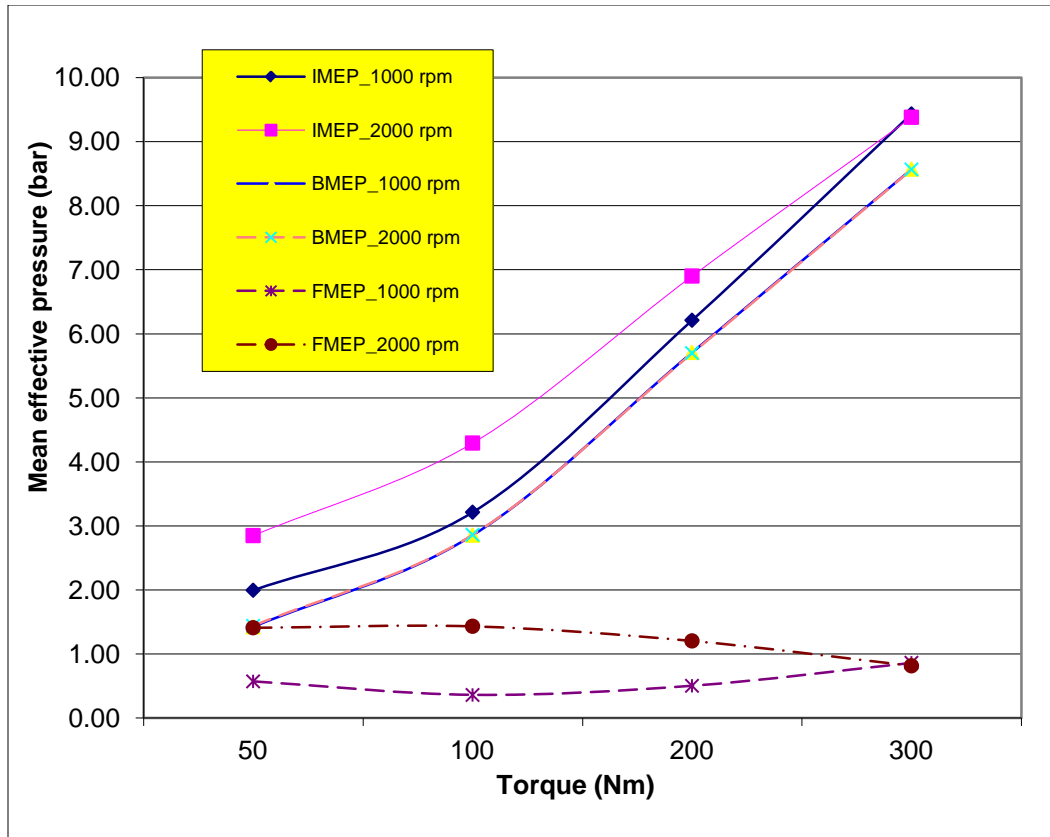

Figure 14. Graphical representation of variation of mean effective pressures with load (Nm) for engine lubricant SAE 20W50 at both speed

Table 7. Mean effective Pressures at different load for engine lubricant SAE 10W-30 at both speeds

Torque (Nm)	IMEP		BMEP		FMEP	
	1000 (rpm)	2000 (rpm)	1000 (rpm)	2000 (rpm)	1000 (rpm)	2000 (rpm)
50	2.12	2.79	1.43	1.43	0.69	1.36
100	3.38	4.24	2.87	2.86	0.51	1.39
200	6.25	6.66	5.72	5.71	0.52	0.96
300	9.34	9.31	8.57	8.59	0.77	0.72

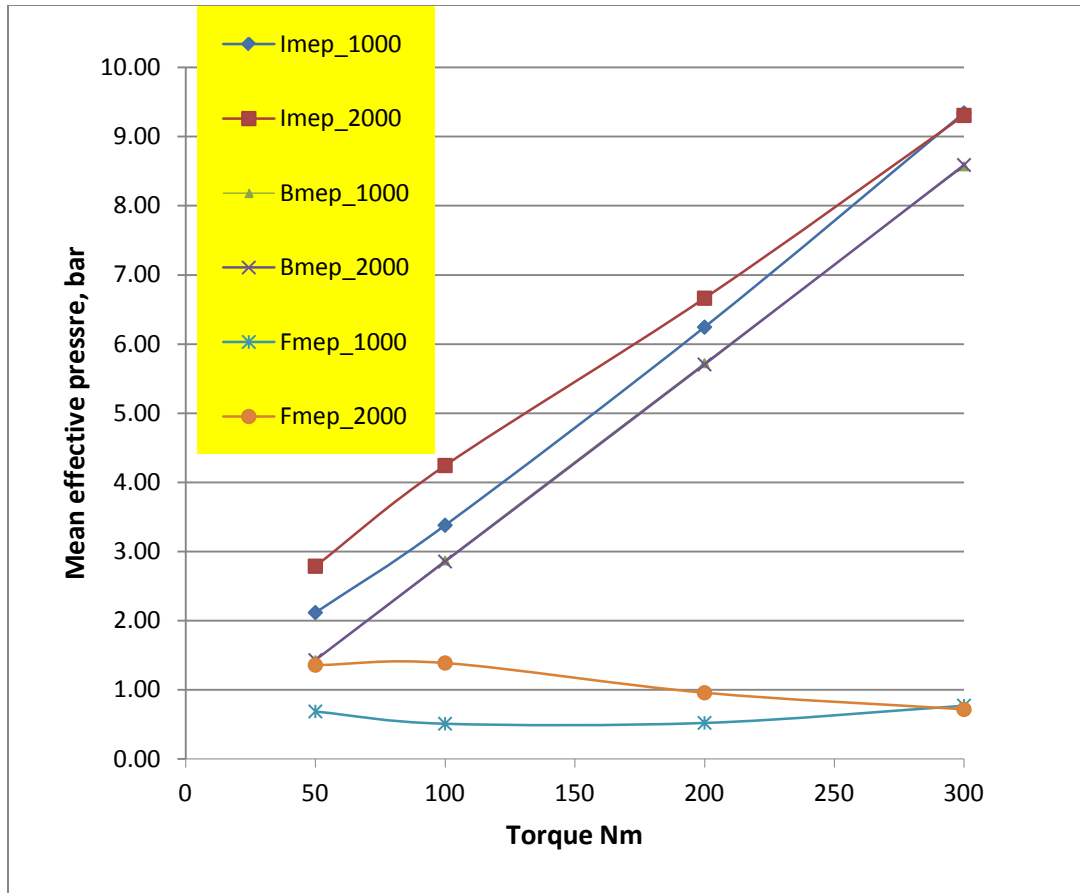

Figure 15. Graphical representation of variation of mean effective pressures with load for engine lubricant SAE 10W-30 at both speed

It has been observed from the friction mean effective pressures results that, there is significant rise in engine friction mean effective pressure with the increase in engine speed (rpm) at all load points for both engine lubricants, which indicates that speed is one of the most important factors influencing the engine friction. Other parameters on which engine friction depend are engine load, oil viscosity, oil temperatures etc. Since the oil temperature was controlled ($90 \pm 5^\circ\text{C}$) for both engine lubricants, hence the effect of engine lubricant temperature on friction can be ignored.

Table 8. Indicated power (IP), Brake power (BP) and Friction power (FP) for both oils under prescribed engine operating conditions

Speed rpm	Torque Nm	IP (kW)		BP (kW)		FP (kW)	
		Oil A	Oil B	Oil A	Oil B	Oil A	Oil B
1000	50	7.31	7.76	5.22	5.24	2.09	2.52
1000	100	11.78	12.38	10.46	10.51	1.32	1.87
1000	200	22.75	22.87	20.91	20.96	1.84	1.91
1000	300	34.58	34.24	31.42	31.41	3.16	2.83
2000	50	20.89	20.44	10.55	10.49	10.34	9.95
2000	100	31.48	31.12	20.98	20.94	10.50	10.18
2000	200	50.60	48.85	41.78	41.83	8.83	7.02
2000	300	68.81	68.20	62.83	62.95	5.98	5.25

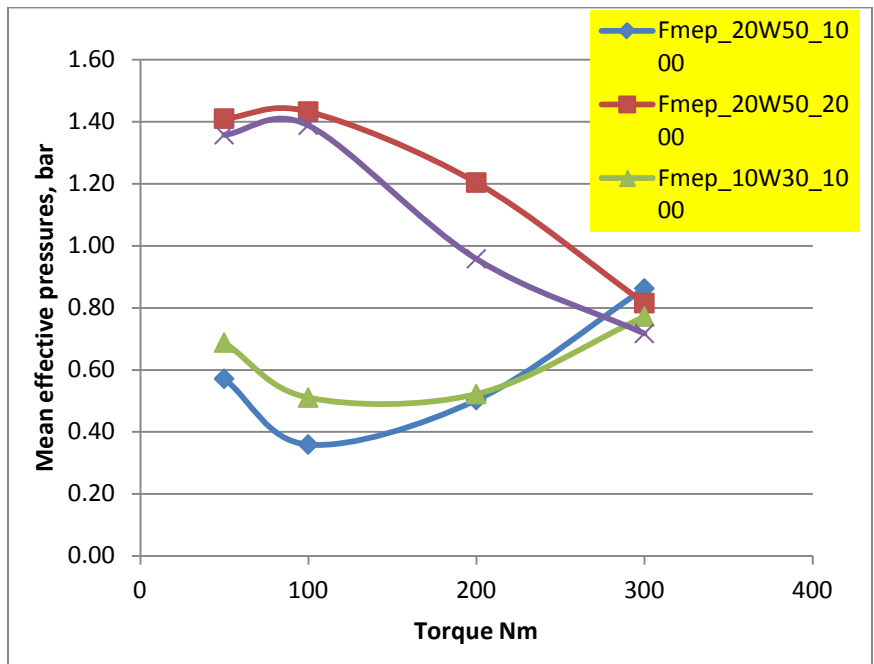

Figure 16. Comparison of Friction mean effective pressure, FMEP vs torque for both engine lubricants

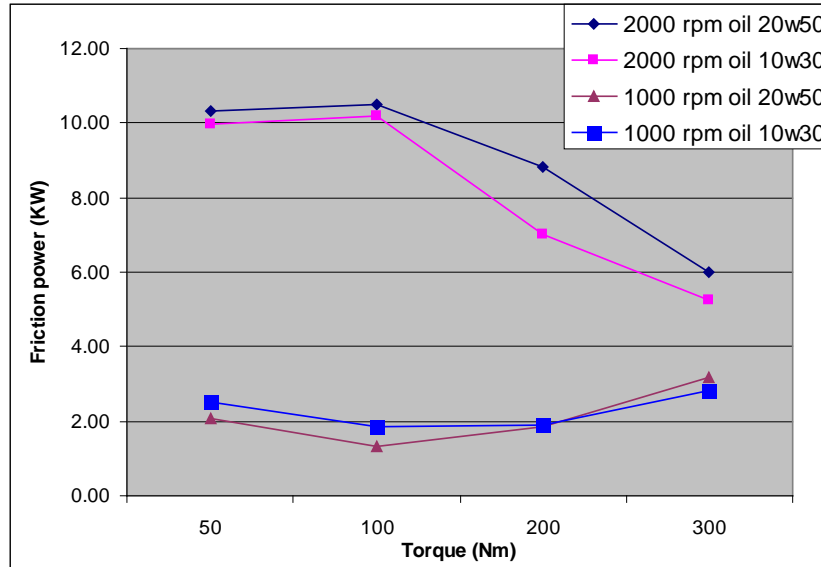

Figure 17. Engine friction power at different operating conditions for both oils

Main focus of this study is to understand the effect of engine lubricant’s viscosity on engine friction and fuel consumption. It’s a known fact that hydrodynamic friction is strongly influenced by viscosity of the lubricant and piston ring assembly and bearings are predominantly operating in these regime during the engine operation at high speed. Also, these are the major contributor in friction power loss as discussed in the introduction chapter; focus of our discussion would be restricted to establish relation between hydrodynamic friction with viscosity and other engine operating parameters.

Figure 16 and 17 shows the variation of FMEP and friction power with respect to torque at speeds (1000 rpm and 2000 rpm) for both engine lubricants. At high speed and low load, simulating the hydrodynamic lubrication conditions (prevalent in piston ring assembly and bearings), engine friction power is significantly higher as compared to the low speed and low load. This may be illustrated with the following relations showing a strong dependence of hydrodynamic friction power on speed and oil viscosity;

It is assumed that piston rings-liner pair is operating in hydrodynamic lubrication regime at high engine speed during mid stroke region. Hence the governing equation for piston ring/liner could be Reynolds equation. Full Reynolds equation [10] in three dimensional form, for any bearing would be;

$$\frac{\partial}{\partial x}(h^3 \frac{\partial P}{\partial x}) + \frac{\partial}{\partial y}(h^3 \frac{\partial P}{\partial y}) = 6\eta (Udh/dx + Vdh/dy) + 12\eta dh/dt$$

Simplifying this equation for piston ring, by assuming an infinitely long bearing, very small width as compared to the circumferential length, pressure gradient in circumferential direction can be neglected i.e $\partial P/\partial y=0$, also neglecting squeeze at TDC. And also velocity in y direction is assumed to be zero i.e $V=0$ and U is piston velocity. Reynolds equation would be as follows;

$$\partial/\partial x(h^3\partial P/\partial x) = 6\eta(Udh/dx) \quad 16$$

Hydrodynamic pressure distribution of oil film along x direction can be calculated by integrating the above equation.

$$dP/dx = 6\eta U/h^2 + C1$$

The minimum oil film thickness can be related to the piston velocity by following relationship

$$h \sim [6\eta U/ (dP/dx)]^{1/2} \quad 17$$

It is also known from the above Reynolds equation that frictional force for this pair is proportional to the sliding velocity and viscosity of oil as follows;

$$F \sim (U\eta/h) \quad 18$$

Combining eq. 17 and 18, it may be seen that frictional power loss (FP) for hydrodynamic lubrication conditions related with piston speed and viscosity as follows;

$$FP \sim \eta^{1/2} U^{3/2} \quad 19$$

For journal bearings, under light loaded conditions, Petroff equation [10] suggested that the friction power loss would vary linearly with lubricant viscosity and square of angular speed.

$$F = 2\pi\eta\omega^2LR^3 / c$$

Where F is the friction power loss (watts), η is the lubricant dynamic viscosity (mPa.s) appropriate to the bearing, ω is the engine's angular speed (rad/s), L is the bearing width (m), R is the bearing radius (m) and c is the bearing radial clearance (m) for a heavily loaded bearing.

Friction power loss in hydrodynamic lubrication conditions (piston ring assembly and bearings) is actually a combined effect of load, piston speed and oil viscosity.

It may be inferred from the above discussion that speed of sliding pair is the main parameter, by which FMEP or friction power is strongly influenced. It may be observed from figure 16 and 17 that friction power/FMEP for lubricant SAE 10W-30 at high engine speed (2000 rpm) was lower than the SAE 20W-50 for all load/torque points. It may be interpreted that by using a lower viscosity grade engine lubricant at high speed, there is reduction in engine friction power/FMEP which was also corroborated by the bsfc (g/kWh) results as shown in Table 9.

At high speed, high load, the friction power is reduced to a level comparable to that of the low speed, high load condition; this may be explained with the help of well known fact that the contribution of friction as a percentage of indicated power output reduces as load increases, indicated in the figure 16 and 17 for high speed (2000 rpm) case. It may also be deciphered that shearing of the oil film's sub-layers would be easier at high speed and high load which helps in friction reduction, emanated due to shearing resistance in hydrodynamic lubrication conditions.

At low speed, for all load levels (engine operating in boundary and mixed lubrication regime), it is observed that there is marginal change in engine friction for both oils.

It has been observed from FMEP (bar) and friction power (FP) graphs that the friction power is lower for speed (1000 rpm) as compared to the friction at high speed (2000 rpm). At low speed and high load, it may be assumed that piston ring assembly is also operating in boundary or mixed lubrication regime for most of its operating time in addition to the valve train system (operating in boundary lubrication condition). Among the piston ring assembly pack, the highest contributor to friction in an engine cycle are the top ring around top dead centre (TDC) and oil control ring throughout the engine cycle, which are operating in boundary lubrication conditions. Whereas at low load and low speed, the contribution of top ring friction at TDC is reduced, as observed in the graphs and the main contributor towards friction would be the oil control ring as seen in the FMEP and the friction power graphs. At low speed operation it is observed that higher viscosity grade oil performed comparatively well against the low viscosity grade oil, at all load points.

Brake specific fuel consumption (bsfc) at speed of 2000 rpm at all load point of an engine for both engine lubricants were calculated. Tabulated bsfc (g/kWh) is shown in Table 9; percentage reduction in bsfc (g/kWh) with the use of lower viscosity grade lubricant was also calculated. Results indicated that, there is significant reduction of fuel consumption of an engine when lower viscosity grade oil was used instead of the recommended grade engine lubricant. Similar trends

were also observed by the authors for gasoline driven vehicle during the chassis dynamometer study [21]

Table 9. Percentage reduction of bsfc (g/kWh) of an engine operating at 2000 rpm

Torque (Nm)	bsfc (g/kWh)		% Reduction
	Oil A	Oil B	
50	372.27	367.30	1.33
100	275.22	269.74	1.99
200	259.26	256.65	1.01
300	234.04	231.46	1.10

Chapter 6

EXPERIMENTAL DETAILS FOR INDIRECT INJECTION LIGHT DUTY DIESEL ENGINE

To investigate the effect of engine lubricant viscosity on fuel economy, another small experimental study was carried out on 4-stroke, 4 cylinder, indirect injection diesel engine coupled with the appropriate eddy current dynamometer and instrumented to measure the fuel consumption, power/torque etc.

TEST ENGINE

Tests were conducted on a four stroke, four-Cylinder, indirect injection diesel engine. Specification of the test engine, used for the study is given in the Table 10.

Table 10: Test engine specification for IDI

1.	Engine type	Multi-cylinder, IDI Diesel Engine
2.	Model	Euro II
3.	Piston Displacement	1405 cc
4.	Compression Ratio	22:1
5.	No. of Cylinders	4
6.	Maximum Power Output	53.5 hp @ 5000 rpm
7.	Torque	85 N-m @ 2500 rpm

TEST ENGINE LUBRICANTS

Test engine lubricants used in the experimental study are as follows;

Oil 'C' SAE 15W-40

Oil 'D' SAE 5W-30.

Both oils were complying with API CF-4 level performance category. It is to be noted that recommended engine oil C was taken as baseline lubricant for fuel consumption studies.

EXPERIMENTAL SET UP

Test engine coupled with the appropriate eddy current dynamometer ECB 200; instrumented with fuel consumption measurement unit, power/torque measurement system etc. Fuel

consumption was measured by using AVL 733 S fuel measurement unit with least count and accuracy of 0.001 Kg/h and 0.12% respectively.

METHODOLOGY

FUEL ECONOMY EVALUATION

- Installation of test bench comprising of diesel engine coupled with the appropriate engine dynamometer and instrumented with various measuring equipments.
- Induction run and Baseline engine Performance (M_1): Induction run on test engine charged with Oil 'C' was conducted for 20 hrs as per the test cycle given in the Table 11.
- After completion of induction run, the baseline engine performance (M_1) at full load, including fuel consumption measurement was taken at following speed points; 40%, 60%, 80% and 100% of rated speed.
- After completion of the performance (M_1) of engine charged with Oil 'C', engine was flushed with the high detergency flushing oil.
- Oil 'D' was charged for conducting the Induction run of 20 hrs as per the test cycle given in the Table 11 and final performance (M_2) at full load, including fuel consumption measurement was taken at following speed points; 40%, 60%, 80% and 100% of rated speed.

The fuel consumption was expressed as the average of three consecutive reading at each steady state conditions, during M_1 and M_2 . The average bsfc in (g/kWh) at M_1 (average of four averaged test points) and M_2 (average of four averaged test points), was used to determine the fuel economy benefits as given below:

$$\% \text{ FE} = \frac{100 \times (\text{Avg. } M_1 - \text{Avg. } M_2)}{\text{Avg. } M_1}$$

FE: Fuel efficiency at steady state

M_1 : Fuel consumption at steady state for engine oil C

M_2 : Fuel consumption at steady state for engine oil D

Table 11: Induction Run Test cycle [22]

<i>Induction cycle</i>		
Duration(min.)	Speed	Load
10	Idle	-
50	60% of rated speed	75%
30	80% of rated speed	100%
30	100% of rated speed	50%

6.1 RESULTS

Engine performance results at full load, for both engine lubricants are given in the Table 12 and 13. Comparative results of brake specific fuel consumption bsfc (g/kWh) for both engine lubricants at various speeds are given in Table 14. Graphical representation of comparative performance characteristics curves (Torque, Power and bsfc with respect to the speed of the engine) are provided in figure 18.

Brake specific fuel consumption (bsfc, g/kWh) calculations revealed that there is significant improvement in fuel efficiency, when lower viscosity grade engine oil ‘D’ (SAE 5W-30) was used in the engine as compared to the baseline oil ‘C’ (SAE 15W-40). Graphical representation of the comparative results is shown in figure 19. Calculations of Percentage Fuel Efficiency (%FE) show 2.18% improvement for engine charged with the low viscosity oil i.e, SAE 5W-30.

Table 12. Test results of full load Performance of engine charged with Engine Oil ‘C’

Speed (rpm)	Torque (N.m)	Fuel Consumption (Kg/h)	Power (kW)	bsfc (g/kWh)	Oil temp (oC)	Water out temp (oC)	Air in (Kg/h)
2000	72.65	4.63	15.21	304.70	77	69	102.27
2500	74.60	5.88	19.52	301.45	87	76	128.25
3000	77.05	7.04	24.19	291.11	91	78	158.20
3500	76.25	8.07	27.93	289.04	98	80	186.02
4000	74.73	9.46	31.28	302.41	112	81	215.73
4500	71.70	10.16	33.77	298.85	125	82	241.14
5000	64.80	11.44	33.91	337.29	126	85	270.82

Table 13. Test results of full load Performance of engine charged with Engine Oil 'D'

Speed (rpm)	Torque (Nm)	Fuel Consumption (kg/hr)	Power (kW)	bsfc (g/ kW.h)	Oil temp (oC)	Water out temp (oC)	Air in (Kg/hr)
2000	73.27	4.74	15.34	309.17	80	68	106.69
2500	76.69	5.91	20.07	294.70	88	77	136.57
3000	79.47	7.13	24.95	285.77	90	75	164.22
3500	78.17	8.17	28.64	285.47	98	76	196.04
4000	77.72	9.56	32.54	293.67	106	76	228.75
4500	74.24	10.47	34.97	299.41	111	76	252.72
5000	69.78	11.68	36.52	319.95	114	76	285.00

Table 14: Comparative results of bsfc (g/kWh) for both engine lubricants at different speeds under steady state conditions

Speed (rpm)	Oil C bsfc (g/kWh)	Oil D bsfc (g/kWh)
2000	304.70	309.17
2500	301.45	294.70
3000	291.11	285.77
3500	289.04	285.47
4000	302.41	293.67
4500	300.94	299.41
5000	337.29	319.95

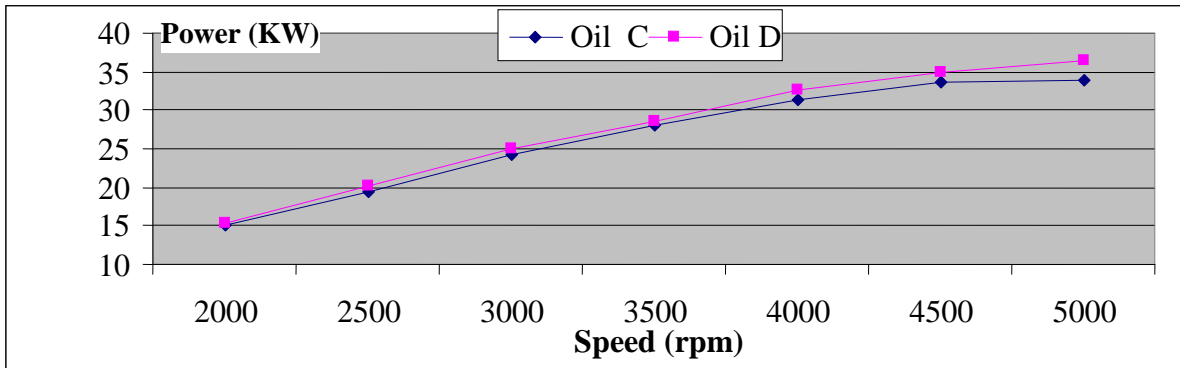
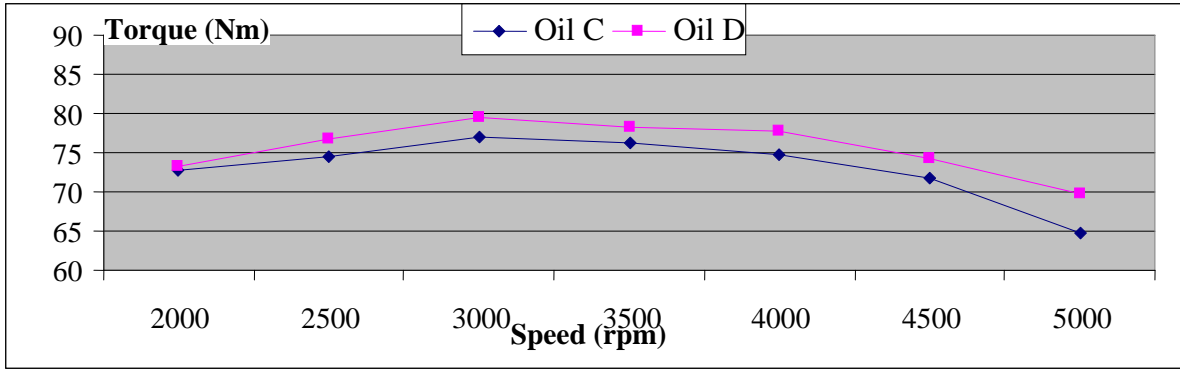

Figure 18. Comparative Performance characteristics curves for both engine oils

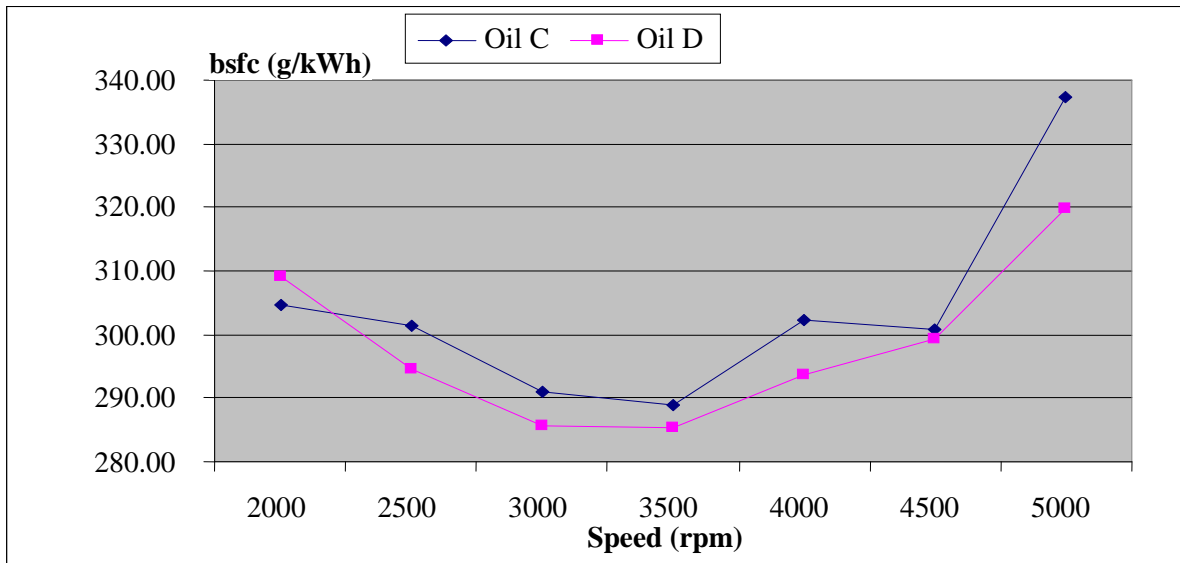

Figure 19. Comparative bsfc (g/kWh) of Oil C and Oil D

Chapter 7

ANALYSIS OF DOMINANT FACTOR INFLUENCING FRICTION POWER BY DOE

To understand the effect of various operating parameters and other factors, varying simultaneously, on engine friction characteristics a simple full factorial experimental design was used. Statistical Design of Experiment (DOE) is an efficient tool for optimizing the variables in such a way that response variables yield the desired results. A full factorial DOE, with three factors (speed, load and engine oil viscosity) each having two levels (low and high), was used for investigating the most dominant among three factors which influence engine friction significantly with 95% confidence level. The number of replicates was chosen as two and a total of 16 experiments were performed. Table 15 gives the details of factors and setting of factor levels and Table 16 gives the typical viscosity values for the engine lubricants used for investigations.

Table 15. Factors with its levels of experiment

Factors	Low Setting	High Setting
Speed (A)	1000 rpm	2000rpm
Load (B)	50 Nm	350 Nm
Oil type (C)	SAE 10W-30	SAE 15W-40

Table 16. Physical properties of both engine lubricants

Properties	Oil SAE 10W-30	Oil SAE15W-40
Viscosity@ 40°C cst	11.0	14.5
Viscosity@100°C cst	7.2	11.0
Viscosity Index	143	137

RESULTS AND DISCUSSIONS

The test matrix comprising of the factors such as speed, load and oil viscosity are presented against the response variable of friction power (FP) in Table 17 for the steady state conditions. The test results revealed that friction power response is influenced by the variables such as engine speed, load and engine lubricant type (viscosity). Since the experiments were conducted

in controlled conditions for both engine lubricants, hence the effect of engine lubricant temperature may be neglected as both lubricants were tested under identical conditions.

It may be observed from the results (Table 17) that the friction power of an engine charged with engine lubricant SAE10W-30 increases approximately 5 times with the increase in engine speed from 1000 rpm to 2000 rpm although load was kept constant at 50 Nm for both speed points (run order 1 & 5). Same is true for an engine charged with other engine lubricant SAE15W-40 (refer run order 2 & 16). So it may be deciphered from the above results that at high speed and low load, simulating the hydrodynamic lubrication conditions, engine friction power is significantly influenced by the speed of an engine.

Engine load also play a vital role in engine friction. With the increase in load from 50Nm to 350 Nm at high speed, 2000 rpm there is reduction in friction power for both engine lubricants, SAE 10W-30 and SAE 15W-40 (refer run order 1 & 3, 2 & 6). This may be explained with the help of well known fact that the contribution of friction as a percentage of indicated power output reduces as load increases. Also the shearing of the oil film's sub-layers would be easier at high speed and high load which helps in friction reduction, emanated due to shearing resistance in hydrodynamic lubrication conditions. At low speed, 1000 rpm and for both load levels 50 and 350 Nm, there is marginal change in engine friction (run order 7 & 12). Also it may be observed that at high speed, high load i.e 2000 rpm & 350 Nm, the friction power is reduced to a level comparable to that of the low speed, high load condition i.e 1000 rpm & 350 Nm (refer run order 3 & 4). It was assumed that at low speed engine operates in boundary and mixed lubrication regime and with the increase in speed of an engine there is significant increase in friction power. Test results also illustrate that at high speed and low load condition, engine lubricant viscosity plays a vital role in influencing engine friction (run order 1 & 2, 9 & 14), assumed to be operating in hydrodynamic lubrication regime, which indicates approximately 20% reduction in friction. So it may be concluded that, there is a reduction in engine friction when lower viscosity grade engine lubricant (SAE 10W-30) was used instead of higher viscosity grade lubricant (SAE15W-40) for engine running at higher speeds.

In order to determine the dominant factor among these three factors (speed, load and viscosity of an engine lubricant) under investigation, DOE approach, full factorial method was adopted using the Minitab software (10) for analyzing the results.

Analyzing the factorial design for the dominant factor with 95% confidence level, a factorial fit was used which includes main effects, first order interactions and second order interactions with estimated coefficient given in Annexure II.

Table 17. Full Factorial Design of Experiment with Response Variable Friction Power (FP), kW

Run Order	Speed (rpm)	Load (Nm)	Oil Type	Response FP(kW)
1	2000	50	10w30	10.34
2	2000	50	15w40	12.17
3	2000	350	10w30	2.5
4	1000	350	10w30	2.56
5	1000	50	10w30	2.09
6	2000	350	15w40	2.67
7	1000	350	10w30	2.23
8	1000	350	15w40	2.85
9	2000	50	15w40	12.78
10	2000	350	15w40	4.6
11	1000	50	15w40	1.77
12	1000	50	10w30	2.1
13	2000	350	10w30	2.83
14	2000	50	10w30	10.04
15	1000	350	15w40	2.12
16	1000	50	15w40	2.08

In order to determine the significant factors among the main effects, three two-way effects and one three-way effect, p-value were used for screening. It is to be noted that all three main effects; speed, load, oil viscosity and 2 two-way interaction; speed-load and speed-viscosity are significant parameters which affect engine friction with 95% confidence level, as p-value is less than 0.05 for all these five cases. Table 18 shows the estimated effects and coefficients of all the significant factors with p-values. Which indicates that all factors are significant at 0.05 level (95%confidence level).

Table 18. Estimated effects coefficients with p-values.

Factors	Effects	Coeff	P-values
Constant		4.733	0.000
speed (A)	5.016	2.508	0.000
load (B)	-3.876	-1.938	0.000
Vis (C)	0.794	0.397	0.022
speed*load (AB)	-4.306	-2.153	0.000
speed*Vis (AC)	0.834	0.417	0.017

$$\text{Friction Power (FP)} = 4.733 + 2.508A - 1.938B + 0.397C - 2.153 A*B + 0.417 A*C$$

It can be seen from the Table 18 that engine friction power increases with the increasing speed (5.016) and engine lubricant viscosity (0.794). But friction power response decreases with the increase in the load of a fired engine (-3.876), which is true, as the percentage contribution of friction power of a fired engine is very less as compared to the power output at high loads.

To identify and screen the active factors (effects) which influence the response, friction power significantly, normal probability plot and Pareto chart were used. In figure 20, the normal plot of the all factors; main effects, first order interaction and second order interaction points were plotted. It can be inferred that points that do not fit the line well, usually signal active effects. Active effects are larger and farther from the fitted line. In our case factors A, B, AB, C, and AC are considered to be the significant factors.

A Pareto chart of the effects is another tool, shown in figure 21, which is very much useful in determining the active effects. It also indicated the active effects, same as observed in the normal plot. Both normal plot and Pareto chart uses the same value of $\alpha = 0.05$ for determining significance of effects with 95% confidence level.

After screening out the unimportant effects, a final factorial fit comprising of all important effects was designed. Details of the factorial fit of significant factors are given in Annexure III.

In order to visualize the effects, a main effects plot and an interaction plot were generated from the significant factors. Figure 22 represents the main effects plot; it is shown that speed has a bigger main effect as compared to factors load and engine lubricant viscosity. That is the line connecting the mean responses for speed 1000rpm and speed 2000 rpm has a steeper slope than

both load and viscosity connecting line at low and high setting. Although the speed appears to affect friction power more than the load and oil viscosity, it is very important to look at the interaction plot.

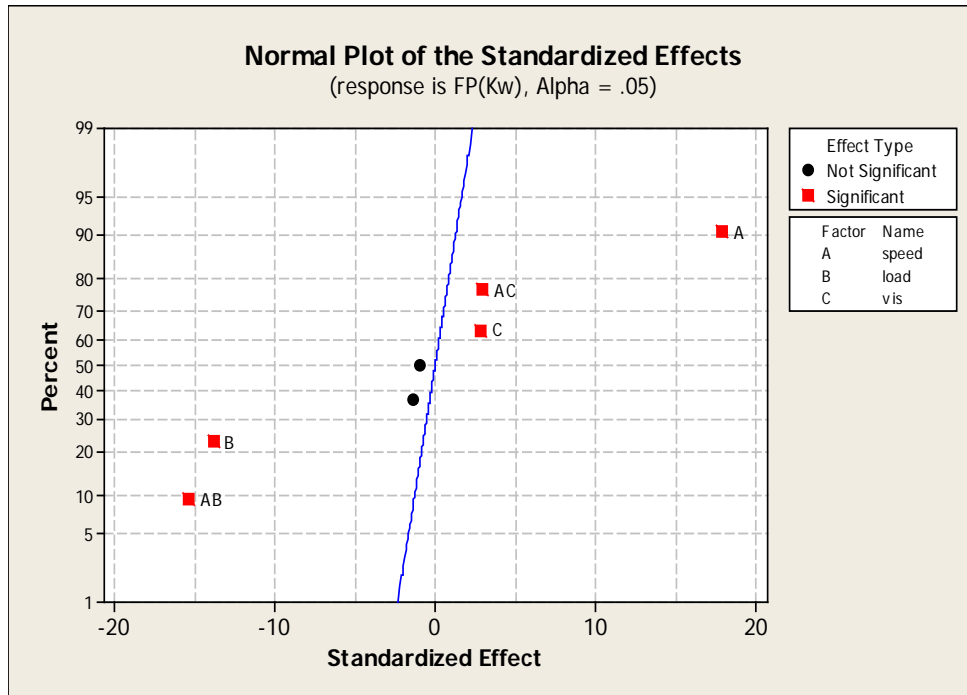

Figure 20. Normal plot of all factors (Effects) influencing the response Friction Power

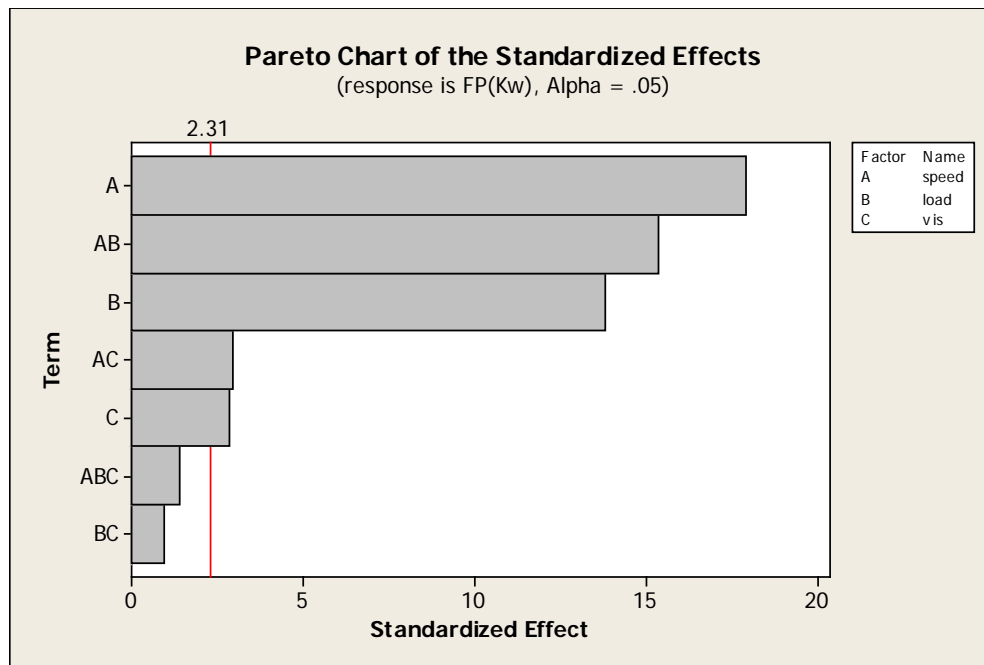

Figure 21. Pareto Chart for all factors (effects) influencing the response Friction Power

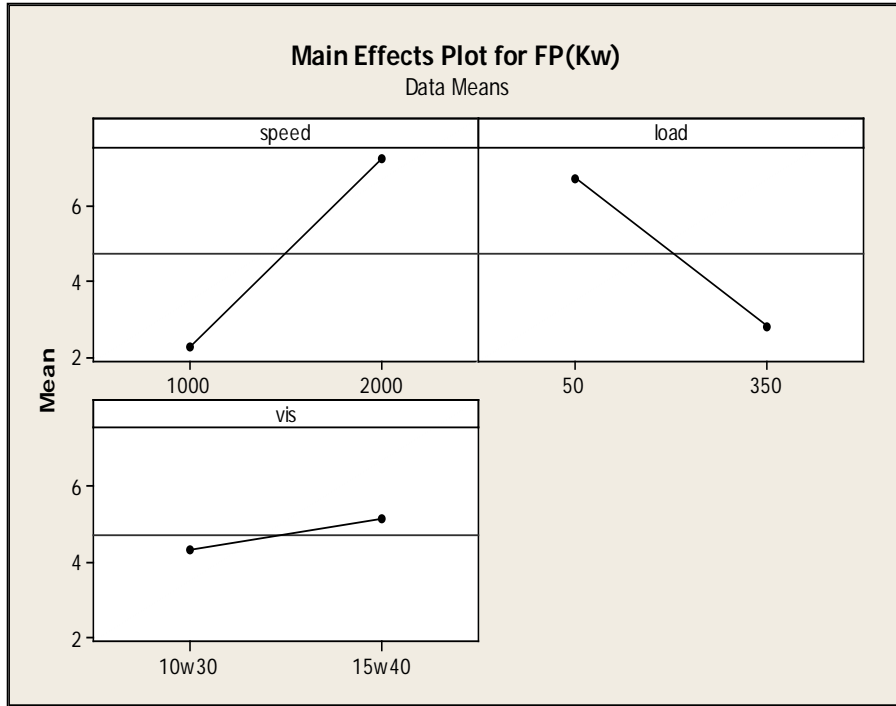

Figure 22. Main Factors (effects) plot speed, load and lubricant viscosity for the response Friction Power

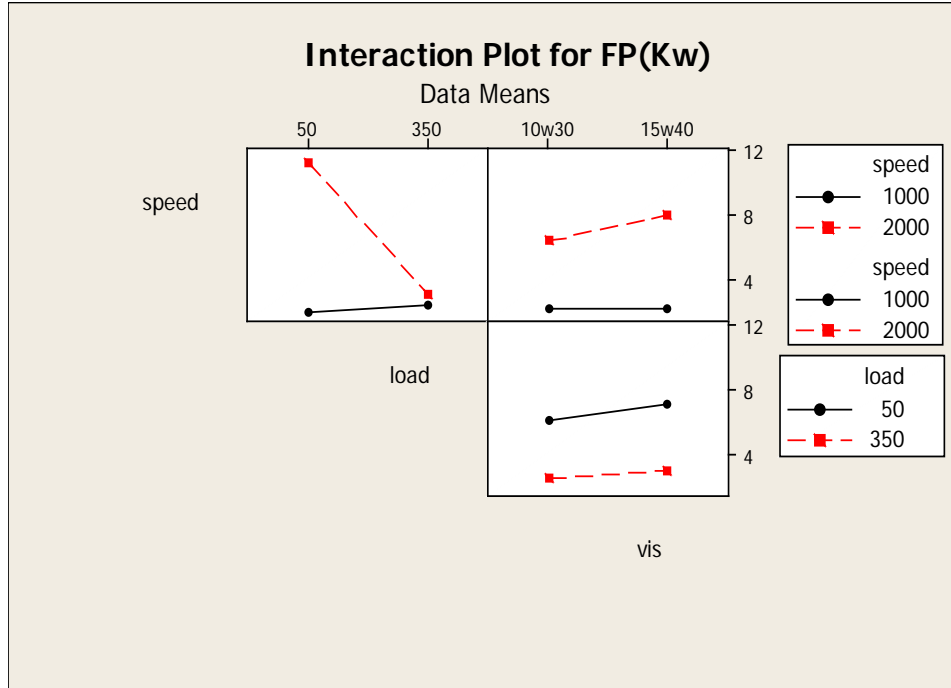

Figure 23. Interaction Plot of speed-load, speed-viscosity, load-viscosity for the response Friction Power

An interaction plot can magnify or cancel out main effects hence evaluating interactions is extremely important. An interaction plot shows the impact of changing the settings of one factor on another factor.

The significant interaction between speed, load and viscosity is shown in figure 23. It can be seen from the figure 23 that two lines with differing slopes in the interaction plot of speed and load. Friction power for high speed, low load condition is greater than low speed, low loads operating condition. It is expected due to the dominance of hydrodynamic friction at high speed, low load condition and friction is due to the shearing resistance of the oil film. This hydrodynamic friction occurred in the piston ring assembly and journal bearings at high speed and can be reduced to some extent by using low viscosity grade oil, which is shown in the next interaction plot of speed and engine lubricant viscosity.

From the interaction plot of speed and engine lubricant type (viscosity) it has been observed that friction power is less for low viscosity grade oil when the engine is running at high speed (2000 rpm) whereas, at low speed for both load points, the change in friction power with oil viscosity is marginal which complies with the theoretical prediction that boundary lubrication is not a function of engine lubricant viscosity. Boundary lubrication friction depends on surface roughness, normal load, and type of friction modifiers and is not a variable dependant on lubricant viscosity only.

Chapter 8

CONCLUSION AND RECOMMENDATION

In the present study, effect of engine lubricant viscosity on friction characteristic and fuel consumption of a diesel engine (for both direct injection and indirect injection) was investigated. The experimental study also investigates some of the important facts about friction mean effective pressure (FMEP), friction power dependence on the engine operating variables such as engine speed, engine torque and engine lubricant viscosity. A full factorial DOE, with three factors (speed, load and engine oil viscosity) each having two levels (low and high), was also used for investigating the most dominant factor among three factors which influence engine friction significantly with 95% confidence level. An empirical model was developed based on the selected parameters i.e. speed, load and engine lubricant viscosity for predicting the distribution of possible outcomes (friction power) for the Off-highway, DI diesel engine. This model may be used to predict the friction power of a fired engine at 95% confidence level for the range of parameters considered in this investigation. Following points may be summarized from this limited experimental study;

- Engine hydrodynamic friction force is strongly dependent on the engine oil viscosity as evident from the theoretical and experimental study.
- Engine FMEP and friction power can be reduced by using the lower viscosity grade oil at high speed and at all load points without affecting the engine performance adversely.
- There is marginal change in engine FMEP and friction power at low speed at all load points, for both oils. Which strengthens the fact that engine oil viscosity effect is insignificant at low speed (operating in boundary and mixed lubrication regime)
- Significant reduction in fuel consumption in terms of bsfc (g/kWh) was observed for both DI as well as IDI diesel engine, when lower viscosity grade engine lubricant was used in place of recommended viscosity grade.
- DOE analysis revealed that operating variables such as engine speed, load and lubricant viscosity plays a vital role in influencing the friction power.

- At high speed, engine lubricant viscosity is a vital factor which influences the friction power. Experiments and DOE results indicate that lower viscosity grade engine lubricant reduces the friction power significantly for high speed at both low and high load

RECOMMENDATION FOR FUTURE STUDY

As described above, low viscosity grade engine lubricant reduces friction between engine parts which are in hydrodynamic lubrication regime but for the valve train systems the friction power loss is expected to increase as the lubricant viscosity decreases, since it operates in the mixed/boundary lubrication regime where metal to metal contact is prevalent. So it requires some friction modifiers which attached themselves on the tribo-surfaces via physical or chemical adsorption and forming a protective film and that would prevent the excessive wear of the engine parts operating under mixed/boundary lubrication regime. These thin film keeps on breaking during operations and one must resolve this problem by introducing very fine minute particles (in the range of nano-scale) that will react with the tribosurfaces and results in a protective nanometer scale thick layer on surfaces for reducing the friction. These nano-surface layers would be almost frictionless with very low coefficient of friction and having high shear strength. Synthesized nanomaterial may be added in the low viscosity grade finished lubricant and during normal operation of the engine these nanomaterials react with the engine tribo-surfaces physically or chemically results in formation of very smooth frictionless surfaces. This way we can able to reduce the friction between the contacting surfaces which are in mixed/boundary lubrication regime.

However, to understand the above mentioned mechanism, a detailed study on fuel economy and wear characteristics of a diesel engine needs to be studied. Also, in order to study the wear characteristics of engine charged with nano-material based engine lubricant Acoustic Emission (AE) technique may be an effective tool to analyse and monitor wear. AE has been known as a very effective tool for condition monitoring of rotary machinery/equipments, so by using this novel non-intrusive technique of Acoustic Emission for assessing the friction and wear would extend the scope of AE technique for analyzing friction and wear of an engine and may provide an opportunity for in-service monitoring of efficient engine operation.

9. REFERENCES

1. www.marketresearch.com/ Freedonia Group Inc, World lubricants, February 1, 2009
2. George Gill, Editor. Lube Report (ISSN 1547-3392), Industry News from Lubes-n-Greases, Oct 13, 2010, Volume 10 Issue 41
3. George Fenske, “Impact of Friction Reduction Technologies on Fuel Economy”, Presentation Chicago chapter meeting of the STLE, March 2009
4. Furuhashi S & Sasaki, Effect of oil Properties on Piston Frictional Forces JSAE Review, pp 68-76, Nov 1984.
5. Heywood. J, Fundamentals of Internal Combustion Engine’
6. A. Comfort, An Introduction to Heavy-Duty Diesel Engine Frictional Losses and Lubricant Properties Affecting Fuel Economy-Part I, SAE 2003-01-3225
7. Taylor C.M.(Editor), 1993, Engine Tribology, Elsevier Science Publisher
8. Radimko Gligorijevic et. al., Contribution of Engine oil to Diesel Exhaust Emission and Friction Reduction, The Annals of University of Galati Fascicle VIII, Tribology 2003 Issn 1221-4590.
9. R.I.Taylor et.al, Lubricants & Energy Efficiency: Life-Cycle Analysis, Leeds-lyon Symposium on Tribology, Sept 2004.
10. G.W. Stachowiak & A.W. Batchelor, Engineering Tribology, Elsevier Tribology Series, 24, 1993.
11. R.I.Taylor, “Lubrication Tribology & Motorsport”, SAE 2002-01-3355.
12. R I Taylor, ”Engine friction: the influence of lubricant, Rheology”, Proc Instn Mech Engrs Vol 211 Part J, 1997.
13. Furuhashi, S. A dynamic theory of piston ring lubrication (1st report, calculation). Bull. JSME, 1960; 2: 423
14. Wakuri, Y., Soejima, M., and Taniguchi, T. Oil film behaviour of piston rings (correction of effective pressure region of oil film). Bull. JSME, 1978, 21(152), 295–302.
15. Jeng Y-R. Theoretical analysis of piston-ring lubrication. Part II—Starved lubrication and its application to a complete ring pack. Tribol Trans-STLE 1992;35:707–14.
16. Wakuri Y, Hamatake T, Soejima M, Kitahara T. Piston ring friction in internal combustion engines. Tribol Int 1992;25(5): 299–308.

17. Mufti, R. A. and Priest, M. Experimental evaluation of piston assembly friction under motored and fired conditions in a gasoline engine. *Trans. ASME, J. of Tribology*, 2005, 127, 826–836.
18. Mufti, R. A. and Priest, M. Analysis of piston assembly friction using the indicated mean effective pressure experimental method to validate mathematical models, *Proc. IMechE Vol. 222 Part D: J. Automobile Engineering*, 2008, 1441-1457.
19. Mufti, R. A. and Priest, M., “Effect of Engine Operating Conditions and Lubricant Rheology on the Distribution of Losses in an Internal Combustion Engine *J. Tribol.* October 2009, Vol 131, Issue 4
20. A. Kellaci, R. Mazouzi, B. Khelidj, A. Bounif, “The effect of lubricant rheology on piston skirt/cylinder contact for an internal combustion engine”, ISSN 1392 - 1207. *MECHANIKA*. 2010. Nr.1(81)
21. D.Singh, N.Singh, A.K.Jain, V.K.Chibber & Mukesh Saxena, “Effect of Engine Oil Viscosity on Fuel Economy”, Paper presented and published in proceedings of 5th International Conference on Industrial Tribology-06, Indian Institute of Science, Bangalore (IISc), 30th Nov- 2nd Dec 2006.
22. PCRA test procedure for fuel economy and mass emissions

ANNEXURE I

Matlab programme for cylinder pressure

```
clear all
close all
% break pressure cy1 = 260; cy2= 270; cy3=270
% fire order 1-4-2-3
dTDC=23.2-2.0; % deg
np=500;
L1=216e-3; % connecting rod
R1=132e-3/2; % half of the stroke 76
lam1=L1/R1;
D1=103e-3; % diameter of cy
A1=pi*(D1/2).^2;
V10=A1*2*R1; % swept volume
ratio=18.3;
Vc1=V10/(ratio-1); % 0.05*V10; %30e-6; %(D1/2).^2*pi*hc1;

minlim = 1;
maxlim = 15000;

Ld=[50 100 200 300 350];
datapath{1}='D:\EngineOil_AE\Oil15w40\Test2\Cylinderpressure'; % set data path

filelist=dir(fullfile(datapath{1}, '*.mat'));
for i=1:length(filelist),
    dnumber(i)=filelist(i).datenum;
end
[sd ns]=sort(dnumber);
filelist=filelist(ns);

itemp=1:7; %% temperature
speedid(:,1)=[8 9 10 11 12]'; % speed 1000
speedid(:,2)=[14 15 16 17 18]'; % speed 2000

% base data
for j=1:2

    for i=1:length(Ld),
        datafile=fullfile(datapath{1},filelist(speedid(i,j)).name)
        load(datafile )
        Data=Data/1000; % into V
```

```

if i==1,N=Datacount;Fs=SampleFrequency;end

% Engine speed
Indx(:,i)=Data(1:N,6);
dIndx=diff(Indx(:,i));
nx=find((dIndx(1:end)>1) );
nxx=find(diff(nx)>100);

nxi{j}{i}=(nx(nxx));

Erpm(j,i)=60/(mean(diff(nx(nxx)))/Fs);
% Tias(j,.,i)=hilbertdemod(Data(1:N,2),Fs,Erpm(j,i)/60,2*120)/np*30/pi; %rpm
Tiass{j}{i}=60./((diff(nx(nxx)))/Fs);

% cylinder poessure 15.9pC/bar as the charge set up and outout is 3.16V
% so the overall sensitivity is 3.16V/bar or 0.316V/MPa
Scp=0.316;
Pcy(j,.,i)=Data(1:N,1)/Scp;

end
end

for j=1:2,
for i=1:length(Ld),

ntdc1=nxi{j}{i}(1);
Pcy(j,ntdc1,i);
if Pcy(j,ntdc1,i)+1>=2.0,
ntdc(i)=ntdc1;
ks=2;
else
ntdc(i)=nxi{j}{i}(2);
ks=1;
end
if Erpm(j,i)>1800, K=10; P0=0.11; else K=6; P0=0.22;end
for k=1:K,

k2=(k-1)*2+1;
aindx=nxi{j}{i}(k2+ks:ks+k2+1);
rpm(k)=1/(diff(aindx)/Fs)*60;
aind=(aindx(1):aindx(2)+1)';

```

```

    angw=(0:length(aind)-1)*360/length(aind);
    ntDCx=find(angw>=(180-dTDC));
    Pw=Pcy(j,aind-ntDCx(1),i);

angw=angw+180;
ang=angw/360*2*pi;
dang1=ang(2)-ang(1);
V1=Vc1+A1*R1*(1+lam1-cos(ang)-sqrt(lam1.^2-sin(ang).^2));
dV11=R1*A1*sin(ang).*(1+(cos(ang)/lam1)./sqrt(1-(sin(ang)/lam1).^2))*dang1; %
dV1=[0; diff(V1)];

figure(2),clf
ang1=(0:N-1)/Fs*mean(Erpm(j,i))*360/60;
atdc1=ang1(ntdc(i))+dTDC; % real TDC position

plot(ang1-atdc1,Pcy(j,:,i)),
xlabel('Crankshaft angle(deg.)')
ylabel('Pressure (MPa)')
set(gca,'xtick',0:2*360:42*2*360)
title([num2str(Erpm(j,i)) 'rpm'])
grid

Pws=sort(Pw);
Pmin=mean(Pws(2:5));
% work
w11=sum((Pw-Pmin+P0).*dV11)*1e6; % Nm

IMEPx(k,i)=w11/V10*1e-5; % unit in bar

% power
ip11(k,i)=w11/2*mean(Erpm(j,i))/60*4/1000;

end
nu=find(ip11(:,i)> mean(ip11(:,i)));
IMEP(i,j)=mean(IMEPx(nu,i));
ip11m(i,j)=mean(ip11(nu,i));
ip11s(i,j)=std(ip11(nu,i));

%measured power
bp11(i,j)=mean(Erpm(j,i))/60*2*pi*Ld(i)/1000;
ww=mean(Erpm(j,i))/60*2*pi;
BMEP(i,j)=Ld(i)*2*2*pi/V10*1e-5/4; % unit in bar
end

```



```

end

figure(3),clf
subplot(311),
plot(Ld,ip11m(:,1),'o-b',Ld,ip11m(:,2),'d-m')
hold on
plot(Ld,bp11(:,1),'*--b',Ld,bp11(:,2),'p--m')
xlabel('Load(Nm)')
legend({'IP1000', 'IP2000','BP1000','BP2000'})
ylabel('Power(kW)')
grid
subplot(312)
plot(Ld,ip11s(:,1),'o-b',Ld,ip11s(:,2),'d-m')
xlabel('Load(Nm)')
legend({'IP1000', 'IP2000'})
ylabel('ST(kW)')

subplot(313),
plot(Ld,IMEP(:,1),'o-b',Ld,IMEP(:,2),'d-m')
hold on
plot(Ld,BMEP(:,1),'*--b',Ld,BMEP(:,2),'p--m')
xlabel('Load(Nm)')
legend({'IP1000', 'IP2000','BP1000','BP2000'})
ylabel('xMEP(bar)')

```

ANNEXURE II

Factorial Fit: FP(kW) versus speed, load, viscosity

All factors with main effects, first order interaction and second order interaction

Estimated Effects and Coefficients for FP(kW) (coded units)

Term	Effect	Coef	SE Coef	T	P
Constant		4.733	0.1402	33.75	0.000
speed	5.016	2.508	0.1402	17.89	0.000
load	-3.876	-1.938	0.1402	-13.82	0.000
vis	0.794	0.397	0.1402	2.83	0.022
speed*load	-4.306	-2.153	0.1402	-15.35	0.000
speed*vis	0.834	0.417	0.1402	2.97	0.018
load*vis	-0.264	-0.132	0.1402	-0.94	0.375
speed*load*vis	-0.394	-0.197	0.1402	-1.40	0.198

S = 0.560909 PRESS = 10.0678
R-Sq = 98.97% R-Sq(pred) = 95.87% R-Sq(adj) = 98.06%

Analysis of Variance for FP(kW) (coded units)

Source	DF	Seq SS	Adj SS	Adj MS	F	P
Main Effects	3	163.272	163.272	54.4242	172.98	0.000
2-Way Interactions	3	77.234	77.234	25.7447	81.83	0.000
3-Way Interactions	1	0.620	0.620	0.6202	1.97	0.198
Residual Error	8	2.517	2.517	0.3146		
Pure Error	8	2.517	2.517	0.3146		
Total	15	243.644				

ANNEXURE III

Factorial Fit: FP(kW) versus speed, load, viscosity

Significant factors and its interactions

Estimated Effects and Coefficients for FP(kW) (coded units)

Term	Effect	Coef	SE Coef	T	P
Constant		4.733	0.1461	32.40	0.000
speed	5.016	2.508	0.1461	17.17	0.000
load	-3.876	-1.938	0.1461	-13.27	0.000
vis	0.794	0.397	0.1461	2.72	0.022
speed*load	-4.306	-2.153	0.1461	-14.74	0.000
speed*vis	0.834	0.417	0.1461	2.85	0.017

S = 0.584411 PRESS = 8.74333
R-Sq = 98.60% R-Sq(pred) = 96.41% R-Sq(adj) = 97.90%

Analysis of Variance for FP(kW) (coded units)

Source	DF	Seq SS	Adj SS	Adj MS	F	P
Main Effects	3	163.272	163.272	54.4242	159.35	0.000
2-Way Interactions	2	76.956	76.956	38.4779	112.66	0.000
Residual Error	10	3.415	3.415	0.3415		
Lack of Fit	2	0.898	0.898	0.4492	1.43	0.295
Pure Error	8	2.517	2.517	0.3146		
Total	15	243.644				